



THE DATASHEET OF TS507IYLT



High precision rail-to-rail operational amplifier

Datasheet - production data

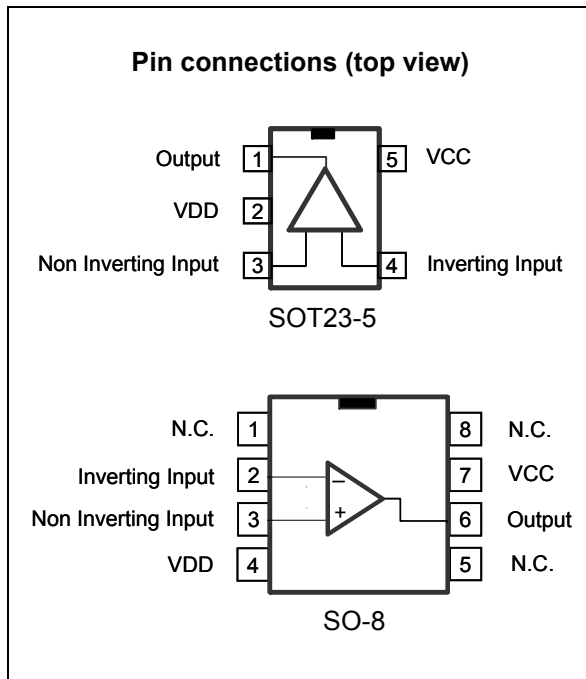

Applications

- Battery-powered applications
- Portable devices
- Signal conditioning
- Medical instrumentation

Description

The TS507 is a high performance rail-to-rail input/output amplifier with very low offset voltage. This amplifier uses a new trimming technique that yields ultra low offset voltages without any need for external zeroing.

The circuit offers very stable electrical characteristics over the entire supply voltage range, and is particularly intended for automotive and industrial applications.

The TS507 is housed in the space-saving 5-pin SOT23 package, making it well suited for battery-powered systems. This micropackage simplifies the PC board design because of its ability to be placed in small spaces (external dimensions are 2.8 mm x 2.9 mm).

Features

- Ultra low offset voltage: 25 μV typ, 100 μV max
- Rail-to-rail input/output voltage swing
- Operates from 2.7 V to 5.5 V
- High speed: 1.9 MHz
- 45° phase margin with 100 pF
- Low consumption: 0.8 mA at 2.7 V
- Very large signal voltage gain: 131 dB
- High-power supply rejection ratio: 105 dB
- Very high ESD protection 5kV (HBM)
- Latchup immunity
- Available in SOT23-5 micropackage
- Automotive qualification

Contents

- 1 Absolute maximum ratings and operating conditions 3**
- 2 Electrical characteristics 4**
- 3 Application note 15**
 - 3.1 Out-of-the-loop compensation technique 15
 - 3.2 In-the-loop-compensation technique 16
- 4 Package information 17**
 - 4.1 SOT23-5 package information 17
 - 4.2 SO-8 package 18
- 5 Ordering information 19**
- 6 Revision history 19**

1 Absolute maximum ratings and operating conditions

Table 1. Absolute maximum ratings (AMR)

Symbol	Parameter	Value	Unit
V_{CC}	Supply voltage ⁽¹⁾	6	V
V_{id}	Differential input voltage ⁽²⁾	± 2.5	
V_{in}	Input voltage ⁽³⁾	$V_{DD}-0.3$ to $V_{CC}+0.3$	
T_{stg}	Storage temperature	-65 to +150	°C
R_{thja}	Thermal resistance junction to ambient ⁽⁴⁾⁽⁵⁾		°C/W
	SOT23-5	250	
SO-8	125		
R_{thjc}	Thermal resistance junction to case		°C/W
	SOT23-5	81	
SO-8	40		
T_j	Maximum junction temperature	150	°C
ESD	HBM: human body model ⁽⁶⁾	5	kV
	MM: machine model ⁽⁷⁾	300	V
	CDM: charged device model ⁽⁸⁾	2	kV
	Latchup immunity	class A	

- Value with respect to V_{DD} pin.
- Differential voltages are the non-inverting input terminal with respect to the inverting input terminal.
- $V_{CC}-V_{in}$ and V_{in} must not exceed 6 V.
- Short-circuits can cause excessive heating and destructive dissipation.
- $R_{thja/c}$ are typical values.
- Human body model: A 100 pF capacitor is charged to the specified voltage, then discharged through a 1.5 k Ω resistor between two pins of the device. This is done for all couples of connected pin combinations while the other pins are floating.
- Machine model: A 200 pF capacitor is charged to the specified voltage, then discharged directly between two pins of the device with no external series resistor (internal resistor < 5 Ω). This is done for all couples of connected pin combinations while the other pins are floating.
- Charged device model: all pins and the package are charged together to the specified voltage and then discharged directly to the ground through only one pin. This is done for all pins.

Table 2. Operating conditions

Symbol	Parameter	Value	Unit
V_{CC}	Supply voltage ⁽¹⁾	2.7 to 5.5	V
V_{icm}	Common mode input voltage range	V_{DD} to V_{CC}	
V_{id}	Differential input voltage ⁽²⁾	± 2.5	
T_{oper}	Operating free air temperature range		°C
	TS507C	0 to +85	
	TS507I	-40 to +125	

- Value with respect to V_{DD} pin.
- Differential voltages are the non-inverting input terminal with respect to the inverting input terminal.

2 Electrical characteristics

Table 3. Electrical characteristics at $V_{CC} = +5\text{ V}$, $V_{DD} = 0\text{ V}$, $V_{icm} = V_{CC}/2$, $T_{amb} = 25\text{ °C}$, R_L connected to $V_{CC}/2$ (unless otherwise specified)⁽¹⁾

Symbol	Parameter	Conditions	Min.	Typ.	Max.	Unit
DC performance						
V_{io}	Input offset voltage ⁽²⁾	$V_{icm} = 0$ to 3.8 V , $T=25\text{ °C}$ TS507C full temperature range TS507I full temperature range		25	100 250 400	μV
		$V_{icm} = 0\text{ V}$ to 5 V , $T=25\text{ °C}$ TS507C full temperature range TS507I full temperature range			450 550 750	
$\Delta V_{io}/\Delta t$	V_{io} drift vs. temperature	$T_{min} < T_{op} < T_{max}$		1		$\mu\text{V}/\text{°C}$
I_{ib}	Input bias current	$T = 25\text{ °C}$ TS507C full temperature range TS507I full temperature range		8	70 75 110	nA
		$T = 25\text{ °C}$ TS507C full temperature range TS507I full temperature range		2	25 35 50	
CMRR	Common mode rejection ratio $20 \log (\Delta V_{icm}/\Delta V_{io})$	V_{icm} from 0 V to 3.8 V , $T=25\text{ °C}$ TS507C full temperature range TS507I full temperature range	94 94 91	115		dB
		V_{icm} from 0 V to 5 V		96		
PSRR	Power supply rejection ratio $20 \log (\Delta V_{CC}/\Delta V_{io})$	V_{CC} from 2.7 V to 5.5 V , $V_{icm}=V_{CC}/2$, $T=25\text{ °C}$ TS507C full temperature range TS507I full temperature range	91 90 89	105		dB
A_{vd}	Large signal voltage gain	$R_L = 10\text{ k}\Omega$, $V_{out} = 0.5\text{ V}$ to 4.5 V Full temperature range	99 98	131		
$V_{CC}-V_{OH}$	High level output voltage drop	$R_L = 600\Omega$, $T=25\text{ °C}$ TS507C full temperature range TS507I full temperature range		67	95 110 120	mV
		$R_L = 10\text{ k}\Omega$, $T=25\text{ °C}$ Full temperature range		4	15 15	
V_{OL}	Low level output voltage	$R_L = 600\ \Omega$, $T=25\text{ °C}$ TS507C full temperature range TS507I full temperature range		64	90 110 125	mV
		$R_L = 10\text{ k}\Omega$, $T=25\text{ °C}$ Full temperature range		4	15 15	

Table 3. Electrical characteristics at $V_{CC} = +5\text{ V}$, $V_{DD} = 0\text{ V}$, $V_{icm} = V_{CC}/2$, $T_{amb} = 25\text{ °C}$, R_L connected to $V_{CC}/2$ (unless otherwise specified)⁽¹⁾ (continued)

Symbol	Parameter	Conditions	Min.	Typ.	Max.	Unit
I_{out}	I_{sink}	$V_{out} = V_{CC}$, $V_{id} = -1\text{ V}$, $T = 25\text{ °C}$ TS507C full temperature range TS507I full temperature range	74 60 53	104		mA
	I_{source}	$V_{out} = V_{DD}$, $V_{id} = 1\text{ V}$, $T = 25\text{ °C}$ TS507C full temperature range TS507I full temperature range	90 77 70	128		
I_{CC}	Supply current (per operator) ⁽²⁾	No load, $V_{out} = V_{CC}/2$, $V_{icm} = 0$ to 5 V , $T = 25\text{ °C}$ Full temperature range		0.85	1.15 1.25	
Dynamic performance						
GBP	Gain bandwidth product	$R_L = 2\text{ k}\Omega$, $C_L = 100\text{ pF}$, $f = 100\text{ kHz}$		1.9		MHz
ϕ_m	Phase margin	$R_L = 2\text{ k}\Omega$, $C_L = 100\text{ pF}$		45		Degrees
G_m	Gain margin			10		dB
SR	Slew rate	$R_L = 2\text{ k}\Omega$, $C_L = 100\text{ pF}$, $V_{out} = 1.25\text{ V}$ to 3.75 V , 10% to 90%		0.6		V/ μ s
e_N	Equivalent input noise voltage	$f = 1\text{ kHz}$		12		nV/ $\sqrt{\text{Hz}}$
i_N	Equivalent input noise current	$f = 10\text{ kHz}$		1.2		pA/ $\sqrt{\text{Hz}}$
THD+ e_N	THD + noise	$f = 1\text{ kHz}$, $G = 1$, $R_L = 2\text{ k}\Omega$, $V_{icm} = 2\text{ V}$, $V_{out} = 3.5\text{ V}_{pp}$		0.0003		%

1. All parameter limits at temperatures different from 25 °C are guaranteed by correlation.

2. Measurements made at 4 V_{icm} values: $V_{icm} = 0\text{ V}$, $V_{icm} = 3.8\text{ V}$, $V_{icm} = 4.2\text{ V}$, $V_{icm} = 5\text{ V}$.

Table 4. Electrical characteristics at $V_{CC} = +3.3\text{ V}$, $V_{DD} = 0\text{ V}$, $V_{icm} = V_{CC}/2$, $T_{amb} = 25\text{ }^\circ\text{C}$, R_L connected to $V_{CC}/2$ (unless otherwise specified)⁽¹⁾

Symbol	Parameter	Conditions	Min.	Typ.	Max.	Unit
DC performance						
V_{io}	Input offset voltage ⁽²⁾	$V_{icm} = 0$ to 2.1 V , $T=25\text{ }^\circ\text{C}$ TS507C full temperature range TS507I full temperature range		25	100 250 400	μV
		$V_{icm} = 0\text{ V}$ to 3.3 V , $T=25\text{ }^\circ\text{C}$ TS507C full temperature range TS507I full temperature range			450 550 750	
ΔV_{io}	V_{io} drift vs. temperature	$T_{min} < T_{op} < T_{max}$		1		$\mu\text{V}/^\circ\text{C}$
I_{ib}	Input bias current	$T = 25\text{ }^\circ\text{C}$ TS507C full temperature range TS507I full temperature range		6	70 75 145	nA
I_{io}	Input offset current	$T = 25\text{ }^\circ\text{C}$ TS507C full temperature range TS507I full temperature range		2	25 40 45	
CMRR	Common mode rejection ratio $20 \log (\Delta V_{icm}/\Delta V_{io})$	V_{icm} from 0 V to 2.1 V		115		dB
A_{vd}	Large signal voltage gain	$R_L = 10\text{ k}\Omega$, $V_{out} = 0.5\text{ V}$ to 2.8 V		127		
$V_{CC}-V_{OH}$	High level output voltage drop	$R_L = 600\ \Omega$, $T=25\text{ }^\circ\text{C}$ TS507C full temperature range TS507I full temperature range		59	85 100 110	mV
		$R_L = 10\text{ k}\Omega$, $T=25\text{ }^\circ\text{C}$ Full temperature range		4	15 15	
V_{OL}	Low level output voltage	$R_L = 600\ \Omega$, $T=25\text{ }^\circ\text{C}$ TS507C full temperature range TS507I full temperature range		57	80 100 115	mV
		$R_L = 10\text{ k}\Omega$, $T=25\text{ }^\circ\text{C}$ Full temperature range		4	15 15	
I_{out}	I_{sink}	$V_{out} = V_{CC}$, $V_{id} = -1\text{ V}$, $T=25\text{ }^\circ\text{C}$ TS507C full temperature range TS507I full temperature range	33 26 22	48		mA
	I_{source}	$V_{out} = V_{DD}$, $V_{id} = 1\text{ V}$, $T=25\text{ }^\circ\text{C}$ TS507C full temperature range TS507I full temperature range	37 32 29	56		
I_{CC}	Supply current (per operator) ⁽²⁾	No load, $V_{out} = V_{CC}/2$, $V_{icm} = 0$ to 3.3 V , $T=25\text{ }^\circ\text{C}$ Full temperature range		0.81	1.1 1.2	

Table 4. Electrical characteristics at $V_{CC} = +3.3\text{ V}$, $V_{DD} = 0\text{ V}$, $V_{icm} = V_{CC}/2$, $T_{amb} = 25\text{ °C}$, R_L connected to $V_{CC}/2$ (unless otherwise specified)⁽¹⁾ (continued)

Symbol	Parameter	Conditions	Min.	Typ.	Max.	Unit
Dynamic performance						
GBP	Gain bandwidth product	$R_L = 2\text{ k}\Omega$, $C_L = 100\text{ pF}$, $f = 100\text{ kHz}$		1.9		MHz
ϕ_m	Phase margin	$R_L = 2\text{ k}\Omega$, $C_L = 100\text{ pF}$		45		Degrees
G_m	Gain margin			10		dB
SR	Slew rate	$R_L = 2\text{ k}\Omega$, $C_L = 100\text{ pF}$, $V_{out} = 0.5\text{ V to } 2.8\text{ V}$, 10 % to 90 %		0.6		V/ μ s
e_N	Equivalent input noise voltage	$f = 1\text{ kHz}$		12		nV/ $\sqrt{\text{Hz}}$
THD+ e_N	THD + noise	$f = 1\text{ KHz}$, $G = 1$, $R_L = 2\text{ k}\Omega$, $V_{icm} = 1.15\text{ V}$, $V_{out} = 1.8\text{ V}_{pp}$		0.0004		%

1. All parameter limits at temperatures different from 25 ° C are guaranteed by correlation.
2. Measurements done at 4 V_{icm} values: $V_{icm} = 0\text{ V}$, $V_{icm} = 2.1\text{ V}$, $V_{icm} = 2.5\text{ V}$, $V_{icm} = 3.3\text{ V}$.

Table 5. Electrical characteristics at $V_{CC} = +2.7\text{ V}$, $V_{DD} = 0\text{ V}$, $V_{icm} = V_{CC}/2$, $T_{amb} = 25\text{ }^\circ\text{C}$, R_L connected to $V_{CC}/2$ (unless otherwise specified)⁽¹⁾

Symbol	Parameter	Conditions	Min.	Typ.	Max.	Unit
DC performance						
V_{io}	Input offset voltage ⁽²⁾	$V_{icm} = 0$ to 1.9 V , $T=25\text{ }^\circ\text{C}$ TS507C full temperature range TS507I full temperature range		25	100 250 400	μV
		$V_{icm} = 0\text{ V}$ to 2.7 V , $T=25\text{ }^\circ\text{C}$ TS507C full temperature range TS507I full temperature range			450 550 750	
ΔV_{io}	V_{io} drift vs. temperature	$T_{min} < T_{op} < T_{max}$		1		$\mu\text{V}/^\circ\text{C}$
I_{ib}	Input bias current	$T = 25\text{ }^\circ\text{C}$ TS507C full temperature range TS507I full temperature range		8	70 75 160	nA
I_{io}	Input offset current	$T = 25\text{ }^\circ\text{C}$ TS507C full temperature range TS507I full temperature range		2	25 45 45	
CMRR	Common mode rejection ratio $20 \log (\Delta V_{icm}/\Delta V_{io})$	V_{icm} from 0 V to 1.5 V		115		dB
A_{vd}	Large signal voltage gain	$R_L = 10\text{ k}\Omega$, $V_{out} = 0.5\text{ V}$ to 2.2 V		126		
$V_{CC}-V_{OH}$	High level output voltage drop	$R_L = 600\text{ }\Omega$, $T=25\text{ }^\circ\text{C}$ TS507C full temperature range TS507I full temperature range		57	85 100 105	mV
		$R_L = 10\text{ k}\Omega$, $T=25\text{ }^\circ\text{C}$ Full temperature range		4	15 15	
V_{OL}	Low level output voltage	$R_L = 600\text{ }\Omega$, $T=25\text{ }^\circ\text{C}$ TS507C full temperature range TS507I full temperature range		57	80 100 115	mV
		$R_L = 10\text{ k}\Omega$, $T=25\text{ }^\circ\text{C}$ Full temperature range		4	15 15	
I_{out}	I_{sink}	$V_{out} = V_{CC}$, $V_{id} = -1\text{ V}$, $T=25\text{ }^\circ\text{C}$ TS507C full temperature range TS507I full temperature range	20 15 13	30		mA
	I_{source}	$V_{out} = V_{DD}$, $V_{id} = 1\text{ V}$, $T=25\text{ }^\circ\text{C}$ TS507C full temperature range TS507I full temperature range	22 19 17	35		
I_{CC}	Supply current (per operator) ⁽²⁾	No load, $V_{out} = V_{CC}/2$, $V_{icm} = 0$ to 2.7 V , $T=25\text{ }^\circ\text{C}$ Full temperature range		0.79	1.1 1.2	

Table 5. Electrical characteristics at $V_{CC} = +2.7\text{ V}$, $V_{DD} = 0\text{ V}$, $V_{icm} = V_{CC}/2$, $T_{amb} = 25\text{ °C}$, R_L connected to $V_{CC}/2$ (unless otherwise specified)⁽¹⁾ (continued)

Symbol	Parameter	Conditions	Min.	Typ.	Max.	Unit
Dynamic performance						
GBP	Gain bandwidth product	$R_L = 2\text{ k}\Omega$, $C_L = 100\text{ pF}$, $f = 100\text{ kHz}$		1.9		MHz
ϕ_m	Phase margin	$R_L = 2\text{ k}\Omega$, $C_L = 100\text{ pF}$		45		Degrees
G_m	Gain margin			11		dB
SR	Slew rate	$R_L = 2\text{ k}\Omega$, $C_L = 100\text{ pF}$, $V_{out} = 0.5\text{ V to } 2.2\text{ V}$, 10 % to 90 %		0.6		V/ μ s
e_N	Equivalent input noise voltage	$f = 1\text{ kHz}$		12		nV/ $\sqrt{\text{Hz}}$
THD+ e_N	THD + noise	$f = 1\text{ kHz}$, $G = 1$, $R_L = 2\text{ k}\Omega$, $V_{icm} = 0.85\text{ V}$, $V_{out} = 1.2\text{ V}_{pp}$		0.0005		%

1. All parameter limits at temperatures different from 25 ° C are guaranteed by correlation.
2. Measurements done at 4 V_{icm} values: $V_{icm} = 0\text{ V}$, $V_{icm} = 1.5\text{ V}$, $V_{icm} = 1.9\text{ V}$, $V_{icm} = 2.7\text{ V}$.

Figure 1. Input offset voltage distribution for $V_{icm} \leq V_{CC}-1.2V$ at $T=25^\circ C$

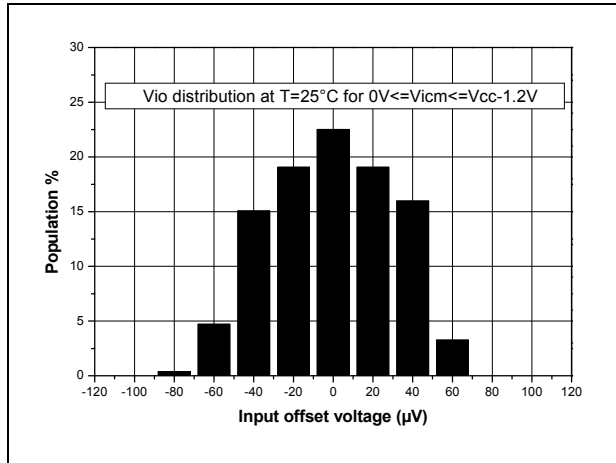

Figure 2. Input offset voltage distribution vs. temperature for $V_{icm} \leq V_{CC}-1.2V$

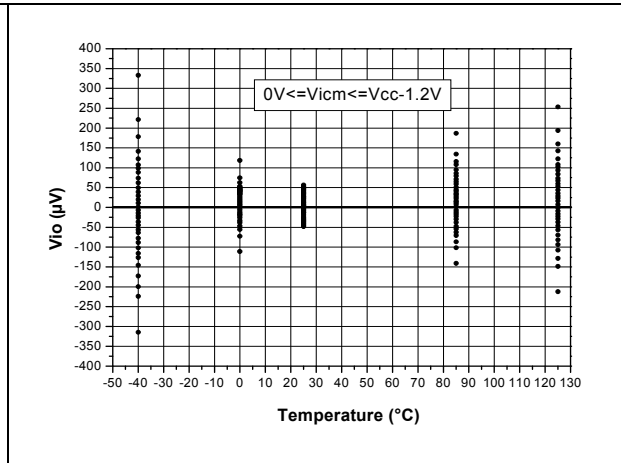

Figure 3. Input offset voltage distribution vs. temperature for $V_{icm} \geq V_{CC}-0.8V$

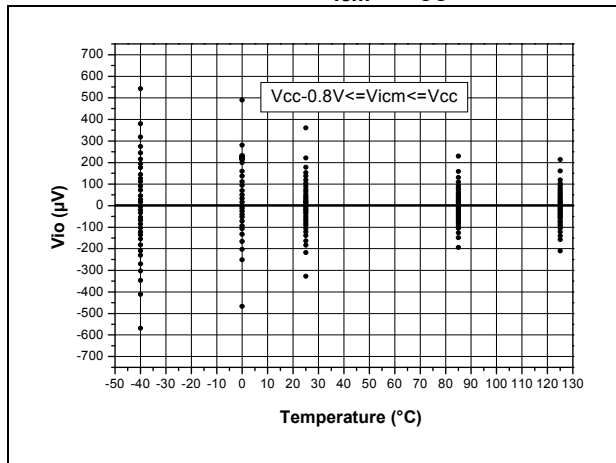

Figure 4. Input offset voltage distribution for $V_{icm} \leq V_{CC}-1.2V$ at $T=25^\circ C$ after HTB

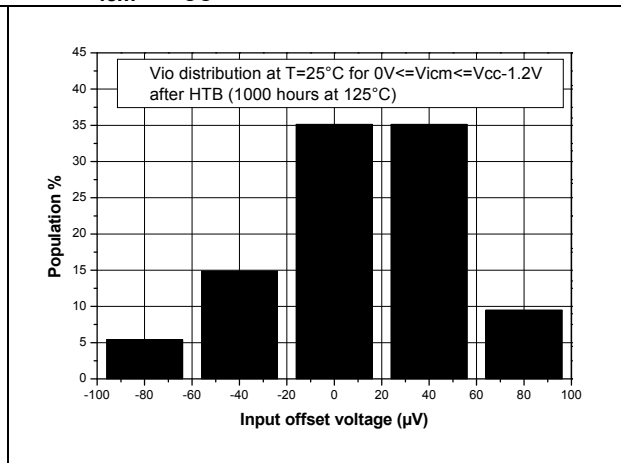

Figure 5. Input offset voltage distribution for $V_{icm} \leq V_{CC}-1.2V$ at $T=25^\circ C$ after THB

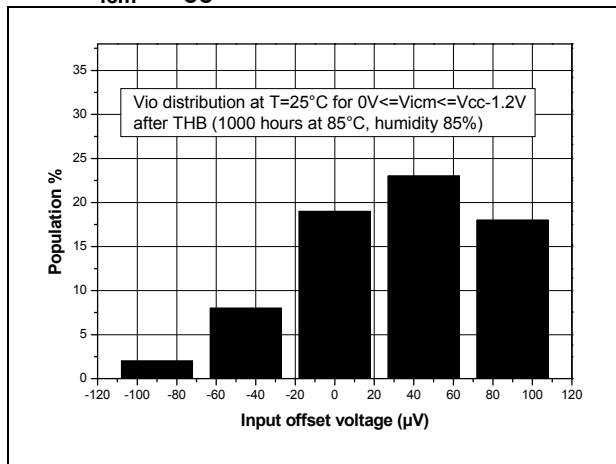

Figure 6. Input offset voltage vs. input common mode voltage at $T=25^\circ C$

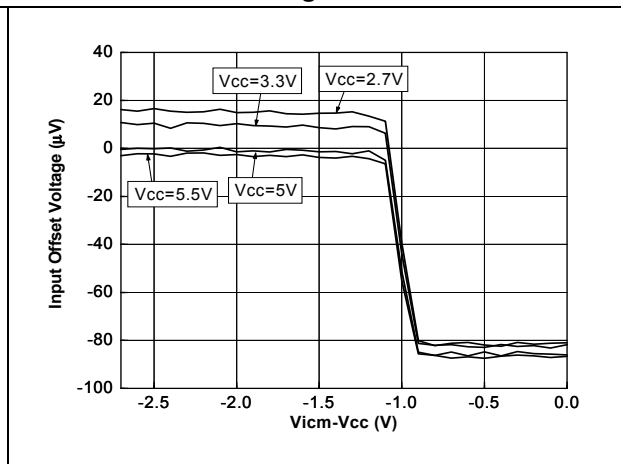

Figure 7. Supply current vs. input common mode voltage in closed loop configuration at $V_{CC}=5\text{ V}$

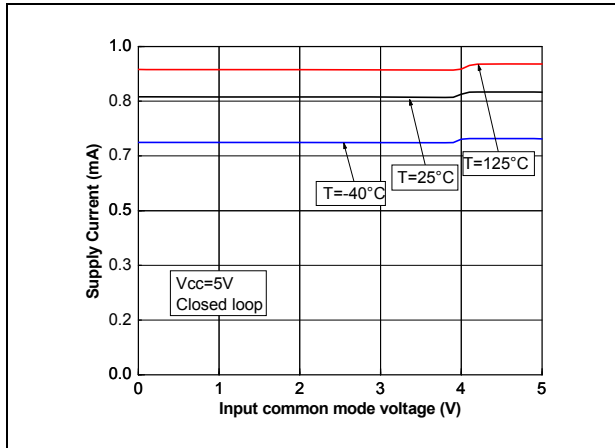

Figure 8. Supply current vs. supply voltage at $V_{icm}=V_{CC}/2$

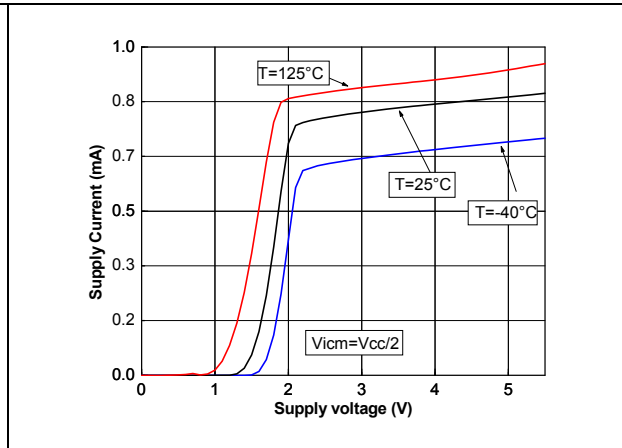

Figure 9. Supply current vs. input common mode voltage in follower configuration at $V_{CC}=2.7\text{ V}$

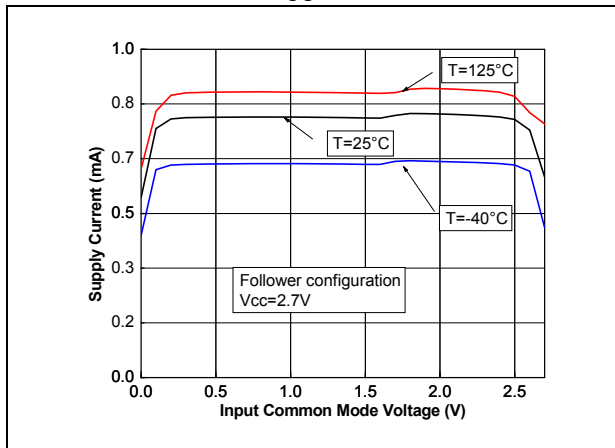

Figure 10. Supply current vs. input common mode voltage in follower configuration at $V_{CC}=5\text{ V}$

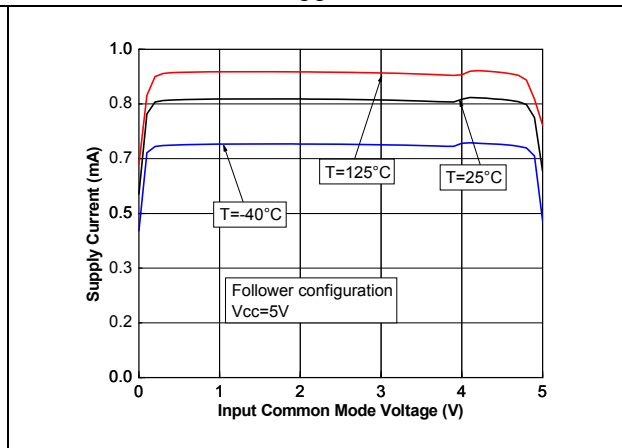

Figure 11. Output current vs. supply voltage at $V_{icm}=V_{CC}/2$

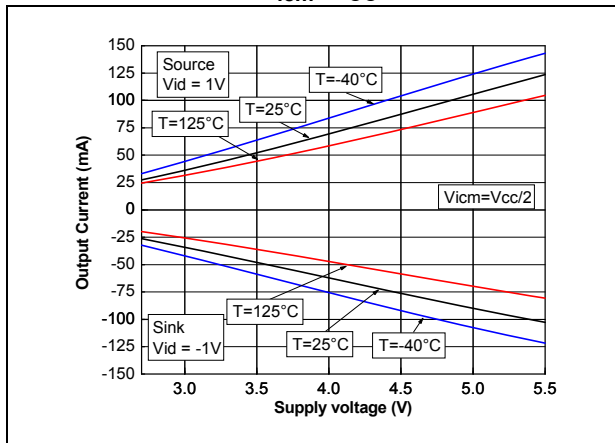

Figure 12. Output current vs. output voltage at $V_{CC}=2.7\text{ V}$

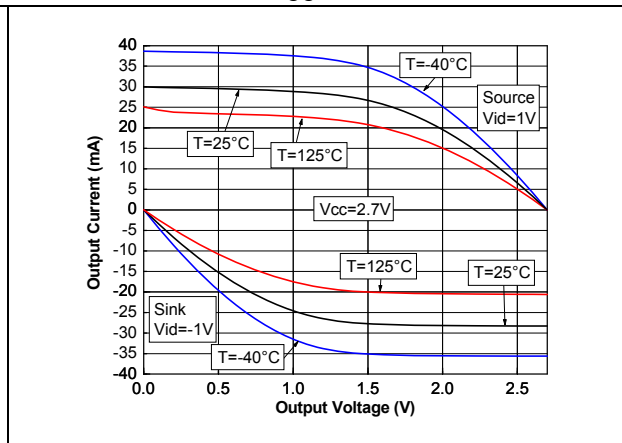

Figure 13. Output current vs. output voltage at $V_{CC}=5\text{ V}$

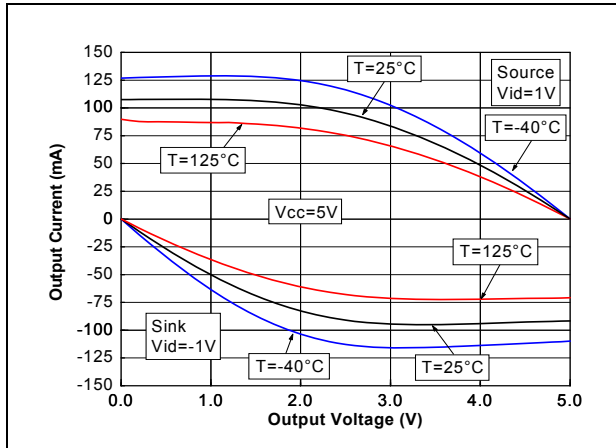

Figure 14. Positive and negative slew rate vs. supply voltage

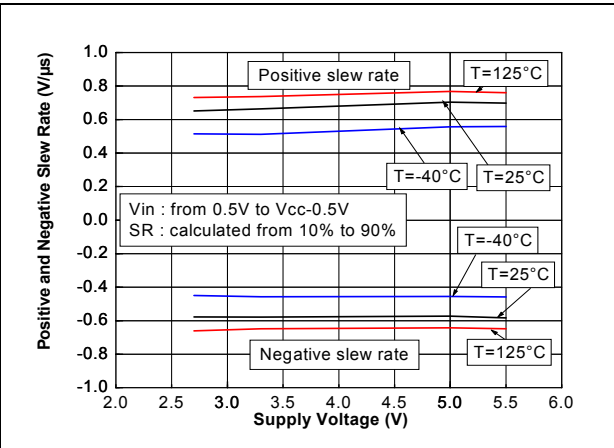

Figure 15. Voltage gain and phase vs. frequency at $V_{CC}=5\text{ V}$ and $V_{icm}=2.5\text{ V}$ at $T=25\text{ °C}$

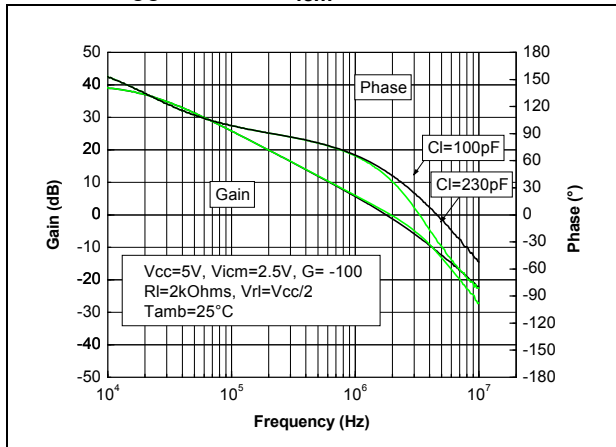

Figure 16. Voltage gain and phase vs. frequency at $V_{CC}=5\text{ V}$ and $V_{icm}=2.5\text{ V}$ at $T=-40\text{ °C}$

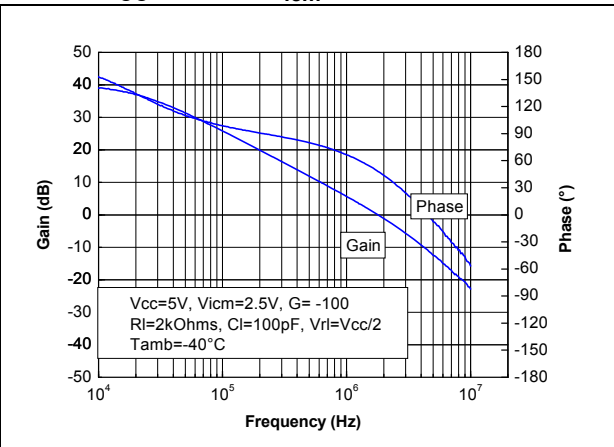

Figure 17. Voltage gain and phase vs. frequency at $V_{CC}=5\text{ V}$ and $V_{icm}=2.5\text{ V}$ at $T=125\text{ °C}$

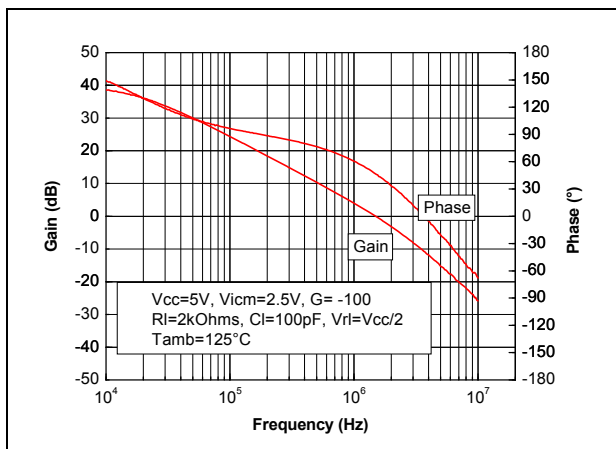

Figure 18. Closed loop gain in voltage follower configuration for different capacitive load at $T=25\text{ °C}$

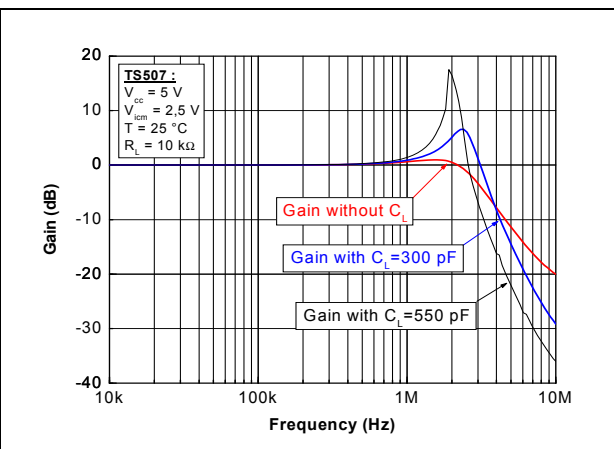

Figure 19. Gain margin according to the output load, at $V_{CC}=5\text{ V}$ and $T=25\text{ }^\circ\text{C}$

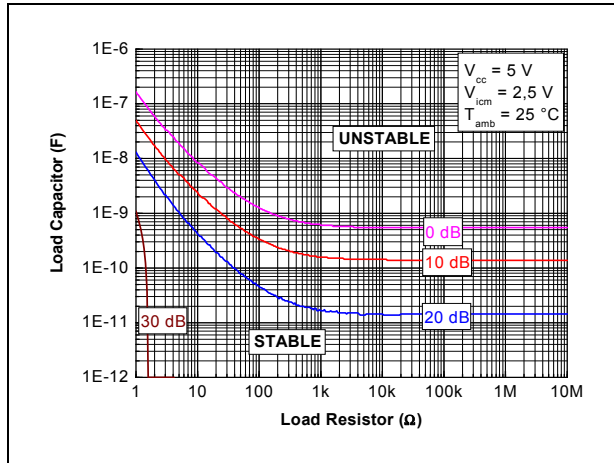

Figure 20. Phase margin according to the output load, at $V_{CC}=5\text{ V}$ and $T=25\text{ }^\circ\text{C}$

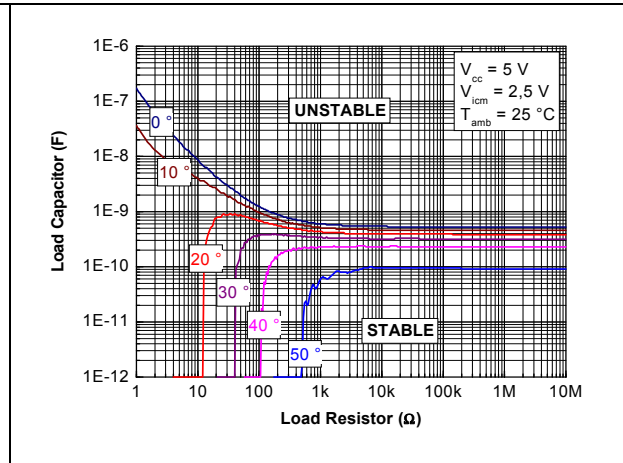

Figure 21. Gain margin vs. output current, at $V_{CC}=5\text{ V}$ and $T=25\text{ }^\circ\text{C}$

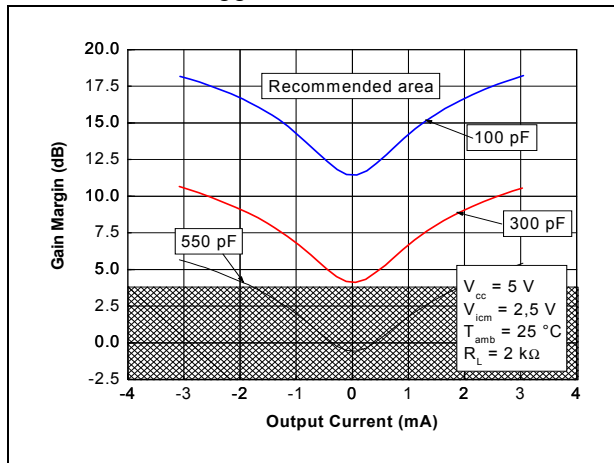

Figure 22. Phase margin vs. output current, at $V_{CC}=5\text{ V}$ and $T=25\text{ }^\circ\text{C}$

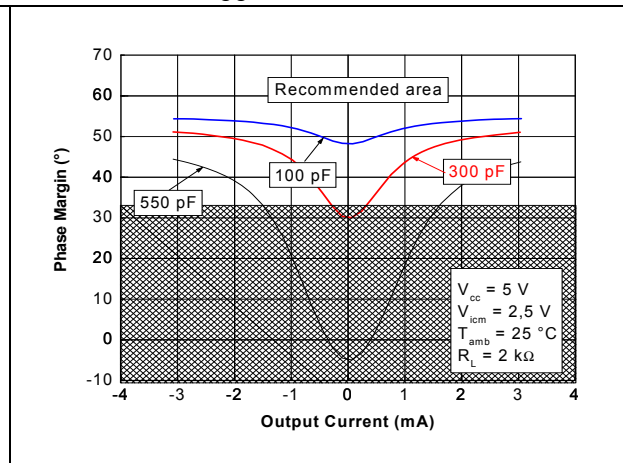

Figure 23. Phase and gain margins vs capacitive load at $= 25\text{ }^\circ\text{C}$

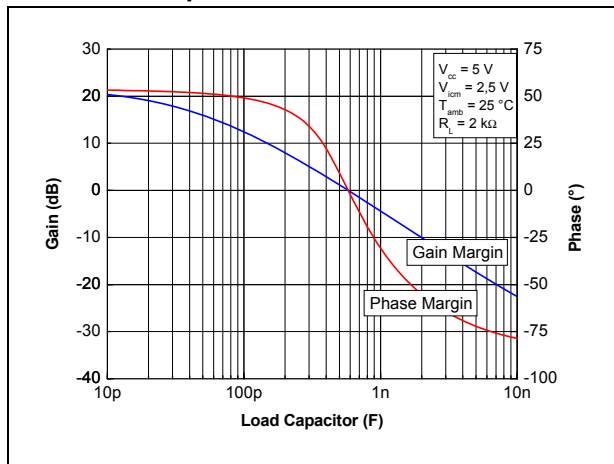

Figure 24. Distortion + noise vs. output voltage

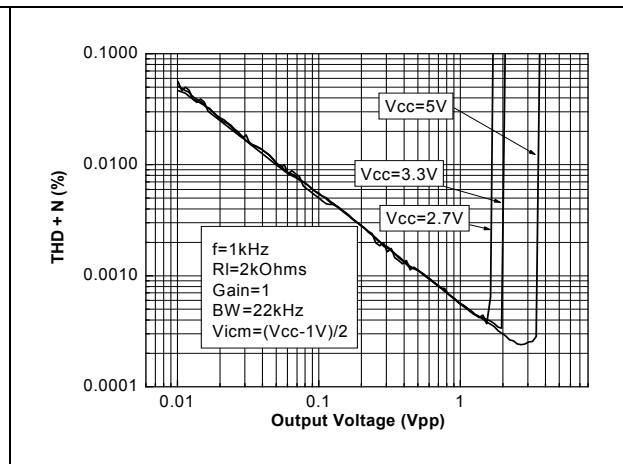

Figure 25. Distortion + noise vs. frequency

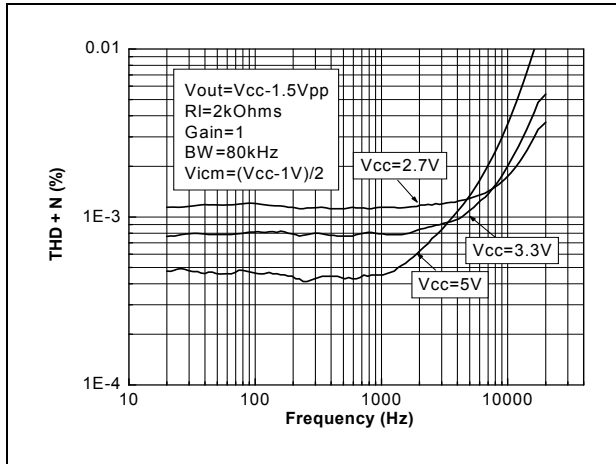
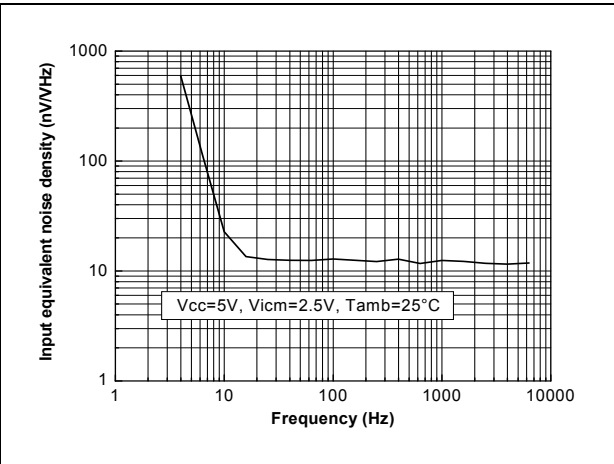

Figure 26. Noise vs. frequency



3 Application note

The application note AN2653, based on the TS507, describes three compensation techniques for solving stability issues when driving large capacitive loads. Two of these techniques are briefly explained below. For more details, refer to the AN2653 on: www.st.com.

3.1 Out-of-the-loop compensation technique

The first technique, named **out-of-the-loop** compensation, uses an isolation resistor, R_{OL} , added in series between the output of the amplifier and its load (see *Figure 27*). The resistor isolates the op-amp feedback network from the capacitive load. This compensation method is effective, but the drawback is a limitation on the accuracy of V_{out} depending on the resistive load value.

Figure 27. Out-of-the-loop compensation schematics

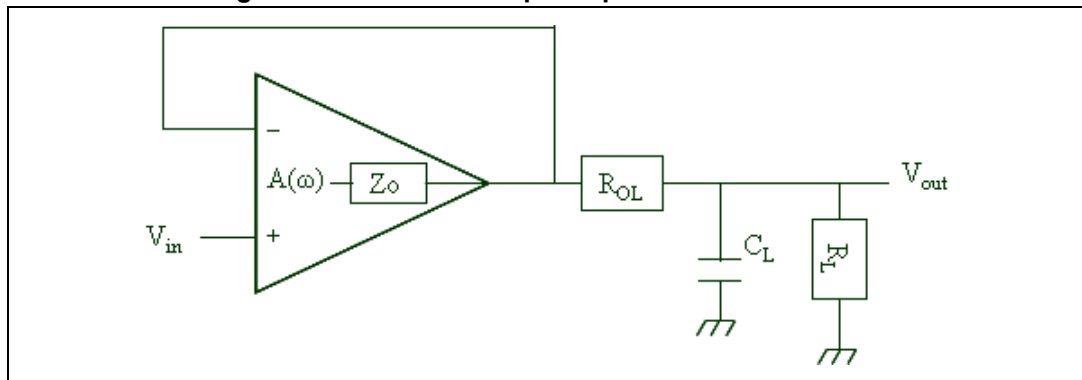

To help implement the compensation, the abacus given in *Figure 28* and *Figure 29* provides the R_{OL} value to be chosen for a given C_L and phase/gain margins. These abacus are plotted for voltage follower configuration with a load resistor of 10 kΩ at 25 °C.

Figure 28. Gain margin abacus: serial resistor to be added in a voltage follower configuration at 25 °C

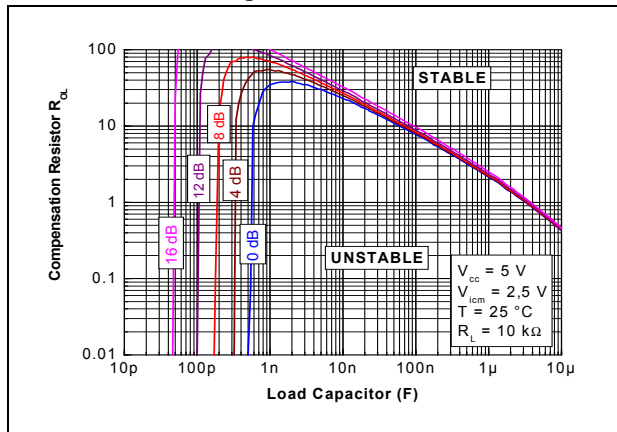
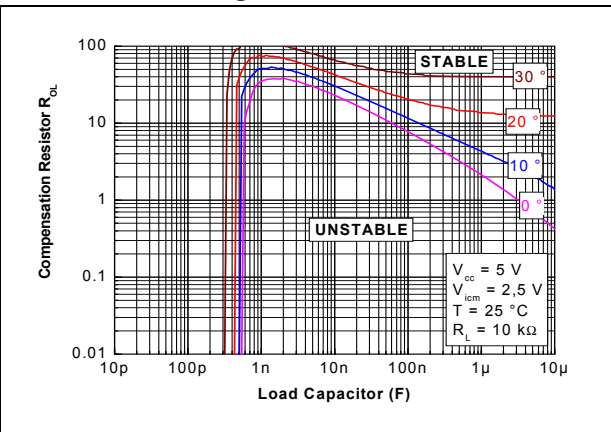

Figure 29. Phase margin abacus: serial resistor to be added in a voltage follower configuration at 25 °C



3.2 In-the-loop-compensation technique

The second technique is called **in-the-loop-compensation** technique, because the additional components (a resistor and a capacitor) used to improve the stability are inserted in the feedback loop (see [Figure 30](#)).

Figure 30. In-the-loop compensation schematics

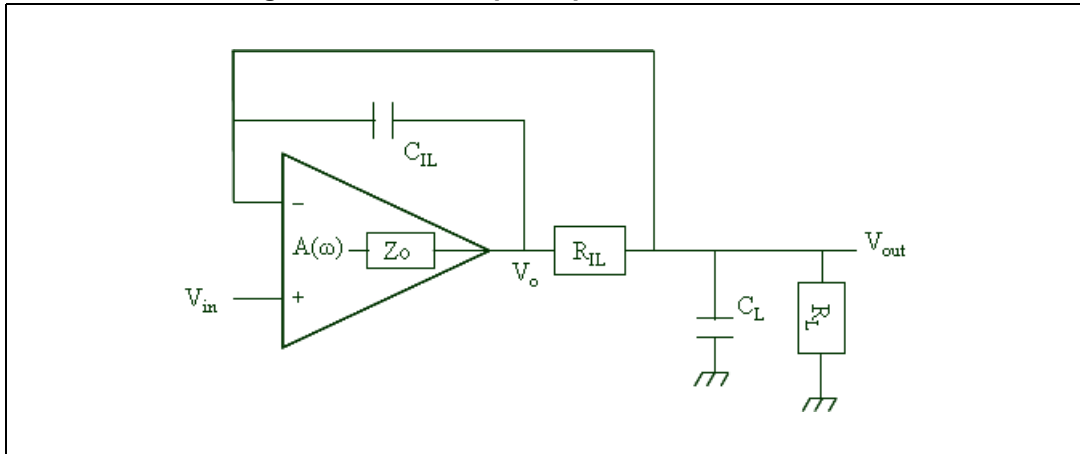

This compensation method allows (by a good choice of compensation components) the original pole caused by the capacitive load to be compensated. Stability is thus improved.

The main drawback of this circuit is the reduction of the output swing, because the isolation resistor is in the signal path.

[Table 6](#) shows the best compensation components for different ranges of load capacitors (with $R_L = 10\text{ k}\Omega$) in voltage follower configuration.

Table 6. Best compensation components for different load capacitor ranges in voltage follower configuration for TS507 (with $R_L = 10\text{ k}\Omega$)

Load capacitor range	R_{IL} (k Ω)	C_{IL} (pF)	Minimum gain margin (dB) ⁽¹⁾	Minimum phase margin (degree) ⁽¹⁾
10 pF to 100 pF	1	250	17	55
100 pF to 1 nF	1	250	16	42
1 nF to 10 nF	1	630	11	27

1. Parameter guaranteed by design at 25 °C.

4 Package information

In order to meet environmental requirements, ST offers these devices in different grades of ECOPACK[®] packages, depending on their level of environmental compliance. ECOPACK[®] specifications, grade definitions and product status are available at: www.st.com. ECOPACK[®] is an ST trademark.

4.1 SOT23-5 package information

Figure 31. SOT23-5 package mechanical drawing

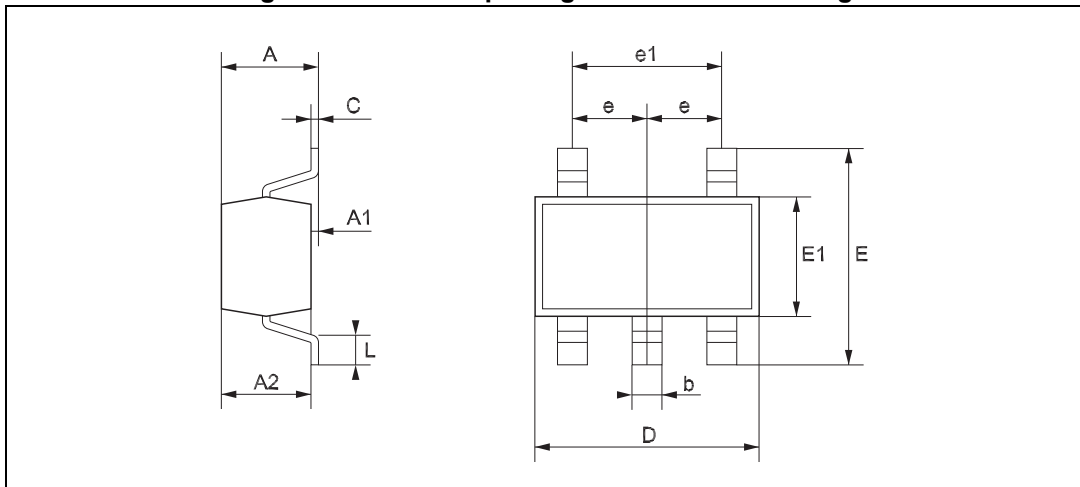

Table 7. SOT23-5 package mechanical data

Ref.	Dimensions					
	Millimeters			Mils		
	Min.	Typ.	Max.	Min.	Typ.	Max.
A	0.90		1.45	35.4		57.1
A1	0.00		0.15	0.00		5.9
A2	0.90		1.30	35.4		51.2
b	0.35		0.50	13.7		19.7
C	0.09		0.20	3.5		7.8
D	2.80		3.00	110.2		118.1
E	2.60		3.00	102.3		118.1
E1	1.50		1.75	59.0		68.8
e		0.95			37.4	
e1		1.9			74.8	
L	0.35		0.55	13.7		21.6

4.2 SO-8 package

Figure 32. SO-8 package mechanical drawing

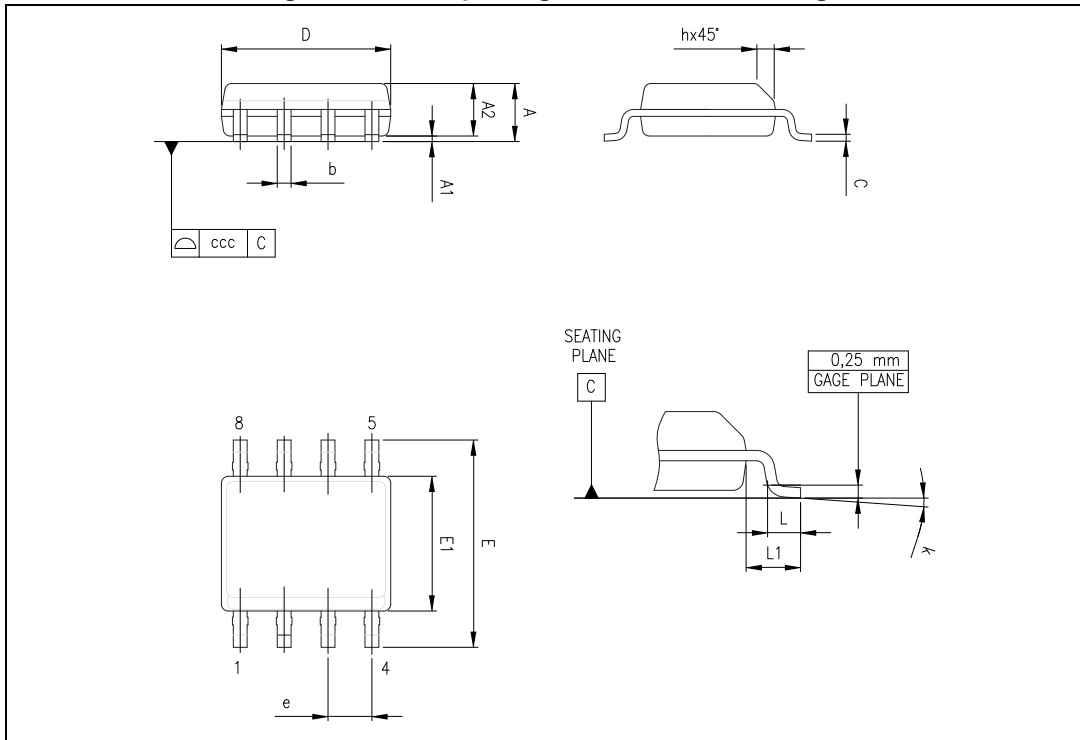

Table 8. SO-8 package mechanical data

Ref.	Dimensions					
	Millimeters			Inches		
	Min.	Typ.	Max.	Min.	Typ.	Max.
A			1.75			0.069
A1	0.10		0.25	0.004		0.010
A2	1.25			0.049		
b	0.28		0.48	0.011		0.019
c	0.17		0.23	0.007		0.010
D	4.80	4.90	5.00	0.189	0.193	0.197
E	5.80	6.00	6.20	0.228	0.236	0.244
E1	3.80	3.90	4.00	0.150	0.154	0.157
e		1.27			0.050	
h	0.25		0.50	0.010		0.020
L	0.40		1.27	0.016		0.050
k	1°		8°	1°		8°
ccc			0.10			0.004

5 Ordering information

Table 9. Order codes

Order code	Temperature range	Package	Packing	Marking
TS507ID TS507IDT	-40°C to 125 °C	SO-8	Tube or tape and reel	TS507I
TS507ILT	-40°C to 125 °C	SOT23-5 ⁽¹⁾	Tape and reel	K131
TS507IYLT ⁽²⁾		SOT23-5 ⁽¹⁾ (automotive grade)		K137
TS507CD TS507CDT	0°C to 85 °C	SO-8	Tube or tape and reel	TS507C
TS507CLT		SOT23-5 ⁽¹⁾	Tape and reel	K136

1. All information related to the SOT23-5 package is subject to change without notice.
2. Qualification and characterization according to AEC Q100 and Q003 or equivalent, advanced screening according to AEC Q001 & Q 002 or equivalent are qualified.

6 Revision history

Figure 33. Document revision history

Date	Revision	Changes
01-Oct-2004	1	Preliminary data release for product in development.
02-May-2006	2	Update preliminary data release for product in development.
15-Dec-2006	3	First public release.
03-May-2007	4	Automotive grade products added.
08-Apr-2008	5	Electrical characteristics curves for Bode and AC stability added and updated. Application note section added.
21-Mar-2013	6	<i>Features</i> : added automotive qualification Updated Table 9: Order codes

Please Read Carefully:

Information in this document is provided solely in connection with ST products. STMicroelectronics NV and its subsidiaries ("ST") reserve the right to make changes, corrections, modifications or improvements, to this document, and the products and services described herein at any time, without notice.

All ST products are sold pursuant to ST's terms and conditions of sale.

Purchasers are solely responsible for the choice, selection and use of the ST products and services described herein, and ST assumes no liability whatsoever relating to the choice, selection or use of the ST products and services described herein.

No license, express or implied, by estoppel or otherwise, to any intellectual property rights is granted under this document. If any part of this document refers to any third party products or services it shall not be deemed a license grant by ST for the use of such third party products or services, or any intellectual property contained therein or considered as a warranty covering the use in any manner whatsoever of such third party products or services or any intellectual property contained therein.

UNLESS OTHERWISE SET FORTH IN ST'S TERMS AND CONDITIONS OF SALE ST DISCLAIMS ANY EXPRESS OR IMPLIED WARRANTY WITH RESPECT TO THE USE AND/OR SALE OF ST PRODUCTS INCLUDING WITHOUT LIMITATION IMPLIED WARRANTIES OF MERCHANTABILITY, FITNESS FOR A PARTICULAR PURPOSE (AND THEIR EQUIVALENTS UNDER THE LAWS OF ANY JURISDICTION), OR INFRINGEMENT OF ANY PATENT, COPYRIGHT OR OTHER INTELLECTUAL PROPERTY RIGHT.

ST PRODUCTS ARE NOT AUTHORIZED FOR USE IN WEAPONS. NOR ARE ST PRODUCTS DESIGNED OR AUTHORIZED FOR USE IN: (A) SAFETY CRITICAL APPLICATIONS SUCH AS LIFE SUPPORTING, ACTIVE IMPLANTED DEVICES OR SYSTEMS WITH PRODUCT FUNCTIONAL SAFETY REQUIREMENTS; (B) AERONAUTIC APPLICATIONS; (C) AUTOMOTIVE APPLICATIONS OR ENVIRONMENTS, AND/OR (D) AEROSPACE APPLICATIONS OR ENVIRONMENTS. WHERE ST PRODUCTS ARE NOT DESIGNED FOR SUCH USE, THE PURCHASER SHALL USE PRODUCTS AT PURCHASER'S SOLE RISK, EVEN IF ST HAS BEEN INFORMED IN WRITING OF SUCH USAGE, UNLESS A PRODUCT IS EXPRESSLY DESIGNATED BY ST AS BEING INTENDED FOR "AUTOMOTIVE, AUTOMOTIVE SAFETY OR MEDICAL" INDUSTRY DOMAINS ACCORDING TO ST PRODUCT DESIGN SPECIFICATIONS. PRODUCTS FORMALLY ESCC, QML OR JAN QUALIFIED ARE DEEMED SUITABLE FOR USE IN AEROSPACE BY THE CORRESPONDING GOVERNMENTAL AGENCY.

Resale of ST products with provisions different from the statements and/or technical features set forth in this document shall immediately void any warranty granted by ST for the ST product or service described herein and shall not create or extend in any manner whatsoever, any liability of ST.

ST and the ST logo are trademarks or registered trademarks of ST in various countries.

Information in this document supersedes and replaces all information previously supplied.

The ST logo is a registered trademark of STMicroelectronics. All other names are the property of their respective owners.

© 2013 STMicroelectronics - All rights reserved



STMicroelectronics group of companies

Australia - Belgium - Brazil - Canada - China - Czech Republic - Finland - France - Germany - Hong Kong - India - Israel - Italy - Japan - Malaysia - Malta - Morocco - Philippines - Singapore - Spain - Sweden - Switzerland - United Kingdom - United States of America

www.st.com

Looking for pricing, stock, or lifecycle information?

Click below to explore more details on WIN SOURCE:

-  [View TS507IYLT](#) on WIN SOURCE
-  [STMicroelectronics](#) Information

Optimize Your Supply Chain with WIN SOURCE Solutions

-  Global Sourcing Solution
-  Obsolete Management
-  Cost Control Management
-  Shortage Management
-  Alternative Solution
-  Excess Inventory Management