



**THE DATASHEET OF  
IRS21091STRPBF**



## IRS21091(S)PbF

### HALF-BRIDGE DRIVER

#### Features

- Floating channel designed for bootstrap operation
- Fully operational to +600 V
- Tolerant to negative transient voltage,  $dV/dt$  immune
- Gate drive supply range from 10 V to 20 V
- Undervoltage lockout for both channels
- 3.3 V, 5 V, and 15 V input logic compatible
- Cross-conduction prevention logic
- Matched propagation delay for both channels
- High-side output in phase with IN input
- Logic and power ground +/- 5 V offset
- Internal 500 ns deadtime, and programmable up to 5  $\mu$ s with one external  $R_{DT}$  resistor
- Lower  $di/dt$  gate driver for better noise immunity
- The dual function DT/SD input turns off both channels
- RoHS compliant

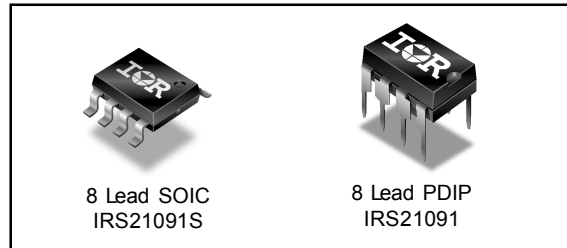
#### Description

The IRS21091 is a high voltage, high speed power MOSFET and IGBT driver with dependent high- and low-side referenced output channels. Proprietary HVIC and latch immune CMOS technologies enable ruggedized monolithic construction. The logic input is compatible with standard CMOS or LSTTL output, down to 3.3 V logic. The output drivers feature a high pulse current buffer stage designed for minimum driver cross-conduction. The floating channel can be used to drive an N-channel power MOSFET or IGBT in the high-side configuration which operates up to 600 V.

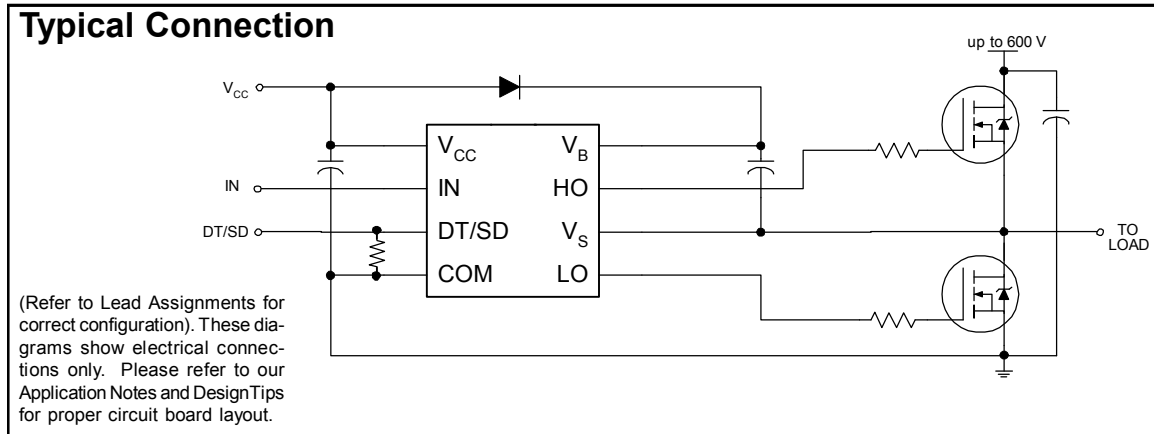
#### Product Summary

$V_{OFFSET}$	600 V max.
$I_{O+/-}$	120 mA / 250 mA
$V_{OUT}$	10 V - 20 V
$t_{on/off}$ (typ.)	750 ns & 200 ns
Deadtime	540 ns

#### Packages



#### Typical Connection



## Absolute Maximum Ratings

Absolute maximum ratings indicate sustained limits beyond which damage to the device may occur. All voltage parameters are absolute voltages referenced to COM. The thermal resistance and power dissipation ratings are measured under board mounted and still air conditions.

Symbol	Definition	Min.	Max.	Units	
$V_B$	High-side floating absolute voltage	-0.3	625	V	
$V_S$	High-side floating supply offset voltage	$V_B - 25$	$V_B + 0.3$		
$V_{HO}$	High-side floating output voltage	$V_S - 0.3$	$V_B + 0.3$		
$V_{CC}$	Low-side and logic fixed supply voltage	-0.3	25		
$V_{LO}$	Low-side output voltage	-0.3	$V_{CC} + 0.3$		
DT/SD	Programmable deadtime and shutdown pin voltage	$V_{SS} - 0.3$	$V_{CC} + 0.3$		
$V_{IN}$	Logic input voltage (IN & DT/SD)	$V_{SS} - 0.3$	$V_{CC} + 0.3$		
$dV_S/dt$	Allowable offset supply voltage transient	—	50	V/ns	
$P_D$	Package power dissipation @ $T_A \leq +25\text{ }^\circ\text{C}$	(8 Lead PDIP)	—	1.0	W
		(8 Lead SOIC)	—	0.625	
$R_{thJA}$	Thermal resistance, junction to ambient	(8 Lead PDIP)	—	125	$^\circ\text{C/W}$
		(8 Lead SOIC)	—	200	
$T_J$	Junction temperature	—	150	$^\circ\text{C}$	
$T_S$	Storage temperature	-50	150		
$T_L$	Lead temperature (soldering, 10 seconds)	—	300		

## Recommended Operating Conditions

The input/output logic timing diagram is shown in Fig.1. For proper operation the device should be used within the recommended conditions. The  $V_S$  offset rating is tested with all supply biased at a 15 V differential.

Symbol	Definition	Min.	Max.	Units
$V_B$	High-side floating supply absolute voltage	$V_S + 10$	$V_S + 20$	V
$V_S$	High-side floating supply offset voltage	(Note 1)	600	
$V_{HO}$	High-side floating output voltage	$V_S$	$V_B$	
$V_{CC}$	Low-side and logic fixed supply voltage	10	20	
$V_{LO}$	Low-side output voltage	0	$V_{CC}$	
$V_{IN}$	Logic input voltage (IN & DT/SD)	$V_{SS}$	$V_{CC}$	
DT/SD	Programmable deadtime and shutdown pin voltage	$V_{SS}$	$V_{CC}$	
$T_A$	Ambient temperature	-40	125	°C

Note 1: Logic operational for  $V_S$  of -5 V to +600 V. Logic state held for  $V_S$  of -5 V to  $-V_{BS}$ . (Please refer to the Design Tip DT97-3 for more details).

## Dynamic Electrical Characteristics

$V_{BIAS} (V_{CC}, V_{BS}) = 15 \text{ V}$ ,  $C_L = 1000 \text{ pF}$ ,  $T_A = 25 \text{ °C}$ , unless otherwise specified.

Symbol	Definition	Min.	Typ.	Max.	Units	Test Conditions
$t_{on}$	Turn-on propagation delay	—	750	950	ns	$V_S = 0 \text{ V}$
$t_{off}$	Turn-off propagation delay	—	200	280		$V_S = 0 \text{ V}$ or $600 \text{ V}$
$t_{sd}$	Shutdown propagation delay	—	550	715		$V_S = 0 \text{ V}$
MT	Delay matching, HS & LS turn-on/off	—	0	70		
$t_r$	Turn-on rise time	—	100	220		
$t_f$	Turn-off fall time	—	35	80		$R_{DT} = 0 \Omega$
DT	Deadtime: LO turn-off to HO turn-on(DT <sub>LO-HO</sub> ) & HO turn-off to LO turn-on (DT <sub>HO-LO</sub> )	400	540	680	$\mu\text{s}$	
		4	5	6	ns	$R_{DT} = 0 \Omega$
MDT	Deadtime matching = DT <sub>LO - HO</sub> - DT <sub>HO-LO</sub>	—	0	60		ns
		—	0	600		

## Static Electrical Characteristics

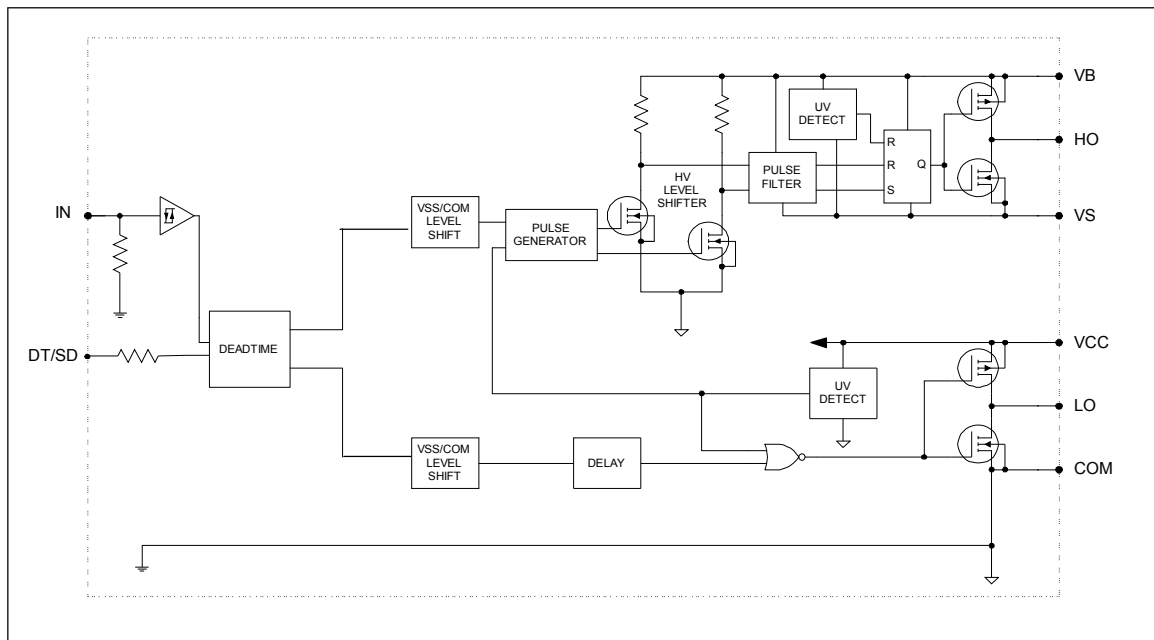
$V_{BIAS}$  ( $V_{CC}$ ,  $V_{BS}$ ) = 15 V, and  $T_A$  = 25 °C unless otherwise specified. The  $V_{IL}$ ,  $V_{IH}$ , and  $I_{IN}$  parameters are referenced to COM and are applicable to the respective input leads: IN and DT/SD. The  $V_O$ ,  $I_O$ , and  $R_{ON}$  parameters are referenced to COM and are applicable to the respective output leads: HO and LO.

Symbol	Definition	Min.	Typ.	Max.	Units	Test Conditions
$V_{IH}$	Logic "1" input voltage for HO & logic "0" for LO	2.5	—	—	V	$V_{CC} = 10\text{ V to }20\text{ V}$
$V_{IL}$	Logic "0" input voltage for HO & logic "1" for LO	—	—	0.8		
$V_{SD,TH}$	DT/SD input threshold	11.5	13	14.5		
$V_{OH}$	High level output voltage, $V_{BIAS} - V_O$	—	0.05	0.2		
$V_{OL}$	Low level output voltage, $V_O$	—	0.02	0.1		
$I_{LK}$	Offset supply leakage current	—	—	50	$\mu\text{A}$	$V_B = V_S = 600\text{ V}$
$I_{QBS}$	Quiescent $V_{BS}$ supply current	20	75	130		$I_N = 0\text{ V or }5\text{ V}$
$I_{QCC}$	Quiescent $V_{CC}$ supply current	0.4	1.0	1.6	$\text{mA}$	$I_N = 0\text{ V or }5\text{ V}$ $R_{DT} = 0\ \Omega$
$I_{IN+}$	Logic "1" input bias current	—	5	20	$\mu\text{A}$	$I_N = 5\text{ V, DT/SD} = 0\text{ V}$
$I_{IN-}$	Logic "0" input bias current	—	—	5		$I_N = 0\text{ V, DT/SD} = 5\text{ V}$
$V_{CCUV+}$ $V_{BSUV+}$	$V_{CC}$ and $V_{BS}$ supply undervoltage positive going threshold	8.0	8.9	9.8	V	
$V_{CCUV-}$ $V_{BSUV-}$	$V_{CC}$ and $V_{BS}$ supply undervoltage negative going threshold	7.4	8.2	9.0		
$V_{CCUVH}$ $V_{BSUVH}$	Hysteresis	0.3	0.7	—		
$I_{O+}$	Output high short circuit pulsed current	120	290	—	$\text{mA}$	$V_O = 0\text{ V, PW} \leq 10\ \mu\text{s}$
$I_{O-}$	Output low short circuit pulsed current	250	600	—		$V_O = 15\text{ V, PW} \leq 10\ \mu\text{s}$

## Lead Assignments

<p>8 Lead PDIP</p>	<p>8 Lead SOIC</p>
<b>IRS21091PbF</b>	<b>IRS21091SPbF</b>

## Functional Block Diagrams



## Lead Definitions

Symbol	Description
IN	Logic input for high-side and low-side gate driver outputs (HO and LO), in phase with HO
DT/SD	Programmable deadtime lead, disables input/output logic when tied to V <sub>CC</sub>
V <sub>B</sub>	High-side floating supply
HO	High-side gate drive output
V <sub>S</sub>	High-side floating supply return
V <sub>CC</sub>	Low-side and logic fixed supply
LO	Low-side gate drive output
COM	Low-side return

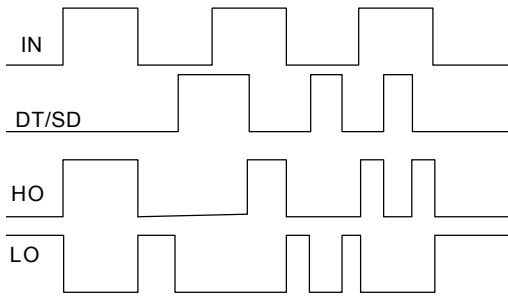


Figure 1. Input/Output Timing Diagram

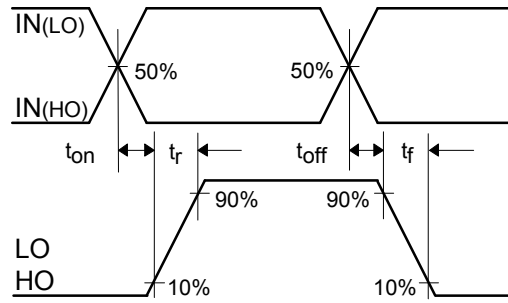


Figure 2. Switching Time Waveform Definitions

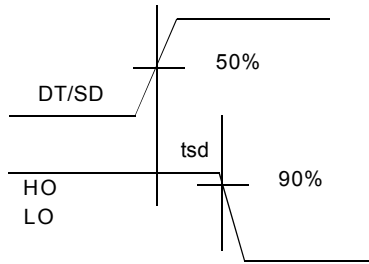


Figure 3. Shutdown Waveform Definitions

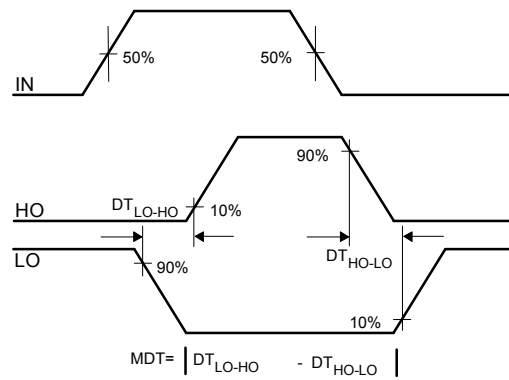


Figure 4. Deadtime Waveform Definitions

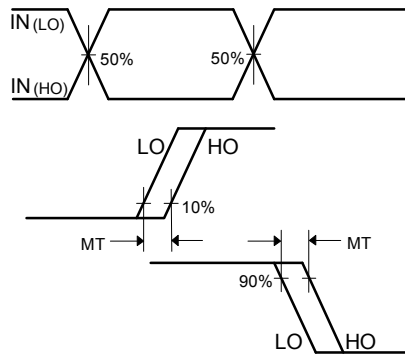
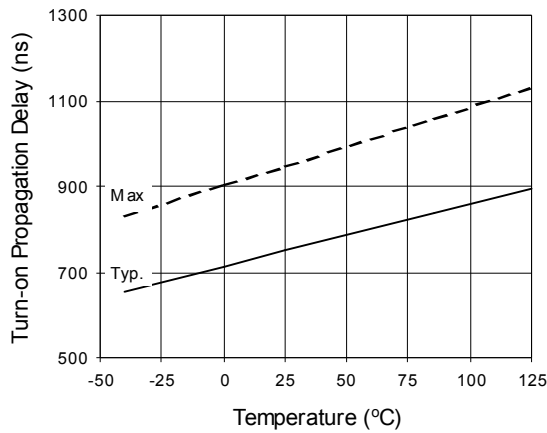
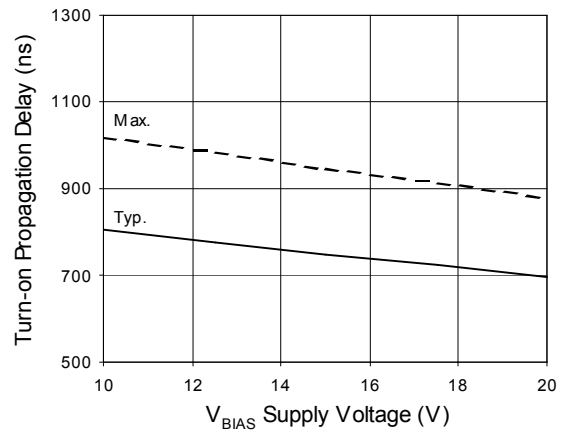


Figure 5. Delay Matching Waveform Definitions

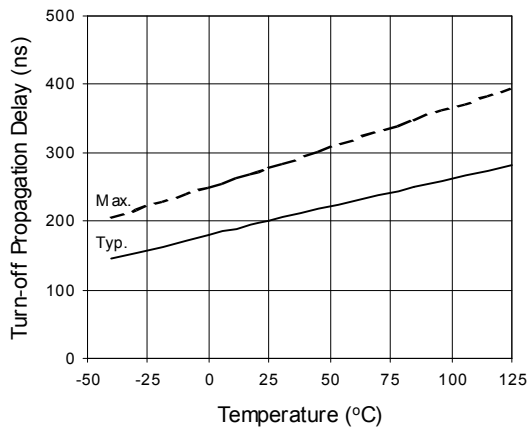
**Note:** For the following figures the  $V_{BIAS}$  ( $V_{CC}$ ,  $V_{BS}$ ) = 15 V and  $T_A = 25^\circ\text{C}$  unless otherwise specified.



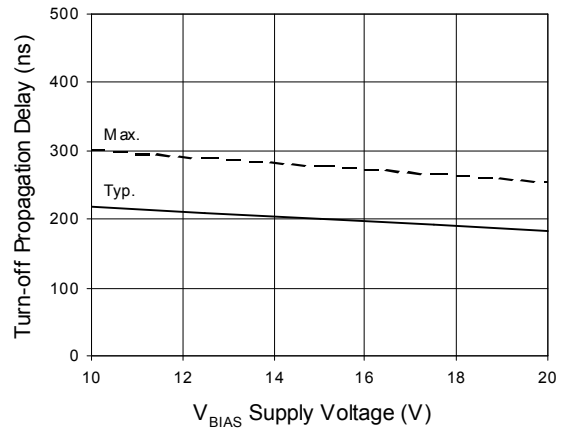
**Figure 6A. Turn-On Propagation Delay vs. Temperature**



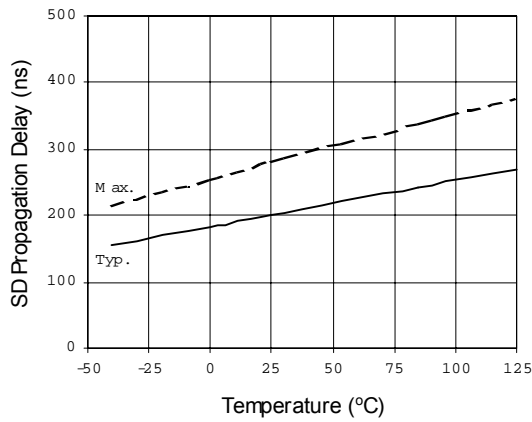
**Figure 6B. Turn-On Propagation Delay vs. Supply Voltage**



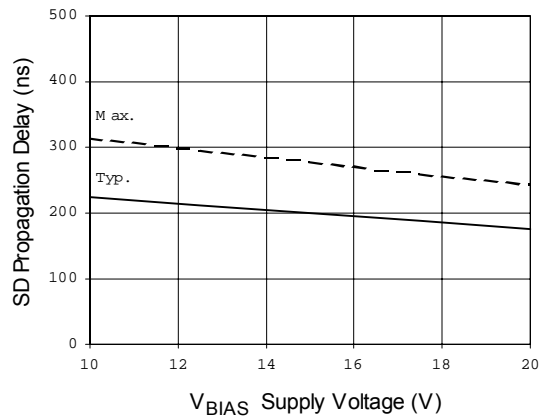
**Figure 7A. Turn-Off Propagation Delay vs. Temperature**



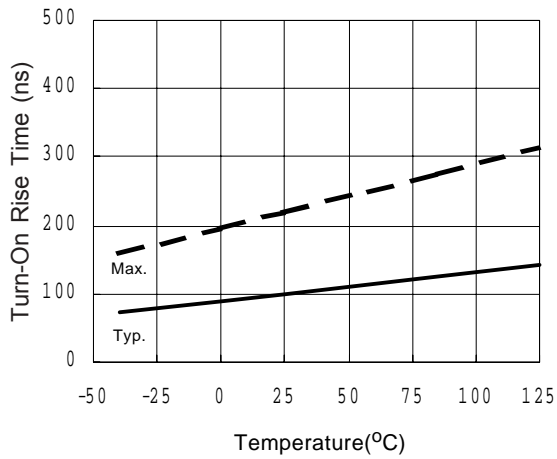
**Figure 7B. Turn-Off Propagation Delay vs. Supply Voltage**



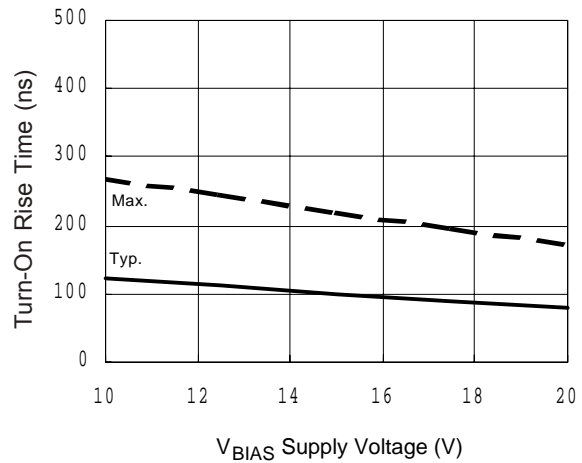
**Figure 8A. SD Propagation Delay vs. Temperature**



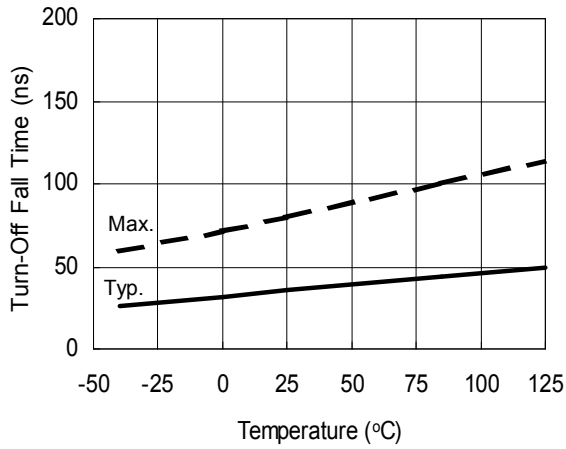
**Figure 8B. SD Propagation Delay vs. Supply Voltage**



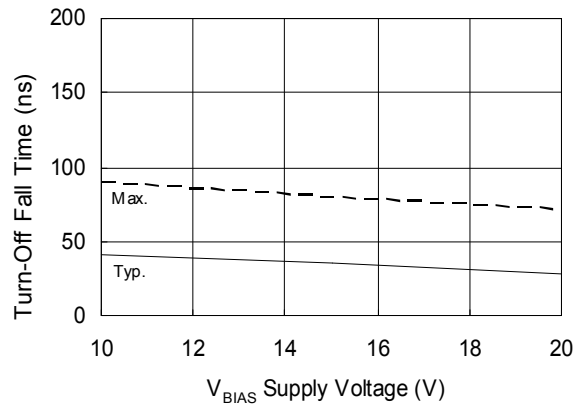
**Figure 9A. Turn-On Rise Time vs. Temperature**



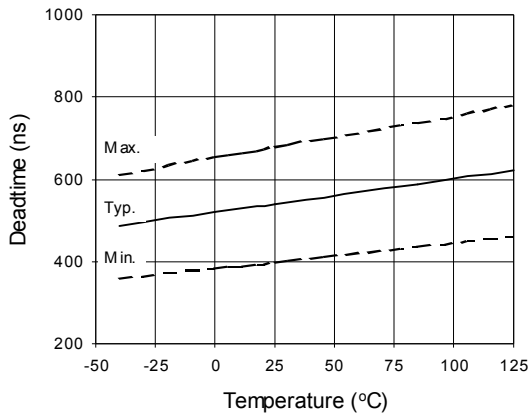
**Figure 9B. Turn-On Rise Time vs. Supply Voltage**



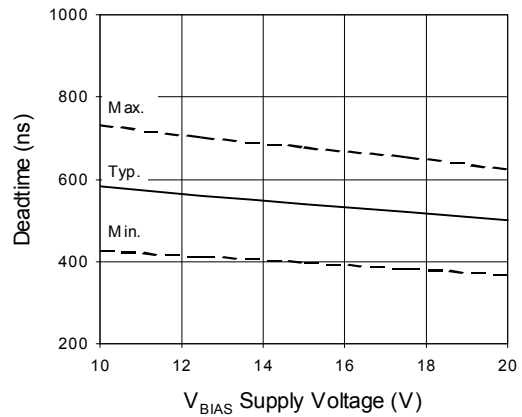
**Figure 10A. Turn-Off Fall Time vs. Temperature**



**Figure 10B. Turn-Off Fall Time vs. Supply Voltage**



**Figure 11A. Deadtime vs. Temperature**



**Figure 11B. Deadtime vs. Supply Voltage**

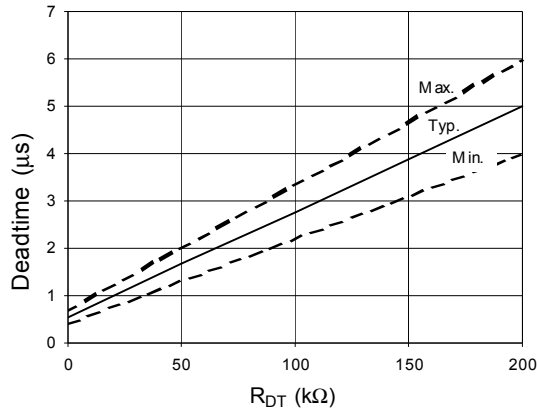


Figure 11C. Deadtime vs. R<sub>DT</sub>

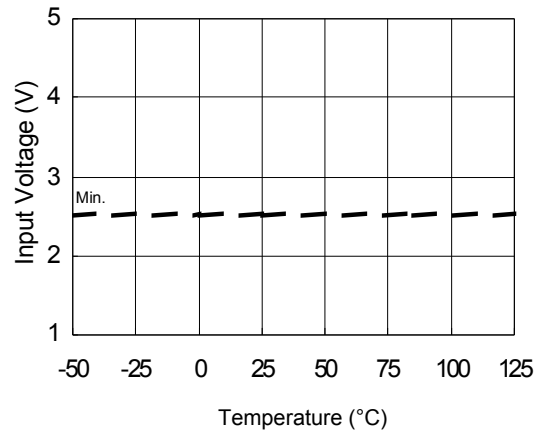


Figure 12A. Logic "1" Input Voltage vs. Temperature

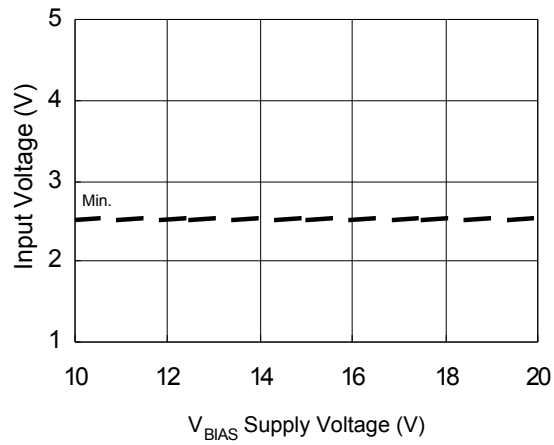


Figure 12B. Logic "1" Input Voltage vs. Supply Voltage

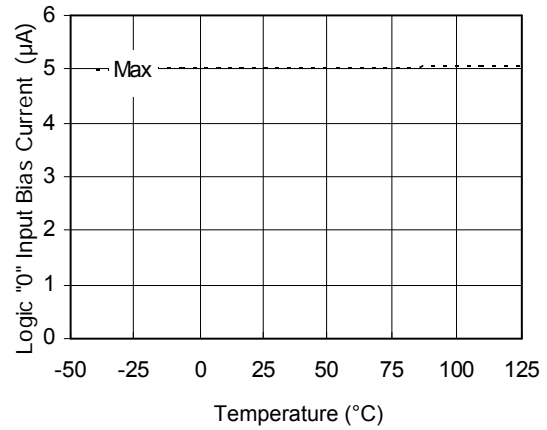
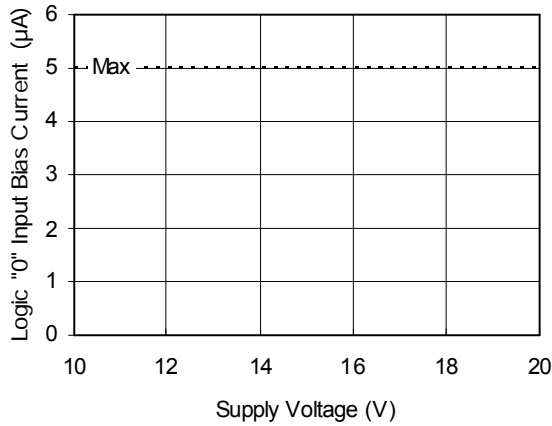
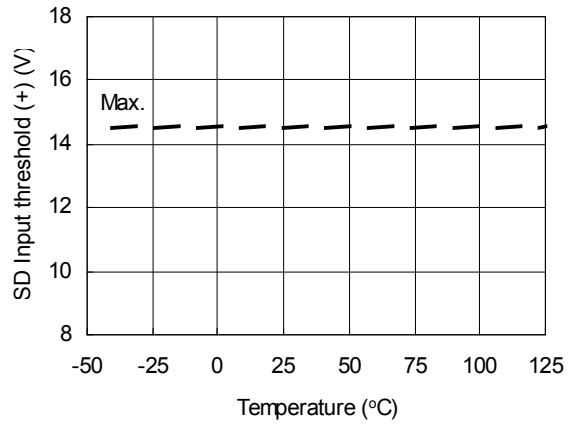


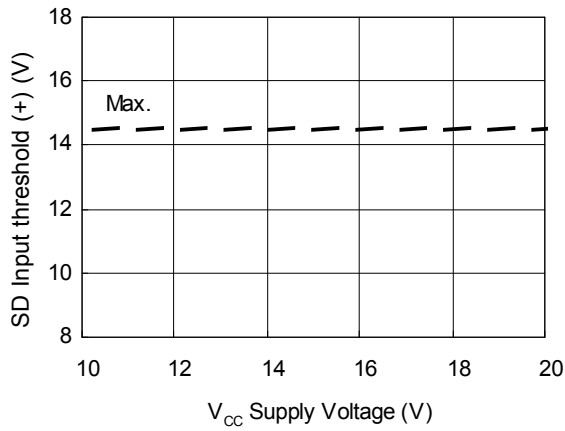
Figure 13A. Logic "0" Input Bias Current vs. Temperature



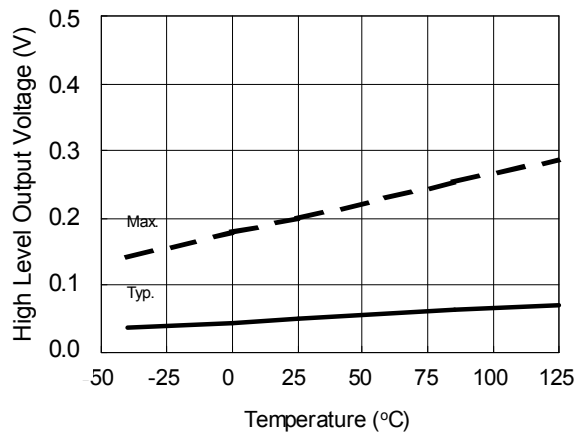
**Figure 13B. Logic "0" Input Bias Current vs. Voltage**



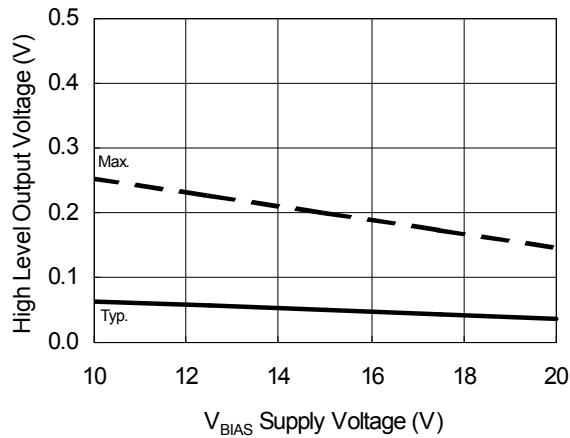
**Figure 14A. SD Input Positive Going Threshold (+) vs. Temperature**



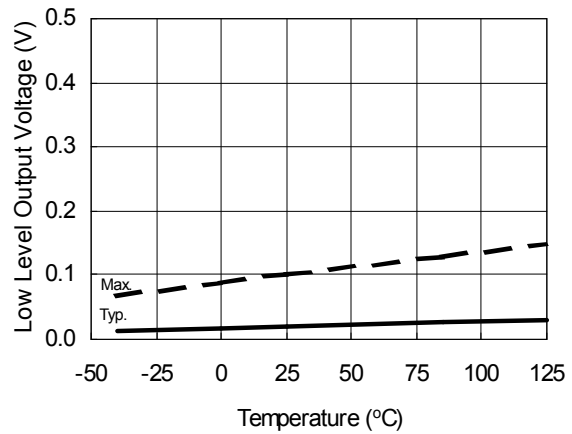
**Figure 14B. SD Input Positive Going Threshold (+) vs. Supply Voltage**



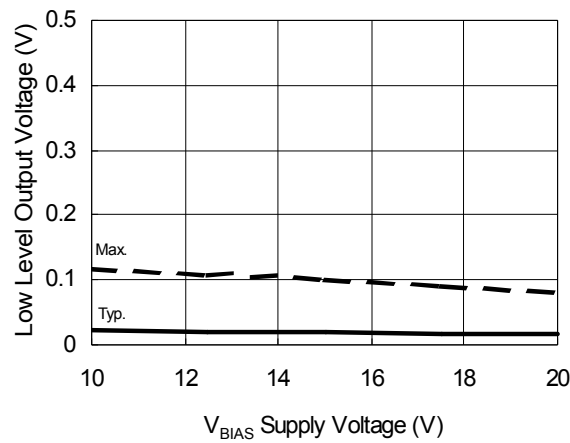
**Figure 15A. High Level Output Voltage vs. Temperature**



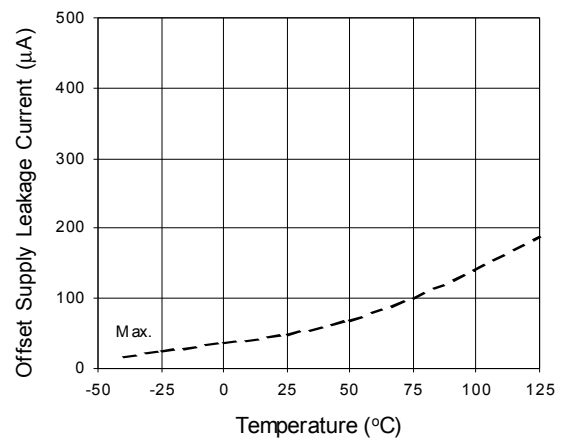
**Figure 15B. High Level Output Voltage vs. Supply Voltage**



**Figure 16A. Low Level Output Voltage vs. Temperature**



**Figure 16B. Low Level Output Voltage vs. Supply Voltage**



**Figure 17A. Offset Supply Leakage Current vs. Temperature**

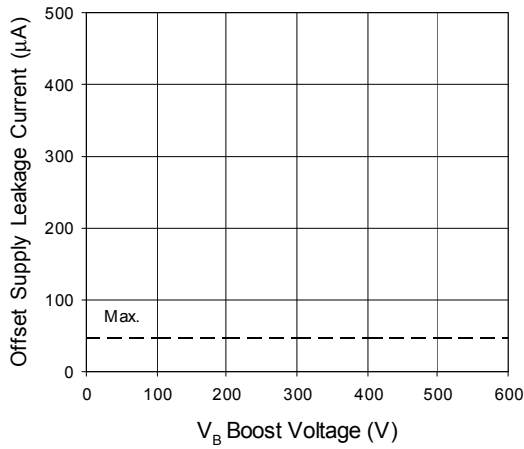


Figure 17B. Offset Supply Leakage Current vs. Boost Voltage

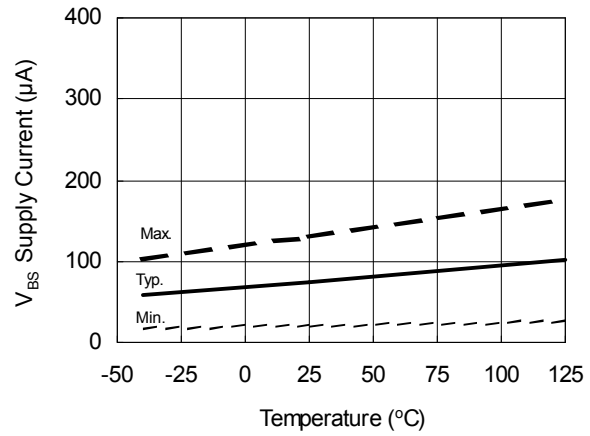


Figure 18A. V<sub>BS</sub> Supply Current vs. Temperature

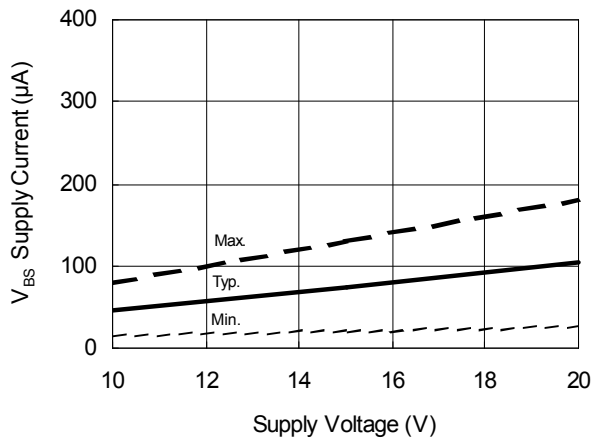


Figure 18B. V<sub>BS</sub> Supply Current vs. Supply Voltage

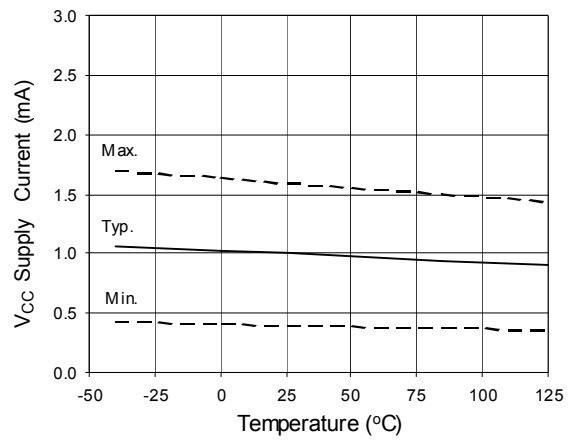
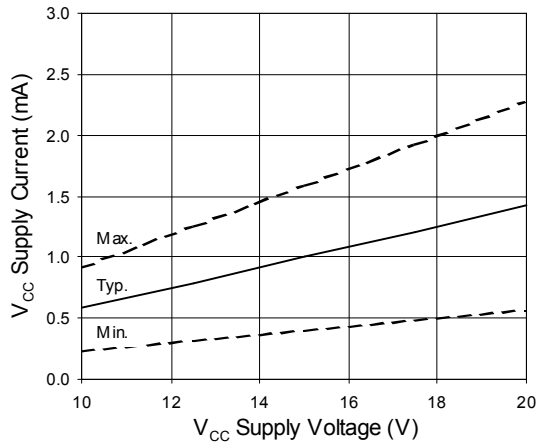
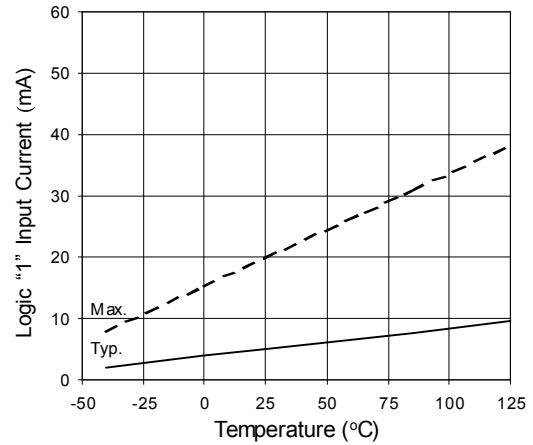


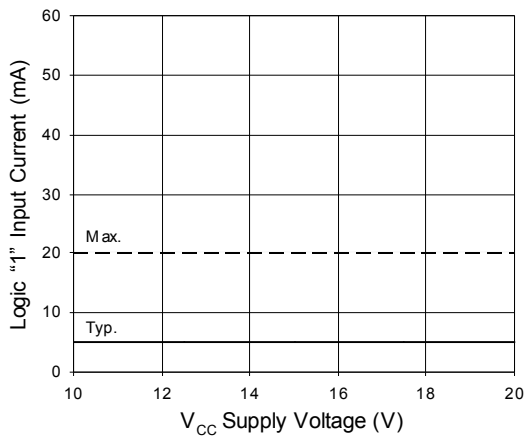
Figure 19A. V<sub>CC</sub> Supply Current vs. Temperature



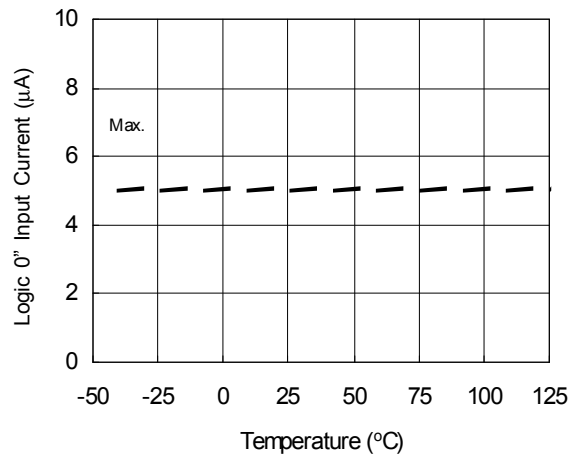
**Figure 19B. V<sub>CC</sub> Supply Current vs. V<sub>CC</sub> Supply Voltage**



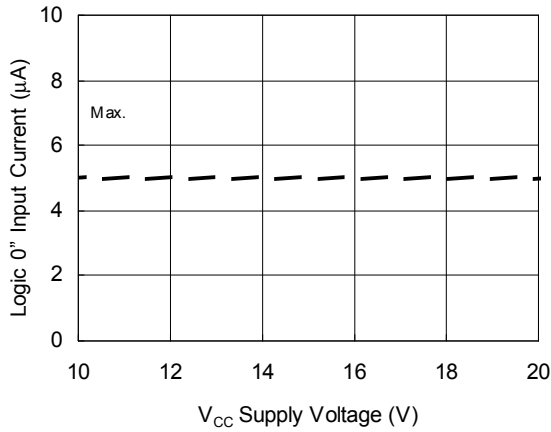
**Figure 20A. Logic "1" Input Current vs. Temperature**



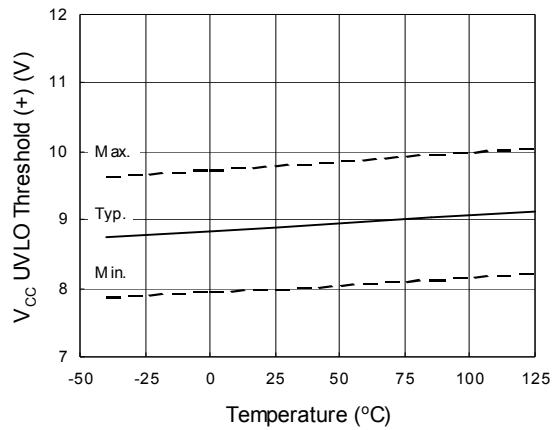
**Figure 20B. Logic "1" Input Current vs. Supply Voltage**



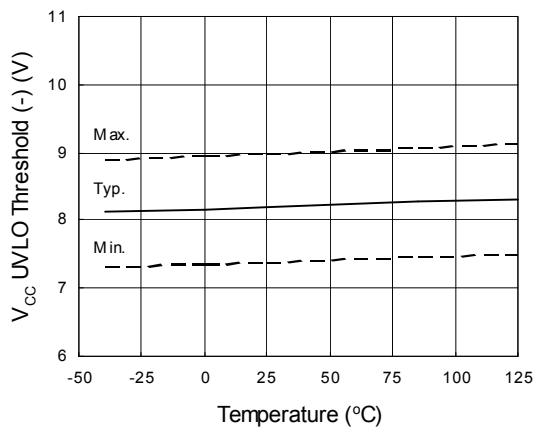
**Figure 21A. Logic "0" Input Current vs. Temperature**



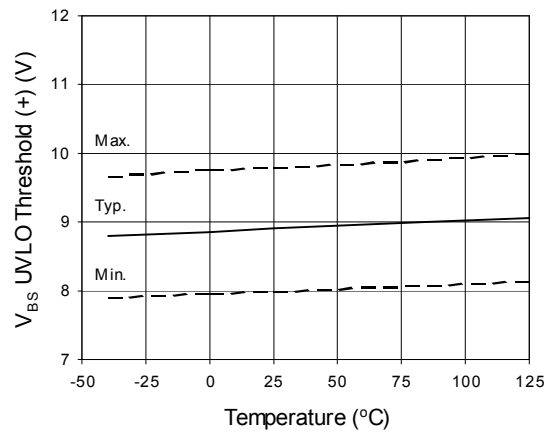
**Figure 21B. Logic "0" Input Current vs. Supply Voltage**



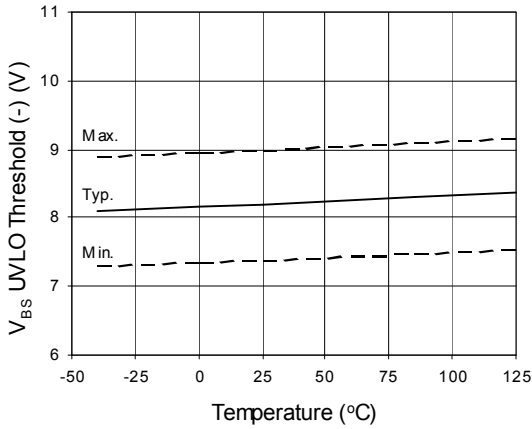
**Figure 22. V<sub>CC</sub> Undervoltage Threshold (+) vs. Temperature**



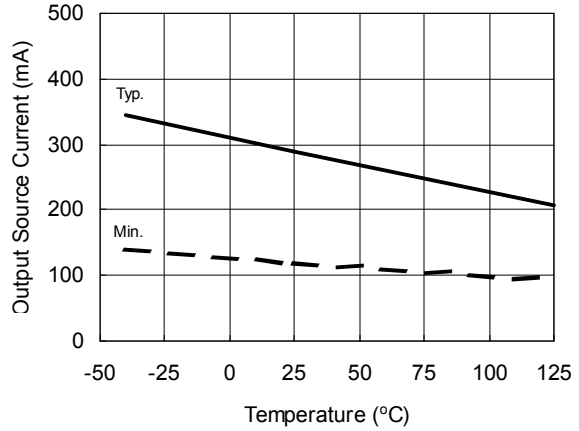
**Figure 23. V<sub>CC</sub> Undervoltage Threshold (-) vs. Temperature**



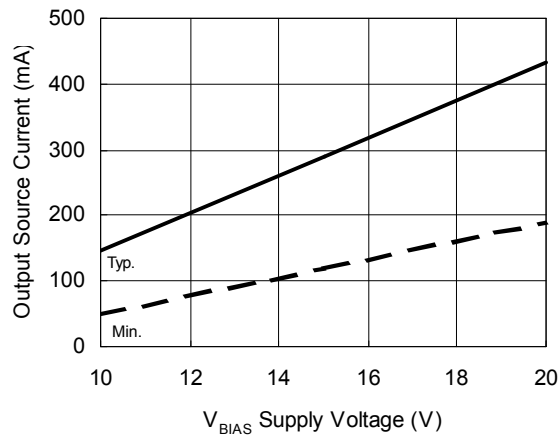
**Figure 24. V<sub>BS</sub> Undervoltage Threshold (+) vs. Temperature**



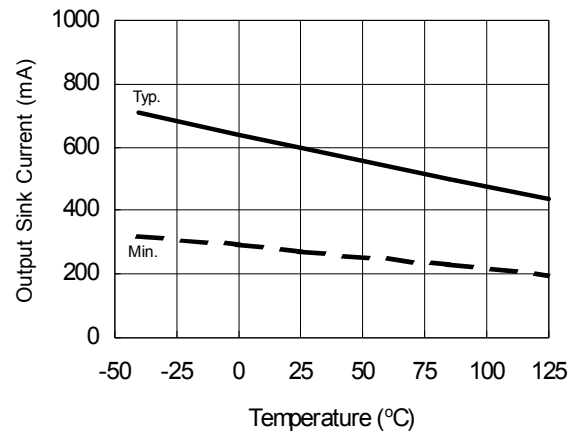
**Figure 25. V<sub>BS</sub> Undervoltage Threshold (-) vs. Temperature**



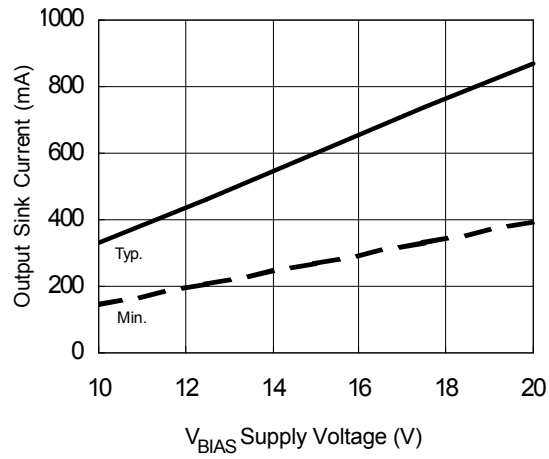
**Figure 26A. Output Source Current vs. Temperature**



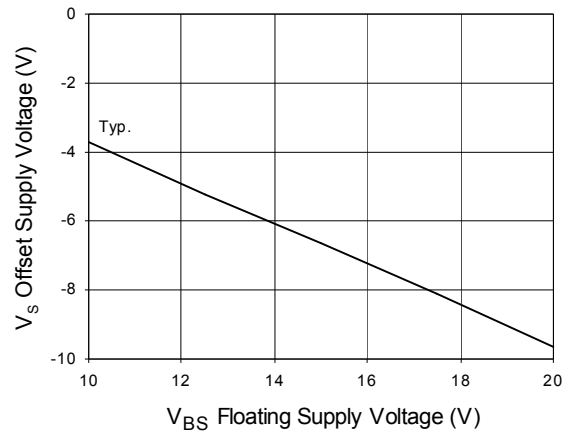
**Figure 26B. Output Source Current vs. Supply Voltage**



**Figure 27A. Output Sink Current vs. Temperature**

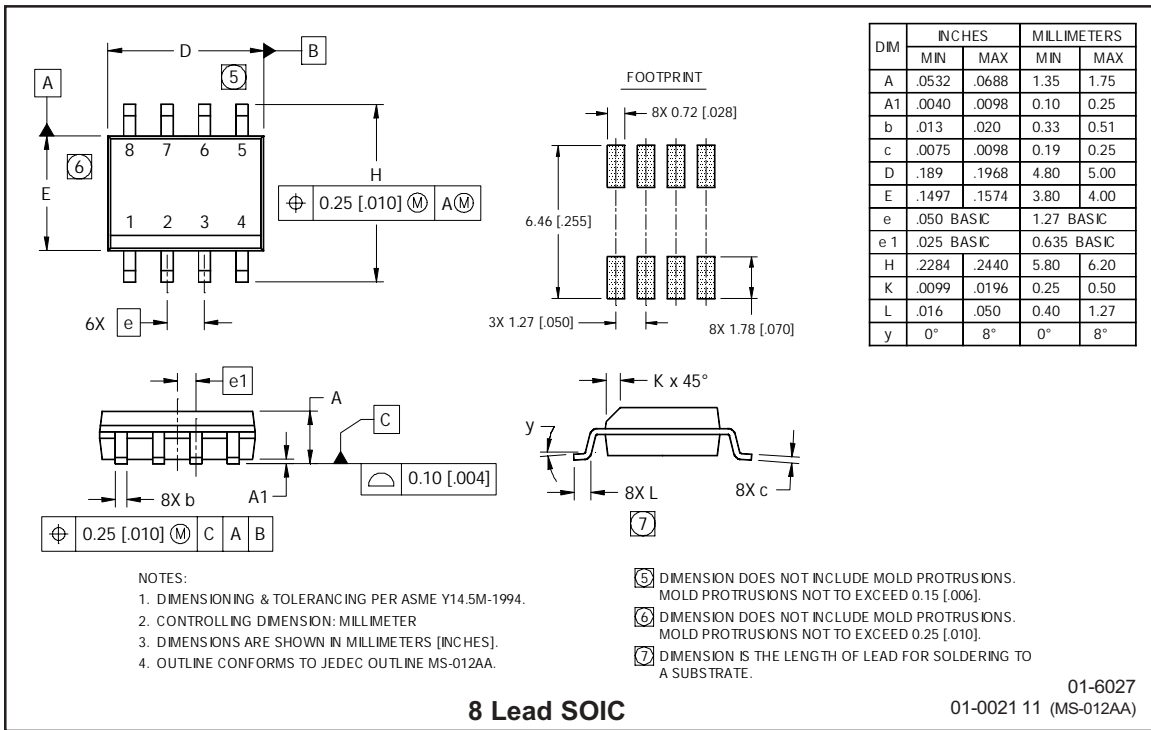
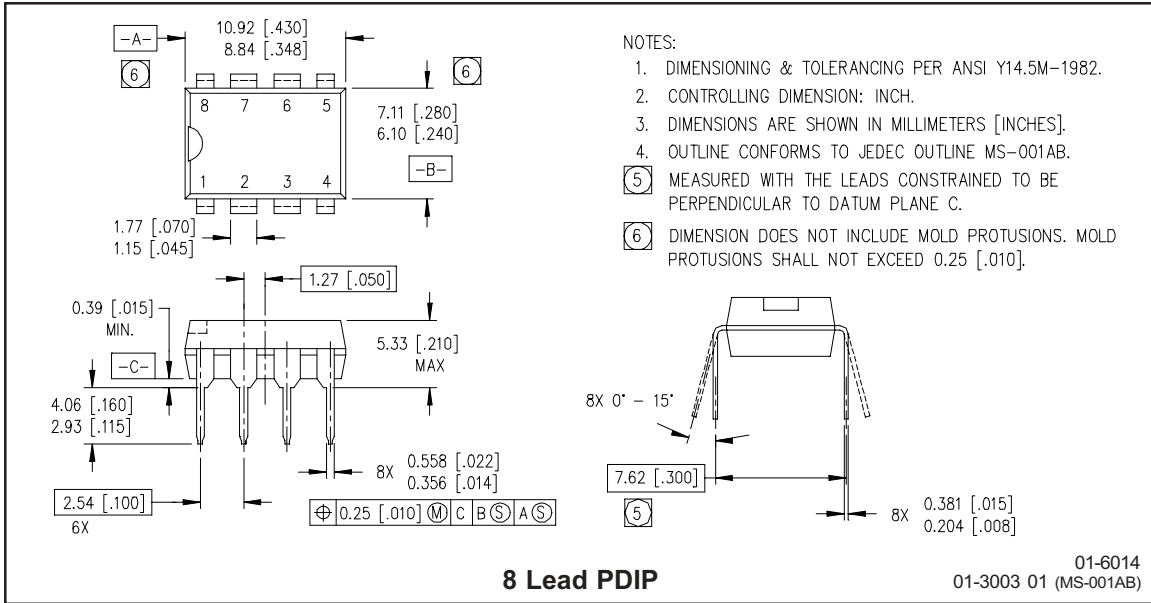


**Figure 27B. Output Sink Current vs. Supply Voltage**

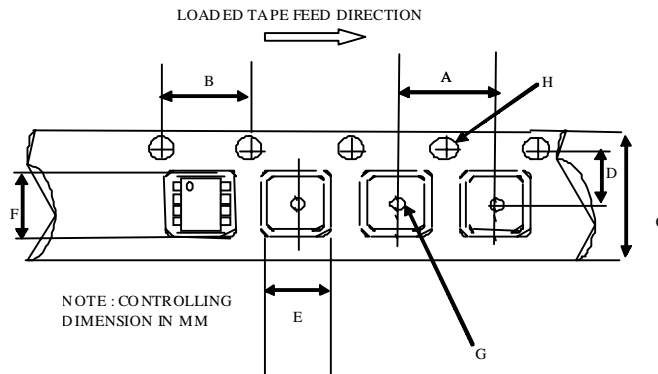


**Figure 28. Maximum  $V_s$  Negative Offset vs. Supply Voltage**

## Case Outlines

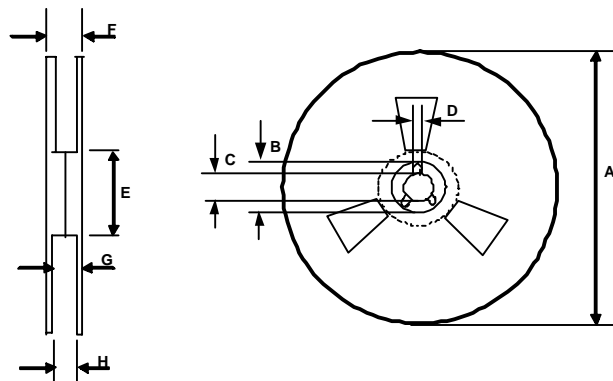


## Tape & Reel 8-lead SOIC



CARRIER TAPE DIMENSION FOR 8SOICN

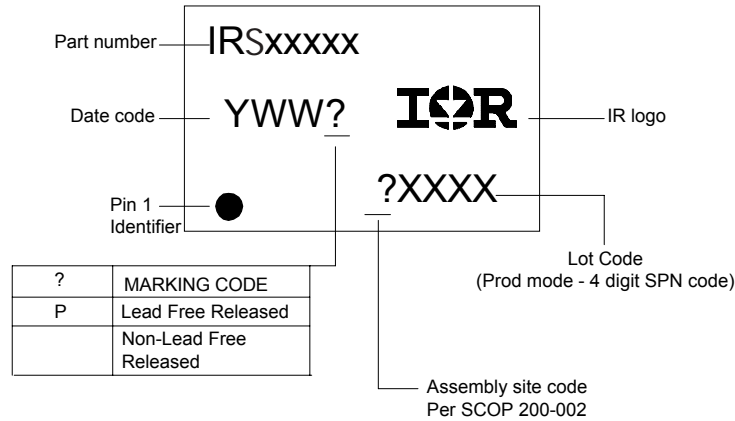
Code	Metric		Imperial	
	Min	Max	Min	Max
A	7.90	8.10	0.311	0.318
B	3.90	4.10	0.153	0.161
C	11.70	12.30	0.46	0.484
D	5.45	5.55	0.214	0.218
E	6.30	6.50	0.248	0.255
F	5.10	5.30	0.200	0.208
G	1.50	n/a	0.059	n/a
H	1.50	1.60	0.059	0.062



REEL DIMENSIONS FOR 8SOICN

Code	Metric		Imperial	
	Min	Max	Min	Max
A	329.60	330.25	12.976	13.001
B	20.95	21.45	0.824	0.844
C	12.80	13.20	0.503	0.519
D	1.95	2.45	0.767	0.096
E	98.00	102.00	3.858	4.015
F	n/a	18.40	n/a	0.724
G	14.50	17.10	0.570	0.673
H	12.40	14.40	0.488	0.566

## LEADFREE PART MARKING INFORMATION



## ORDER INFORMATION

- 8-Lead PDIP IRS21091PbF
- 8-Lead SOIC IRS21091SPbF
- 8-Lead SOIC Tape & Reel IRS21091STRPbF

## Looking for pricing, stock, or lifecycle information?

Click below to explore more details on WIN SOURCE:

 [View IRS21091STRPBF on WIN SOURCE](#)

 [Infineon Technologies](#) Information

## Optimize Your Supply Chain with WIN SOURCE Solutions

-  Global Sourcing Solution
-  Obsolete Management
-  Cost Control Management
-  Shortage Management
-  Alternative Solution
-  Excess Inventory Management