



**THE DATASHEET OF  
AD7503JQ**



## AD7501/AD7502/AD7503

### FEATURES

- DTL/TTL/CMOS Direct Interface
- Power Dissipation: 30  $\mu$ W
- $R_{ON}$ : 170  $\Omega$
- Standard 16-Lead DIPs and 20-Terminal Surface Mount Packages

### GENERAL DESCRIPTION

The AD7501 and AD7503 are monolithic CMOS, 8-channel analog multiplexers which switch one of eight inputs to a common output, depending on the state of three binary address lines and an "enable" input. The AD7503 is identical to the AD7501 except its "enable" logic is inverted. All digital inputs are TTL/DTL and CMOS logic compatible.

The AD7502 is a monolithic CMOS dual 4-channel analog multiplexer. Depending on the state of two binary address inputs and an "enable," it switches two output buses to two of eight inputs.

### Truth Tables

AD7501

$A_2$	$A_1$	$A_0$	EN	"ON"
0	0	0	1	1
0	0	1	1	2
0	1	0	1	3
0	1	1	1	4
1	0	0	1	5
1	0	1	1	6
1	1	0	1	7
1	1	1	1	8
X	X	X	0	None

AD7503

$A_2$	$A_1$	$A_0$	EN	"ON"
0	0	0	0	1
0	0	1	0	2
0	1	0	0	3
0	1	1	0	4
1	0	0	0	5
1	0	1	0	6
1	1	0	0	7
1	1	1	0	8
X	X	X	1	None

FUNCTIONAL BLOCK DIAGRAM  
AD7501/AD7503

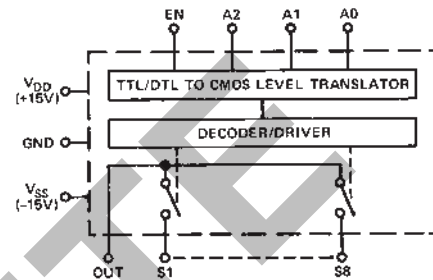

AD7502

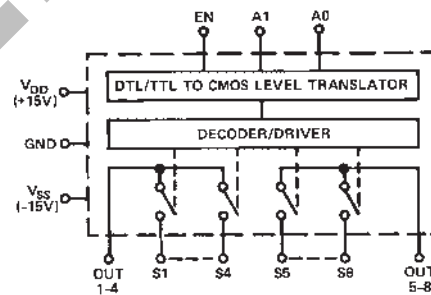

AD7502

$A_1$	$A_0$	EN	"ON"
0	0	1	1 & 5
0	1	1	2 & 6
1	0	1	3 & 7
1	1	1	4 & 8
X	X	0	None

### REV. B

Information furnished by Analog Devices is believed to be accurate and reliable. However, no responsibility is assumed by Analog Devices for its use, nor for any infringements of patents or other rights of third parties that may result from its use. No license is granted by implication or otherwise under any patent or patent rights of Analog Devices. Trademarks and registered trademarks are the property of their respective companies.

# AD7501/AD7502/AD7503—SPECIFICATIONS ( $V_{DD} = +15\text{ V}$ , $V_{SS} = -15\text{ V}$ unless otherwise noted.)

Parameter	Version <sup>1</sup>	Switch Condition	@ +25°C		Over Specified Temperature Range		Test Conditions
			AD7501, AD7503	AD7502	AD7501, AD7503	AD7502	
<b>ANALOG SWITCH</b>							
$R_{ON}$	All	ON	170 $\Omega$ typ, 300 $\Omega$ max	170 $\Omega$ typ, 300 $\Omega$ max			$-10\text{ V} \leq V_S \leq +10\text{ V}$ $I_S = 1.0\text{ mA}$ $V_S = 0\text{ V}$ , $I_S = 1.0\text{ mA}$
$R_{ON}$ vs. $V_S$	All	ON	20% typ	20% typ			
$R_{ON}$ vs. Temperature	All	ON	0.5%/°C typ	0.5%/°C typ			
$\Delta R_{ON}$ Between Switches	All	ON	4% typ	4% typ			
$R_{ON}$ vs. Temperature Between Switches	All	ON	$\pm 0.01\%/^{\circ}\text{C}$	$\pm 0.01\%/^{\circ}\text{C}$			$V_S = -10\text{ V}$ , $V_{OUT} = +10\text{ V}$ and $V_S = +10\text{ V}$ , $V_{OUT} = -10\text{ V}$ $V_S = -10\text{ V}$ , $V_{OUT} = +10\text{ V}$ and $V_S = +10\text{ V}$ , $V_{OUT} = -10\text{ V}$ AD7501/02: Enable LOW AD7503: Enable HIGH $V_S = 0$
$I_S$	K	OFF	0.2 nA typ, 2 nA max	0.2 nA typ, 2 nA max	50 nA max	50 nA max	
$I_{OUT}$	S	OFF	0.5 nA max	0.5 nA max	50 nA max	50 nA max	
	K	OFF	1 nA typ, 10 nA max	0.6 nA typ, 5 nA max	250 nA max	125 nA max	
$ I_{OUT} - I_S $	S	OFF	5 nA max	3 nA max	250 nA max	125 nA max	
	K	ON	12 nA max	7 nA max	300 nA max	175 nA max	
	S	ON	5.5 nA max	3.5 nA max	300 nA max	175 nA max	
	<b>DIGITAL CONTROL</b>						
$V_{INL}$	All				0.8 V max	0.8 V max	
$V_{INH}$	All				2.4 V min	2.4 V min	
$I_{INL}$ or $I_{INH}$	All		10 nA typ	10 nA typ			
$C_{IN}$	All		3 pF typ	3 pF typ			
<b>DYNAMIC CHARACTERISTICS</b>							
$t_{ON}$	All		0.8 $\mu\text{s}$ typ	0.8 $\mu\text{s}$ typ			$V_{IN} = 0$ to $+5.0\text{ V}$ (See Test Circuit 2)
$t_{OFF}$	All		0.8 $\mu\text{s}$ typ	0.8 $\mu\text{s}$ typ			
$C_S$	All	OFF	5 pF typ	5 pF typ			
$C_{OUT}$	All	OFF	30 pF typ	15 pF typ			
$C_{SOUT}$	All	OFF	0.5 pF typ	0.5 pF typ			
$C_{SS}$ Between Any Two Switches	All	OFF	0.5 pF typ	0.5 pF typ			
<b>POWER SUPPLY</b>							
$I_{DD}$	All		500 $\mu\text{A}$ max	500 $\mu\text{A}$ max	500 $\mu\text{A}$ max	500 $\mu\text{A}$ max	All Digital Inputs Low
$I_{SS}$	All		500 $\mu\text{A}$ max	500 $\mu\text{A}$ max	500 $\mu\text{A}$ max	500 $\mu\text{A}$ max	All Digital Inputs High
$I_{DD}$	All		800 $\mu\text{A}$ max	800 $\mu\text{A}$ max	800 $\mu\text{A}$ max	800 $\mu\text{A}$ max	
$I_{SS}$	All		800 $\mu\text{A}$ max	800 $\mu\text{A}$ max	800 $\mu\text{A}$ max	800 $\mu\text{A}$ max	

## NOTES

<sup>1</sup>KN version specified for 0°C to +70°C, KQ version for -25°C to +85°C; and SQ, SE versions for -55°C to +125°C.

Specifications subject to change without notice.

## ABSOLUTE MAXIMUM RATINGS

( $T_A = +25^{\circ}\text{C}$  unless otherwise noted)

$V_{DD}$  to GND . . . . . +17 V

$V_{SS}$  to GND . . . . . -17 V

V Between Any Switch Terminals<sup>1</sup> . . . . . 25 V

Digital Input Voltage Range . . . . .  $V_{DD}$  to GND

Overvoltage at  $V_{OUT}$  ( $V_S$ ) . . . . .  $V_{SS}$ ,  $V_{DD}$

Switch Current ( $I_S$ , Continuous One Channel) . . . . . 35 mA

Switch Current ( $I_S$ , Surge One Channel)

1 ms Duration, 10% Duty Cycle . . . . . 50 mA

Power Dissipation (Any Package)

Up to +75°C . . . . . 450 mW

Derates above +75°C by . . . . . 6 mW/°C

## Operating Temperature

Commercial (KN Version) . . . . . 0°C to +70°C

Industrial (KQ Version) . . . . . -25°C to +85°C

Extended (SQ, SE Versions) . . . . . -55°C to +125°C

Storage Temperature . . . . . -65°C to +150°C

Lead Temperature (Soldering, 10 sec) . . . . . +300°C

## CAUTION

<sup>1</sup>Do not apply voltages higher than  $V_{DD}$  and  $V_{SS}$  to any other terminal, especially when  $V_{SS} = V_{DD} = 0\text{ V}$  all other pins should be at 0 V.

<sup>2</sup>The digital control inputs are diode protected; however, permanent damage may occur on unconnected units under high energy electrostatic fields. Keep unused units in conductive foam at all times.

## CAUTION

ESD (electrostatic discharge) sensitive device. Electrostatic charges as high as 4000 V readily accumulate on the human body and test equipment and can discharge without detection. Although the AD7501, AD7502, and AD7503 feature proprietary ESD protection circuitry, permanent damage may occur on devices subjected to high energy electrostatic discharges. Therefore, proper ESD precautions are recommended to avoid performance degradation or loss of functionality.



# AD7501/AD7502/AD7503

## ORDERING GUIDE

Model <sup>1</sup>	Temperature Range	Package Options <sup>2</sup>
AD7501KN	0°C to +70°C	N-16
AD7501KQ	-25°C to +85°C	Q-16
AD7501SQ	-55°C to +125°C	Q-16
AD7501SE	-55°C to +125°C	E-20A
AD7502KN	0°C to +70°C	N-16
AD7502KQ	-25°C to +85°C	Q-16
AD7502SQ	-55°C to +125°C	Q-16
AD7502SE	-55°C to +125°C	E-20A
AD7503KN	0°C to +70°C	N-16
AD7503KQ	-25°C to +85°C	Q-16
AD7503SQ	-55°C to +125°C	Q-16
AD7503SE	-55°C to +125°C	E-20A

### NOTES

<sup>1</sup>To order MIL-STD-883, Class B processed parts, add/883B to part number.

See the Analog Devices' 1990 Military Databook for military data sheet.

<sup>2</sup>E = LCC; N = PDIP; Q = CERDIP.

## PIN CONFIGURATIONS

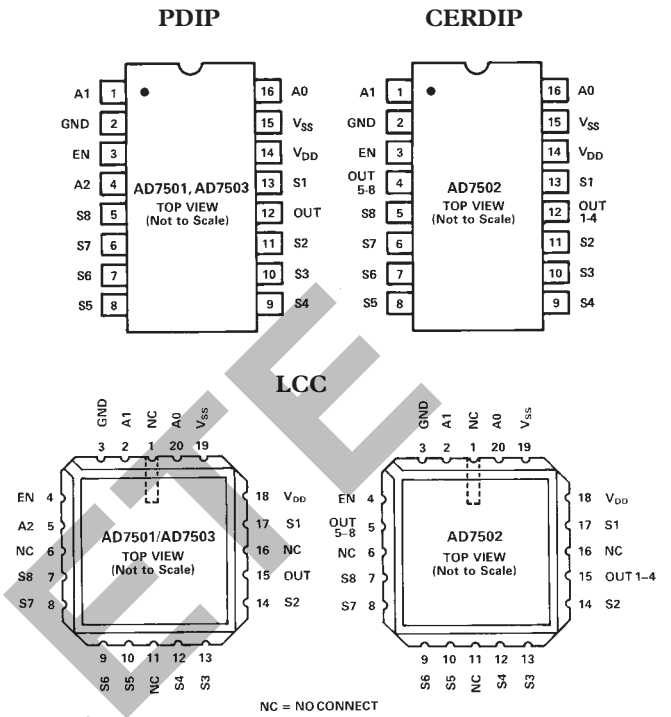

## Typical Performance Characteristics

### 1. R<sub>ON</sub> Versus V<sub>S</sub>

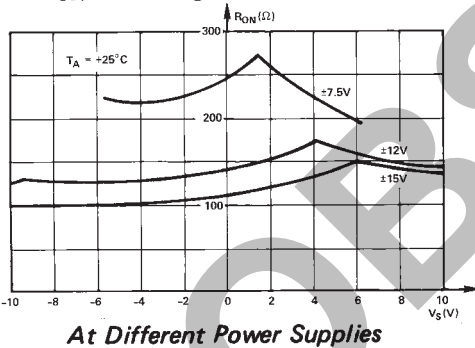

Figure 1a. R<sub>ON</sub> vs. V<sub>S</sub> At Different Power Supplies

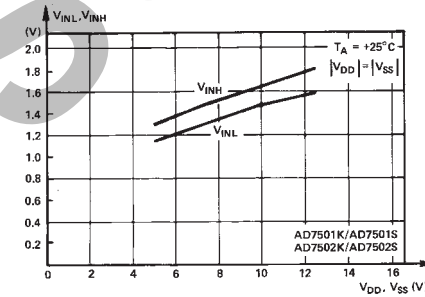

Figure 2a. Digital Threshold Voltage (V<sub>INH</sub>, V<sub>INL</sub>) vs. Power Supply

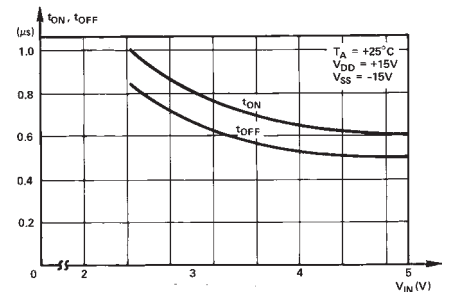

Figure 3. t<sub>ON</sub>, t<sub>OFF</sub> vs. Digital Input Voltage

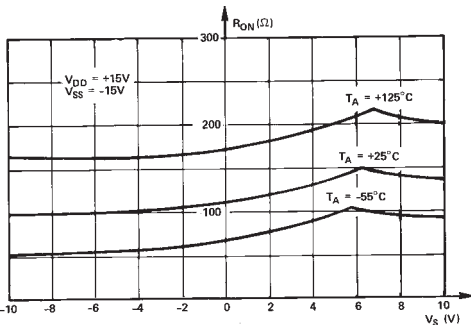

Figure 1b. R<sub>ON</sub> vs. V<sub>S</sub> At Different Temperatures

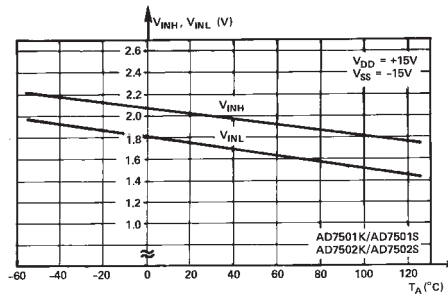

Figure 2b. Digital Threshold Voltage (V<sub>INH</sub>, V<sub>INL</sub>) vs. Temperature

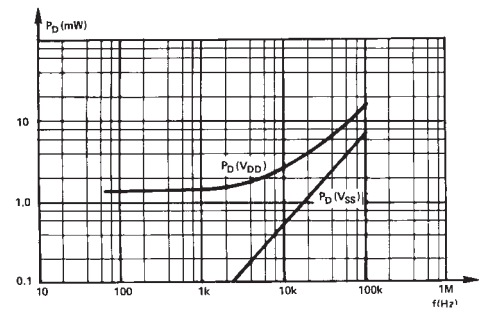
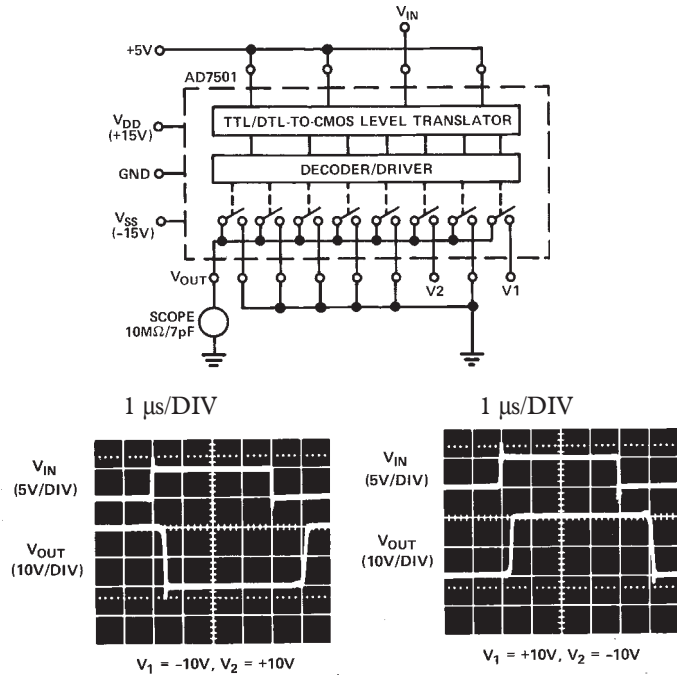

Figure 4. Power Dissipation vs. Logic Frequency (50% Duty Cycle)

# AD7501/AD7502/AD7503

## TYPICAL SWITCHING CHARACTERISTICS

### TEST CIRCUIT 1



### TEST CIRCUIT 2

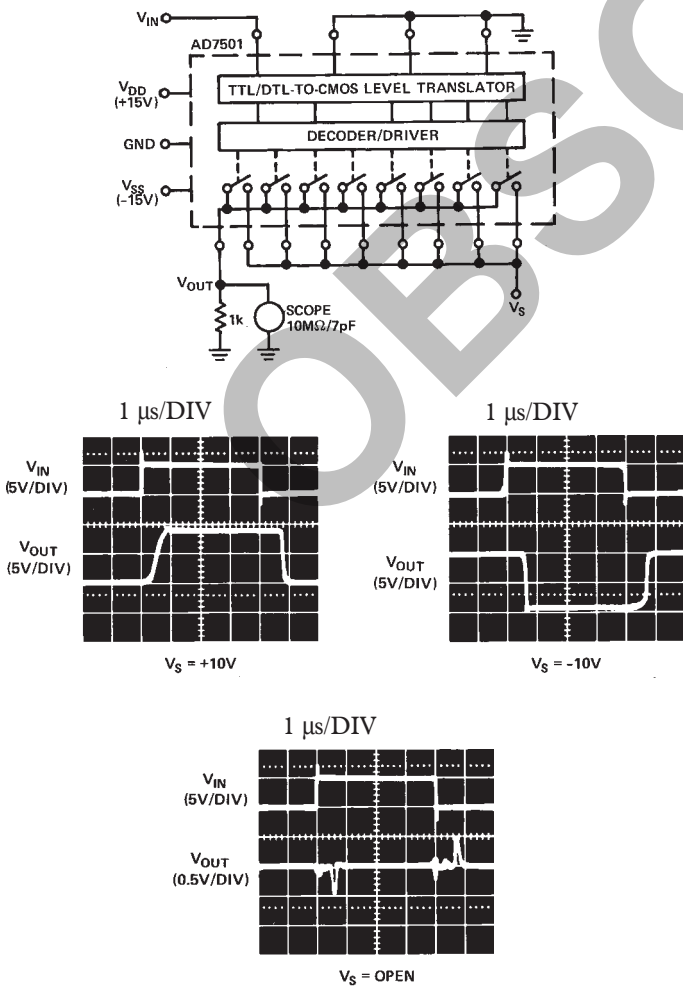

## OUTLINE DIMENSIONS

### 16-Lead Plastic Dual In-Line Package [PDIP] (N-16)

Dimensions shown in inches and (millimeters)

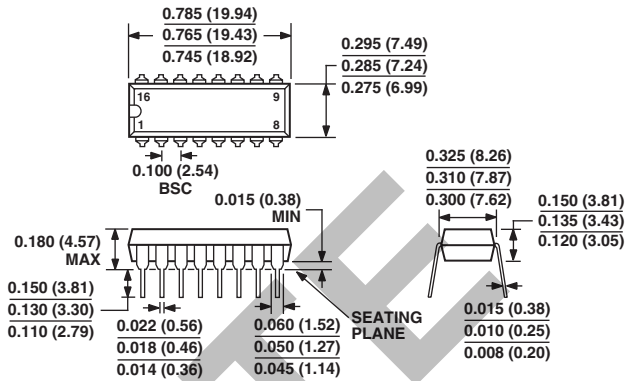

COMPLIANT TO JEDEC STANDARDS MO-095AC  
CONTROLLING DIMENSIONS ARE IN INCHES; MILLIMETER DIMENSIONS (IN PARENTHESES) ARE ROUNDED-OFF INCH EQUIVALENTS FOR REFERENCE ONLY AND ARE NOT APPROPRIATE FOR USE IN DESIGN

### 16-Lead Ceramic Dual In-Line Package [CERDIP] (Q-16)

Dimensions shown in inches and (millimeters)

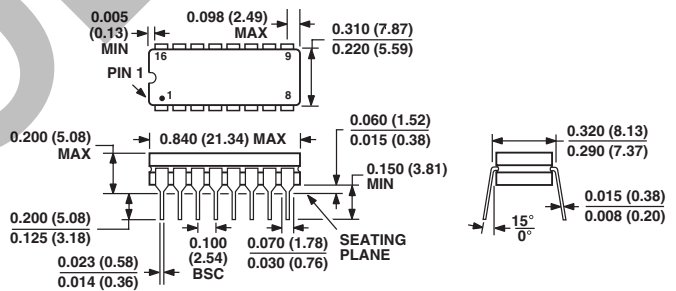

CONTROLLING DIMENSIONS ARE IN INCHES; MILLIMETERS DIMENSIONS (IN PARENTHESES) ARE ROUNDED-OFF INCH EQUIVALENTS FOR REFERENCE ONLY AND ARE NOT APPROPRIATE FOR USE IN DESIGN

### 20-Terminal Ceramic Leadless Chip Carrier [LCC] (E-20A)

Dimensions shown in inches and (millimeters)

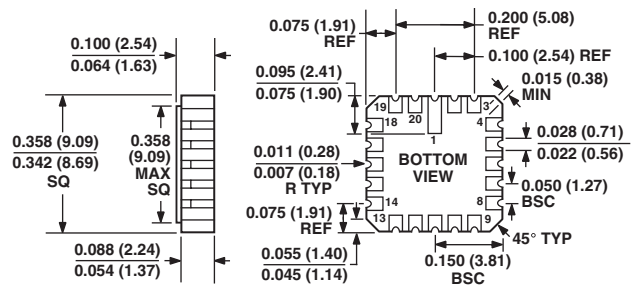

CONTROLLING DIMENSIONS ARE IN INCHES; MILLIMETERS DIMENSIONS (IN PARENTHESES) ARE ROUNDED-OFF INCH EQUIVALENTS FOR REFERENCE ONLY AND ARE NOT APPROPRIATE FOR USE IN DESIGN

## Looking for pricing, stock, or lifecycle information?

Click below to explore more details on WIN SOURCE:

 [View AD7503JQ on WIN SOURCE](#)

 [Analog Devices Inc. Information](#)

## Optimize Your Supply Chain with WIN SOURCE Solutions

-  Global Sourcing Solution
-  Obsolete Management
-  Cost Control Management
-  Shortage Management
-  Alternative Solution
-  Excess Inventory Management