



# THE DATASHEET OF MUR805G



# MUR805G, MUR810G, MUR815G, MUR820G, MUR840G, MUR860G, MURF860G, SUR8820G, SUR8840G



ON Semiconductor®

<http://onsemi.com>

## Switch-mode Power Rectifiers

This series is designed for use in switching power supplies, inverters and as free wheeling diodes.

### Features

- Ultrafast 25 and 50 Nanosecond Recovery Time
- 175°C Operating Junction Temperature
- Epoxy Meets UL 94 V-0 @ 0.125 in
- Low Forward Voltage
- Low Leakage Current
- Reverse Voltage to 600 V
- ESD Ratings:
  - ◆ Machine Model = C (> 400 V)
  - ◆ Human Body Model = 3B (> 16,000 V)
- SUR8 Prefix for Automotive and Other Applications Requiring Unique Site and Control Change Requirements; AEC-Q101 Qualified and PPAP Capable
- These Devices are Pb-Free and are RoHS Compliant\*

### Mechanical Characteristics:

- Case: Epoxy, Molded
- Weight: 1.9 Grams (Approximately)
- Finish: All External Surfaces Corrosion Resistant and Terminal Leads are Readily Solderable
- Lead Temperature for Soldering Purposes: 260°C Max for 10 Seconds

## ULTRAFAST RECTIFIERS 8.0 AMPERES, 50–600 VOLTS

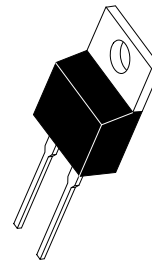
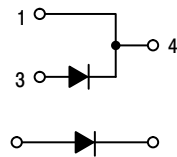

TO-220AC  
CASE 221B  
STYLE 1

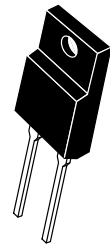

TO-220 FULLPAK  
CASE 221AG  
STYLE 1

### MARKING DIAGRAMS

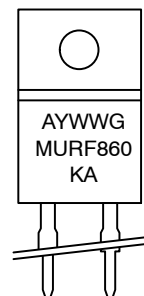
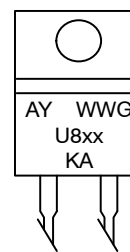

- A = Assembly Location
- Y = Year
- WW = Work Week
- U8XX = Device Code  
xx = 05, 10, 15, 20, 40, or 60
- G = Pb-Free Package
- KA = Diode Polarity

### ORDERING INFORMATION

See detailed ordering and shipping information in the package dimensions section on page 7 of this data sheet.

\*For additional information on our Pb-Free strategy and soldering details, please download the ON Semiconductor Soldering and Mounting Techniques Reference Manual, SOLDERRM/D.

# MUR805G, MUR810G, MUR815G, MUR820G, MUR840G, MUR860G, MURF860G, SUR8820G, SUR8840G

## MAXIMUM RATINGS

Rating	Symbol	MUR/SUR8						Unit
		805	810	815	820	840	860	
Peak Repetitive Reverse Voltage Working Peak Reverse Voltage DC Blocking Voltage	$V_{RRM}$ $V_{RWM}$ $V_R$	50	100	150	200	400	600	V
Average Rectified Forward Current Total Device, (Rated $V_R$ ), $T_C = 150^\circ\text{C}$	$I_{F(AV)}$	8.0						A
Peak Repetitive Forward Current (Rated $V_R$ , Square Wave, 20 kHz), $T_C = 150^\circ\text{C}$	$I_{FM}$	16						A
Nonrepetitive Peak Surge Current (Surge applied at rated load conditions halfwave, single phase, 60 Hz)	$I_{FSM}$	100						A
Operating Junction Temperature and Storage Temperature Range	$T_J, T_{stg}$	-65 to +175						$^\circ\text{C}$

Stresses exceeding those listed in the Maximum Ratings table may damage the device. If any of these limits are exceeded, device functionality should not be assumed, damage may occur and reliability may be affected.

## THERMAL CHARACTERISTICS

Characteristic	Symbol	MUR/SUR8						Unit
		805	810	815	820	840	860	
Maximum Thermal Resistance, Junction-to-Case	$R_{\theta JC}$	3.0			2.0			$^\circ\text{C}/\text{W}$
Thermal Resistance, Junction-to-Case MURF860	$R_{\theta JC}$	4.75						$^\circ\text{C}/\text{W}$
Thermal Resistance, Junction-to-Ambient	$R_{\theta JA}$	73						$^\circ\text{C}/\text{W}$
Thermal Resistance, Junction-to-Ambiente MURF860	$R_{\theta JA}$	75						$^\circ\text{C}/\text{W}$

## ELECTRICAL CHARACTERISTICS

Characteristic	Symbol	MUR/SUR8						Unit
		805	810	815	820	840	860	
Maximum Instantaneous Forward Voltage (Note 1) ( $i_F = 8.0\text{ A}$ , $T_C = 150^\circ\text{C}$ ) ( $i_F = 8.0\text{ A}$ , $T_C = 25^\circ\text{C}$ )	$V_F$	0.895 0.975			1.00 1.30		1.20 1.50	V
Maximum Instantaneous Reverse Current (Note 1) (Rated DC Voltage, $T_J = 150^\circ\text{C}$ ) (Rated DC Voltage, $T_J = 25^\circ\text{C}$ )	$i_R$	250 5.0			500 10			$\mu\text{A}$
Maximum Reverse Recovery Time ( $I_F = 1.0\text{ A}$ , $di/dt = 50\text{ A}/\mu\text{s}$ ) ( $I_F = 0.5\text{ A}$ , $i_R = 1.0\text{ A}$ , $I_{REC} = 0.25\text{ A}$ )	$t_{rr}$	35 25			60 50		ns	

Product parametric performance is indicated in the Electrical Characteristics for the listed test conditions, unless otherwise noted. Product performance may not be indicated by the Electrical Characteristics if operated under different conditions.

1. Pulse Test: Pulse Width = 300  $\mu\text{s}$ , Duty Cycle  $\leq 2.0\%$ .

MUR805G, MUR810G, MUR815G, MUR820G, MUR840G, MUR860G, MURF860G,  
SUR8820G, SUR8840G

MUR805G, MUR810G, MUR815G, MUR820G, SUR8820G

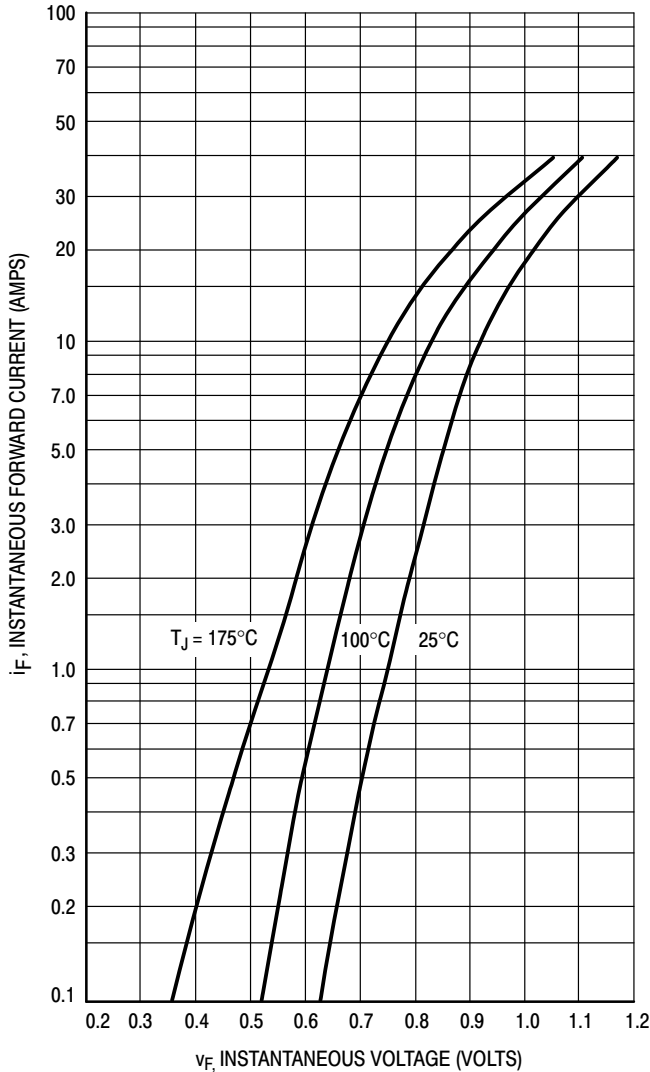

Figure 1. Typical Forward Voltage

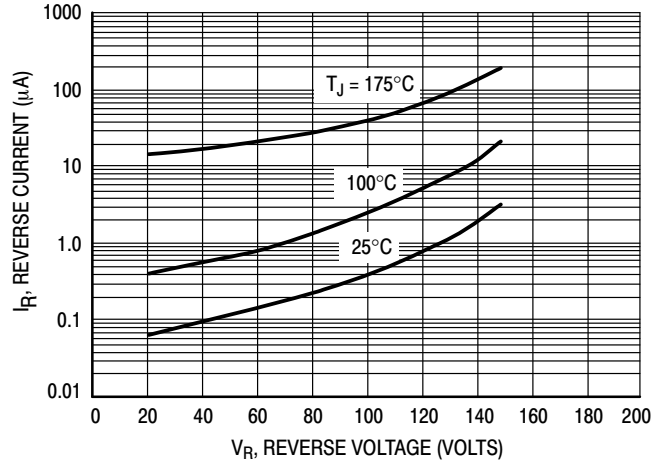

Figure 2. Typical Reverse Current\*

\* The curves shown are typical for the highest voltage device in the grouping. Typical reverse current for lower voltage selections can be estimated from these same curves if  $V_R$  is sufficiently below rated  $V_R$ .

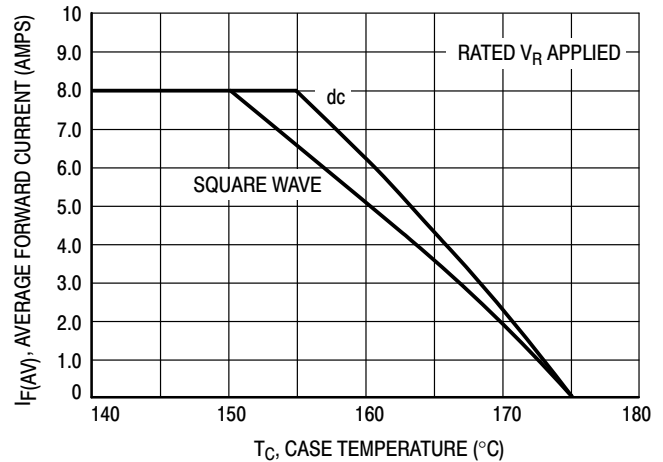

Figure 3. Current Derating, Case

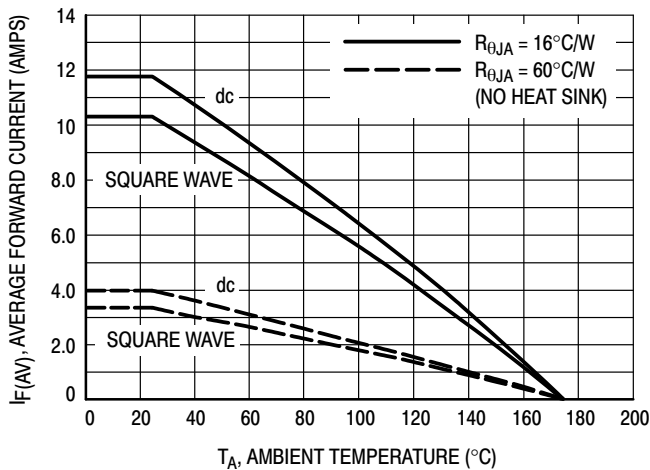

Figure 4. Current Derating, Ambient

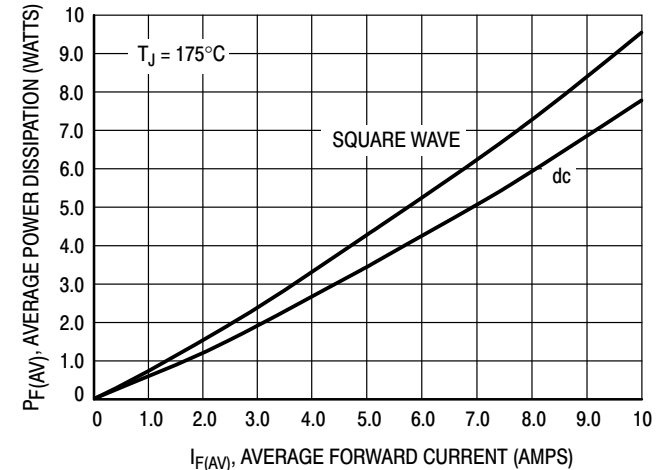

Figure 5. Power Dissipation

MUR805G, MUR810G, MUR815G, MUR820G, MUR840G, MUR860G, MURF860G,  
SUR8820G, SUR8840G

MUR840G, SUR8840G

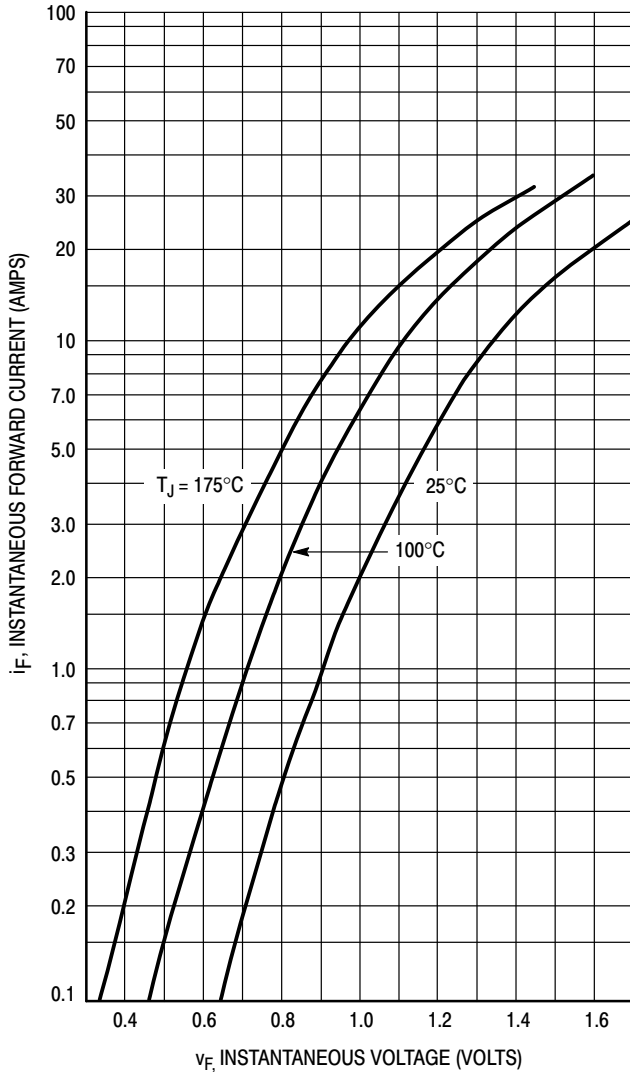

Figure 6. Typical Forward Voltage

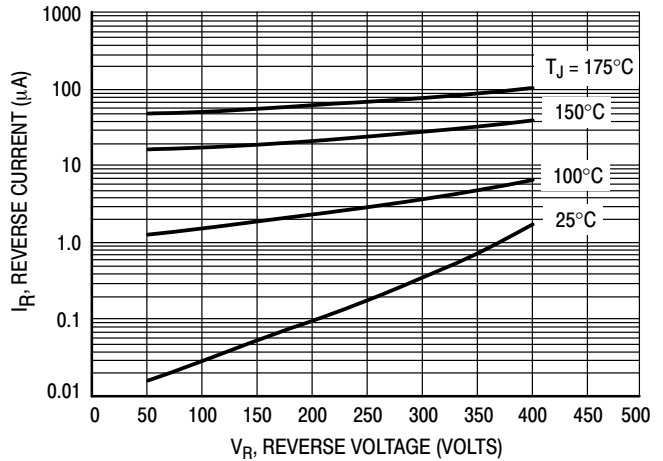

Figure 7. Typical Reverse Current\*

\* The curves shown are typical for the highest voltage device in the grouping. Typical reverse current for lower voltage selections can be estimated from these same curves if  $V_R$  is sufficiently below rated  $V_R$ .

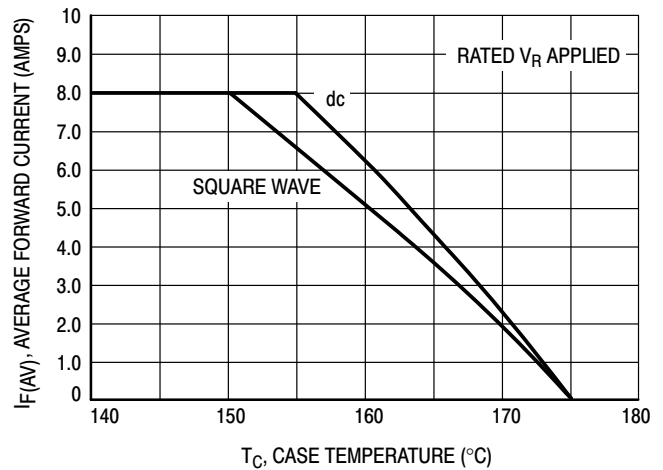

Figure 8. Current Derating, Case

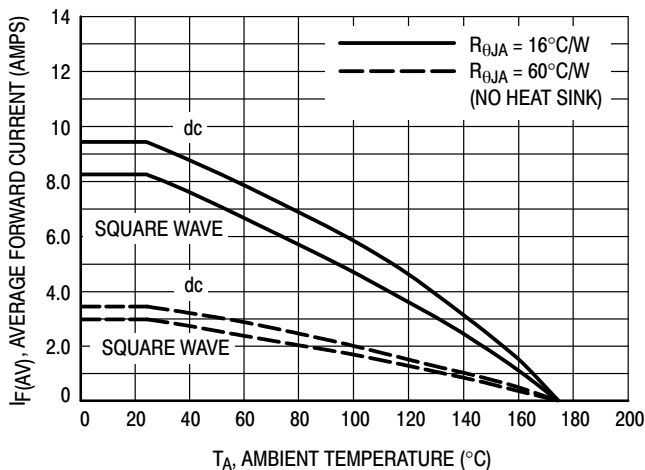

Figure 9. Current Derating, Ambient

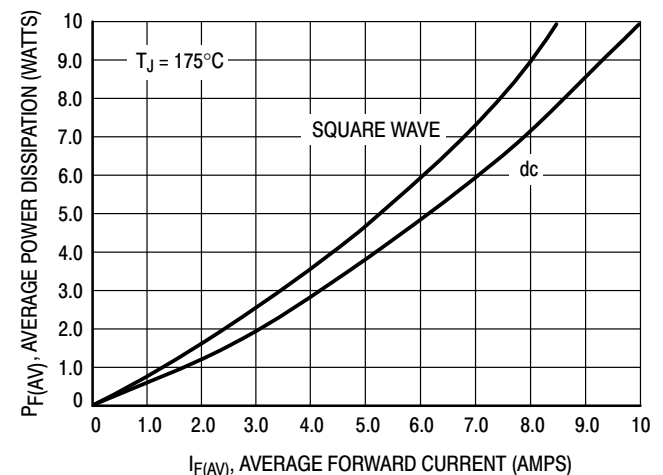

Figure 10. Power Dissipation

MUR805G, MUR810G, MUR815G, MUR820G, MUR840G, MUR860G, MURF860G,  
SUR8820G, SUR8840G

MUR860G, MURF860G

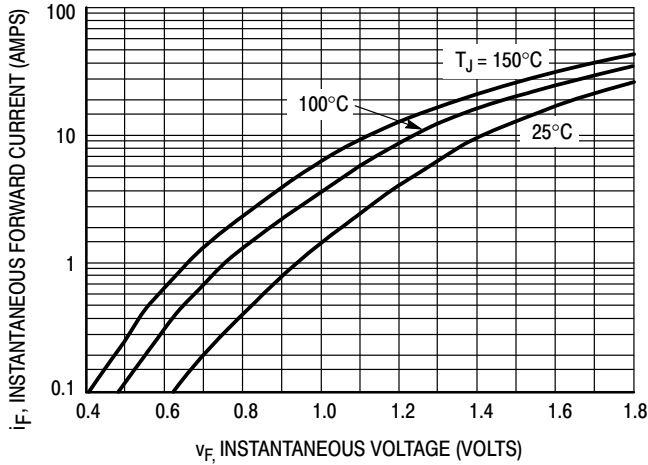

Figure 11. Typical Forward Voltage

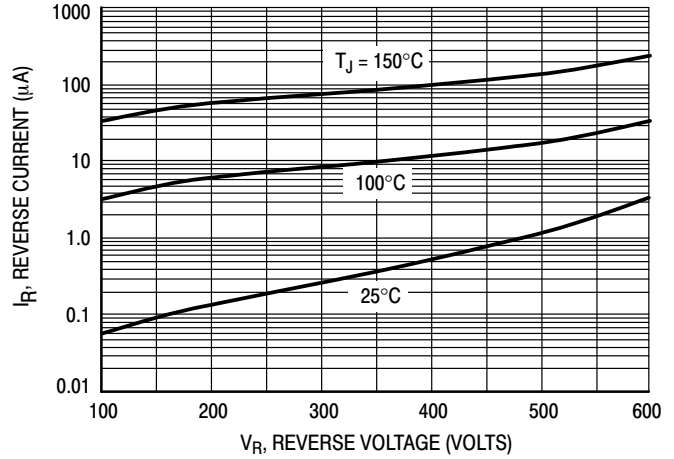

Figure 12. Typical Reverse Current\*

\* The curves shown are typical for the highest voltage device in the grouping. Typical reverse current for lower voltage selections can be estimated from these same curves if  $V_R$  is sufficiently below rated  $V_R$ .

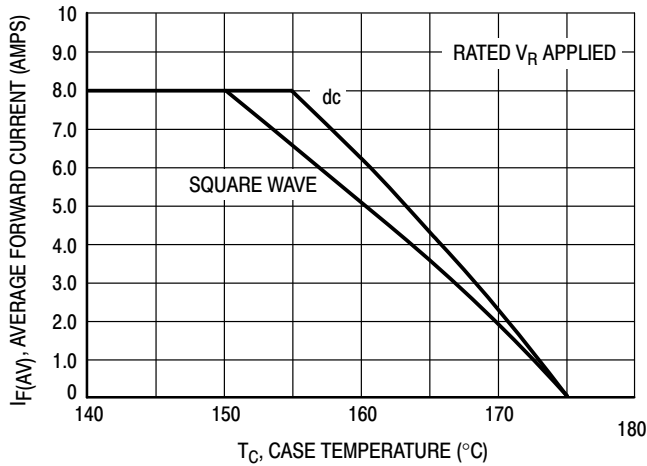

Figure 13. Current Derating, Case

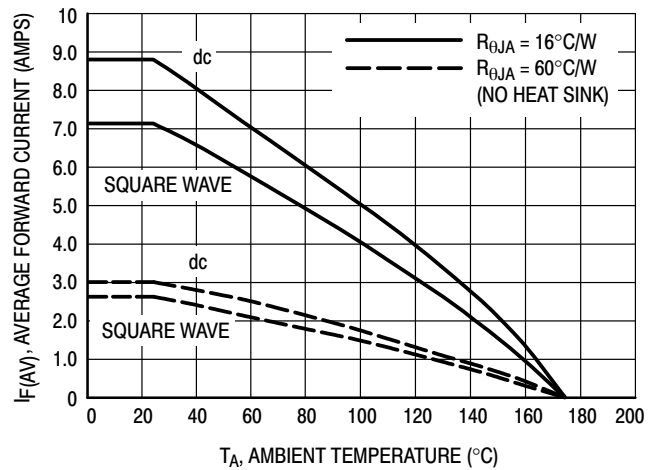

Figure 14. Current Derating, Ambient

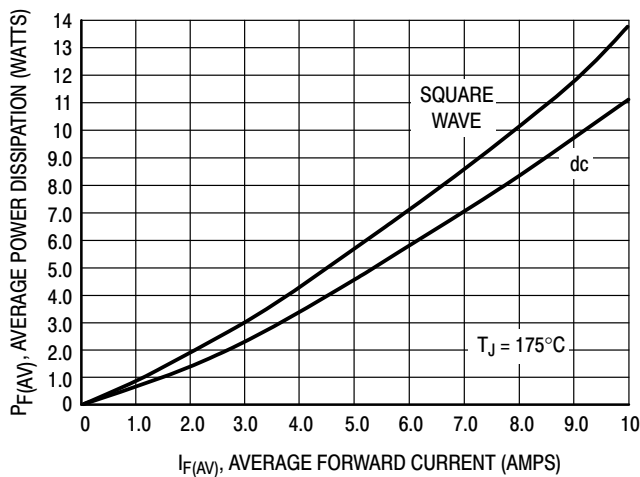

Figure 15. Power Dissipation

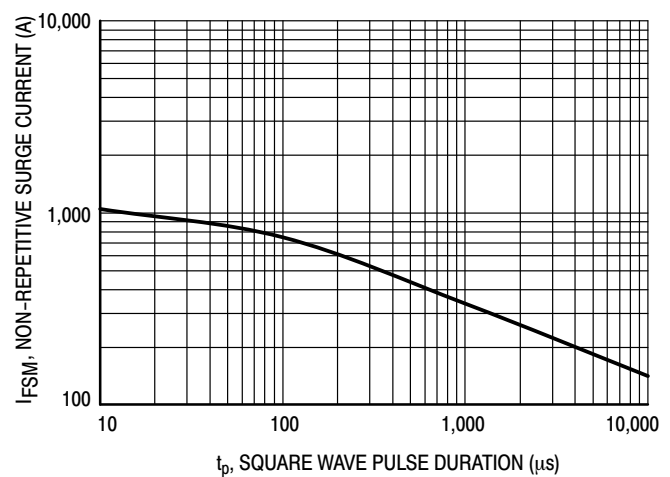
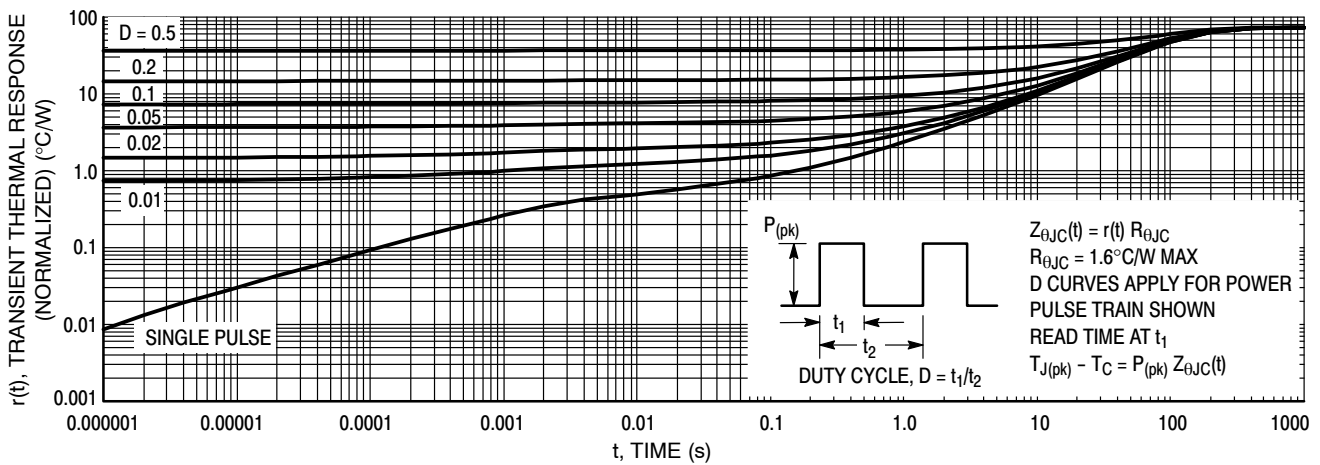
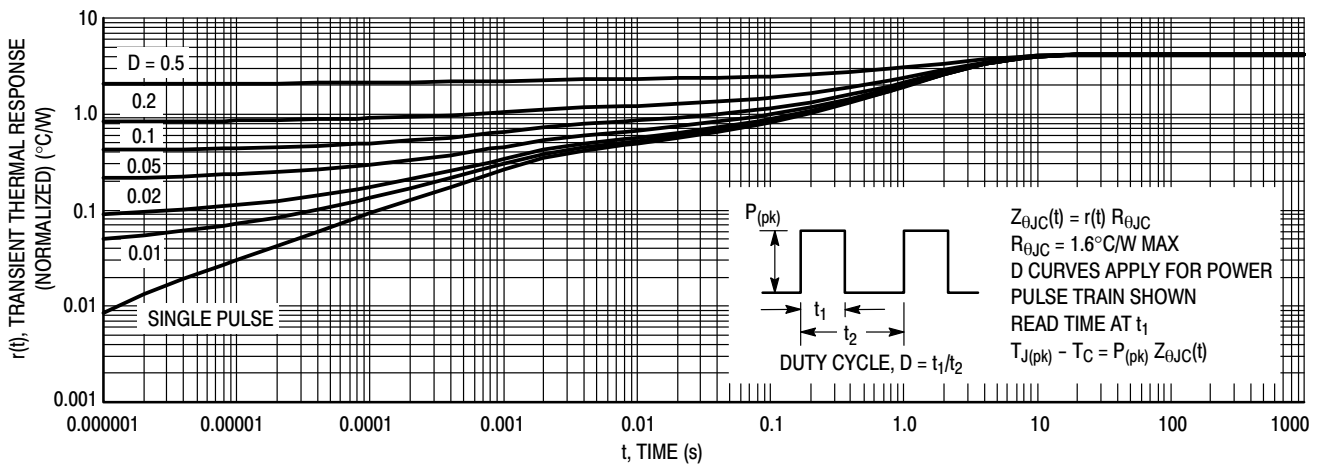
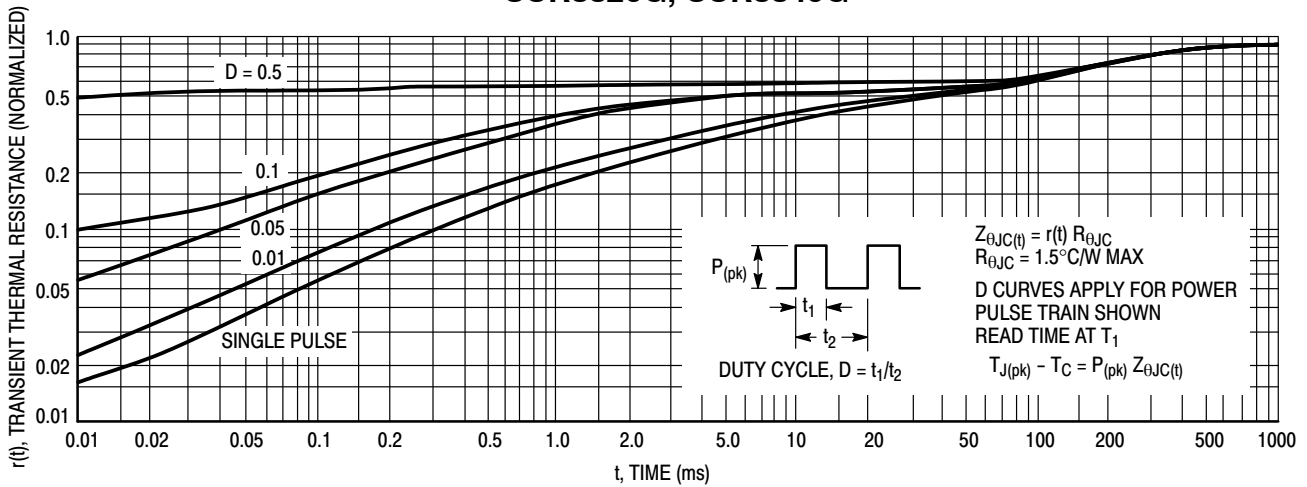

Figure 16. Typical Non-Repetitive Surge Current

\* Typical performance based on a limited sample size. ON Semiconductor does not guarantee ratings not listed in the Maximum Ratings table.

MUR805G, MUR810G, MUR815G, MUR820G, MUR840G, MUR860G, MURF860G,  
SUR8820G, SUR8840G



**MUR805G, MUR810G, MUR815G, MUR820G, MUR840G, MUR860G, MURF860G,  
SUR8820G, SUR8840G**

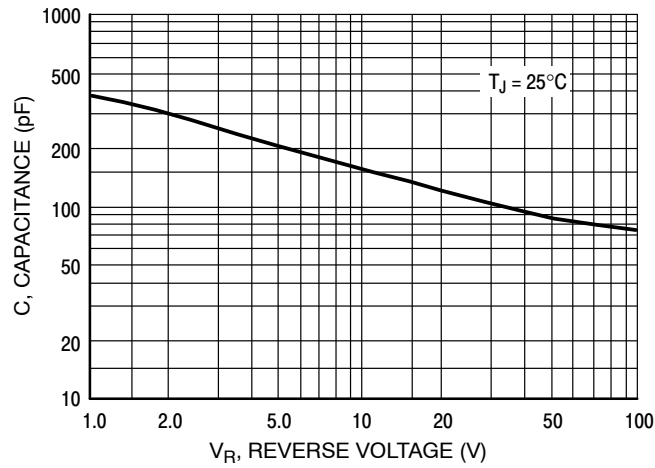

**Figure 20. Typical Capacitance**

**ORDERING INFORMATION**

Device	Package	Shipping
MUR805G	TO-220AC (Pb-Free)	50 Units / Rail
MUR810G	TO-220AC (Pb-Free)	50 Units / Rail
MUR815G	TO-220AC (Pb-Free)	50 Units / Rail
MUR820G	TO-220AC (Pb-Free)	50 Units / Rail
SUR8820G	TO-220AC (Pb-Free)	50 Units / Rail
MUR840G	TO-220AC (Pb-Free)	50 Units / Rail
SUR8840G	TO-220AC (Pb-Free)	50 Units / Rail
MUR860G	TO-220AC (Pb-Free)	50 Units / Rail
MURF860G	TO-220FP (Pb-Free)	50 Units / Rail

# MUR805G, MUR810G, MUR815G, MUR820G, MUR840G, MUR860G, MURF860G, SUR8820G, SUR8840G

## PACKAGE DIMENSIONS

### TO-220 TWO-LEAD CASE 221B-04 ISSUE F

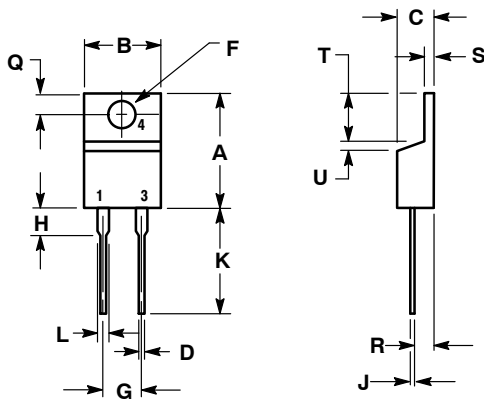

- NOTES:  
1. DIMENSIONING AND TOLERANCING PER ANSI Y14.5M, 1982.  
2. CONTROLLING DIMENSION: INCH.

DIM	INCHES		MILLIMETERS	
	MIN	MAX	MIN	MAX
A	0.595	0.620	15.11	15.75
B	0.380	0.405	9.65	10.29
C	0.160	0.190	4.06	4.82
D	0.025	0.039	0.64	1.00
F	0.142	0.161	3.61	4.09
G	0.190	0.210	4.83	5.33
H	0.110	0.130	2.79	3.30
J	0.014	0.025	0.36	0.64
K	0.500	0.562	12.70	14.27
L	0.045	0.060	1.14	1.52
Q	0.100	0.120	2.54	3.04
R	0.080	0.110	2.04	2.79
S	0.045	0.055	1.14	1.39
T	0.235	0.255	5.97	6.48
U	0.000	0.050	0.000	1.27

- STYLE 1:  
PIN 1. CATHODE  
2. N/A  
3. ANODE  
4. CATHODE

### TO-220 FULLPAK, 2-LEAD CASE 221AG ISSUE A

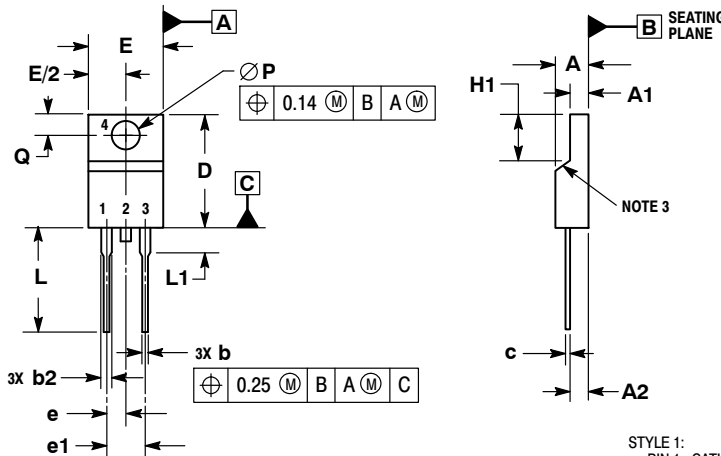

- NOTES:  
1. DIMENSIONING AND TOLERANCING PER ASME Y14.5M, 1994.  
2. CONTROLLING DIMENSION: MILLIMETERS.  
3. CONTOUR UNCONTROLLED IN THIS AREA.  
4. DIMENSIONS D AND E DO NOT INCLUDE MOLD FLASH AND GATE PROTRUSIONS. MOLD FLASH AND GATE PROTRUSIONS NOT TO EXCEED 0.13 PER SIDE. THESE DIMENSIONS ARE TO BE MEASURED AT OUTERMOST EXTREME OF THE PLASTIC BODY.  
5. DIMENSION b2 DOES NOT INCLUDE DAMBAR PROTRUSION. LEAD WIDTH INCLUDING PROTRUSION SHALL NOT EXCEED 2.00.

DIM	MILLIMETERS	
	MIN	MAX
A	4.30	4.70
A1	2.50	2.90
A2	2.50	2.90
b	0.54	0.84
b2	1.10	1.40
c	0.49	0.79
D	14.22	15.88
E	9.65	10.67
e	2.54 BSC	
e1	5.08 BSC	
H1	5.97	6.48
L	12.70	14.73
L1	---	2.80
P	3.00	3.40
Q	2.80	3.20

- STYLE 1:  
PIN 1. CATHODE  
2. N/A  
3. ANODE

ON Semiconductor and are registered trademarks of Semiconductor Components Industries, LLC (SCILLC). SCILLC owns the rights to a number of patents, trademarks, copyrights, trade secrets, and other intellectual property. A listing of SCILLC's product/patent coverage may be accessed at [www.onsemi.com/site/pdf/Patent-Marking.pdf](http://www.onsemi.com/site/pdf/Patent-Marking.pdf). SCILLC reserves the right to make changes without further notice to any products herein. SCILLC makes no warranty, representation or guarantee regarding the suitability of its products for any particular purpose, nor does SCILLC assume any liability arising out of the application or use of any product or circuit, and specifically disclaims any and all liability, including without limitation special, consequential or incidental damages. "Typical" parameters which may be provided in SCILLC data sheets and/or specifications can and do vary in different applications and actual performance may vary over time. All operating parameters, including "Typicals" must be validated for each customer application by customer's technical experts. SCILLC does not convey any license under its patent rights nor the rights of others. SCILLC products are not designed, intended, or authorized for use as components in systems intended for surgical implant into the body, or other applications intended to support or sustain life, or for any other application in which the failure of the SCILLC product could create a situation where personal injury or death may occur. Should Buyer purchase or use SCILLC products for any such unintended or unauthorized application, Buyer shall indemnify and hold SCILLC and its officers, employees, subsidiaries, affiliates, and distributors harmless against all claims, costs, damages, and expenses, and reasonable attorney fees arising out of, directly or indirectly, any claim of personal injury or death associated with such unintended or unauthorized use, even if such claim alleges that SCILLC was negligent regarding the design or manufacture of the part. SCILLC is an Equal Opportunity/Affirmative Action Employer. This literature is subject to all applicable copyright laws and is not for resale in any manner.

## PUBLICATION ORDERING INFORMATION



**LITERATURE FULFILLMENT:**  
Literature Distribution Center for ON Semiconductor  
P.O. Box 5163, Denver, Colorado 80217 USA  
Phone: 303-675-2175 or 800-344-3860 Toll Free USA/Canada  
Fax: 303-675-2176 or 800-344-3867 Toll Free USA/Canada  
Email: [orderlit@onsemi.com](mailto:orderlit@onsemi.com)

**N. American Technical Support:** 800-282-9855 Toll Free  
USA/Canada  
**Europe, Middle East and Africa Technical Support:**  
Phone: 421 33 790 2910  
**Japan Customer Focus Center**  
Phone: 81-3-5817-1050

**ON Semiconductor Website:** [www.onsemi.com](http://www.onsemi.com)  
**Order Literature:** <http://www.onsemi.com/orderlit>  
For additional information, please contact your local Sales Representative

## Looking for pricing, stock, or lifecycle information?

Click below to explore more details on WIN SOURCE:

-  [View MUR805G on WIN SOURCE](#)
-  [ON Semiconductor Information](#)

## Optimize Your Supply Chain with WIN SOURCE Solutions

-  Global Sourcing Solution
-  Obsolete Management
-  Cost Control Management
-  Shortage Management
-  Alternative Solution
-  Excess Inventory Management