

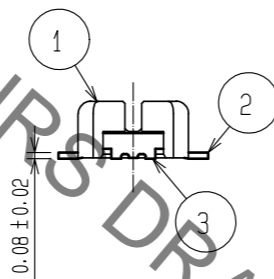

**THE DATASHEET OF
DF37B-10DP-0.4V(51)**

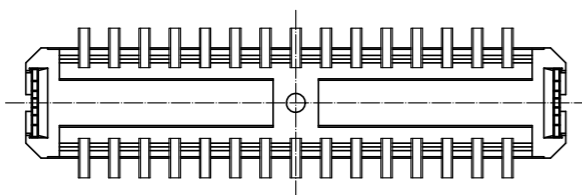

Sep.1.2019 Copyright 2019 HIROSE ELECTRIC CO., LTD. All Rights Reserved.
In case of consideration for using Automotive equipment / device which demand high reliability, kindly contact our sales window correspondents.

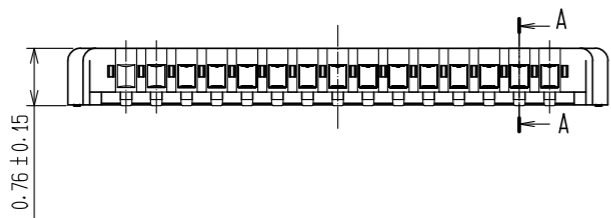
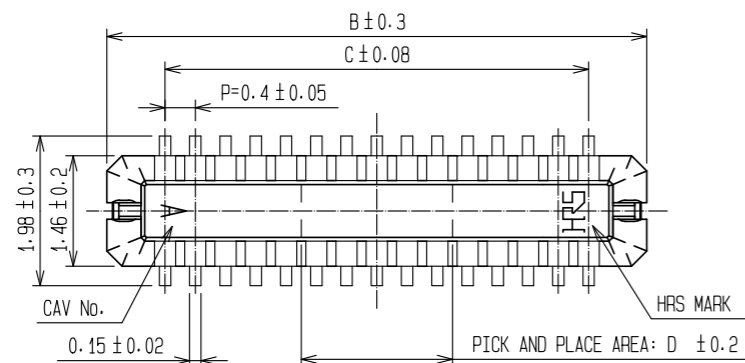

RECOMMENDED METAL MASK
OPENING PATTERN

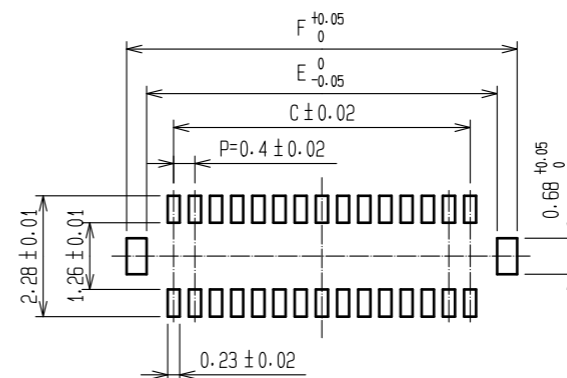

RECOMMENDED SOLDER PASTE THICKNESS : 120µm

RECOMMENDED PATTERN

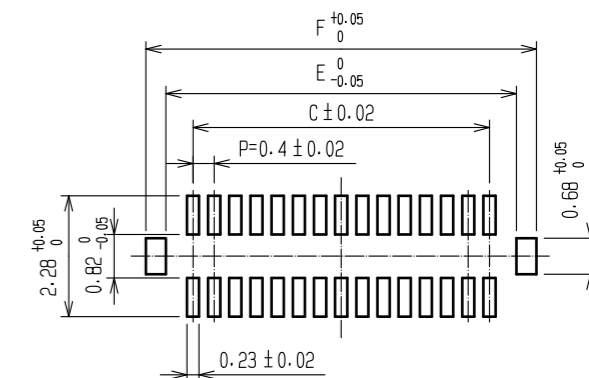

ENGAGEMENT FIGURE

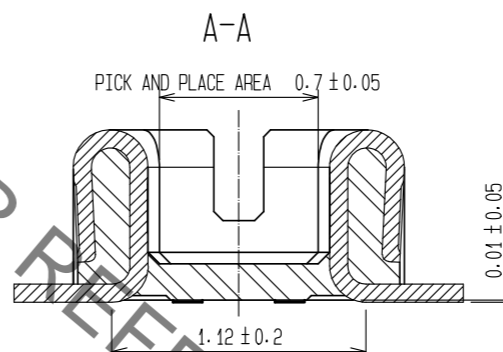
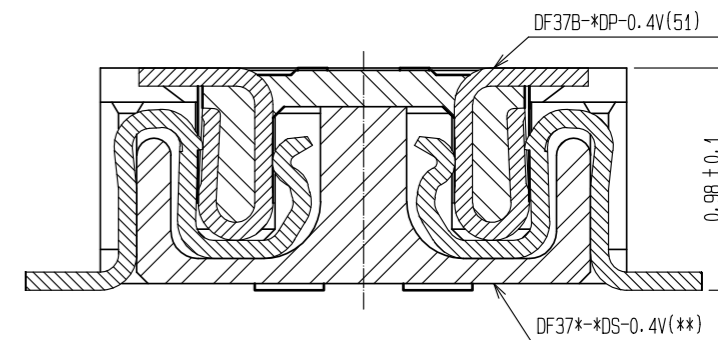

- NOTE 1. ALL LEADS CO-PLANARITY SHALL BE 0.1 MAX.
 2. PER REEL : 8000 CONNECTORS.
 3. AT THE BEGINNING OF THE REEL, 100 mm AT MIN SHALL BE EMPTY POCKETS.
 AT THE END OF THE REEL, 160 mm AT MIN SHALL BE EMPTY.
4. CONTACT PLATING SPECIFICATIONS.
 CONTACT AREA : GOLD 0.05µm MIN.
 SMT LEAD : GOLD 0.05µm MIN.
 UNDERPLATING : NICKEL 1µm MIN.
 (SURFACE : SEALING)
5. METAL HOLD DOWN PLATING SPECIFICATIONS.
 MOUNTING AREA: GOLD 0.05µm MIN.
 UNDERPLATING : NICKEL 1µm MIN.
6. PEEL FORCE OF COVER TAPE REFERS TO JIS C 0806.

PART No.	CODE No.	B	C	D	E	F
DF37B -10DP-0.4V(51)	CL684-3037-0-51	3.14	1.6	0.8	2.62	3.38
DF37B -16DP-0.4V(51)	CL684-3057-7-51	4.34	2.8	1.2	3.82	4.58
DF37B -20DP-0.4V(51)	CL684-3008-1-51	5.14	3.6	1.6	4.62	5.38
DF37B -24DP-0.4V(51)	CL684-3009-4-51	5.94	4.4	2	5.42	6.18
DF37B -30DP-0.4V(51)	CL684-3010-3-51	7.14	5.6	2	6.62	7.38
DF37B -34DP-0.4V(51)	CL684-3064-2-51	7.94	6.4	2.4	7.42	8.18
DF37B -40DP-0.4V(51)	CL684-3011-6-51	9.14	7.6	2.4	8.62	9.38
DF37B -44DP-0.4V(51)	CL684-3408-0-51	9.94	8.4	2.8	9.42	10.18
DF37B -50DP-0.4V(51)	CL684-3012-9-51	11.14	9.6	2.8	10.62	11.38
DF37B -60DP-0.4V(51)	CL684-3013-1-51	13.14	11.6	3.2	12.62	13.38
DF37B -70DP-0.4V(51)	CL684-3014-4-51	15.17	13.6	3.6	14.62	15.38
DF37B -74DP-0.4V(51)	CL684-3071-8-51	15.94	14.4	3.6	15.42	16.18

3	PHOSPHOR BRONZE	5	6	PS	PLASTIC REEL (BLACK)		
2	PHOSPHOR BRONZE	4	5	POLYESTER	CLEAR(COVER TAPE)		
1	LCP	UL94V-0, BLACK	4	PS	CLEAR(EMBOSSED CARRIER TAPE)		
NO.	MATERIAL	FINISH, REMARKS	NO.	MATERIAL	FINISH, REMARKS		
UNITS	mm	SCALE	COUNT	DESCRIPTION OF REVISIONS	DESIGNED	CHECKED	DATE
		FREE	2	DIS-H-00002725	YT. TAKAGI	TS. MIYAZAKI	17.09.28
APPROVED : MO. NAKAMURA		07.01.30	DRAWING NO.		EDC3-314914-01		
CHECKED : KH. IKEDA		07.01.30	PART NO.		DF37B-*DP-0.4V(51)		
DESIGNED : KY. MIDORIKAWA		07.01.30	CODE NO.		CL684		
DRAWN : KY. MIDORIKAWA		07.01.30					

Sep.1.2019 Copyright 2019 HIROSE ELECTRIC CO., LTD. All Rights Reserved.
 In case of consideration for using Automotive equipment / device which demand high reliability, kindly contact our sales window correspondents.

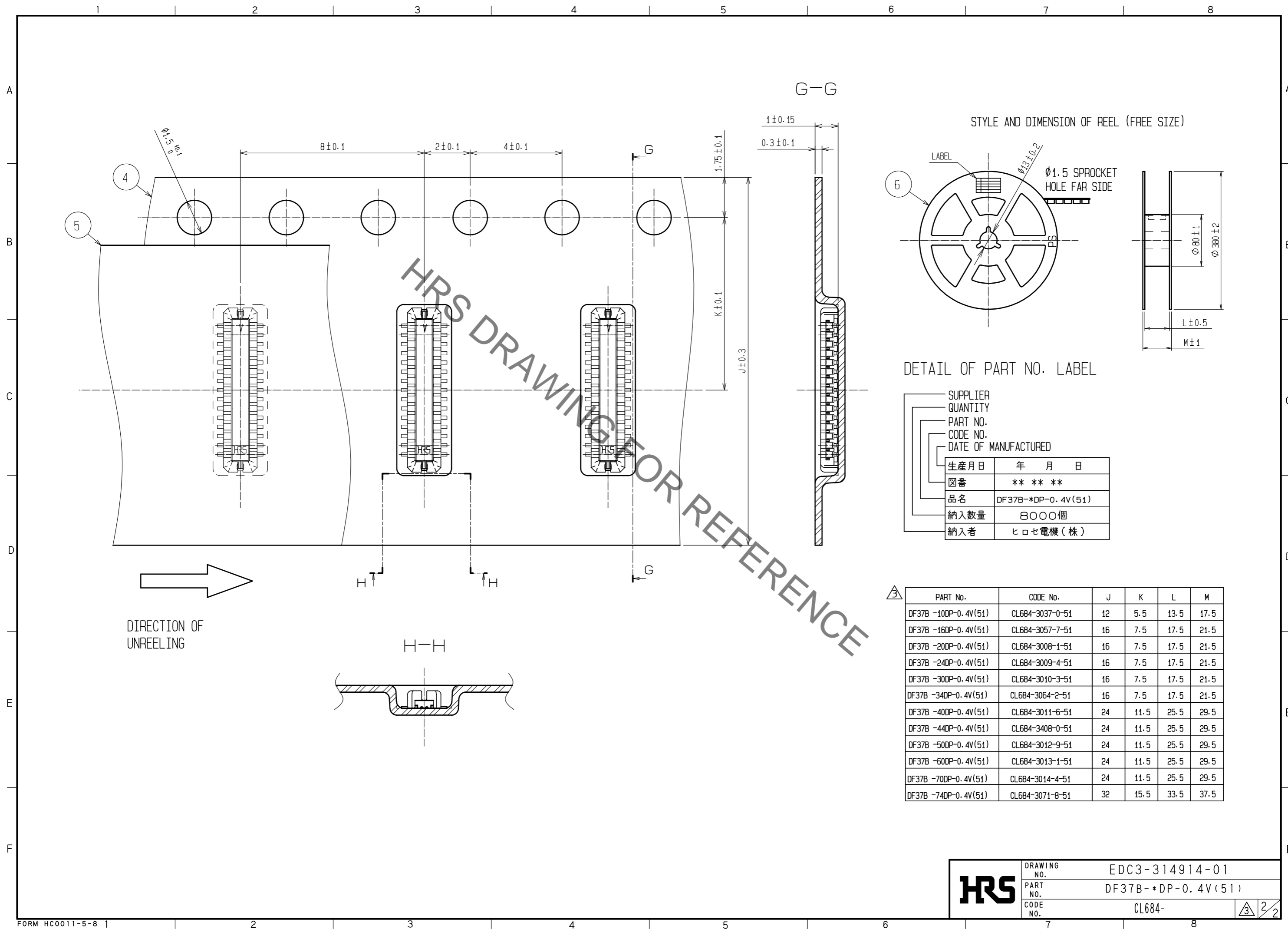



HRS	DRAWING NO.	EDC3-314914-01
	PART NO.	DF37B-*DP-0.4V(51)
	CODE NO.	CL684-

3/2

Looking for pricing, stock, or lifecycle information?

Click below to explore more details on WIN SOURCE:

-  [View DF37B-10DP-0.4V\(51\) on WIN SOURCE](#)
-  [Hirose Electric Co Ltd Information](#)

Optimize Your Supply Chain with WIN SOURCE Solutions

-  Global Sourcing Solution
-  Obsolete Management
-  Cost Control Management
-  Shortage Management
-  Alternative Solution
-  Excess Inventory Management