

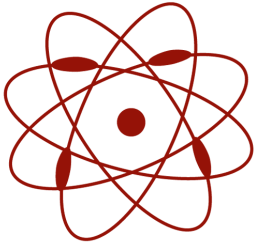

**THE DATASHEET OF
AT-3045-TF-LW110-R**





puj
audio™
a projects unlimited company
inc

3541 Stop Eight Road • Dayton, Ohio 45414

AT-3045-TF-LW110-R 30mm Transducer



Product Overview

- 30mm diameter piezo-electric transducer with 110mm 28 AWG UL 1095 wire leads
- 97 dBA minimum output (10 Vp-p @ 10 cm) and 4.5 kHz resonant frequency
- ABS housing with mounting tabs for M1.6 or #1 screws
- Consumes only 11 mA of current at rated voltage

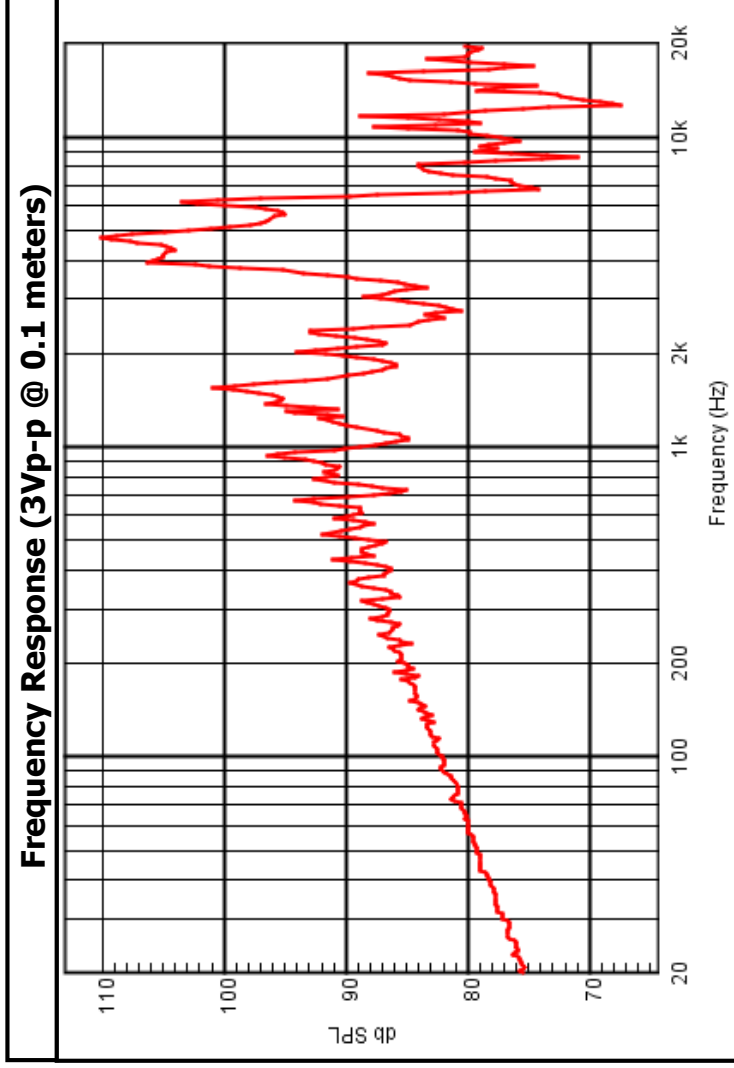

2018 PUI Audio, Inc. All rights reserved.

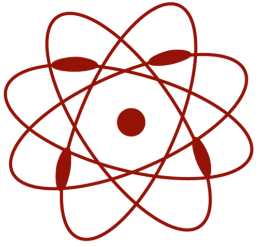

puj
audio™
inc
a projects unlimited company

AT-3045-TF-LW110-R 30mm Transducer

Mechanical and Environment Testing	
Test Description	Test Condition
High Temperature	95°C (±2°C) with random humidity for 240 hours
Low Temperature	-40°C (±2°C) with random humidity for 240 hours
Humidity	40°C (±2°C) with 90% to 95% relative humidity for 240 hours
Vibration	1.5 mm movement modulated at 10-55 Hz in 3 axis for 2 hours
Drop Test	75 cm free fall onto wood board, 9 cycles
Temperature Cycle Test	-40°C to 95°C, ten 3 hour cycles

After tests, part shall rest for 2 hours. Parts are then tested for clean, pure tones.

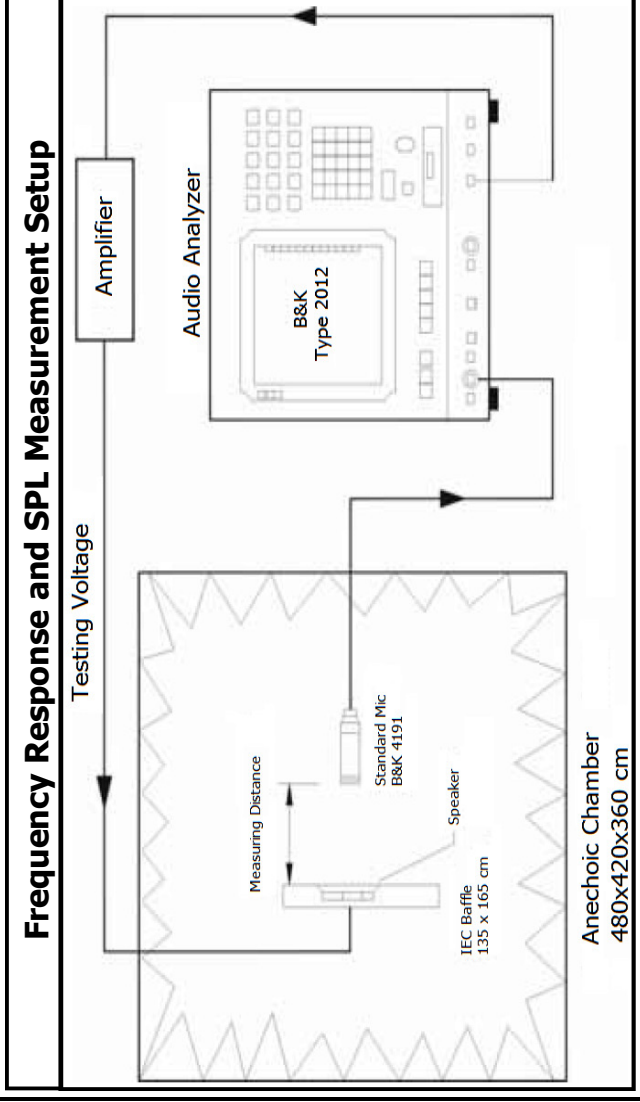
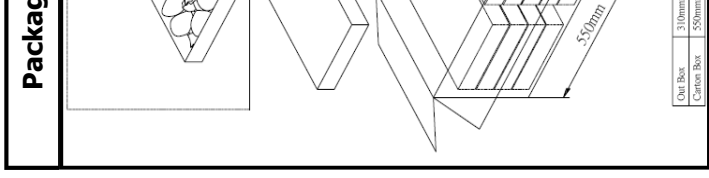
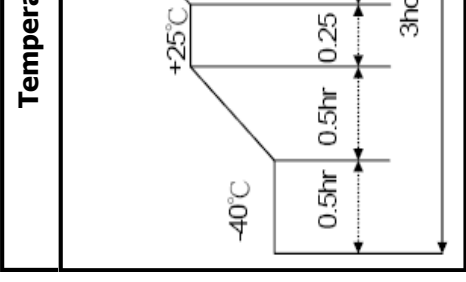

SPECIFICATIONS

PARAMETERS	VALUES	UNITS
RATED VOLTAGE	10	Vp-p
OPERATING VOLTAGE RANGE	1 ~ 50	Vp-p
RATED CURRENT (MAX)	11	mA
CAPACITANCE	18,000 ± 30%	pF
MINIMUM SPL @ 10 CM	97	dBA
RESONANT FREQUENCY	4,500 ± 500	Hz
OPERATING TEMPERATURE	-30 ~ +85	°C
STORAGE TEMPERATURE	-40 ~ +95	°C
HOUSING MATERIAL	ABS	-
TERMINAL MATERIAL	LEAD WIRE	-
WEIGHT	5	grams

THIS DOCUMENT CONTAINS DATA PROPRIETARY TO PROJECTS UNLIMITED, INC. ANY USE OR REPRODUCTION, IN ANY FORM, WITHOUT PRIOR WRITTEN PERMISSION OF PROJECTS UNLIMITED, INC. IS PROHIBITED.
©2003, Projects Unlimited Inc.

LTR	REVISION HIST
-	DESCRIPTION
A	RELEASED FROM ENGINEERING REVISED TO INVENTOR 3-D DRAWING TEMPLATE

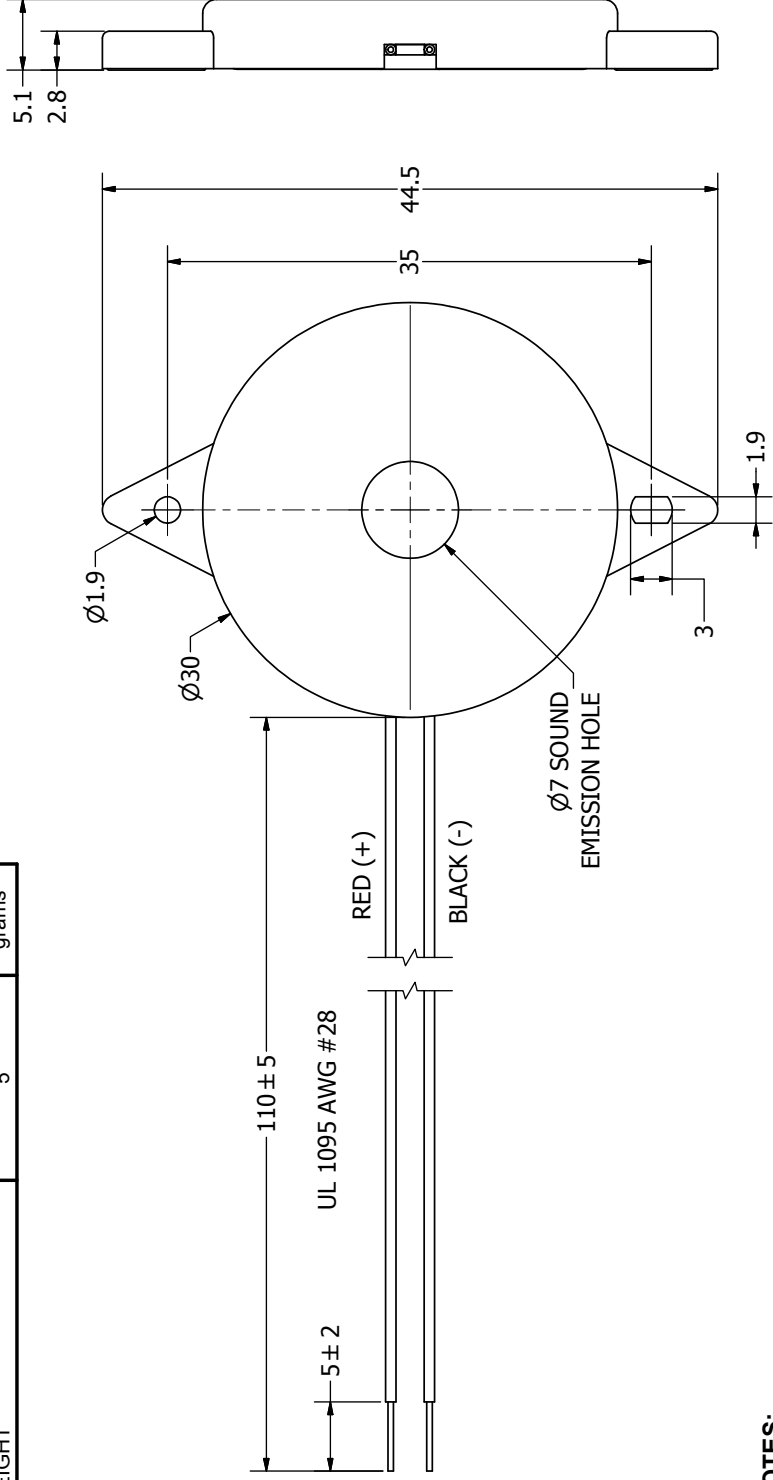

NOTES:

1. ALL DIMENSIONS ARE IN MILLIMETERS.
2. SPECIFICATIONS SUBJECT TO CHANGE OR WITHDRAWAL WITHOUT NOTICE.
3. THIS PART IS RoHS 2002/95/EC COMPLIANT.

UNLESS OTHERWISE SPECIFIED:

DIMENSIONS ARE IN MILLIMETERS,

TOLERANCES ARE ±0.5 AND ANGLES ARE ±3°.

SIZE

A3

AT-3045-TF-LW110-R.idw

Designed by
J.D.

Date
7/31/2006

Checked by
E.P.

Date
8/9/2006





pui audio
inc
a projects unlimited company

AT-3045

Transco

Looking for pricing, stock, or lifecycle information?

Click below to explore more details on WIN SOURCE:

-  [View AT-3045-TF-LW110-R on WIN SOURCE](#)
-  [PUI Audio, Inc. Information](#)

Optimize Your Supply Chain with WIN SOURCE Solutions

-  Global Sourcing Solution
-  Obsolete Management
-  Cost Control Management
-  Shortage Management
-  Alternative Solution
-  Excess Inventory Management