



**THE DATASHEET OF  
4816P-3-181/391LF**





## Features

- RoHS compliant\* (see How to Order "Termination" option)
- Standard EIA package compatible with automatic placement equipment
- Tape and reel packaging standard
- Custom circuits are available
- Compliant leads to reduce solder joint fatiguing
- Standard electrical schematics: isolated, bussed, dual terminator
- Now available with improved tolerance to  $\pm 0.5\%$

## 4800P Series - Thick Film Surface Mounted Medium Body

### Product Characteristics

Resistance Range ..... 10 ohms to 2.2 megohms  
 Maximum Operating Voltage ..... 50 V  
 Temperature Coefficient of Resistance  
 50  $\Omega$  and above .....  $\pm 100$  ppm/ $^{\circ}\text{C}$   
 below 50  $\Omega$  .....  $\pm 250$  ppm/ $^{\circ}\text{C}$   
 TCR Tracking  
 (for equal values within a package)  
 ..... 50 ppm/ $^{\circ}\text{C}$  max. for values > 50  $\Omega$ ;  
 ..... 100 ppm/ $^{\circ}\text{C}$  for values  $\leq$  50  $\Omega$   
 Operating Temperature  
 ..... -55  $^{\circ}\text{C}$  to +125  $^{\circ}\text{C}$   
 Insulation Resistance  
 ..... 10,000 megohms min.  
 Dielectric Withstanding Voltage  
 ..... 200 VRMS  
 Lead Solderability ..... Meet requirements  
 of MIL-STD-202 Method 208

### Environmental Characteristics

TESTS PER MIL-STD-202 .....  $\Delta R$  MAX.  
 Short Time Overload .....  $\pm 0.25\%$   
 Load Life .....  $\pm 1.00\%$   
 Moisture Resistance .....  $\pm 0.50\%$   
 Resistance to Soldering Heat .....  $\pm 0.25\%$   
 Thermal Shock .....  $\pm 0.25\%$

### Physical Characteristics

Flammability ..... Conforms to UL94V-0  
 Lead Frame Material  
 ..... Copper, solder coated  
 Body Material ..... Thermoplastic

### How To Order

**48 16 P - 1 - 103**

Model \_\_\_\_\_  
 (48 = SOM Pkg.)

Number of Pins \_\_\_\_\_

Electrical Configuration \_\_\_\_\_  
 • 1 or 4 = Isolated\*  
 • 2 = Bussed\*  
 • 3 = Dual Terminator\*

Resistance Code \_\_\_\_\_  
 • First 2 digits are significant  
 • Third digit represents the number of zeros to follow.

Resistance Tolerance \_\_\_\_\_  
 • Blank =  $\pm 2\%$  (see "Resistance Tolerance" on next page for resistance range)  
 • F =  $\pm 1\%$  (100 ohms - 1 megohm)  
 • D =  $\pm 0.5\%$  (100 ohms - 1 megohm)

Terminations \_\_\_\_\_  
 • All electrical configurations EXCEPT T03:  
 LF = RoHS compliant  
 • ONLY electrical configuration T03:  
 L = RoHS compliant  
 • Blank = Tin/Lead-plated

\*For tube packaging, use T01, T02, T03 or T04.  
 Consult factory for other available options.

### Package Power Temp. Derating Curve



### Package Power Rating at 70 $^{\circ}\text{C}$

4814P	1.12 watts
4816P	1.28 watts
4818P	1.44 watts
4820P	1.60 watts

### Typical Part Marking

Represents total content. Layout may vary.

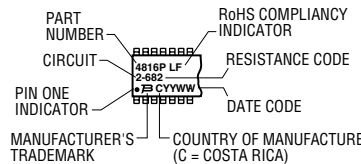

### Recommended Land Pattern



NOTE: Land pattern dimensions are based on  $\square$  design rules established by the Institute for Inter- $\square$  connecting and Packaging Electronic Circuits in  $\square$  IPC-SM-782.

For Standard Values Used in Capacitors, Inductors, and Resistors, [click here.](#)

### Product Dimensions



Lead coplanarity .102mm (.004 inch) max. at mounting surface.

Governing dimensions are in metric. Dimensions in parentheses are inches and are approximate.

\*Terminal centerline to centerline measurements made at point of emergence of the lead from the body.



**WARNING Cancer and Reproductive Harm**  
[www.P65Warnings.ca.gov](http://www.P65Warnings.ca.gov)

\*RoHS Directive 2002/95/EC Jan. 27, 2003 including annex and RoHS Recast 2011/65/EU June 8, 2011. Specifications are subject to change without notice.

Users should verify actual device performance in their specific applications.

The products described herein and this document are subject to specific legal disclaimers as set forth on the last page of this document, and at [www.bourns.com/docs/legal/disclaimer.pdf](http://www.bourns.com/docs/legal/disclaimer.pdf).

For information on specific applications, download Bourns' application notes:

- [DRAM Applications](#)
- [Dual Terminator Resistor Networks](#)
- [R/2R Ladder Networks](#)
- [SCSI Applications](#)

## 4800P Series - Thick Film Surface Mounted Medium Body **BOURNS®**

### Isolated Resistors (1 and 4 Circuits)

**Model 4814P-1**  
**Model 4816P-1 (Shown)**  
**Model 4818P-1**  
**Model 4820P-1**



**Model 4816P-4 (Shown)**  
**Model 4820P-4**

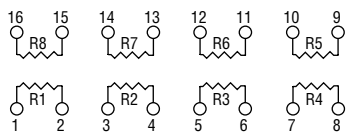

#### Resistance Tolerance

10 ohms to 49 ohms ..... ±1 ohm  
 50 ohms to 2.2 megohms ..... ±2 %\*

#### Power Rating per Resistor

1 Circuit at 70 °C ..... 0.160 watt  
 4 Circuit at 70 °C ..... 0.160 watt

### Resistor Power Temp. Derating Curve



### Bussed Resistors (2 Circuit)

**Model 4814P-2**  
**Model 4816P-2 (Shown)**  
**Model 4818P-2**  
**Model 4820P-2**

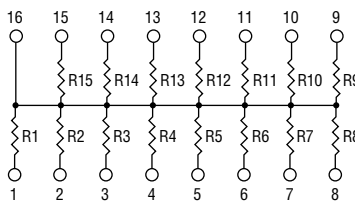

#### Resistance Tolerance

10 ohms to 49 ohms ..... ±1 ohm  
 50 ohms to 2.2 megohms ..... ±2 %\*

#### Power Rating per Resistor

2 Circuit at 70 °C ..... 0.080 watt

### Resistor Power Temp. Derating Curve

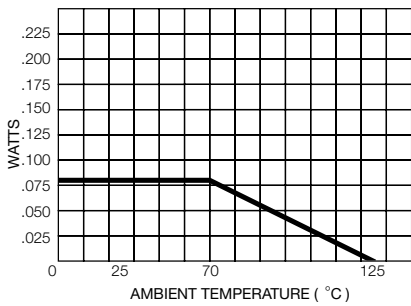

### Dual Terminator (3 Circuit)

**Model 4814P-3**  
**Model 4816P-3 (Shown)**  
**Model 4818P-3**  
**Model 4820P-3**



#### Resistance Tolerance

Below 100 ohms ..... ±2 ohms  
 100 ohms to 2.2 megohms ..... ±2 %\*

#### Power Rating per Resistor

3 Circuit at 70 °C ..... 0.080 watt

### Resistor Power Temp. Derating Curve



### Popular Resistance Values (1, 4 and 2 Circuits)\*\*

Ohms	Code	Ohms	Code	Ohms	Code	Ohms	Code	Ohms	Code
10	100	180	181	1,800	182	15,000	153	120,000	124
22	220	220	221	2,000	202	18,000	183	150,000	154
27	270	270	271	2,200	222	20,000	203	180,000	184
33	330	330	331	2,700	272	22,000	223	220,000	224
39	390	390	391	3,300	332	27,000	273	270,000	274
47	470	470	471	3,900	392	33,000	333	330,000	334
56	560	560	561	4,700	472	39,000	393	390,000	394
68	680	680	681	5,600	562	47,000	473	470,000	474
82	820	820	821	6,800	682	56,000	563	560,000	564
100	101	1,000	102	8,200	822	68,000	683	680,000	684
120	121	1,200	122	10,000	103	82,000	823	820,000	824
150	151	1,500	152	12,000	123	100,000	104	1,000,000	105

### Popular Resistance Values (3 Circuit)\*\*

Resistance			
Ohms		Code	
R <sub>1</sub>	R <sub>2</sub>	R <sub>1</sub>	R <sub>2</sub>
160	240	161	241
180	390	181	391
220	270	221	271
220	330	221	331
330	390	331	391
330	470	331	471
3,000	6,200	302	622

REV. 07/19

Specifications are subject to change without notice. Users should verify actual device performance in their specific applications. The products described herein and this document are subject to specific legal disclaimers as set forth on the last page of this document, and at [www.bourns.com/docs/legal/disclaimer.pdf](http://www.bourns.com/docs/legal/disclaimer.pdf).

\* Add "F" after resistance code for ±1 % tolerance available from 100 Ω through 1M Ω, or add "D" after resistance code for ±0.5 % tolerance available from 100 Ω through 1M Ω.  
 Part number suffix examples: -103 = 10K Ω, ±2 %; -103F = 10K Ω, ±1 %; -103D = 10K Ω, ±0.5 %  
 \*\* Non-standard values available, within resistance range.

# Surface Mount Ordering Guide

**BOURNS®**

Electrical Configuration	*Circuit Codes		Examples
	Tape & Reel	Tubes	
Isolated	1	T01	4816P-1-101
Bussed	2	T02	Isolated Circuit in Tape & Reel Package
Dual Terminated	3	T03	4816P-T01-101
Adj. Isolated	4	T04	Isolated Circuit in Slide Tube Package

\*4816P-X-RC: To specify package type, replace "X" with appropriate "Circuit Code".

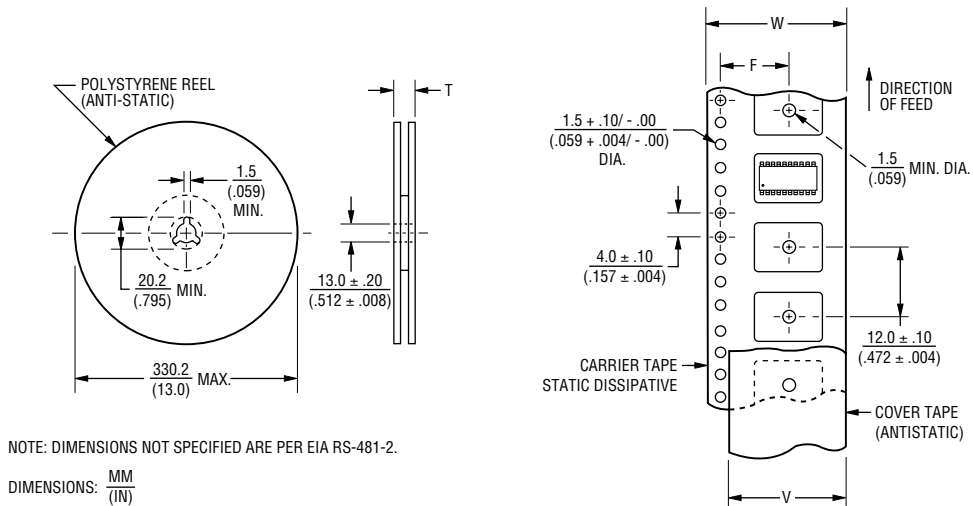

Model	Standard Quantity per Reel	Carrier Tape Width (W)	Cover Tape Width (W)	Reel Width (T)	Pocket Center (F)
4814P	2,000	$\frac{24.0 \pm .30}{(.945 \pm .012)}$	$\frac{21.0}{(.827)}$ NOM.	$\frac{30.4}{(1.197)}$ MAX.	$\frac{11.5 \pm .10}{(.453 \pm .004)}$
4816P					
4818P					
4820P					

Leader Length = 500 min. } Empty Component Pockets  
 Trailer Length = 500 mm min. } Sealed with Cover Tape

This legal disclaimer applies to purchasers and users of Bourns® products manufactured by or on behalf of Bourns, Inc. and its affiliates (collectively, "Bourns").

Unless otherwise expressly indicated in writing, Bourns® products and data sheets relating thereto are subject to change without notice. Users should check for and obtain the latest relevant information and verify that such information is current and complete before placing orders for Bourns® products.

The characteristics and parameters of a Bourns® product set forth in its data sheet are based on laboratory conditions, and statements regarding the suitability of products for certain types of applications are based on Bourns' knowledge of typical requirements in generic applications. The characteristics and parameters of a Bourns® product in a user application may vary from the data sheet characteristics and parameters due to (i) the combination of the Bourns® product with other components in the user's application, or (ii) the environment of the user application itself. The characteristics and parameters of a Bourns® product also can and do vary in different applications and actual performance may vary over time. Users should always verify the actual performance of the Bourns® product in their specific devices and applications, and make their own independent judgments regarding the amount of additional test margin to design into their device or application to compensate for differences between laboratory and real world conditions.

Unless Bourns has explicitly designated an individual Bourns® product as meeting the requirements of a particular industry standard (e.g., ISO/TS 16949) or a particular qualification (e.g., UL listed or recognized), Bourns is not responsible for any failure of an individual Bourns® product to meet the requirements of such industry standard or particular qualification. Users of Bourns® products are responsible for ensuring compliance with safety-related requirements and standards applicable to their devices or applications.

Bourns® products are not recommended, authorized or intended for use in nuclear, lifesaving, life-critical or life-sustaining applications, nor in any other applications where failure or malfunction may result in personal injury, death, or severe property or environmental damage. Unless expressly and specifically approved in writing by two authorized Bourns representatives on a case-by-case basis, use of any Bourns® products in such unauthorized applications might not be safe and thus is at the user's sole risk. Life-critical applications include devices identified by the U.S. Food and Drug Administration as Class III devices and generally equivalent classifications outside of the United States.

Bourns expressly identifies those Bourns® standard products that are suitable for use in automotive applications on such products' data sheets in the section entitled "Applications." Unless expressly and specifically approved in writing by two authorized Bourns representatives on a case-by-case basis, use of any other Bourns® standard products in an automotive application might not be safe and thus is not recommended, authorized or intended and is at the user's sole risk. If Bourns expressly identifies a sub-category of automotive application in the data sheet for its standard products (such as infotainment or lighting), such identification means that Bourns has reviewed its standard product and has determined that if such Bourns® standard product is considered for potential use in automotive applications, it should only be used in such sub-category of automotive applications. Any reference to Bourns® standard product in the data sheet as compliant with the AEC-Q standard or "automotive grade" does not by itself mean that Bourns has approved such product for use in an automotive application.

Bourns® standard products are not tested to comply with United States Federal Aviation Administration standards generally or any other generally equivalent governmental organization standard applicable to products designed or manufactured for use in aircraft or space applications. Bourns expressly identifies Bourns® standard products that are suitable for use in aircraft or space applications on such products' data sheets in the section entitled "Applications." Unless expressly and specifically approved in writing by two authorized Bourns representatives on a case-by-case basis, use of any other Bourns® standard product in an aircraft or space application might not be safe and thus is not recommended, authorized or intended and is at the user's sole risk.

The use and level of testing applicable to Bourns® custom products shall be negotiated on a case-by-case basis by Bourns and the user for which such Bourns® custom products are specially designed. Absent a written agreement between Bourns and the user regarding the use and level of such testing, the above provisions applicable to Bourns® standard products shall also apply to such Bourns® custom products.

Users shall not sell, transfer, export or re-export any Bourns® products or technology for use in activities which involve the design, development, production, use or stockpiling of nuclear, chemical or biological weapons or missiles, nor shall they use Bourns® products or technology in any facility which engages in activities relating to such devices. The foregoing restrictions apply to all uses and applications that violate national or international prohibitions, including embargos or international regulations. Further, Bourns® products and Bourns technology and technical data may not under any circumstance be exported or re-exported to countries subject to international sanctions or embargoes. Bourns® products may not, without prior authorization from Bourns and/or the U.S. Government, be resold, transferred, or re-exported to any party not eligible to receive U.S. commodities, software, and technical data.

To the maximum extent permitted by applicable law, Bourns disclaims (i) any and all liability for special, punitive, consequential, incidental or indirect damages or lost revenues or lost profits, and (ii) any and all implied warranties, including implied warranties of fitness for particular purpose, non-infringement and merchantability.

*For your convenience, copies of this Legal Disclaimer Notice with German, Spanish, Japanese, Traditional Chinese and Simplified Chinese bilingual versions are available at:*

*Web Page:* <http://www.bourns.com/legal/disclaimers-terms-and-policies>

*PDF:* <http://www.bourns.com/docs/Legal/disclaimer.pdf>



## Looking for pricing, stock, or lifecycle information?

Click below to explore more details on WIN SOURCE:

 [View 4816P-3-181/391LF on WIN SOURCE](#)

 [Bourns Inc. Information](#)

## Optimize Your Supply Chain with WIN SOURCE Solutions

-  Global Sourcing Solution
-  Obsolete Management
-  Cost Control Management
-  Shortage Management
-  Alternative Solution
-  Excess Inventory Management