



# TLC225x-Q1, TLC225xA-Q1 Advanced LinCMOS™ RAIL-TO-RAIL VERY LOW-POWER OPERATIONAL AMPLIFIERS

SGLS188B – OCTOBER 2003 – REVISED APRIL 2008

- Qualified for Automotive Applications
- ESD Protection Exceeds 2000 V Per MIL-STD-883, Method 3015; Exceeds 150 V (TLC2252/52A) and 100 V (TLC2254/54A) Using Machine Model (C = 200 pF, R = 0)
- Output Swing Includes Both Supply Rails
- Low Noise . . . 19 nV/√Hz Typ at f = 1 kHz
- Low Input Bias Current . . . 1 pA Typ
- Fully Specified for Both Single-Supply and Split-Supply Operation
- Very Low Power . . . 35 μA Per Channel Typ
- Common-Mode Input Voltage Range Includes Negative Rail
- Low Input Offset Voltage  
850 μV Max at T<sub>A</sub> = 25°C (TLC225xA)
- Macromodel Included
- Performance Upgrades for the TS27L2/L4 and TLC27L2/L4

## description

The TLC2252 and TLC2254 are dual and quadruple operational amplifiers from Texas Instruments. Both devices exhibit rail-to-rail output performance for increased dynamic range in single- or split-supply applications. The TLC225x family consumes only 35 μA of supply current per channel. This micropower operation makes them good choices for battery-powered applications. The noise performance has been dramatically improved over previous generations of CMOS amplifiers. Looking at Figure 1, the TLC225x has a noise level of 19 nV/√Hz at 1 kHz; four times lower than competitive micropower solutions.

The TLC225x amplifiers, exhibiting high input impedance and low noise, are excellent for small-signal conditioning for high-impedance sources, such as piezoelectric transducers. Because of the micropower dissipation levels, these devices work well in hand-held monitoring and remote-sensing applications. In addition, the rail-to-rail output feature with single or split supplies makes this family a great choice when interfacing with analog-to-digital converters (ADCs). For precision applications, the TLC225xA family is available and has a maximum input offset voltage of 850 μV. This family is fully characterized at 5 V and ±5 V.

The TLC2252/4 also makes great upgrades to the TLC27L2/L4 or TS27L2/L4 in standard designs. They offer increased output dynamic range, lower noise voltage, and lower input offset voltage. This enhanced feature set allows them to be used in a wider range of applications. For applications that require higher output drive and wider input voltage ranges, see the TLV2432 and TLV2442 devices. If the design requires single amplifiers, please see the TLV2211/21/31 family. These devices are single rail-to-rail operational amplifiers in the SOT-23 package. Their small size and low power consumption, make them ideal for high density, battery-powered equipment.

EQUIVALENT INPUT NOISE VOLTAGE  
vs  
FREQUENCY

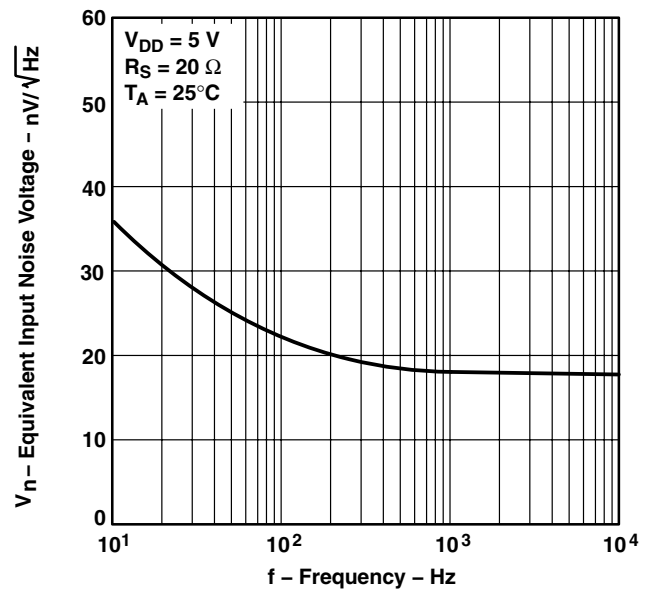

Figure 1



Please be aware that an important notice concerning availability, standard warranty, and use in critical applications of Texas Instruments semiconductor products and disclaimers thereto appears at the end of this data sheet.

Advanced LinCMOS is a trademark of Texas Instruments.

PRODUCTION DATA information is current as of publication date. Products conform to specifications per the terms of Texas Instruments standard warranty. Production processing does not necessarily include testing of all parameters.

 **TEXAS  
INSTRUMENTS**

POST OFFICE BOX 655303 • DALLAS, TEXAS 75265  
POST OFFICE BOX 1443 • HOUSTON, TEXAS 77251-1443

Copyright © 2008 Texas Instruments Incorporated

# TLC225x-Q1, TLC225xA-Q1

## Advanced LinCMOS™ RAIL-TO-RAIL

### VERY LOW-POWER OPERATIONAL AMPLIFIERS

SGLS188B – OCTOBER 2003 – REVISED APRIL 2008

#### ORDERING INFORMATION†

| T <sub>A</sub> | V <sub>IO</sub> max<br>AT 25°C | PACKAGE‡   |               | ORDERABLE<br>PART NUMBER | TOP-SIDE<br>MARKING |
|----------------|--------------------------------|------------|---------------|--------------------------|---------------------|
| -40°C to 125°C | 850 µV                         | SOIC (D)   | Tape and reel | TLC2252AQDRQ1            | 2252AQ              |
|                |                                | TSSOP (PW) | Tape and reel | TLC2252AQPWRQ1           | 2252AQ              |
|                | 1550 µV                        | SOIC (D)   | Tape and reel | TLC2252QDRQ1             | 2252Q1              |
|                |                                | TSSOP (PW) | Tape and reel | TLC2252QPWRQ1            | 2252Q1              |
|                | 850 µV                         | SOIC (D)   | Tape and reel | TLC2254AQDRQ1            | TLC2254AQ1          |
|                |                                | TSSOP (PW) | Tape and reel | TLC2254AQPWRQ1           | 2254AQ              |
|                | 1550 µV                        | SOIC (D)   | Tape and reel | TLC2254QDRQ1             | TLC2254Q1           |
|                |                                | TSSOP (PW) | Tape and reel | TLC2254QPWRQ1            | 2254Q1              |

† For the most current package and ordering information, see the Package Option Addendum at the end of this document, or see the TI web site at <http://www.ti.com>.

‡ Package drawings, thermal data, and symbolization are available at <http://www.ti.com/packaging>.

**TLC2252, TLC2252A**  
D OR PW PACKAGE  
(TOP VIEW)

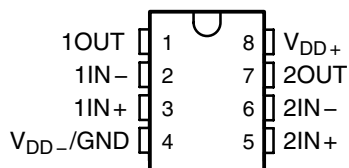

**TLC2254, TLC2254A**  
D OR PW PACKAGE  
(TOP VIEW)

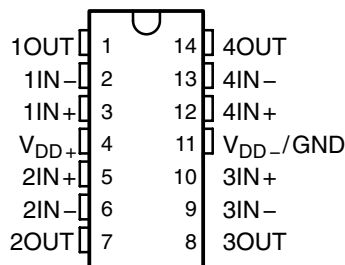

**TLC225x-Q1, TLC225xA-Q1**  
**Advanced LinCMOS™ RAIL-TO-RAIL**  
**VERY LOW-POWER OPERATIONAL AMPLIFIERS**

SGLS188B – OCTOBER 2003 – REVISED APRIL 2008

equivalent schematic (each amplifier)

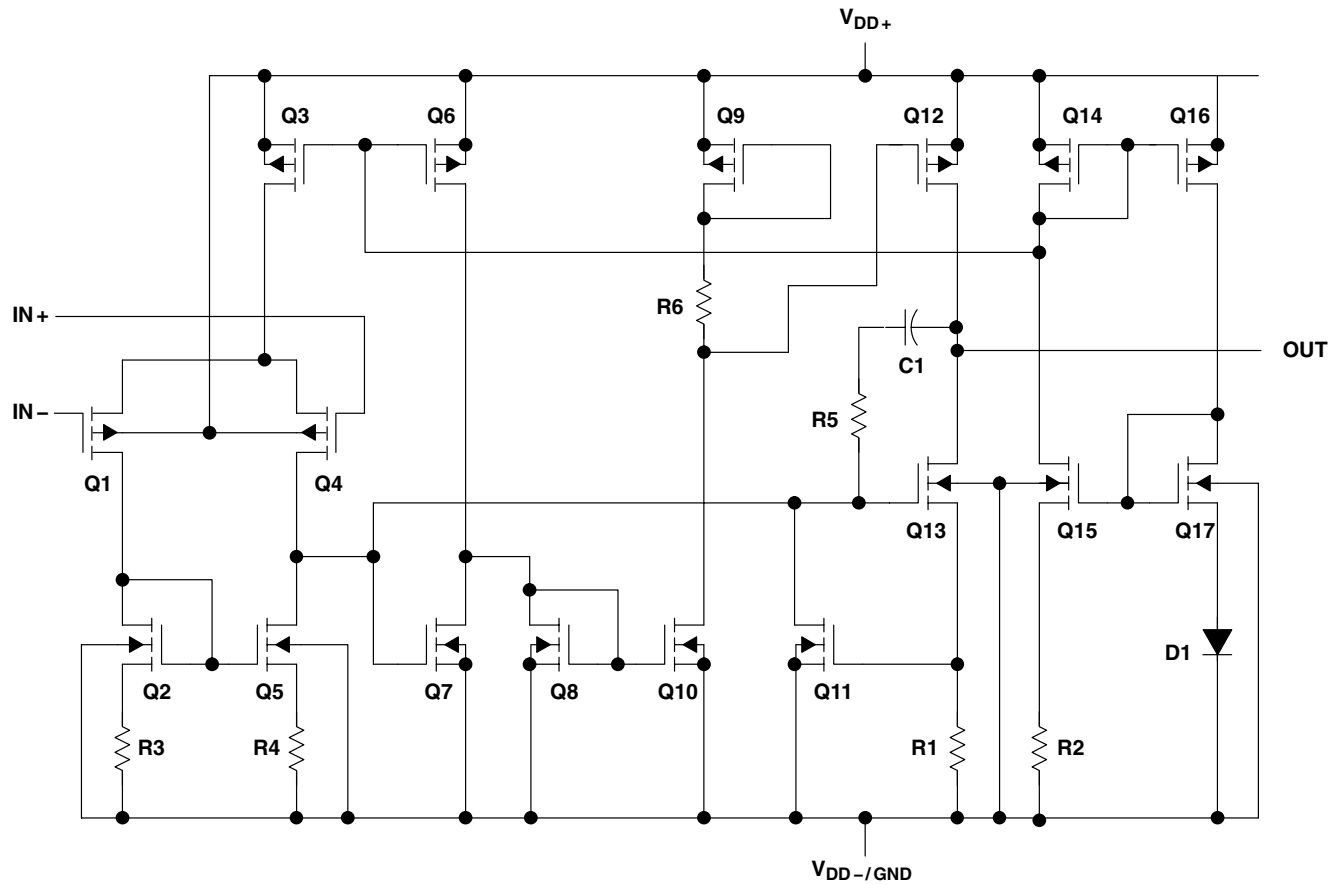

| ACTUAL DEVICE COMPONENT COUNT† |         |         |
|--------------------------------|---------|---------|
| COMPONENT                      | TLC2252 | TLC2254 |
| Transistors                    | 38      | 76      |
| Resistors                      | 30      | 56      |
| Diodes                         | 9       | 18      |
| Capacitors                     | 3       | 6       |

† Includes both amplifiers and all ESD, bias, and trim circuitry



**TLC225x-Q1, TLC225xA-Q1**  
**Advanced LinCMOS™ RAIL-TO-RAIL**  
**VERY LOW-POWER OPERATIONAL AMPLIFIERS**

SGLS188B – OCTOBER 2003 – REVISED APRIL 2008

**absolute maximum ratings over operating free-air temperature range (unless otherwise noted)†**

|   |                              |
|---|------------------------------|
| Supply voltage, $V_{DD+}$ (see Note 1)                            | 8 V                          |
| Supply voltage, $V_{DD-}$ (see Note 1)                            | -8 V                         |
| Differential input voltage, $V_{ID}$ (see Note 2)                 | $\pm 16$ V                   |
| Input voltage, $V_I$ (any input, see Note 1)                      | $\pm 8$ V                    |
| Input current, $I_I$ (each input)                                 | $\pm 5$ mA                   |
| Output current, $I_O$   | $\pm 50$ mA                  |
| Total current into $V_{DD+}$                                      | $\pm 50$ mA                  |
| Total current out of $V_{DD-}$                                    | $\pm 50$ mA                  |
| Duration of short-circuit current at (or below) 25°C (see Note 3) | unlimited                    |
| Continuous total dissipation                                      | See Dissipation Rating Table |
| Operating free-air temperature range, $T_A$ : Q suffix            | -40°C to 125°C               |
| Storage temperature range, $T_{stg}$                              | -65°C to 150°C               |
| Lead temperature 1,6 mm (1/16 inch) from case for 10 seconds      | 260°C                        |

† Stresses beyond those listed under “absolute maximum ratings” may cause permanent damage to the device. These are stress ratings only, and functional operation of the device at these or any other conditions beyond those indicated under “recommended operating conditions” is not implied. Exposure to absolute-maximum-rated conditions for extended periods may affect device reliability.

- NOTES: 1. All voltage values, except differential voltages, are with respect to the midpoint between  $V_{DD+}$  and  $V_{DD-}$ .  
 2. Differential voltages are at  $IN+$  with respect to  $IN-$ . Excessive current flows when input is brought below  $V_{DD-} - 0.3$  V.  
 3. The output may be shorted to either supply. Temperature and/or supply voltages must be limited to ensure that the maximum dissipation rating is not exceeded.

**DISSIPATION RATING TABLE**

| PACKAGE | $T_A \leq 25^\circ\text{C}$<br>POWER RATING | DERATING FACTOR<br>ABOVE $T_A = 25^\circ\text{C}$ | $T_A = 70^\circ\text{C}$<br>POWER RATING | $T_A = 85^\circ\text{C}$<br>POWER RATING | $T_A = 125^\circ\text{C}$<br>POWER RATING |
|---------|---|---|--|--|---|
| D-8     | 724 mW                                      | 5.8 mW/°C   | 464 mW                                   | 377 mW                                   | 144 mW                                    |
| D-14    | 950 mW                                      | 7.6 mW/°C   | 608 mW                                   | 450 mW                                   | 190 mW                                    |
| PW-8    | 525 mW                                      | 4.2 mW/°C   | 336 mW                                   | 273 mW                                   | 105 mW                                    |
| PW-14   | 700 mW                                      | 5.6 mW/°C   | 448 mW                                   | 364 mW                                   | 140 mW                                    |

**recommended operating conditions**

|                                       | MIN       | MAX             | UNIT |
|---------------------------------------|-----------|-----------------|------|
| Supply voltage, $V_{DD\pm}$           | $\pm 2.2$ | $\pm 8$         | V    |
| Input voltage range, $V_I$            | $V_{DD-}$ | $V_{DD+} - 1.5$ | V    |
| Common-mode input voltage, $V_{IC}$   | $V_{DD-}$ | $V_{DD+} - 1.5$ | V    |
| Operating free-air temperature, $T_A$ | -40       | 125             | °C   |

‡ Referenced to 2.5 V



**TLC225x-Q1, TLC225xA-Q1**  
**Advanced LinCMOS™ RAIL-TO-RAIL**  
**VERY LOW-POWER OPERATIONAL AMPLIFIERS**

SGLS188B – OCTOBER 2003 – REVISED APRIL 2008

**electrical characteristics at specified free-air temperature,  $V_{DD} = 5\text{ V}$  (unless otherwise noted)**

| PARAMETER  | TEST CONDITIONS   | $T_A$ †                      | TLC2252-Q1 |             |     | TLC2252A-Q1 |             |               | UNIT                         |
|--|---|------------------------------|------------|-------------|-----|-------------|-------------|---------------|------------------------------|
|  |   |                              | MIN        | TYP         | MAX | MIN         | TYP         | MAX           |                              |
| $V_{IO}$ Input offset voltage  |   | 25°C                         | 200        | 1500        |     | 200         | 850         | $\mu\text{V}$ |                              |
|  |   | Full range                   |            | 1750        |     | 1000        |             |               |                              |
| $\alpha_{VIO}$ Temperature coefficient of input offset voltage             |   | 25°C to 125°C                | 0.5        |             |     | 0.5         |             |               | $\mu\text{V}/^\circ\text{C}$ |
| Input offset voltage long-term drift (see Note 4)                          | $V_{DD\pm} = \pm 2.5\text{ V}$ ,<br>$V_O = 0$ ,<br>$V_{IC} = 0$ ,<br>$R_S = 50\ \Omega$ | 25°C                         | 0.003      |             |     | 0.003       |             |               | $\mu\text{V}/\text{mo}$      |
| $I_{IO}$ Input offset current  |   | 25°C                         | 0.5        | 60          |     | 0.5         | 60          | pA            |                              |
|  |   | Full range                   |            | 1000        |     | 1000        |             |               |                              |
| $I_{IB}$ Input bias current  |   | 25°C                         | 1          | 60          |     | 1           | 60          | pA            |                              |
|  |   | Full range                   |            | 1000        |     | 1000        |             |               |                              |
| $V_{ICR}$ Common-mode input voltage range                                  | $R_S = 50\ \Omega$ ,<br>$ V_{IO}  \leq 5\text{ mV}$                                     | 25°C                         | 0 to 4     | -0.3 to 4.2 |     | 0 to 4      | -0.3 to 4.2 | V             |                              |
|  |   | Full range                   | 0 to 3.5   |             |     | 0 to 3.5    |             |               |                              |
| $V_{OH}$ High-level output voltage   | $I_{OH} = -20\ \mu\text{A}$   | 25°C                         | 4.98       |             |     | 4.98        |             |               | V                            |
|  | $I_{OH} = -75\ \mu\text{A}$   | 25°C                         | 4.9        | 4.94        |     | 4.9         | 4.94        |               |                              |
|  | Full range  |                              | 4.8        |             |     | 4.8         |             |               |                              |
| $V_{OL}$ Low-level output voltage  | $V_{IC} = 2.5\text{ V}$ ,<br>$I_{OL} = 50\ \mu\text{A}$                                 | 25°C                         | 0.01       |             |     | 0.01        |             |               | V                            |
|  | $V_{IC} = 2.5\text{ V}$ ,<br>$I_{OL} = 500\ \mu\text{A}$                                | 25°C                         | 0.09       | 0.15        |     | 0.09        | 0.15        |               |                              |
|  |   | Full range                   |            | 0.15        |     | 0.15        |             |               |                              |
|  | $V_{IC} = 2.5\text{ V}$ ,<br>$I_{OL} = 4\text{ mA}$                                     | 25°C                         | 0.8        | 1           |     | 0.7         | 1           |               |                              |
| Full range   |   |                              | 1.2        |             | 1.2 |             |             |               |                              |
| $A_{VD}$ Large-signal differential voltage amplification                   | $V_{IC} = 2.5\text{ V}$ ,<br>$V_O = 1\text{ V to }4\text{ V}$                           | $R_L = 100\text{ k}\Omega$ ‡ | 25°C       | 100         | 350 |             | 100         | 350           | V/mV                         |
|  |   | $R_L = 1\text{ M}\Omega$ ‡   | Full range |             | 10  |             | 10          |               |                              |
|  |   |                              | 25°C       | 1700        |     |             | 1700        |               |                              |
| $r_{id}$ Differential input resistance                                     |   | 25°C                         | $10^{12}$  |             |     | $10^{12}$   |             |               | $\Omega$                     |
| $r_{ic}$ Common-mode input resistance                                      |   | 25°C                         | $10^{12}$  |             |     | $10^{12}$   |             |               | $\Omega$                     |
| $c_{ic}$ Common-mode input capacitance                                     | $f = 10\text{ kHz}$ ,<br>$f = 10\text{ kHz}$ ,  | 25°C                         | 8          |             |     | 8           |             |               | pF                           |
| $z_o$ Closed-loop output impedance   | $f = 25\text{ kHz}$ ,<br>$A_V = 10$   | 25°C                         | 200        |             |     | 200         |             |               | $\Omega$                     |
| CMRR Common-mode rejection ratio   | $V_{IC} = 0\text{ to }2.7\text{ V}$ ,<br>$V_O = 2.5\text{ V}$ ,<br>$R_S = 50\ \Omega$   | 25°C                         | 70         | 83          |     | 70          | 83          | dB            |                              |
|  |   | Full range                   |            | 70          |     | 70          |             |               |                              |
| $k_{SVR}$ Supply-voltage rejection ratio ( $\Delta V_{DD}/\Delta V_{IO}$ ) | $V_{DD} = 4.4\text{ V to }16\text{ V}$ ,<br>$V_{IC} = V_{DD}/2$ ,<br>No load            | 25°C                         | 80         | 95          |     | 80          | 95          | dB            |                              |
|  |   | Full range                   |            | 80          |     | 80          |             |               |                              |
| $I_{DD}$ Supply current  | $V_O = 2.5\text{ V}$ ,<br>No load   | 25°C                         | 70         | 125         |     | 70          | 125         | $\mu\text{A}$ |                              |
|  |   | Full range                   |            | 150         |     | 150         |             |               |                              |

† Full range is  $-40^\circ\text{C}$  to  $125^\circ\text{C}$  for Q suffix.

‡ Referenced to 2.5 V

NOTE 4: Typical values are based on the input offset voltage shift observed through 500 hours of operating life test at  $T_A = 150^\circ\text{C}$  extrapolated to  $T_A = 25^\circ\text{C}$  using the Arrhenius equation and assuming an activation energy of 0.96 eV.



**TLC225x-Q1, TLC225xA-Q1**  
**Advanced LinCMOS™ RAIL-TO-RAIL**  
**VERY LOW-POWER OPERATIONAL AMPLIFIERS**

SGLS188B – OCTOBER 2003 – REVISED APRIL 2008

**operating characteristics at specified free-air temperature,  $V_{DD} = 5\text{ V}$**

| PARAMETER   | TEST CONDITIONS   | $T_A^\dagger$ | TLC2252-Q1 |      |     | TLC2252A-Q1 |      |     | UNIT                   |
|-------------|---|---------------|------------|------|-----|-------------|------|-----|------------------------|
|             |   |               | MIN        | TYP  | MAX | MIN         | TYP  | MAX |                        |
| SR          | Slew rate at unity gain<br>$V_O = 0.5\text{ V to }3.5\text{ V}$ ,<br>$R_L = 100\text{ k}\Omega^\ddagger$ , $C_L = 100\text{ pF}^\ddagger$     | 25°C          | 0.07       | 0.12 |     | 0.07        | 0.12 |     | V/ $\mu\text{s}$       |
|             |   | Full range    | 0.05       |      |     | 0.05        |      |     |                        |
| $V_n$       | Equivalent input noise voltage<br>$f = 10\text{ Hz}$<br>$f = 1\text{ kHz}$  | 25°C          |            | 36   |     |             | 36   |     | nV/ $\sqrt{\text{Hz}}$ |
|             |   | 25°C          |            | 19   |     |             | 19   |     |                        |
| $V_{N(PP)}$ | Peak-to-peak equivalent input noise voltage<br>$f = 0.1\text{ Hz to }1\text{ Hz}$<br>$f = 0.1\text{ Hz to }10\text{ Hz}$                      | 25°C          |            | 0.7  |     |             | 0.7  |     | $\mu\text{V}$          |
|             |   | 25°C          |            | 1.1  |     |             | 1.1  |     |                        |
| $I_n$       | Equivalent input noise current  | 25°C          |            | 0.6  |     |             | 0.6  |     | fA/ $\sqrt{\text{Hz}}$ |
| THD + N     | Total harmonic distortion plus noise<br>$V_O = 0.5\text{ V to }2.5\text{ V}$ ,<br>$f = 10\text{ kHz}$ ,<br>$R_L = 50\text{ k}\Omega^\ddagger$ | 25°C          | $A_V = 1$  |      |     | 0.2%        |      |     |                        |
|             |   |               | $A_V = 10$ |      |     | 1%          |      |     |                        |
|             | Gain-bandwidth product<br>$f = 50\text{ kHz}$ ,<br>$C_L = 100\text{ pF}^\ddagger$   | 25°C          |            | 0.2  |     |             | 0.2  |     | MHz                    |
| $B_{OM}$    | Maximum output-swing bandwidth<br>$V_{O(PP)} = 2\text{ V}$ ,<br>$R_L = 50\text{ k}\Omega^\ddagger$  | 25°C          |            | 30   |     |             | 30   |     | kHz                    |
| $\phi_m$    | Phase margin at unity gain<br>$R_L = 50\text{ k}\Omega^\ddagger$ , $C_L = 100\text{ pF}^\ddagger$   | 25°C          |            | 63°  |     |             | 63°  |     |                        |
|             |   | 25°C          |            | 15   |     |             | 15   |     | dB                     |

$^\dagger$  Full range is  $-40^\circ\text{C}$  to  $125^\circ\text{C}$  for Q suffix.

$^\ddagger$  Referenced to 2.5 V



**TLC225x-Q1, TLC225xA-Q1**  
**Advanced LinCMOS™ RAIL-TO-RAIL**  
**VERY LOW-POWER OPERATIONAL AMPLIFIERS**

SGLS188B – OCTOBER 2003 – REVISED APRIL 2008

**electrical characteristics at specified free-air temperature,  $V_{DD\pm} = \pm 5$  V (unless otherwise noted)**

| PARAMETER   | TEST CONDITIONS   | $T_A$ †         | TLC2252-Q1             |             |           | TLC2252A-Q1 |       |     | UNIT       |     |
|---|---|-----------------|------------------------|-------------|-----------|-------------|-------|-----|------------|-----|
|   |   |                 | MIN                    | TYP         | MAX       | MIN         | TYP   | MAX |            |     |
| $V_{IO}$ Input offset voltage   | $V_{IC} = 0, V_O = 0, R_S = 50 \Omega$                          | 25°C            | 200                    |             | 1500      | 200         |       | 850 | $\mu$ V    |     |
|   |   | Full range      | 1750                   |             |           | 1000        |       |     |            |     |
| $\alpha_{VIO}$ Temperature coefficient of input offset voltage                  |   | 25°C to 125°C   | 0.5                    |             |           | 0.5         |       |     | $\mu$ V/°C |     |
| Input offset voltage long-term drift (see Note 4)                               |   | 25°C            | 0.003                  |             |           | 0.003       |       |     | $\mu$ V/mo |     |
| $I_{IO}$ Input offset current   |   | 25°C            | 0.5                    | 60          |           | 0.5         | 60    |     | pA         |     |
|   |   | Full range      | 1000                   |             |           | 1000        |       |     |            |     |
| $I_{IB}$ Input bias current   | 25°C  | 1               | 60                     |             | 1         | 60          |       | pA  |            |     |
|   | Full range  | 1000            |                        |             | 1000      |             |       |     |            |     |
| $V_{ICR}$ Common-mode input voltage range                                       | $R_S = 50 \Omega,  V_{IO}  \leq 5$ mV                           | 25°C            | -5 to 4                | -5.3 to 4.2 | -5 to 4   | -5.3 to 4.2 |       |     | V          |     |
|   |   | Full range      | -5 to 3.5              | -5 to 3.5   | -5 to 3.5 | -5 to 3.5   |       |     |            |     |
| $V_{OM+}$ Maximum positive peak output voltage                                  | $I_O = -20 \mu$ A   | 25°C            | 4.98                   |             | 4.98      |             |       |     | V          |     |
|   |   | 25°C            | 4.9                    | 4.93        |           | 4.9         | 4.93  |     |            |     |
|   |   | Full range      | 4.7                    |             |           | 4.7         |       |     |            |     |
|   |   | 25°C            | 4.8                    | 4.86        |           | 4.8         | 4.86  |     |            |     |
| $V_{OM-}$ Maximum negative peak output voltage                                  | $V_{IC} = 0, I_O = 50 \mu$ A                                    | 25°C            | -4.99                  |             | -4.99     |             |       |     | V          |     |
|   |   | 25°C            | -4.85                  | -4.91       |           | -4.85       | -4.91 |     |            |     |
|   | Full range  | -4.85           |                        |             | -4.85     |             |       |     |            |     |
|   | $V_{IC} = 0, I_O = 4$ mA  | 25°C            | -4                     | -4.3        |           | -4          | -4.3  |     |            |     |
|   |   | Full range      | -3.8                   |             |           | -3.8        |       |     |            |     |
|   | $A_{VD}$ Large-signal differential voltage amplification        | $V_O = \pm 4$ V | $R_L = 100$ k $\Omega$ | 25°C        | 40        | 150         |       | 40  |            | 150 |
| Full range  |   |                 |                        | 10          |           |             | 10    |     |            |     |
| $R_L = 1$ M $\Omega$  |   |                 | 25°C                   | 3000        |           |             | 3000  |     |            |     |
| $r_{id}$ Differential input resistance  |   | 25°C            | $10^{12}$              |             |           | $10^{12}$   |       |     | $\Omega$   |     |
| $r_{ic}$ Common-mode input resistance   |   | 25°C            | $10^{12}$              |             |           | $10^{12}$   |       |     | $\Omega$   |     |
| $c_{ic}$ Common-mode input capacitance  | f = 10 kHz, P package   | 25°C            | 8                      |             |           | 8           |       |     | pF         |     |
| $z_o$ Closed-loop output impedance  | f = 25 kHz, $A_V = 10$  | 25°C            | 190                    |             |           | 190         |       |     | $\Omega$   |     |
| CMRR Common-mode rejection ratio  | $V_{IC} = -5$ V to 2.7 V, $V_O = 0, R_S = 50 \Omega$            | 25°C            | 75                     | 88          |           | 75          | 88    |     | dB         |     |
|   |   | Full range      | 75                     |             |           | 75          |       |     |            |     |
| $k_{SVR}$ Supply-voltage rejection ratio ( $\Delta V_{DD\pm} / \Delta V_{IO}$ ) | $V_{DD} = \pm 2.2$ V to $\pm 8$ V, $V_{IC} = 0, \text{No load}$ | 25°C            | 80                     | 95          |           | 80          | 95    |     | dB         |     |
|   |   | Full range      | 80                     |             |           | 80          |       |     |            |     |
| $I_{DD}$ Supply current   | $V_O = 2.5$ V, No load  | 25°C            | 80                     | 125         |           | 80          | 125   |     | $\mu$ A    |     |
|   |   | Full range      | 150                    |             |           | 150         |       |     |            |     |

† Full range is -40°C to 125°C for Q suffix.

NOTE 4: Typical values are based on the input offset voltage shift observed through 500 hours of operating life test at  $T_A = 150^\circ$ C extrapolated to  $T_A = 25^\circ$ C using the Arrhenius equation and assuming an activation energy of 0.96 eV.



**TLC225x-Q1, TLC225xA-Q1**  
**Advanced LinCMOS™ RAIL-TO-RAIL**  
**VERY LOW-POWER OPERATIONAL AMPLIFIERS**

SGLS188B – OCTOBER 2003 – REVISED APRIL 2008

operating characteristics at specified free-air temperature,  $V_{DD\pm} = \pm 5\text{ V}$

| PARAMETER   | TEST CONDITIONS  | $T_A^\dagger$       | TLC2252-Q1 |      |     | TLC2252A-Q1 |      |     | UNIT                   |
|-------------|--|---------------------|------------|------|-----|-------------|------|-----|------------------------|
|             |  |                     | MIN        | TYP  | MAX | MIN         | TYP  | MAX |                        |
| SR          | Slew rate at unity gain<br>$V_O = \pm 2\text{ V}$ ,<br>$C_L = 100\text{ pF}$ ,<br>$R_L = 100\text{ k}\Omega$           | 25°C                | 0.07       | 0.12 |     | 0.07        | 0.12 |     | V/ $\mu\text{s}$       |
|             |  | Full range          | 0.05       |      |     | 0.05        |      |     |                        |
| $V_n$       | Equivalent input noise voltage   | f = 10 Hz           | 25°C       |      |     | 38          |      |     | nV/ $\sqrt{\text{Hz}}$ |
|             |  | f = 1 kHz           | 25°C       |      |     | 19          |      |     |                        |
| $V_{N(PP)}$ | Peak-to-peak equivalent input noise voltage  | f = 0.1 Hz to 1 Hz  | 25°C       |      |     | 0.8         |      |     | $\mu\text{V}$          |
|             |  | f = 0.1 Hz to 10 Hz | 25°C       |      |     | 1.1         |      |     |                        |
| $I_n$       | Equivalent input noise current   | 25°C                | 0.6        |      |     | 0.6         |      |     | fA/ $\sqrt{\text{Hz}}$ |
| THD + N     | Total harmonic distortion plus noise<br>$V_O = \pm 2.3\text{ V}$ ,<br>$R_L = 50\text{ k}\Omega$ ,<br>f = 10 kHz        | $A_V = 1$           | 25°C       |      |     | 0.2%        |      |     |                        |
|             |  | $A_V = 10$          | 25°C       |      |     | 1%          |      |     |                        |
|             | Gain-bandwidth product<br>f = 10 kHz,<br>$C_L = 100\text{ pF}$ ,<br>$R_L = 50\text{ k}\Omega$                          | 25°C                | 0.21       |      |     | 0.21        |      |     | MHz                    |
| BOM         | Maximum output-swing bandwidth<br>$V_{O(PP)} = 4.6\text{ V}$ ,<br>$R_L = 50\text{ k}\Omega$ ,<br>$C_L = 100\text{ pF}$ | 25°C                | 14         |      |     | 14          |      |     | kHz                    |
| $\phi_m$    | Phase margin at unity gain<br>$R_L = 50\text{ k}\Omega$ ,<br>$C_L = 100\text{ pF}$                                     | 25°C                | 63°        |      |     | 63°         |      |     |                        |
|             |  | 25°C                | 15         |      |     | 15          |      |     | dB                     |

† Full range is -40°C to 125°C for Q suffix.



**TLC225x-Q1, TLC225xA-Q1**  
**Advanced LinCMOS™ RAIL-TO-RAIL**  
**VERY LOW-POWER OPERATIONAL AMPLIFIERS**

SGLS188B – OCTOBER 2003 – REVISED APRIL 2008

**electrical characteristics at specified free-air temperature,  $V_{DD} = 5\text{ V}$  (unless otherwise noted)**

| PARAMETER  | TEST CONDITIONS   | $T_A^\dagger$                       | TLC2254-Q1 |             |      | TLC2254A-Q1 |             |             | UNIT                         |
|--|---|-------------------------------------|------------|-------------|------|-------------|-------------|-------------|------------------------------|
|  |   |                                     | MIN        | TYP         | MAX  | MIN         | TYP         | MAX         |                              |
| $V_{IO}$ Input offset voltage  |   | 25°C                                |            | 200         | 1500 |             | 200         | 850         | $\mu\text{V}$                |
|  |   | Full range                          |            |             | 1750 |             |             | 1000        |                              |
| $\alpha_{VIO}$ Temperature coefficient of input offset voltage             | $V_{DD\pm} = \pm 2.5\text{ V}$ ,<br>$V_{IC} = 0$ ,<br>$V_O = 0$ ,<br>$R_S = 50\ \Omega$ | 25°C to 125°C                       |            | 0.5         |      |             | 0.5         |             | $\mu\text{V}/^\circ\text{C}$ |
| Input offset voltage long-term drift (see Note 4)                          |   | 25°C                                |            | 0.003       |      |             | 0.003       |             | $\mu\text{V}/\text{mo}$      |
| $I_{IO}$ Input offset current  |   | 25°C                                |            | 0.5         | 60   |             | 0.5         | 60          | $\text{pA}$                  |
|  |   | 125°C                               |            |             | 1000 |             |             | 1000        |                              |
| $I_{IB}$ Input bias current  | 25°C  |                                     | 1          | 60          |      | 1           | 60          | $\text{pA}$ |                              |
|  | 125°C   |                                     |            | 1000        |      |             | 1000        |             |                              |
| $V_{ICR}$ Common-mode input voltage range                                  | $R_S = 50\ \Omega$ ,<br>$ V_{IO}  \leq 5\text{ mV}$                                     | 25°C                                | 0 to 4     | -0.3 to 4.2 |      | 0 to 4      | -0.3 to 4.2 | $\text{V}$  |                              |
|  |   | Full range                          | 0 to 3.5   |             |      | 0 to 3.5    |             |             |                              |
| $V_{OH}$ High-level output voltage   | $I_{OH} = -20\ \mu\text{A}$   | 25°C                                |            | 4.98        |      |             | 4.98        | $\text{V}$  |                              |
|  | $I_{OH} = -75\ \mu\text{A}$   | 25°C                                | 4.9        | 4.94        |      | 4.9         | 4.94        |             |                              |
|  | Full range  |                                     | 4.8        |             |      | 4.8         |             |             |                              |
| $V_{OL}$ Low-level output voltage  | $V_{IC} = 2.5\text{ V}$ ,<br>$I_{OL} = 50\ \mu\text{A}$                                 | 25°C                                |            | 0.01        |      |             | 0.01        | $\text{V}$  |                              |
|  | $V_{IC} = 2.5\text{ V}$ ,<br>$I_{OL} = 500\ \mu\text{A}$                                | 25°C                                |            | 0.09        | 0.15 |             | 0.09        |             | 0.15                         |
|  | Full range  |                                     |            | 0.15        |      |             | 0.15        |             |                              |
|  | $V_{IC} = 2.5\text{ V}$ ,<br>$I_{OL} = 4\text{ mA}$                                     | 25°C                                |            | 0.8         | 1    |             | 0.7         |             | 1                            |
|  | Full range  |                                     |            | 1.2         |      |             | 1.2         |             |                              |
| $A_{VD}$ Large-signal differential voltage amplification                   | $V_{IC} = 2.5\text{ V}$ ,<br>$V_O = 1\text{ V to }4\text{ V}$                           | $R_L = 100\text{ k}\Omega^\ddagger$ | 25°C       | 100         | 350  |             | 100         | 350         | $\text{V/mV}$                |
|  |   |                                     | Full range |             | 10   |             |             | 10          |                              |
|  |   | $R_L = 1\text{ M}\Omega^\ddagger$   | 25°C       |             | 1700 |             |             | 1700        |                              |
| $r_{i(d)}$ Differential input resistance                                   |   | 25°C                                |            | $10^{12}$   |      |             | $10^{12}$   | $\Omega$    |                              |
| $r_{i(c)}$ Common-mode input resistance                                    |   | 25°C                                |            | $10^{12}$   |      |             | $10^{12}$   | $\Omega$    |                              |
| $C_{i(c)}$ Common-mode input capacitance                                   | $f = 10\text{ kHz}$ ,<br>N package  | 25°C                                |            | 8           |      |             | 8           | $\text{pF}$ |                              |
| $z_o$ Closed-loop output impedance   | $f = 25\text{ kHz}$ ,<br>$A_V = 10$   | 25°C                                |            | 200         |      |             | 200         | $\Omega$    |                              |
| CMRR Common-mode rejection ratio   | $V_{IC} = 0\text{ to }2.7\text{ V}$ ,<br>$V_O = 2.5\text{ V}$ ,<br>$R_S = 50\ \Omega$   | 25°C                                | 70         | 83          |      | 70          | 83          | $\text{dB}$ |                              |
|  |   | Full range                          |            | 70          |      |             | 70          |             |                              |
| $k_{SVR}$ Supply-voltage rejection ratio ( $\Delta V_{DD}/\Delta V_{IO}$ ) | $V_{DD} = 4.4\text{ V to }16\text{ V}$ ,<br>$V_{IC} = V_{DD}/2$ ,<br>No load            | 25°C                                | 80         | 95          |      | 80          | 95          | $\text{dB}$ |                              |
|  |   | Full range                          |            | 80          |      |             | 80          |             |                              |
| $I_{DD}$ Supply current (four amplifiers)                                  | $V_O = 2.5\text{ V}$ ,<br>No load   | 25°C                                |            | 140         | 250  |             | 140         | 250         | $\mu\text{A}$                |
|  |   | Full range                          |            |             | 300  |             |             | 300         |                              |

$^\dagger$  Full range is  $-40^\circ\text{C}$  to  $125^\circ\text{C}$  for Q suffix.

$^\ddagger$  Referenced to 2.5 V

NOTE 4: Typical values are based on the input offset voltage shift observed through 500 hours of operating life test at  $T_A = 150^\circ\text{C}$  extrapolated to  $T_A = 25^\circ\text{C}$  using the Arrhenius equation and assuming an activation energy of 0.96 eV.



**TLC225x-Q1, TLC225xA-Q1**  
**Advanced LinCMOS™ RAIL-TO-RAIL**  
**VERY LOW-POWER OPERATIONAL AMPLIFIERS**

SGLS188B – OCTOBER 2003 – REVISED APRIL 2008

operating characteristics at specified free-air temperature,  $V_{DD} = 5\text{ V}$

| PARAMETER   | TEST CONDITIONS   | $T_A^\dagger$   | TLC2254-Q1 |      |     | TLC2254A-Q1 |      |     | UNIT                   |
|-------------|---|---|------------|------|-----|-------------|------|-----|------------------------|
|             |   |   | MIN        | TYP  | MAX | MIN         | TYP  | MAX |                        |
| SR          | Slew rate at unity gain<br>$V_O = 0.5\text{ V to }3.5\text{ V}$ ,<br>$R_L = 100\text{ k}\Omega^\ddagger$ ,<br>$C_L = 100\text{ pF}^\ddagger$  | 25°C  | 0.07       | 0.12 |     | 0.07        | 0.12 |     | V/ $\mu$ s             |
|             |   | Full range  | 0.05       |      |     | 0.05        |      |     |                        |
| $V_n$       | Equivalent input noise voltage<br>$f = 10\text{ Hz}$<br>$f = 1\text{ kHz}$  | 25°C  | 36         |      |     | 36          |      |     | nV/ $\sqrt{\text{Hz}}$ |
|             |   | 25°C  | 19         |      |     | 19          |      |     |                        |
| $V_{N(PP)}$ | Peak-to-peak equivalent input noise voltage<br>$f = 0.1\text{ Hz to }1\text{ Hz}$<br>$f = 0.1\text{ Hz to }10\text{ Hz}$                      | 25°C  | 0.7        |      |     | 0.7         |      |     | $\mu$ V                |
|             |   | 25°C  | 1.1        |      |     | 1.1         |      |     |                        |
| $I_n$       | Equivalent input noise current  | 25°C  | 0.6        |      |     | 0.6         |      |     | fA/ $\sqrt{\text{Hz}}$ |
| THD + N     | Total harmonic distortion plus noise<br>$V_O = 0.5\text{ V to }2.5\text{ V}$ ,<br>$f = 20\text{ kHz}$ ,<br>$R_L = 50\text{ k}\Omega^\ddagger$ | 25°C  | $A_V = 1$  |      |     | 0.2%        |      |     |                        |
|             |   |   | $A_V = 10$ |      |     | 1%          |      |     |                        |
|             | Gain-bandwidth product<br>$f = 50\text{ kHz}$ ,<br>$C_L = 100\text{ pF}^\ddagger$   | $R_L = 50\text{ k}\Omega^\ddagger$ ,<br>25°C            | 0.2        |      |     | 0.2         |      |     | MHz                    |
| $B_{OM}$    | Maximum output-swing bandwidth<br>$V_{O(PP)} = 2\text{ V}$ ,<br>$R_L = 50\text{ k}\Omega^\ddagger$  | $A_V = 1$ ,<br>$C_L = 100\text{ pF}^\ddagger$ ,<br>25°C | 30         |      |     | 30          |      |     | kHz                    |
| $\phi_m$    | Phase margin at unity gain<br>$R_L = 50\text{ k}\Omega^\ddagger$  | $C_L = 100\text{ pF}^\ddagger$ ,<br>25°C                | 63°        |      |     | 63°         |      |     |                        |
|             |   |   | 15         |      |     | 15          |      |     | dB                     |

$^\dagger$  Full range is  $-40^\circ\text{C}$  to  $125^\circ\text{C}$  for Q suffix.

$^\ddagger$  Referenced to 2.5 V



**TLC225x-Q1, TLC225xA-Q1**  
**Advanced LinCMOS™ RAIL-TO-RAIL**  
**VERY LOW-POWER OPERATIONAL AMPLIFIERS**

SGLS188B – OCTOBER 2003 – REVISED APRIL 2008

**electrical characteristics at specified free-air temperature,  $V_{DD\pm} = \pm 5\text{ V}$  (unless otherwise noted)**

| PARAMETER   | TEST CONDITIONS   | $T_A^\dagger$               | TLC2254-Q1 |             |       | TLC2254A-Q1 |             |               | UNIT                         |
|---|---|-----------------------------|------------|-------------|-------|-------------|-------------|---------------|------------------------------|
|   |   |                             | MIN        | TYP         | MAX   | MIN         | TYP         | MAX           |                              |
| $V_{IO}$ Input offset voltage   | $V_{IC} = 0, V_O = 0, R_S = 50\ \Omega$   | 25°C                        | 200        |             | 1500  | 200         |             | 850           | $\mu\text{V}$                |
|   |   | Full range                  | 1750       |             |       | 1000        |             |               |                              |
| $\alpha_{VIO}$ Temperature coefficient of input offset voltage                |   | 25°C to 125°C               | 0.5        |             |       | 0.5         |             |               | $\mu\text{V}/^\circ\text{C}$ |
| Input offset voltage long-term drift (see Note 4)                             |   | 25°C                        | 0.003      |             |       | 0.003       |             |               | $\mu\text{V}/\text{mo}$      |
| $I_{IO}$ Input offset current   |   | 25°C                        | 0.5        | 60          |       | 0.5         | 60          |               | $\text{pA}$                  |
|   |   | 125°C                       | 1000       |             |       | 1000        |             |               |                              |
| $I_{IB}$ Input bias current   | 25°C  | 1                           | 60         |             | 1     | 60          |             | $\text{pA}$   |                              |
|   | 125°C   | 1000                        |            |             | 1000  |             |             |               |                              |
| $V_{ICR}$ Common-mode input voltage range                                     | $R_S = 50\ \Omega,  V_{IO}  \leq 5\ \text{mV}$  | 25°C                        | -5 to 4    | -5.3 to 4.2 |       | -5 to 4     | -5.3 to 4.2 | $\text{V}$    |                              |
|   |   | Full range                  | -5 to 3.5  |             |       | -5 to 3.5   |             |               |                              |
| $V_{OM+}$ Maximum positive peak output voltage                                | $I_O = -20\ \mu\text{A}$  | 25°C                        | 4.98       |             | 4.98  |             | $\text{V}$  |               |                              |
|   |   | 25°C                        | 4.9        | 4.93        |       | 4.9         |             | 4.93          |                              |
|   |   | Full range                  | 4.7        |             |       | 4.7         |             |               |                              |
|   |   | 25°C                        | 4.8        | 4.86        |       | 4.8         |             | 4.86          |                              |
| $V_{OM-}$ Maximum negative peak output voltage                                | $I_O = -200\ \mu\text{A}$   | 25°C                        | -4.99      |             | -4.99 |             | $\text{V}$  |               |                              |
|   |   | 25°C                        | -4.85      | -4.91       |       | -4.85       |             | -4.91         |                              |
|   |   | Full range                  | -4.85      |             |       | -4.85       |             |               |                              |
|   |   | 25°C                        | -4         | -4.3        |       | -4          |             | -4.3          |                              |
| $V_{IC} = 0, I_O = 50\ \mu\text{A}$   | $I_O = 500\ \mu\text{A}$  | 25°C                        | -4.99      |             | -4.99 |             | $\text{V}$  |               |                              |
|   |   | 25°C                        | -4.85      | -4.91       |       | -4.85       |             | -4.91         |                              |
| $V_{IC} = 0, I_O = 4\ \text{mA}$  | $I_O = 4\ \text{mA}$  | 25°C                        | -4         |             | -4.3  |             |             | $\text{V}$    |                              |
|   |   | Full range                  | -3.8       |             |       | -3.8        |             |               |                              |
| $A_{VD}$ Large-signal differential voltage amplification                      | $V_O = \pm 4\ \text{V}$   | $R_L = 100\ \text{k}\Omega$ | 25°C       | 40          | 150   |             | 40          | 150           | $\text{V}/\text{mV}$         |
|   |   |                             | Full range | 10          |       |             | 10          |               |                              |
|   |   | $R_L = 1\ \text{M}\Omega$   | 25°C       | 3000        |       |             | 3000        |               |                              |
| $r_{i(d)}$ Differential input resistance                                      |   | 25°C                        | $10^{12}$  |             |       | $10^{12}$   |             | $\Omega$      |                              |
| $r_{i(c)}$ Common-mode input resistance                                       |   | 25°C                        | $10^{12}$  |             |       | $10^{12}$   |             | $\Omega$      |                              |
| $c_{i(c)}$ Common-mode input capacitance                                      | $f = 10\ \text{kHz}, \text{ N package}$   | 25°C                        | 8          |             |       | 8           |             | $\text{pF}$   |                              |
| $z_o$ Closed-loop output impedance  | $f = 25\ \text{kHz}, A_V = 10$  | 25°C                        | 190        |             |       | 190         |             | $\Omega$      |                              |
| CMRR Common-mode rejection ratio  | $V_{IC} = -5\ \text{V to } 2.7\ \text{V}, V_O = 0, R_S = 50\ \Omega$                    | 25°C                        | 75         | 88          |       | 75          | 88          | $\text{dB}$   |                              |
|   |   | Full range                  | 75         |             |       | 75          |             |               |                              |
| $k_{SVR}$ Supply-voltage rejection ratio ( $\Delta V_{DD\pm}/\Delta V_{IO}$ ) | $V_{DD\pm} = \pm 2.2\ \text{V to } \pm 8\ \text{V}, V_{IC} = V_{DD}/2, \text{ No load}$ | 25°C                        | 80         | 95          |       | 80          | 95          | $\text{dB}$   |                              |
|   |   | Full range                  | 80         |             |       | 80          |             |               |                              |
| $I_{DD}$ Supply current (four amplifiers)                                     | $V_O = 0, \text{ No load}$  | 25°C                        | 160        | 250         |       | 160         | 250         | $\mu\text{A}$ |                              |
|   |   | Full range                  | 300        |             |       | 300         |             |               |                              |

$^\dagger$  Full range is  $-40^\circ\text{C}$  to  $125^\circ\text{C}$  for Q suffix.

NOTE 4: Typical values are based on the input offset voltage shift observed through 500 hours of operating life test at  $T_A = 150^\circ\text{C}$  extrapolated to  $T_A = 25^\circ\text{C}$  using the Arrhenius equation and assuming an activation energy of 0.96 eV.



**TLC225x-Q1, TLC225xA-Q1**  
**Advanced LinCMOS™ RAIL-TO-RAIL**  
**VERY LOW-POWER OPERATIONAL AMPLIFIERS**

SGLS188B – OCTOBER 2003 – REVISED APRIL 2008

**operating characteristics at specified free-air temperature,  $V_{DD\pm} = \pm 5\text{ V}$**

| PARAMETER   | TEST CONDITIONS                             |  | $T_A^\dagger$                        | TLC2254-Q1         |            |      | TLC2254A-Q1 |      |      | UNIT                   |                              |
|-------------|---|--|--------------------------------------|--------------------|------------|------|-------------|------|------|------------------------|------------------------------|
|             |   |  |                                      | MIN                | TYP        | MAX  | MIN         | TYP  | MAX  |                        |                              |
| SR          | Slew rate at unity gain                     | $V_O = \pm 2\text{ V}$ ,<br>$C_L = 100\text{ pF}$                                | $R_L = 100\text{ k}\Omega$           | 25°C               | 0.07       | 0.12 |             | 0.07 | 0.12 | $\text{V}/\mu\text{s}$ |                              |
|             |   |  |                                      | Full range         | 0.05       |      |             | 0.05 |      |                        |                              |
| $V_n$       | Equivalent input noise voltage              | $f = 10\text{ Hz}$   |                                      | 25°C               | 38         |      |             | 38   |      |                        | $\text{nV}/\sqrt{\text{Hz}}$ |
|             |   |  |                                      | $f = 1\text{ kHz}$ |            | 19   |             |      | 19   |                        |                              |
| $V_{N(PP)}$ | Peak-to-peak equivalent input noise voltage | $f = 0.1\text{ Hz to }1\text{ Hz}$   |                                      | 25°C               | 0.8        |      |             | 0.8  |      |                        | $\mu\text{V}$                |
|             |   | $f = 0.1\text{ Hz to }10\text{ Hz}$  |                                      | 1.1                |            |      | 1.1         |      |      |                        |                              |
| $I_n$       | Equivalent input noise current              |  |                                      | 25°C               | 0.6        |      |             | 0.6  |      |                        | $\text{fA}/\sqrt{\text{Hz}}$ |
| THD + N     | Total harmonic distortion plus noise        | $V_O = \pm 2.3\text{ V}$ ,<br>$R_L = 50\text{ k}\Omega$ ,<br>$f = 20\text{ kHz}$ | $A_V = 1$                            | 25°C               | 0.2%       |      |             | 0.2% |      |                        |                              |
|             |   |  |                                      |                    | $A_V = 10$ | 1%   |             |      | 1%   |                        |                              |
|             | Gain-bandwidth product                      | $f = 10\text{ kHz}$ ,<br>$C_L = 100\text{ pF}$                                   | $R_L = 50\text{ k}\Omega$            | 25°C               | 0.21       |      |             | 0.21 |      |                        | MHz                          |
| $B_{OM}$    | Maximum output-swing bandwidth              | $V_{O(PP)} = 4.6\text{ V}$ ,<br>$R_L = 50\text{ k}\Omega$                        | $A_V = 1$ ,<br>$C_L = 100\text{ pF}$ | 25°C               | 14         |      |             | 14   |      |                        | kHz                          |
| $\phi_m$    | Phase margin at unity gain                  | $R_L = 50\text{ k}\Omega$  | $C_L = 100\text{ pF}$                | 25°C               | 63°        |      |             | 63°  |      |                        |                              |
|             | Gain margin                                 |  |                                      | 25°C               | 15         |      |             | 15   |      |                        | dB                           |

† Full range is  $-40^\circ\text{C}$  to  $125^\circ\text{C}$  for Q suffix.



## TYPICAL CHARACTERISTICS

### Table of Graphs

|                 |   | FIGURE   |                  |
|-----------------|---|--|------------------|
| $V_{IO}$        | Input offset voltage                            | Distribution<br>vs Common-mode input voltage   | 2 – 5<br>6, 7    |
| $\alpha_{VIO}$  | Input offset voltage temperature coefficient    | Distribution                                   | 8 – 11           |
| $I_{IB}/I_{IO}$ | Input bias and input offset currents            | vs Free-air temperature                        | 12               |
| $V_I$           | Input voltage range                             | vs Supply voltage<br>vs Free-air temperature   | 13<br>14         |
| $V_{OH}$        | High-level output voltage                       | vs High-level output current                   | 15               |
| $V_{OL}$        | Low-level output voltage                        | vs Low-level output current                    | 16, 17           |
| $V_{OM+}$       | Maximum positive peak output voltage            | vs Output current                              | 18               |
| $V_{OM-}$       | Maximum negative peak output voltage            | vs Output current                              | 19               |
| $V_{O(PP)}$     | Maximum peak-to-peak output voltage             | vs Frequency                                   | 20               |
| $I_{OS}$        | Short-circuit output current                    | vs Supply voltage<br>vs Free-air temperature   | 21<br>22         |
| $V_O$           | Output voltage                                  | vs Differential input voltage                  | 23, 24           |
|                 | Differential gain                               | vs Load resistance                             | 25               |
| $A_{VD}$        | Large-signal differential voltage amplification | vs Frequency<br>vs Free-air temperature        | 26, 27<br>28, 29 |
| $z_o$           | Output impedance                                | vs Frequency                                   | 30, 31           |
| CMRR            | Common-mode rejection ratio                     | vs Frequency<br>vs Free-air temperature        | 32<br>33         |
| $k_{SVR}$       | Supply-voltage rejection ratio                  | vs Frequency<br>vs Free-air temperature        | 34, 35<br>36     |
| $I_{DD}$        | Supply current                                  | vs Supply voltage<br>vs Free-air temperature   | 37<br>38         |
| SR              | Slew rate                                       | vs Load capacitance<br>vs Free-air temperature | 39<br>40         |
| $V_O$           | Inverting large-signal pulse response           |  | 41, 42           |
| $V_O$           | Voltage-follower large-signal pulse response    |  | 43, 44           |
| $V_O$           | Inverting small-signal pulse response           |  | 45, 46           |
| $V_O$           | Voltage-follower small-signal pulse response    |  | 47, 48           |
| $V_n$           | Equivalent input noise voltage                  | vs Frequency                                   | 49, 50           |
|                 | Noise voltage (referred to input)               | Over a 10-second period                        | 51               |
|                 | Integrated noise voltage                        | vs Frequency                                   | 52               |
| THD + N         | Total harmonic distortion plus noise            | vs Frequency                                   | 53               |
|                 | Gain-bandwidth product                          | vs Free-air temperature<br>vs Supply voltage   | 54<br>55         |
| $\phi_m$        | Phase margin                                    | vs Frequency<br>vs Load capacitance            | 26, 27<br>56     |
| $A_m$           | Gain margin                                     | vs Load capacitance                            | 57               |
| $B_1$           | Unity-gain bandwidth                            | vs Load capacitance                            | 58               |
|                 | Overestimation of phase margin                  | vs Load capacitance                            | 59               |

**TLC225x-Q1, TLC225xA-Q1**  
**Advanced LinCMOS™ RAIL-TO-RAIL**  
**VERY LOW-POWER OPERATIONAL AMPLIFIERS**

SGLS188B – OCTOBER 2003 – REVISED APRIL 2008

**TYPICAL CHARACTERISTICS**

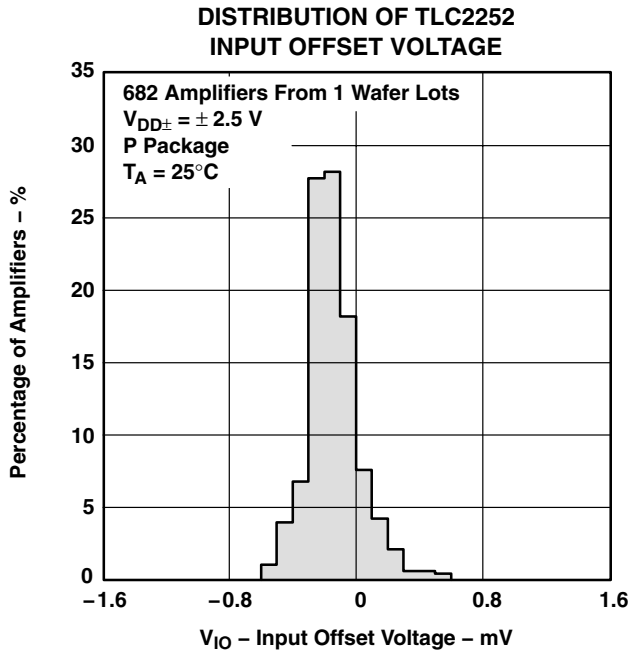

**Figure 2**

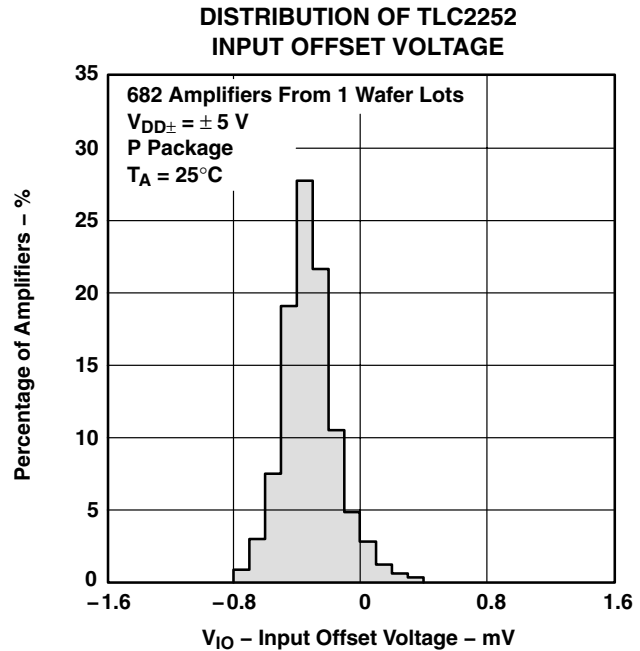

**Figure 3**

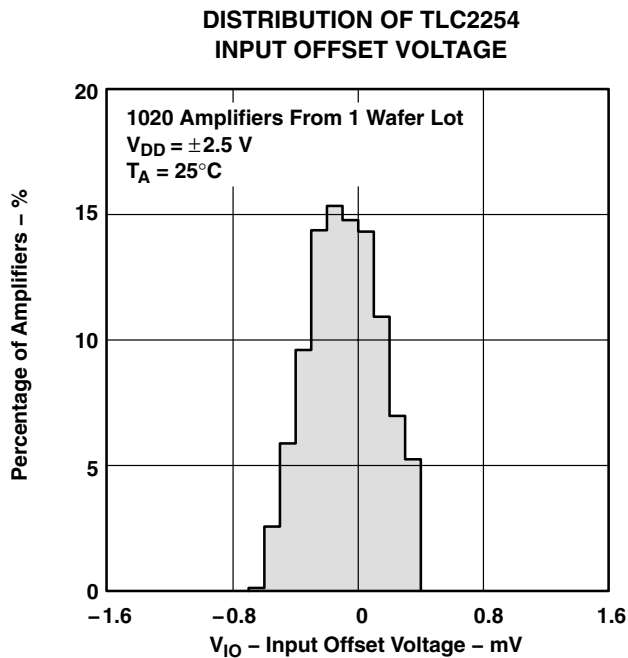

**Figure 4**

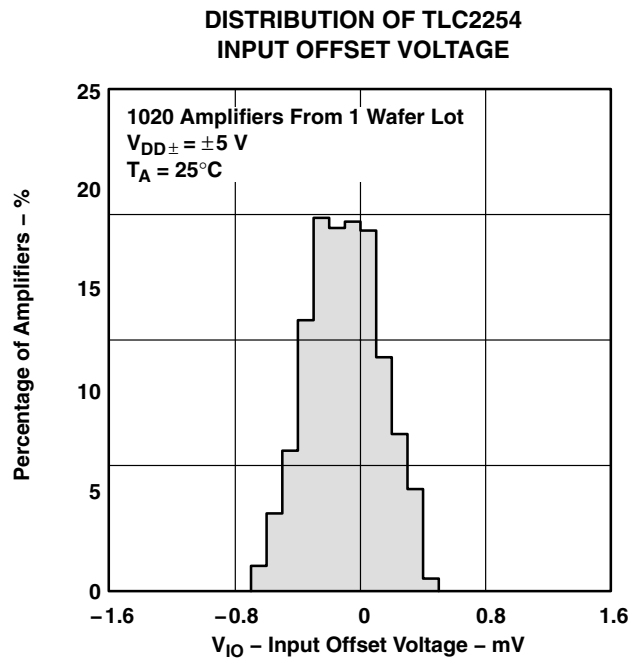

**Figure 5**



TYPICAL CHARACTERISTICS

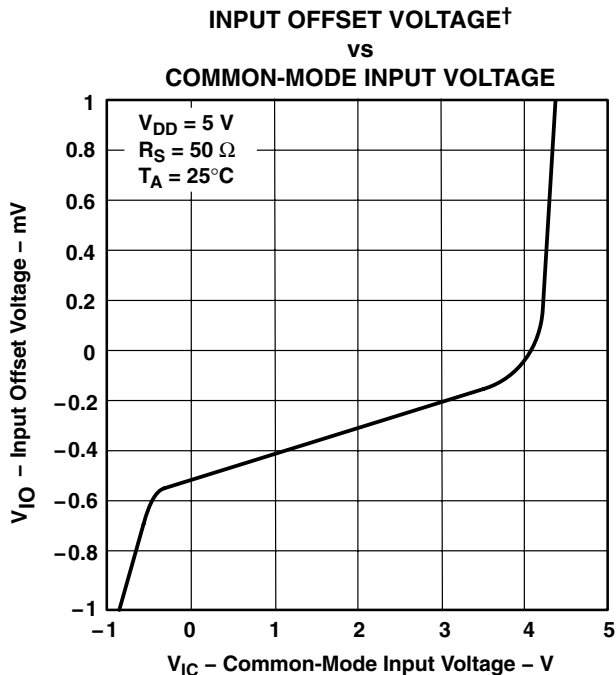

Figure 6

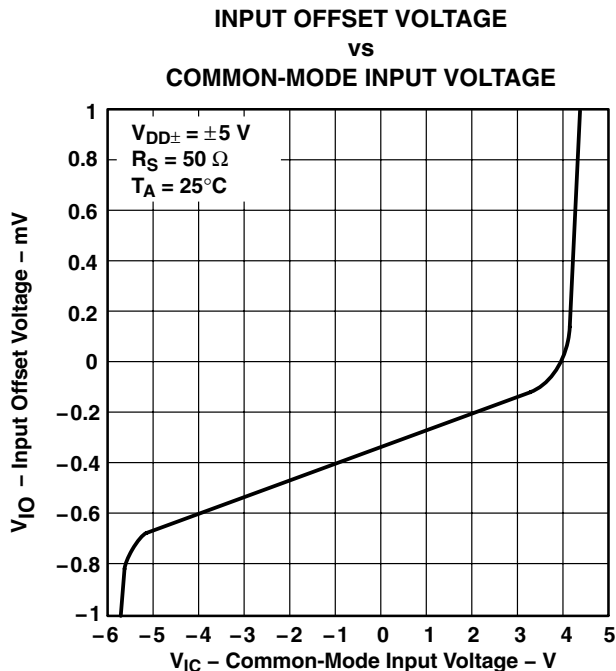

Figure 7

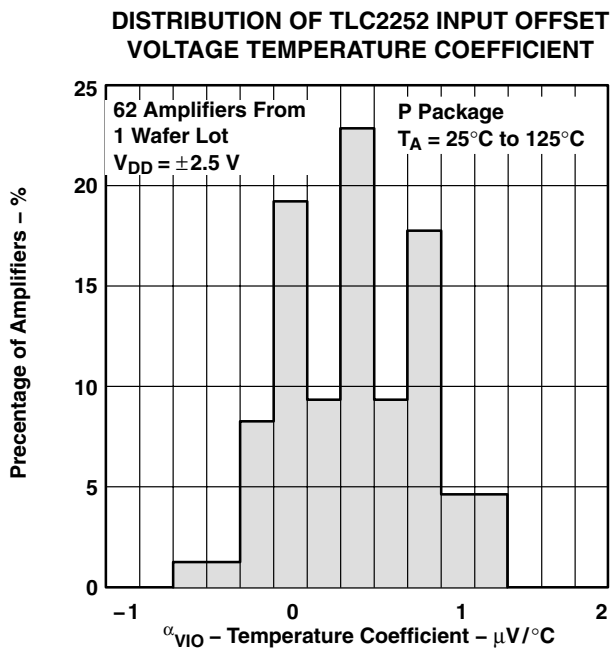

Figure 8

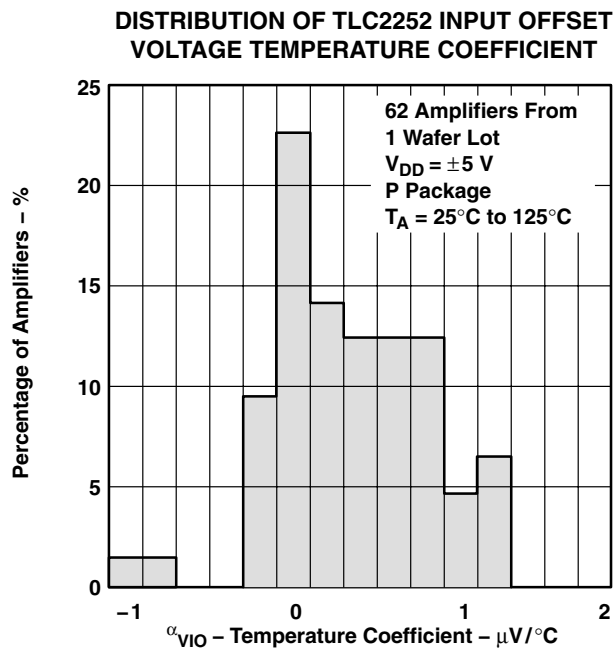

Figure 9

† For curves where  $V_{DD} = 5\text{ V}$ , all loads are referenced to 2.5 V.

**TLC225x-Q1, TLC225xA-Q1**  
**Advanced LinCMOS™ RAIL-TO-RAIL**  
**VERY LOW-POWER OPERATIONAL AMPLIFIERS**

SGLS188B – OCTOBER 2003 – REVISED APRIL 2008

**TYPICAL CHARACTERISTICS**

**DISTRIBUTION OF TLC2254 INPUT OFFSET VOLTAGE TEMPERATURE COEFFICIENT**

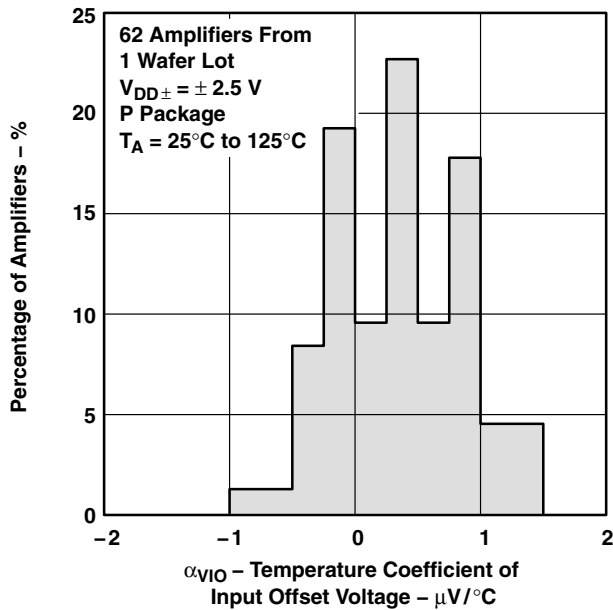

**Figure 10**

**DISTRIBUTION OF TLC2254 INPUT OFFSET VOLTAGE TEMPERATURE COEFFICIENT**

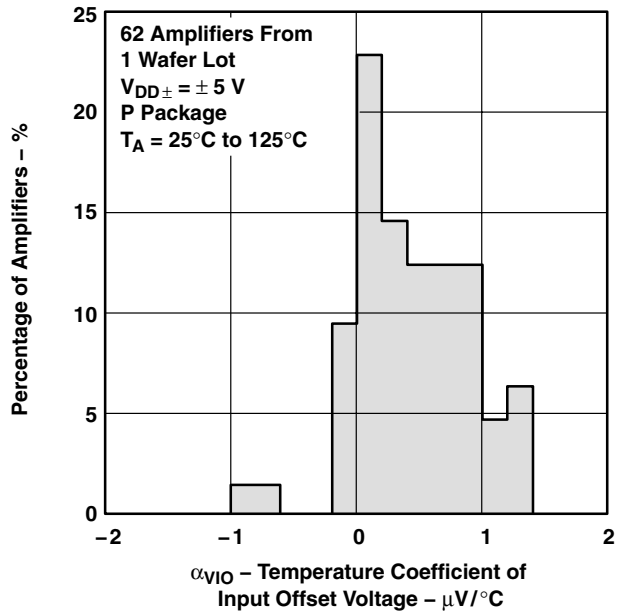

**Figure 11**

**INPUT BIAS AND INPUT OFFSET CURRENTS†**  
vs  
**FREE-AIR TEMPERATURE**

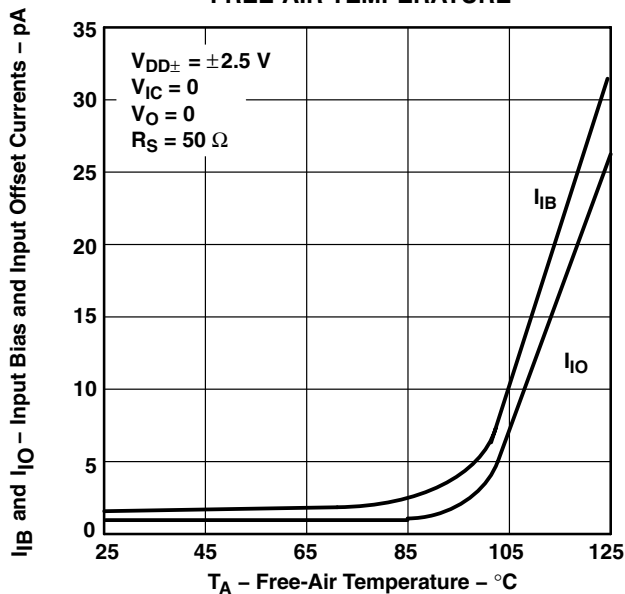

**Figure 12**

**INPUT VOLTAGE RANGE**  
vs  
**SUPPLY VOLTAGE**

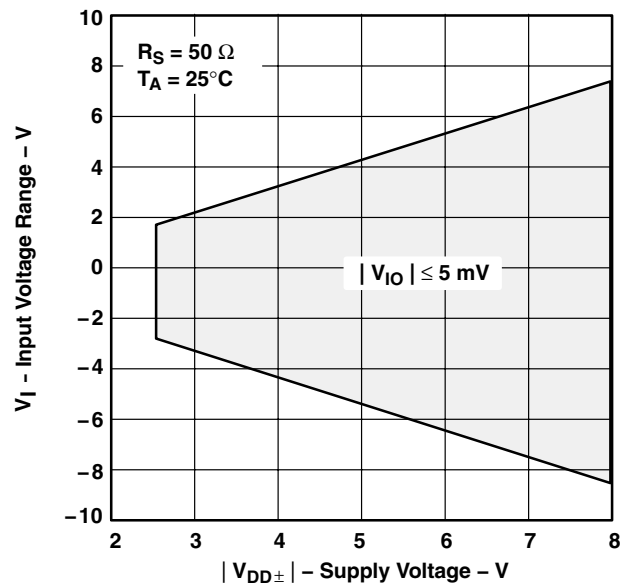
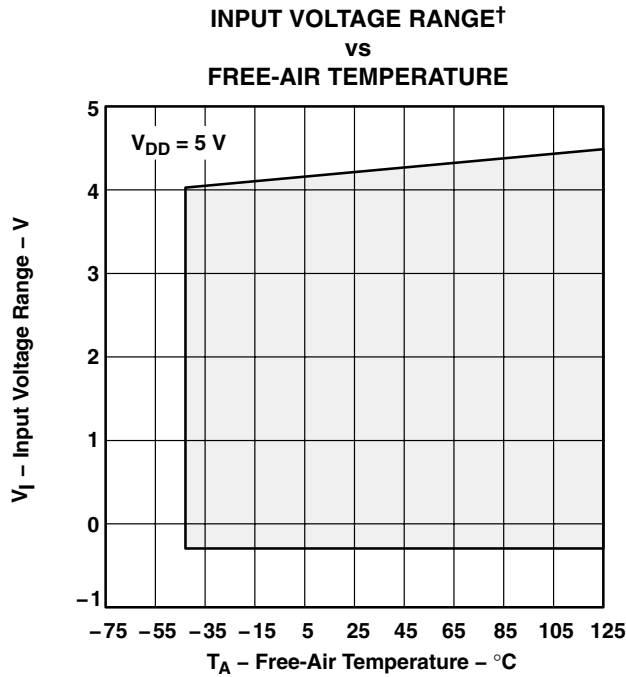

**Figure 13**

† Data at high and low temperatures are applicable only within the rated operating free-air temperature ranges of the various devices.



**TYPICAL CHARACTERISTICS**



**Figure 14**

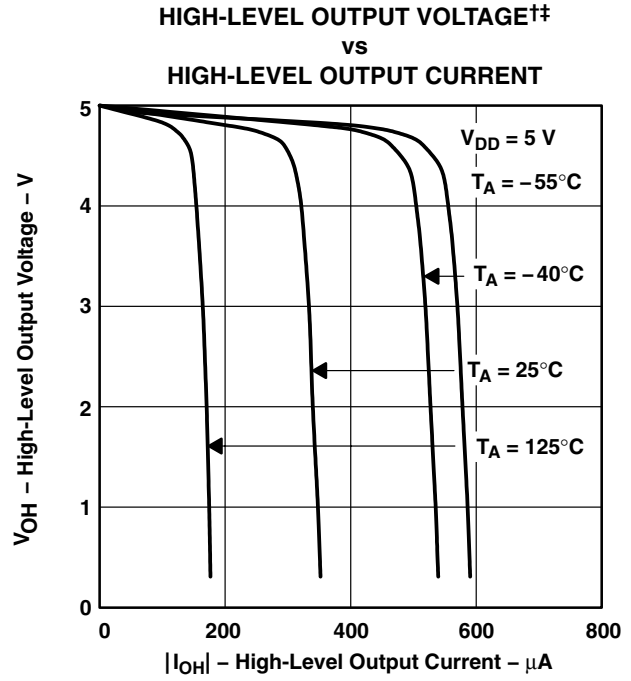

**Figure 15**

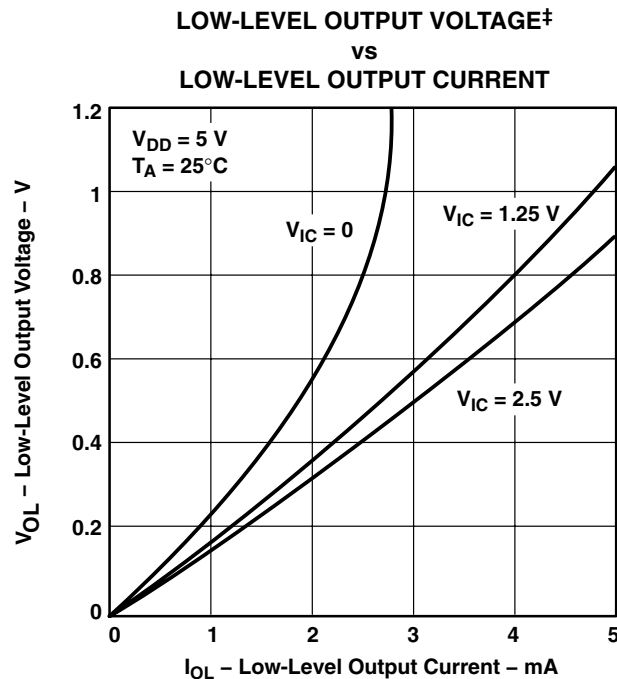

**Figure 16**

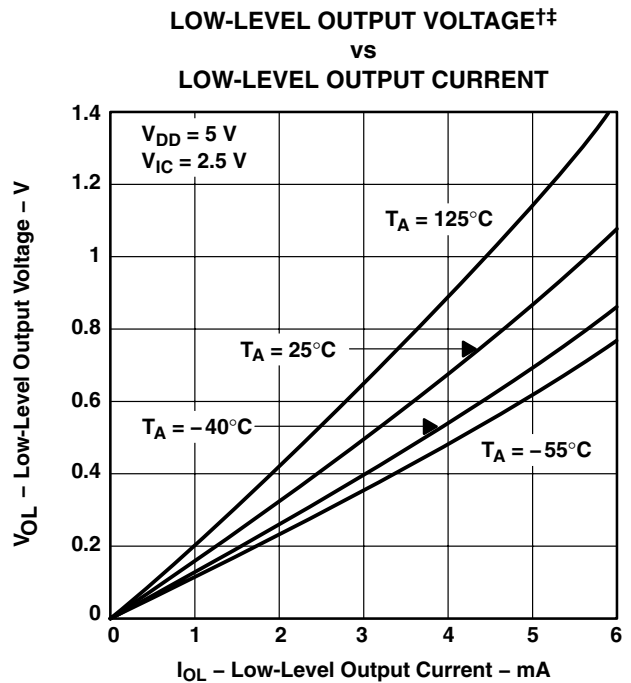

**Figure 17**

† Data at high and low temperatures are applicable only within the rated operating free-air temperature ranges of the various devices.

‡ For curves where  $V_{DD} = 5\text{ V}$ , all loads are referenced to 2.5 V.

# TLC225x-Q1, TLC225xA-Q1 Advanced LinCMOS™ RAIL-TO-RAIL VERY LOW-POWER OPERATIONAL AMPLIFIERS

SGLS188B – OCTOBER 2003 – REVISED APRIL 2008

## TYPICAL CHARACTERISTICS

MAXIMUM POSITIVE PEAK OUTPUT VOLTAGE†  
vs  
OUTPUT CURRENT

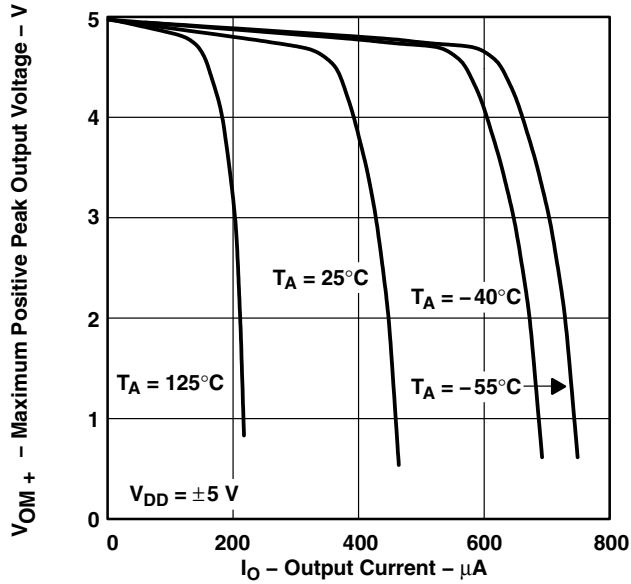

Figure 18

MAXIMUM NEGATIVE PEAK OUTPUT VOLTAGE†  
vs  
OUTPUT CURRENT

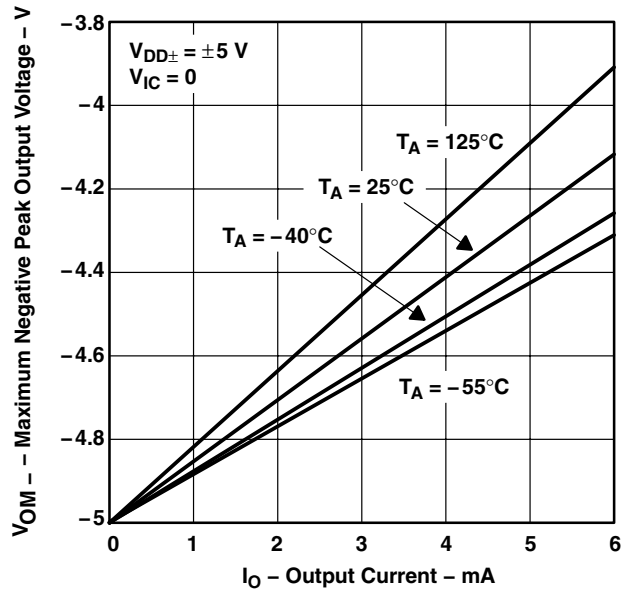

Figure 19

MAXIMUM PEAK-TO-PEAK OUTPUT VOLTAGE‡  
vs  
FREQUENCY

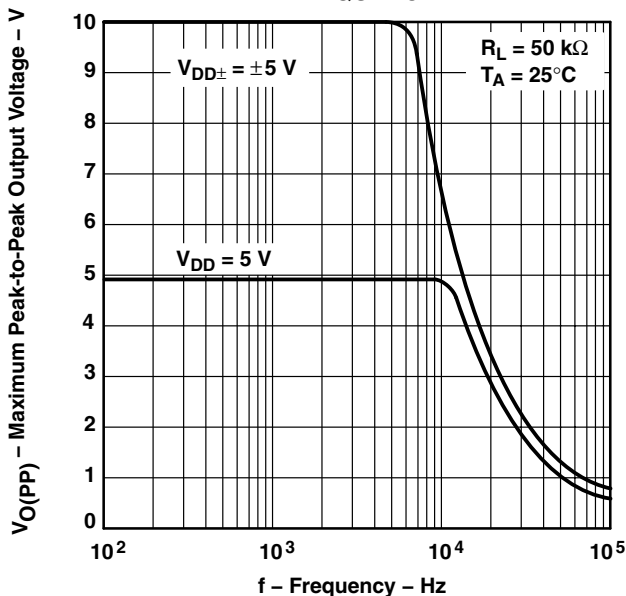

Figure 20

SHORT-CIRCUIT OUTPUT CURRENT  
vs  
SUPPLY VOLTAGE

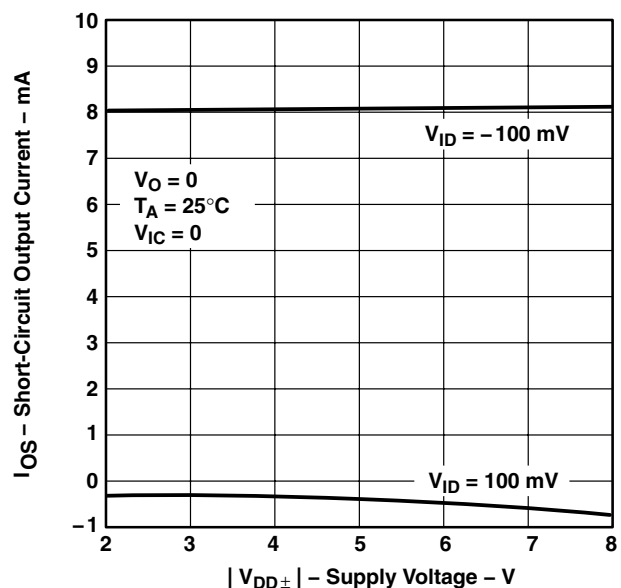

Figure 21

† Data at high and low temperatures are applicable only within the rated operating free-air temperature ranges of the various devices.

‡ For curves where  $V_{DD} = 5\text{ V}$ , all loads are referenced to 2.5 V.



**TYPICAL CHARACTERISTICS**

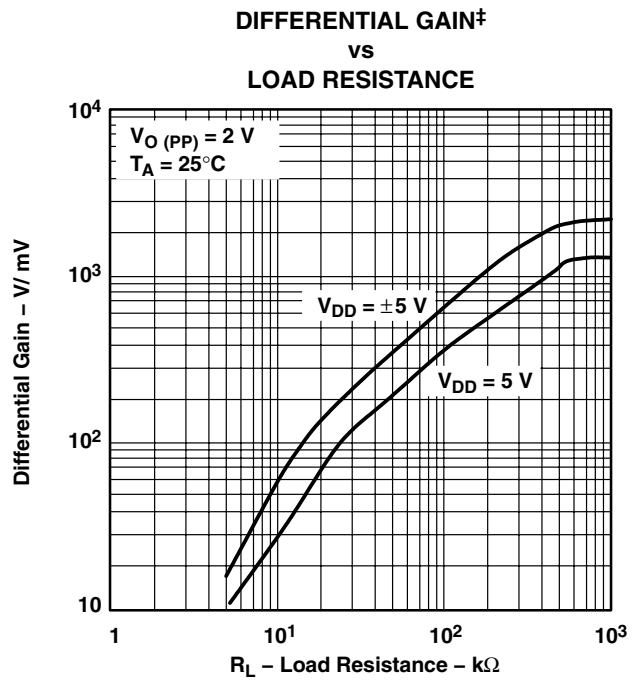
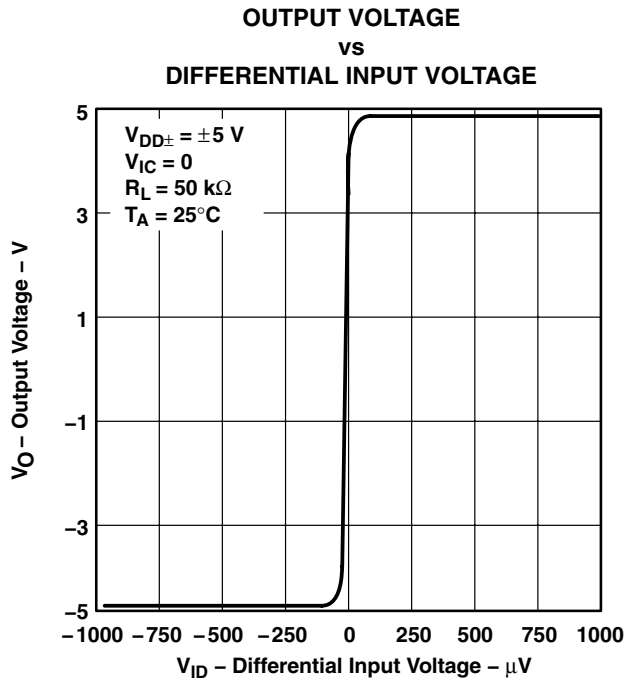
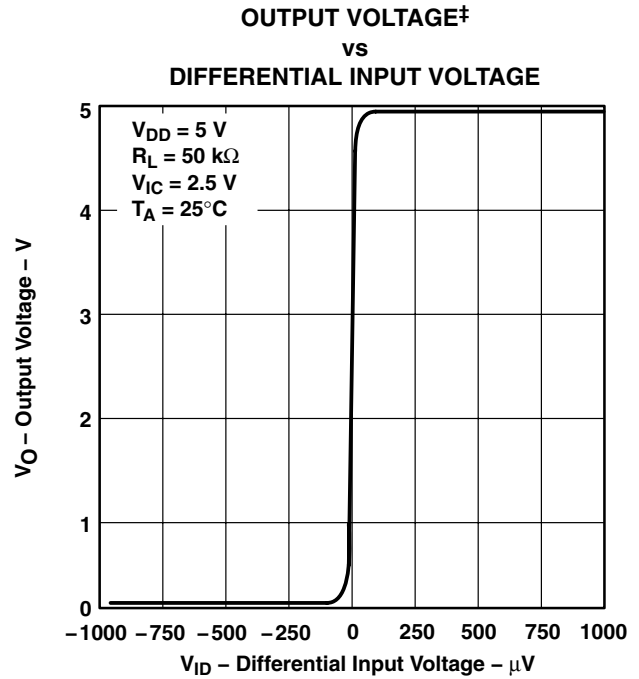
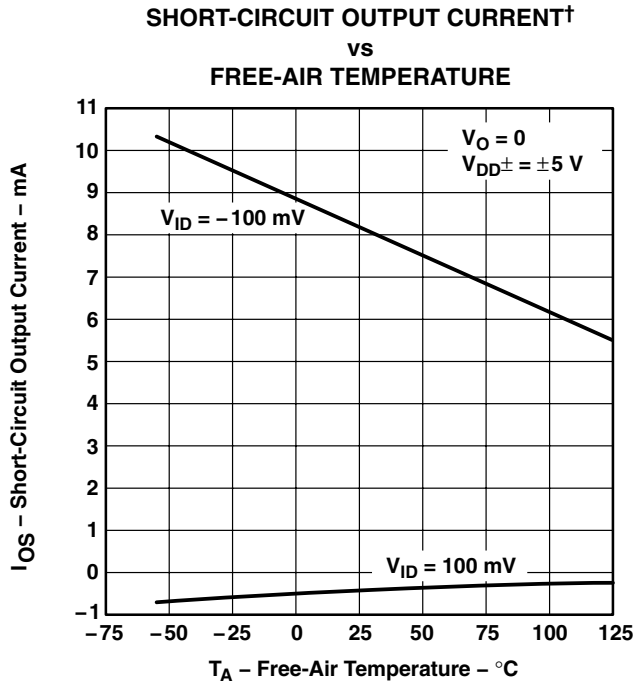

† Data at high and low temperatures are applicable only within the rated operating free-air temperature ranges of the various devices.

‡ For curves where  $V_{DD} = 5\text{ V}$ , all loads are referenced to 2.5 V.

**TLC225x-Q1, TLC225xA-Q1**  
**Advanced LinCMOS™ RAIL-TO-RAIL**  
**VERY LOW-POWER OPERATIONAL AMPLIFIERS**

SGLS188B – OCTOBER 2003 – REVISED APRIL 2008

**TYPICAL CHARACTERISTICS**

**LARGE-SIGNAL DIFFERENTIAL VOLTAGE AMPLIFICATION AND PHASE MARGIN†**

**vs**  
**FREQUENCY**

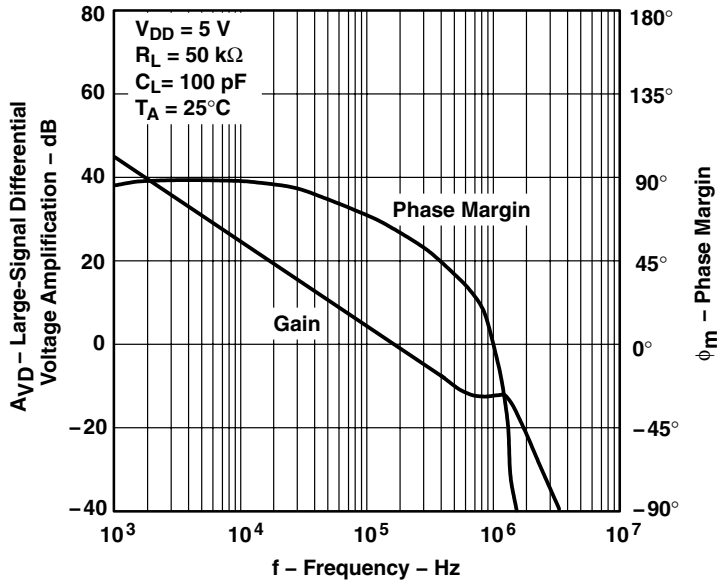

**Figure 26**

**LARGE-SIGNAL DIFFERENTIAL VOLTAGE AMPLIFICATION AND PHASE MARGIN**

**vs**  
**FREQUENCY**

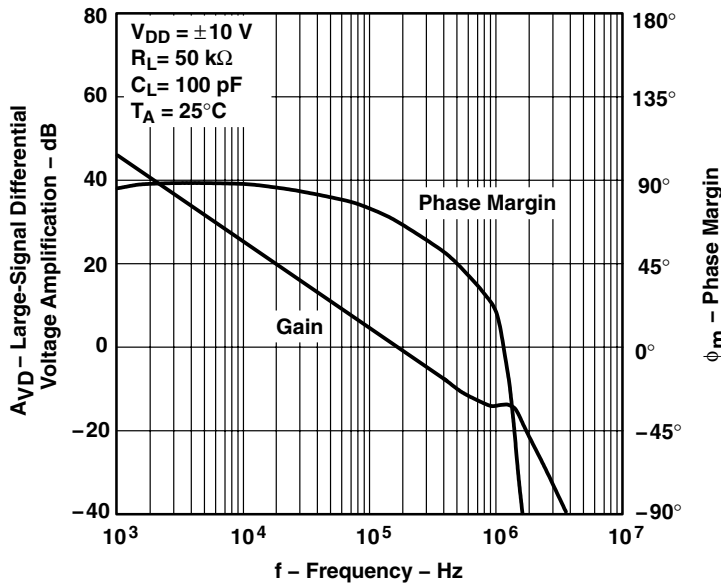
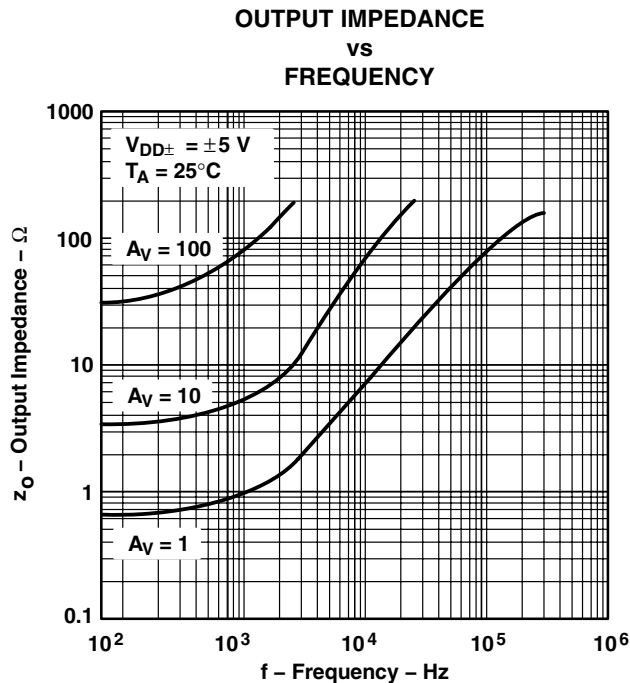
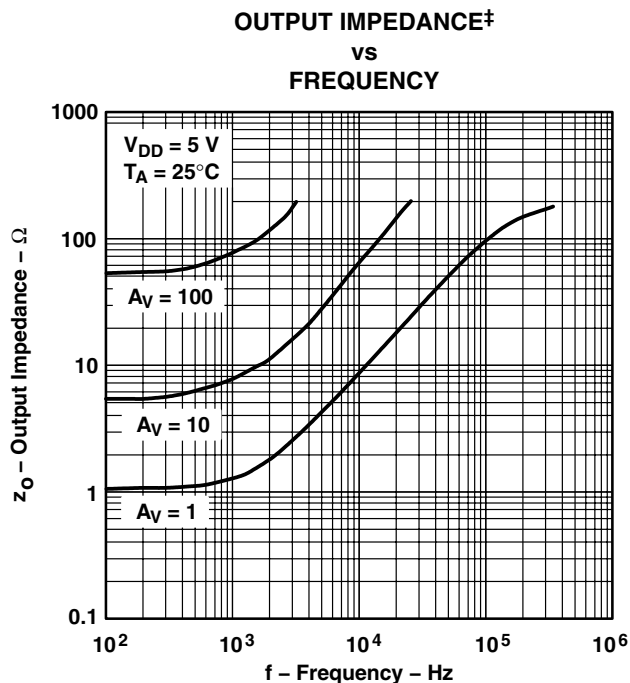
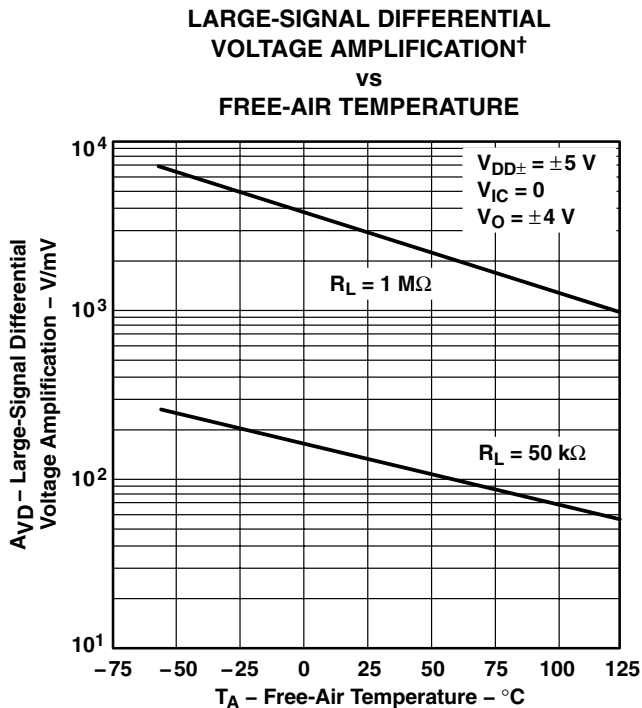
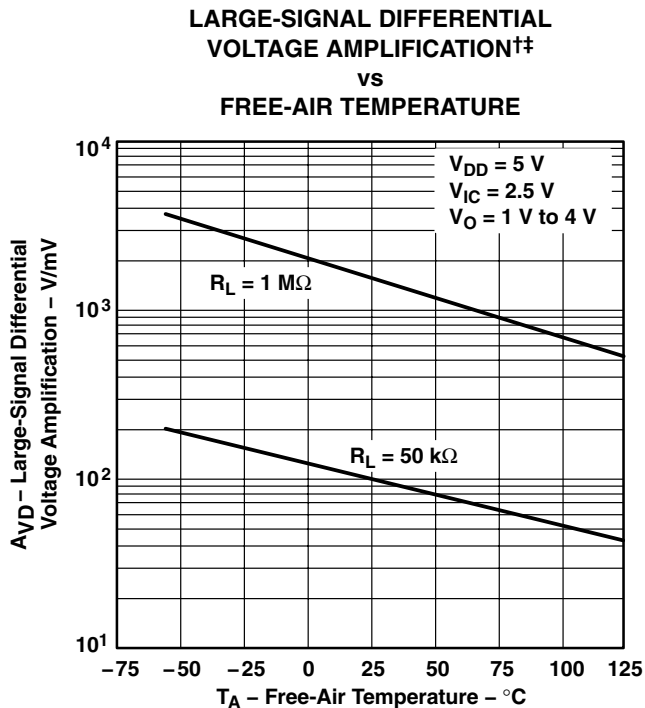

**Figure 27**

† For curves where  $V_{DD} = 5\text{ V}$ , all loads are referenced to 2.5 V.



TYPICAL CHARACTERISTICS



† Data at high and low temperatures are applicable only within the rated operating free-air temperature ranges of the various devices.

‡ For curves where  $V_{DD} = 5\text{ V}$ , all loads are referenced to 2.5 V.

**TYPICAL CHARACTERISTICS**

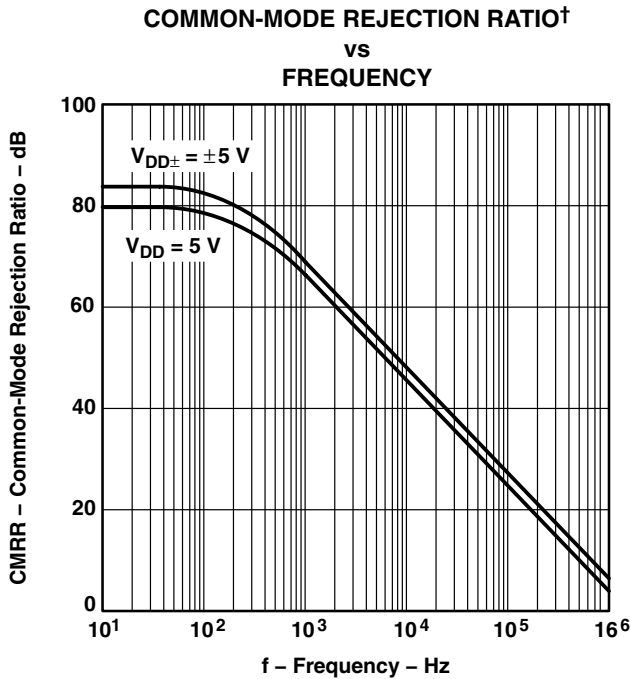

**Figure 32**

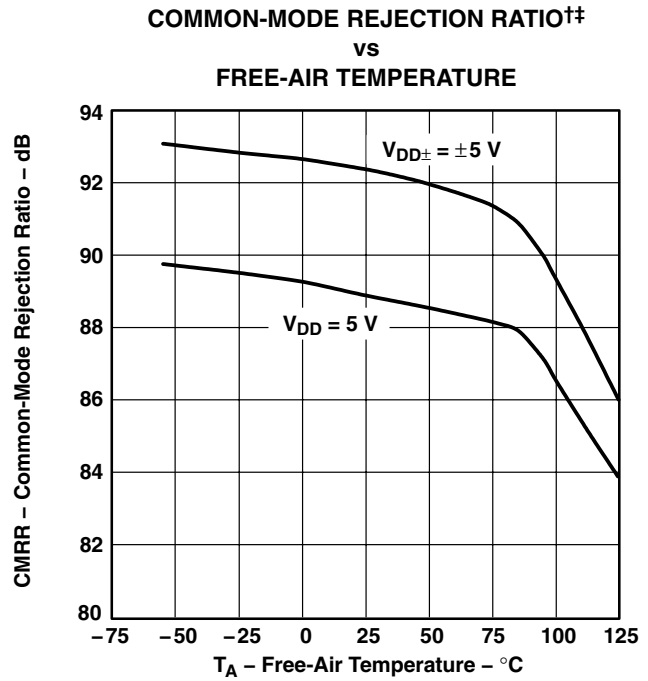

**Figure 33**

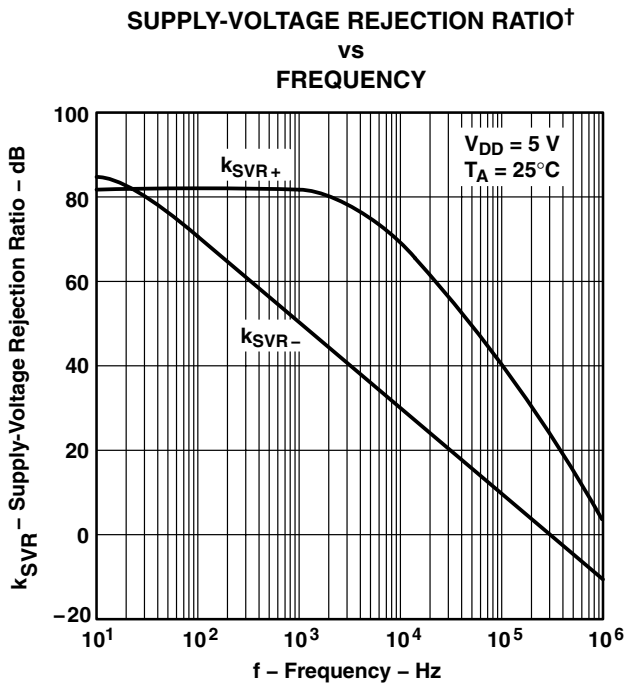

**Figure 34**

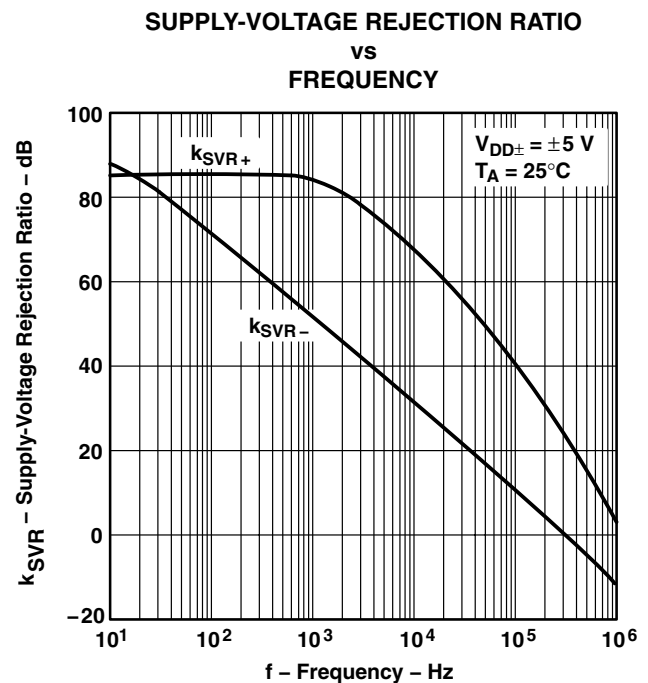
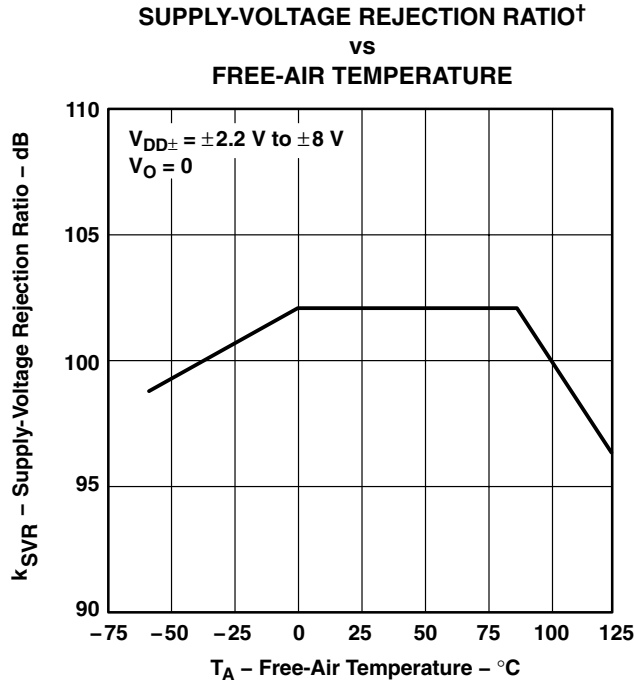

**Figure 35**

† For curves where  $V_{DD} = 5\text{ V}$ , all loads are referenced to 2.5 V.

‡ Data at high and low temperatures are applicable only within the rated operating free-air temperature ranges of the various devices.

**TYPICAL CHARACTERISTICS**



**Figure 36**

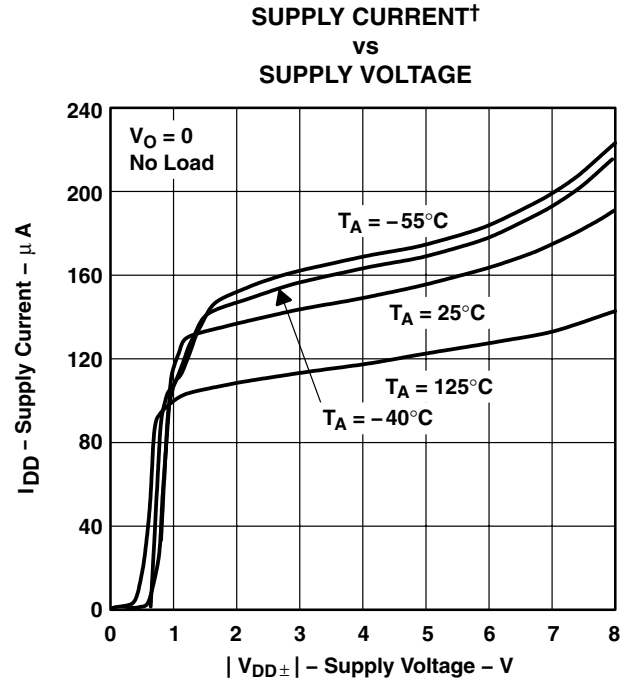

**Figure 37**

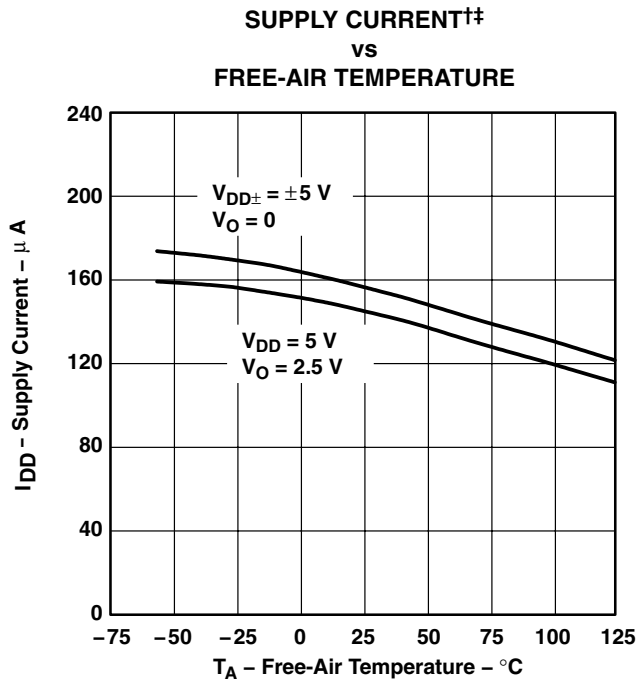

**Figure 38**

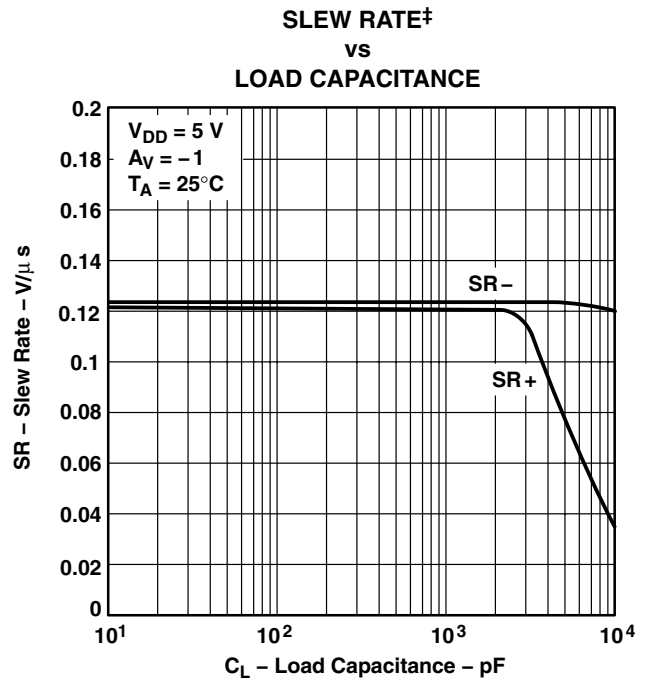

**Figure 39**

† Data at high and low temperatures are applicable only within the rated operating free-air temperature ranges of the various devices.

‡ For curves where  $V_{DD} = 5 \text{ V}$ , all loads are referenced to 2.5 V.

**TLC225x-Q1, TLC225xA-Q1**  
**Advanced LinCMOS™ RAIL-TO-RAIL**  
**VERY LOW-POWER OPERATIONAL AMPLIFIERS**

SGLS188B – OCTOBER 2003 – REVISED APRIL 2008

**TYPICAL CHARACTERISTICS**

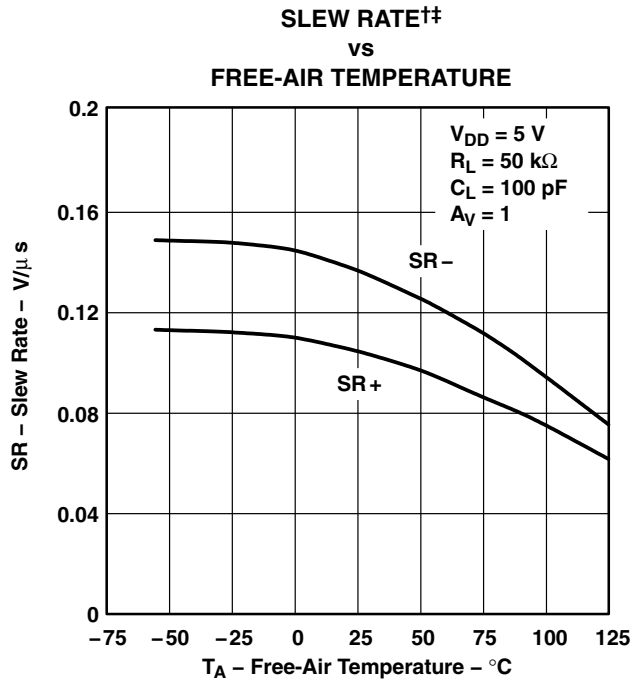

**Figure 40**

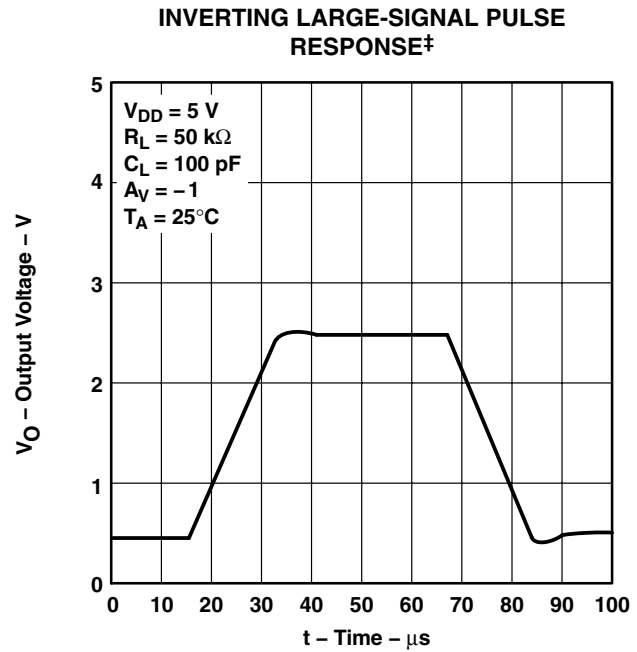

**Figure 41**

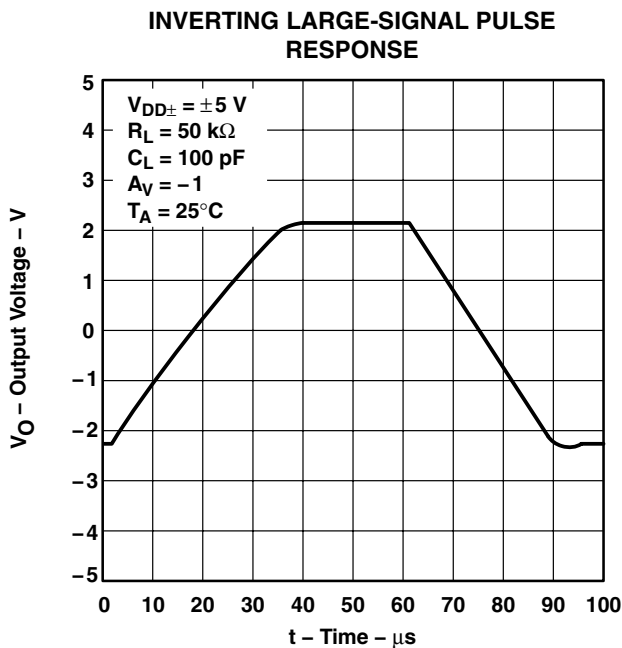

**Figure 42**

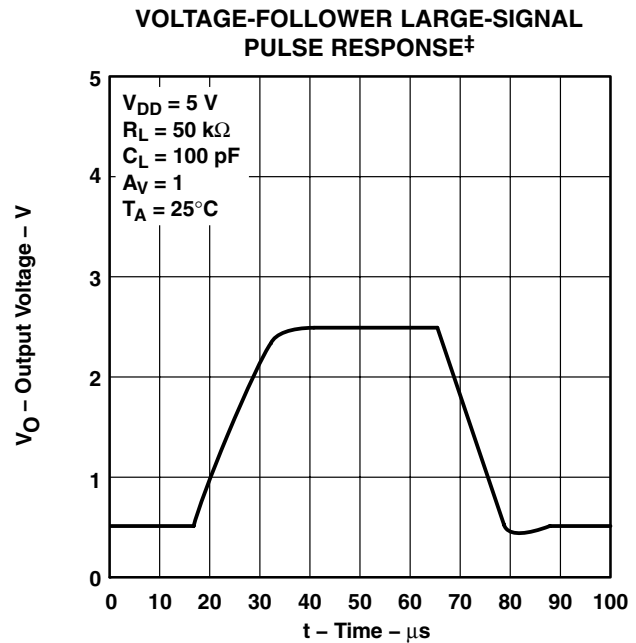

**Figure 43**

† Data at high and low temperatures are applicable only within the rated operating free-air temperature ranges of the various devices.

‡ For curves where  $V_{DD} = 5\text{ V}$ , all loads are referenced to 2.5 V.



TYPICAL CHARACTERISTICS

VOLTAGE-FOLLOWER LARGE-SIGNAL  
 PULSE RESPONSE

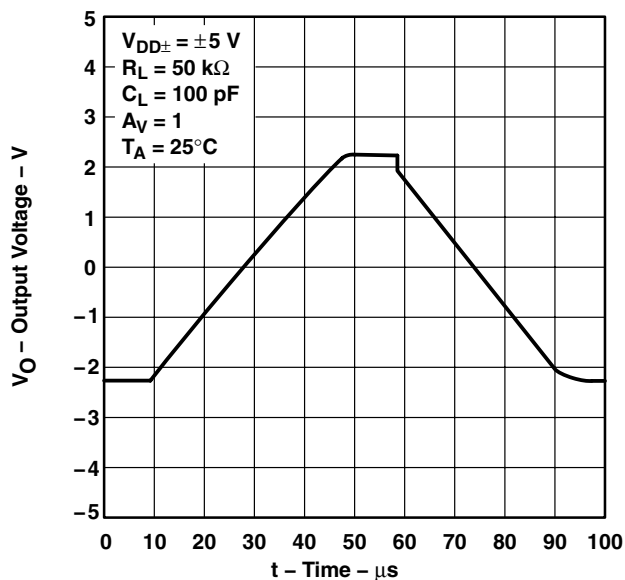

Figure 44

INVERTING SMALL-SIGNAL  
 PULSE RESPONSE†

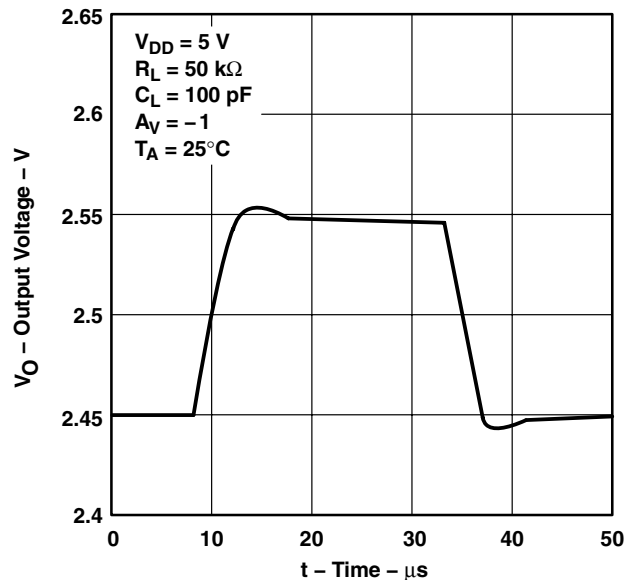

Figure 45

INVERTING SMALL-SIGNAL  
 PULSE RESPONSE

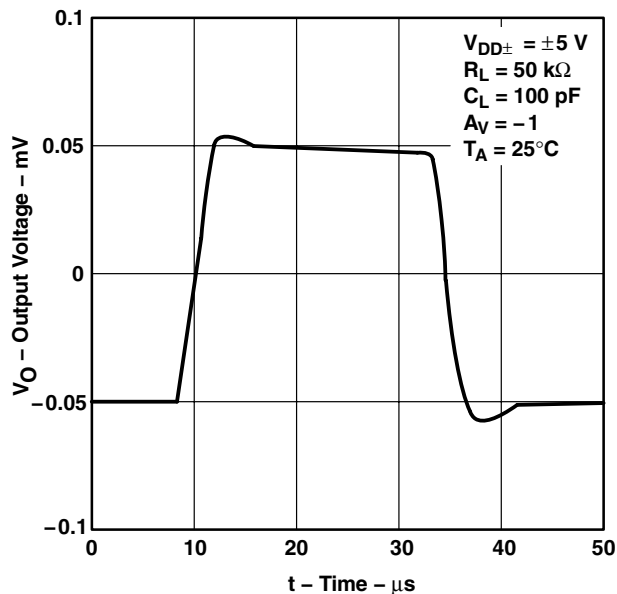

Figure 46

VOLTAGE-FOLLOWER SMALL-SIGNAL  
 PULSE RESPONSE†

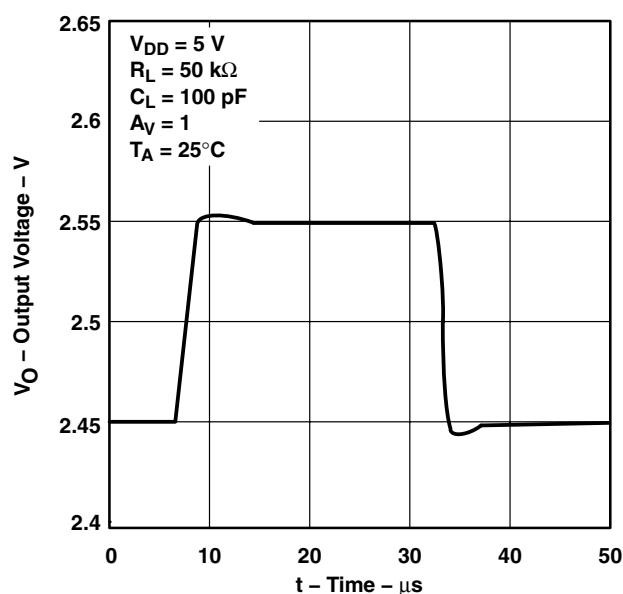

Figure 47

† For curves where  $V_{DD} = 5$  V, all loads are referenced to 2.5 V.

**TLC225x-Q1, TLC225xA-Q1**  
**Advanced LinCMOS™ RAIL-TO-RAIL**  
**VERY LOW-POWER OPERATIONAL AMPLIFIERS**

SGLS188B – OCTOBER 2003 – REVISED APRIL 2008

**TYPICAL CHARACTERISTICS**

**VOLTAGE-FOLLOWER SMALL-SIGNAL PULSE RESPONSE**

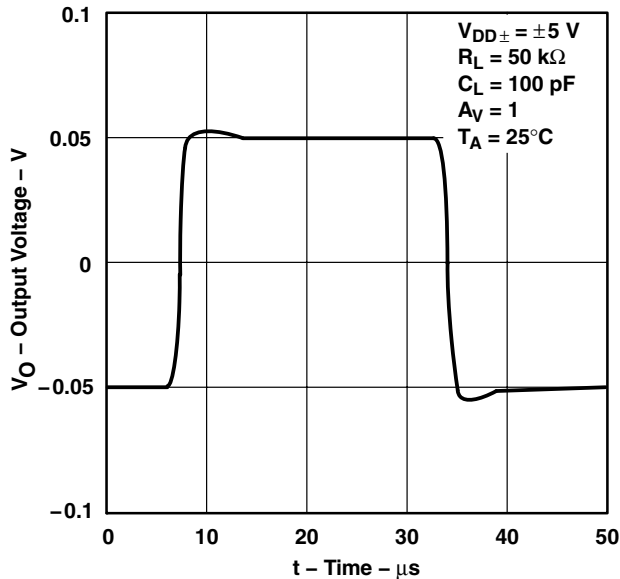

**Figure 48**

**EQUIVALENT INPUT NOISE VOLTAGE† vs FREQUENCY**

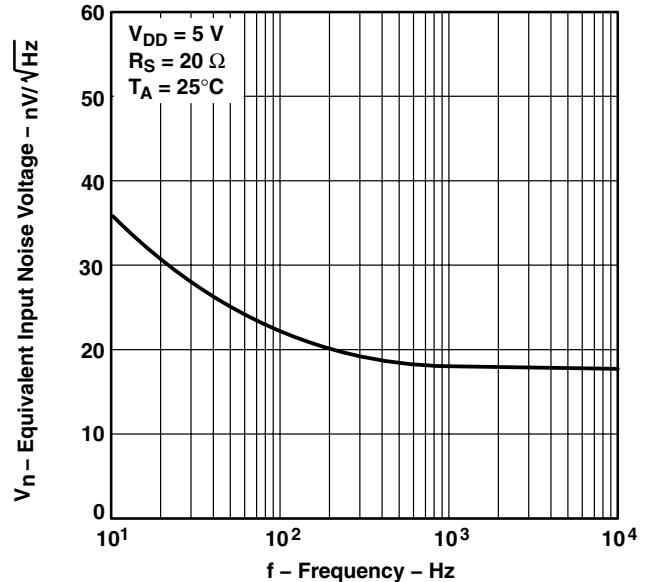

**Figure 49**

**EQUIVALENT INPUT NOISE VOLTAGE vs FREQUENCY**

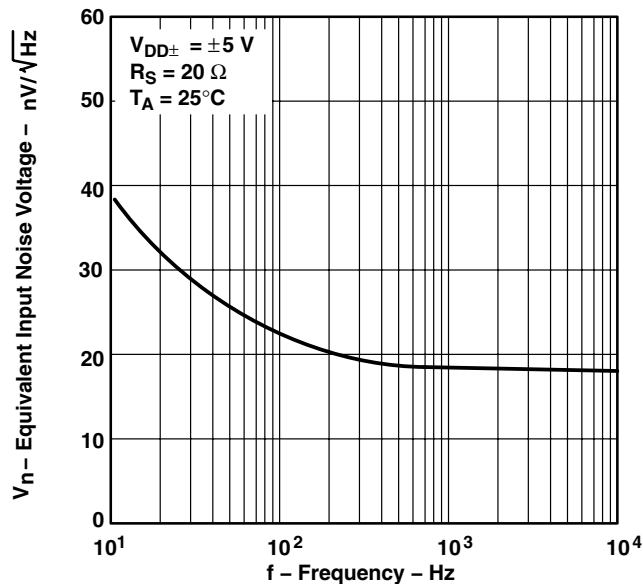

**Figure 50**

**EQUIVALENT INPUT NOISE VOLTAGE OVER A 10-SECOND PERIOD†**

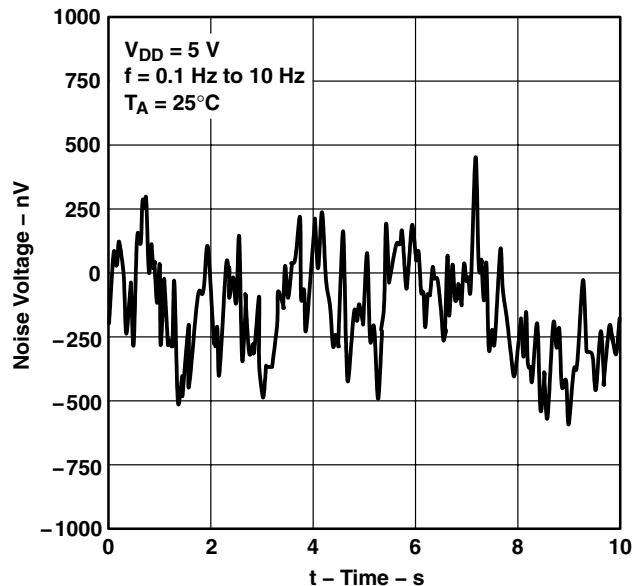

**Figure 51**

† For curves where  $V_{DD} = 5\text{ V}$ , all loads are referenced to 2.5 V.



TYPICAL CHARACTERISTICS

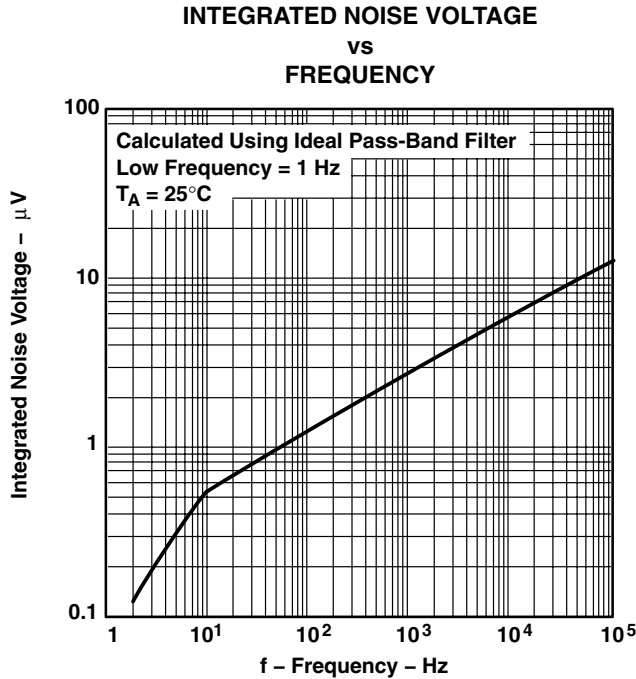

Figure 52

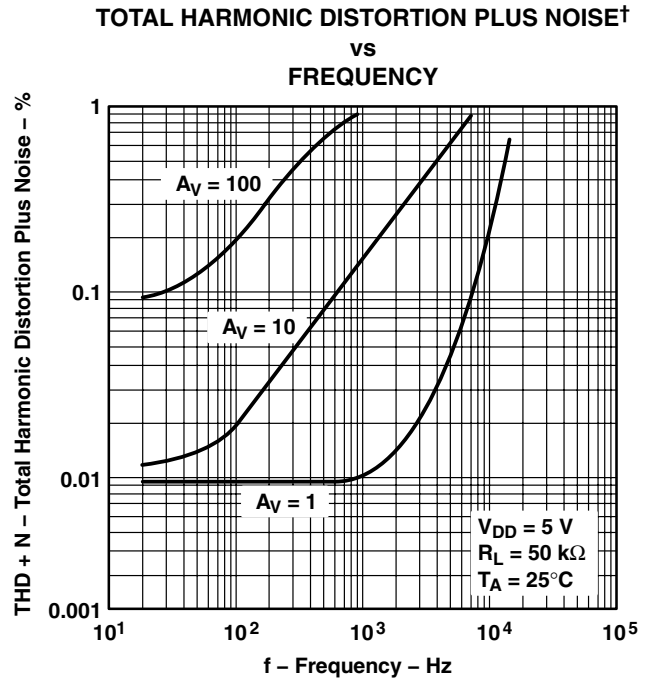

Figure 53

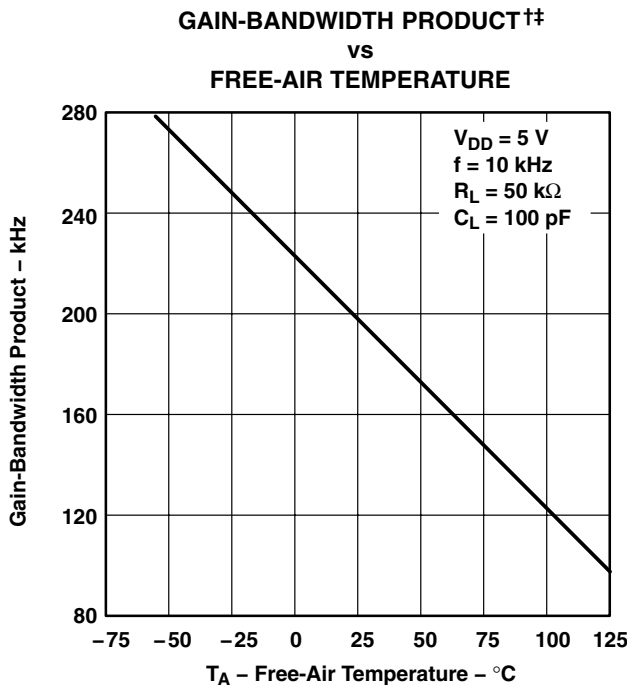

Figure 54

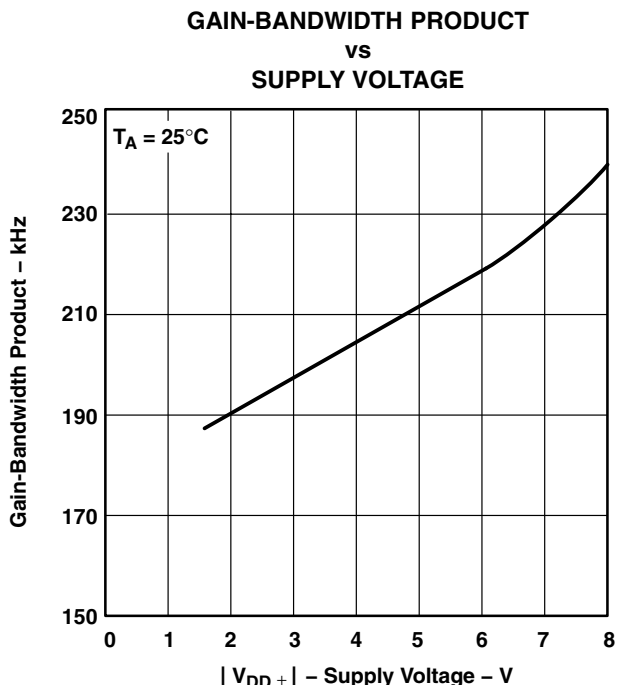
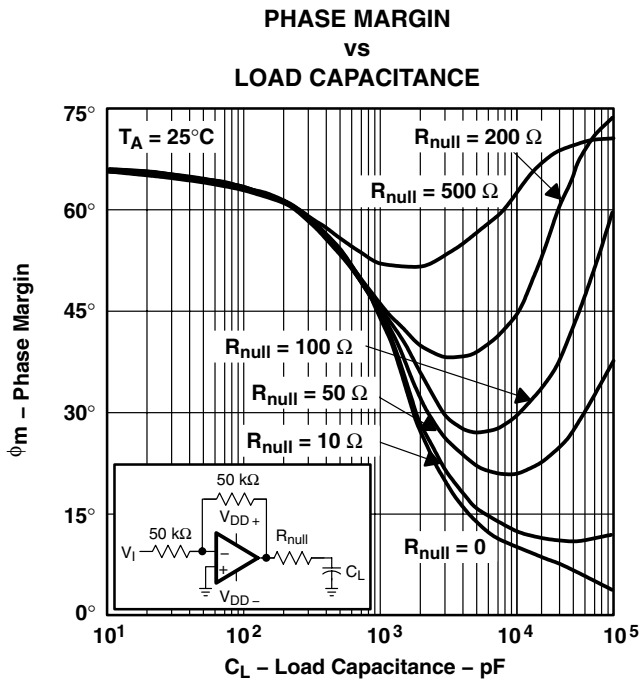

Figure 55

† For curves where  $V_{DD} = 5\text{ V}$ , all loads are referenced to 2.5 V.

†† Data at high and low temperatures are applicable only within the rated operating free-air temperature ranges of the various devices.

**TYPICAL CHARACTERISTICS**



**Figure 56**

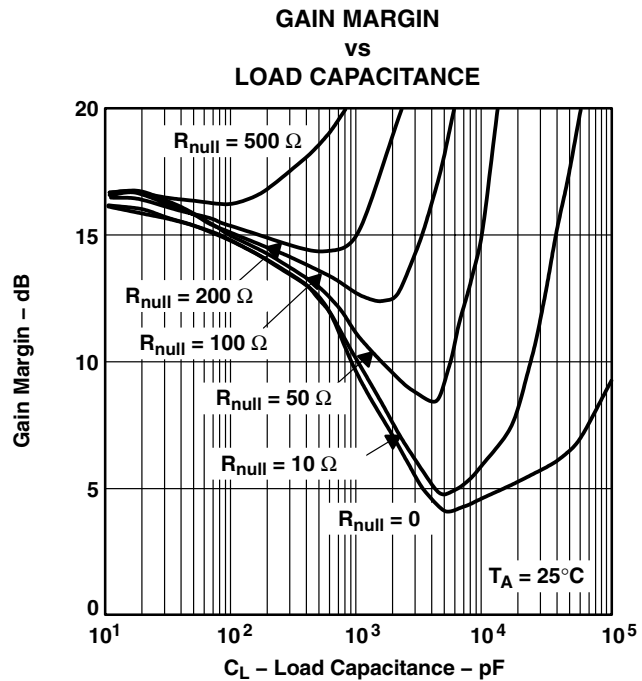

**Figure 57**

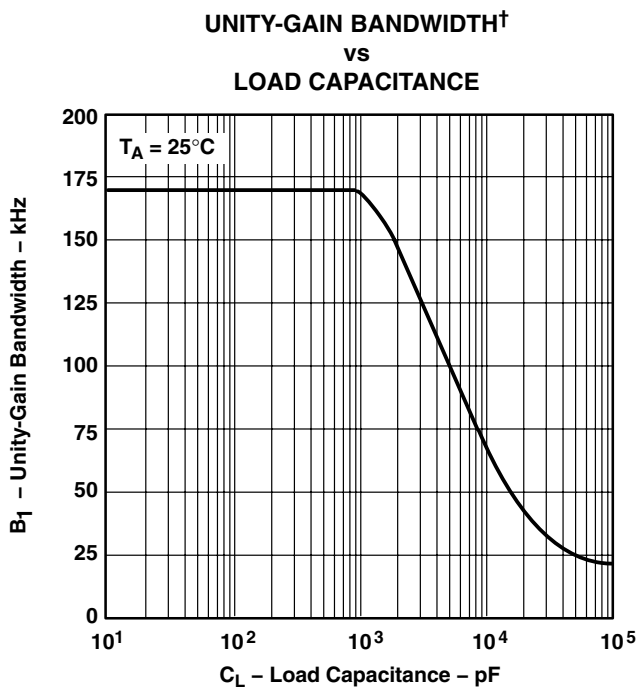

**Figure 58**

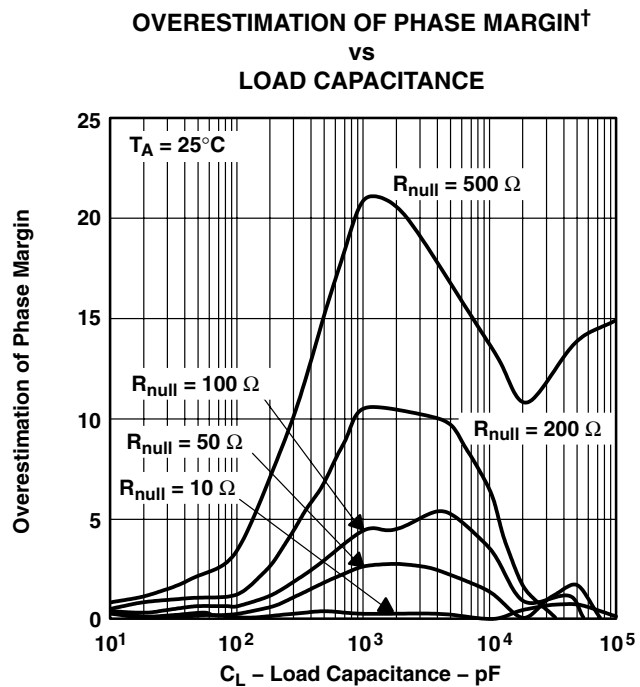

**Figure 59**

† See application information

## APPLICATION INFORMATION

### driving large capacitive loads

The TLC225x is designed to drive larger capacitive loads than most CMOS operational amplifiers. Figure 56 and Figure 57 illustrate its ability to drive loads up to 1000 pF while maintaining good gain and phase margins ( $R_{null} = 0$ ).

A smaller series resistor ( $R_{null}$ ) at the output of the device (see Figure 60) improves the gain and phase margins when driving large capacitive loads. Figure 56 and Figure 57 show the effects of adding series resistances of 10  $\Omega$ , 50  $\Omega$ , 100  $\Omega$ , 200  $\Omega$ , and 500  $\Omega$ . The addition of this series resistor has two effects: the first is that it adds a zero to the transfer function and the second is that it reduces the frequency of the pole associated with the output load in the transfer function.

The zero introduced to the transfer function is equal to the series resistance times the load capacitance. To calculate the improvement in phase margin, equation 1 can be used.

$$\Delta\phi_{m1} = \tan^{-1} \left( 2 \times \pi \times \text{UGBW} \times R_{null} \times C_L \right) \quad (1)$$

Where :

- $\Delta\phi_{m1}$  = Improvement in phase margin
- UGBW = Unity-gain bandwidth frequency
- $R_{null}$  = Output series resistance
- $C_L$  = Load capacitance

The unity-gain bandwidth (UGBW) frequency decreases as the capacitive load increases (see Figure 58). To use equation 1, UGBW must be approximated from Figure 58.

Using equation 1 alone overestimates the improvement in phase margin, as illustrated in Figure 59. The overestimation is caused by the decrease in the frequency of the pole associated with the load, thus providing additional phase shift and reducing the overall improvement in phase margin.

Using Figure 60, with equation 1 enables the designer to choose the appropriate output series resistance to optimize the design of circuits driving large capacitance loads.

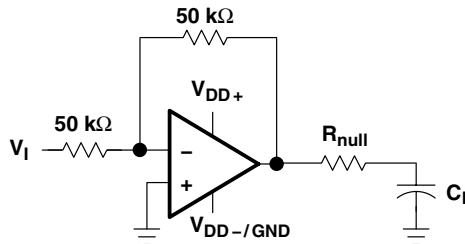

**Figure 60. Series-Resistance Circuit**

# TLC225x-Q1, TLC225xA-Q1 Advanced LinCMOS™ RAIL-TO-RAIL VERY LOW-POWER OPERATIONAL AMPLIFIERS

SGLS188B – OCTOBER 2003 – REVISED APRIL 2008

## APPLICATION INFORMATION

### macromodel information

Macromodel information provided was derived using MicroSim *Parts*™, the model generation software used with MicroSim *PSPice*™. The Boyle macromodel (see Note 5) and subcircuit in Figure 61 are generated using the TLC225x typical electrical and operating characteristics at  $T_A = 25^\circ\text{C}$ . Using this information, output simulations of the following key parameters can be generated to a tolerance of 20% (in most cases):

- Maximum positive output voltage swing
- Maximum negative output voltage swing
- Slew rate
- Quiescent power dissipation
- Input bias current
- Open-loop voltage amplification
- Unity-gain frequency
- Common-mode rejection ratio
- Phase margin
- DC output resistance
- AC output resistance
- Short-circuit output current limit

NOTE 4: G. R. Boyle, B. M. Cohn, D. O. Pederson, and J. E. Solomon, "Macromodeling of Integrated Circuit Operational Amplifiers", *IEEE Journal of Solid-State Circuits*, SC-9, 353 (1974).

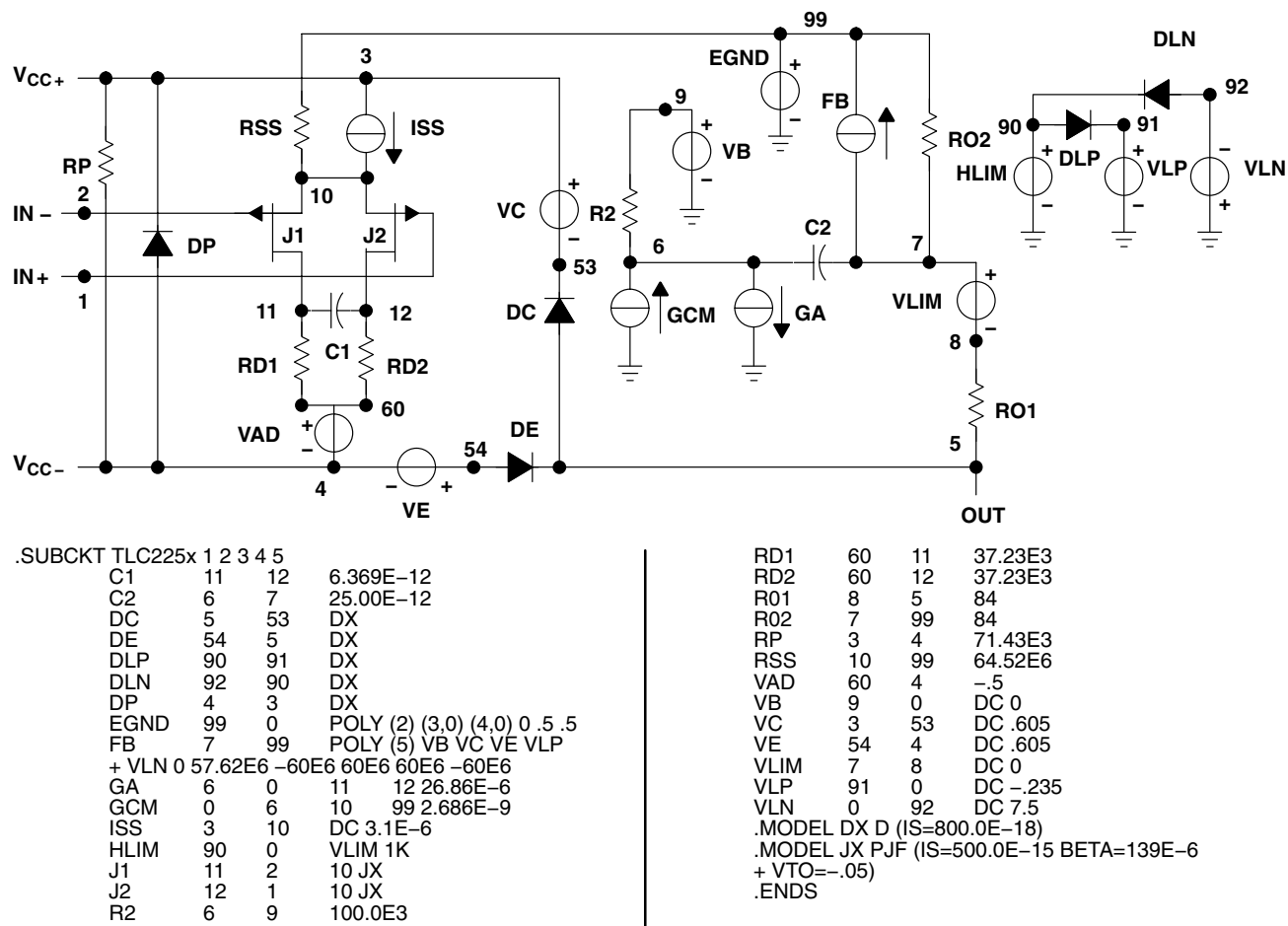

Figure 61. Boyle Macromodel and Subcircuit

*PSPice* and *Parts* are trademarks of MicroSim Corporation.



POST OFFICE BOX 655303 • DALLAS, TEXAS 75265  
POST OFFICE BOX 1443 • HOUSTON, TEXAS 77251-1443

**PACKAGING INFORMATION**

| Orderable Device | Status<br>(1) | Package Type | Package Drawing | Pins | Package Qty | Eco Plan<br>(2)         | Lead/Ball Finish<br>(6) | MSL Peak Temp<br>(3) | Op Temp (°C) | Device Marking<br>(4/5) | Samples                 |
|------------------|---------------|--------------|-----------------|------|-------------|-------------------------|-------------------------|----------------------|--------------|-------------------------|-------------------------|
| TLC2252AQDRG4Q1  | ACTIVE        | SOIC         | D               | 8    | 2500        | Green (RoHS & no Sb/Br) | CU NIPDAU               | Level-1-260C-UNLIM   | -40 to 125   | 2252AQ                  | <a href="#">Samples</a> |
| TLC2252AQDRQ1    | ACTIVE        | SOIC         | D               | 8    | 2500        | Green (RoHS & no Sb/Br) | CU NIPDAU               | Level-1-260C-UNLIM   | -40 to 125   | 2252AQ                  | <a href="#">Samples</a> |
| TLC2252AQPWRG4Q1 | ACTIVE        | TSSOP        | PW              | 8    | 2000        | Green (RoHS & no Sb/Br) | CU NIPDAU               | Level-1-260C-UNLIM   | -40 to 125   | 2252AQ                  | <a href="#">Samples</a> |
| TLC2252QPWRG4Q1  | ACTIVE        | TSSOP        | PW              | 8    | 2000        | Green (RoHS & no Sb/Br) | CU NIPDAU               | Level-1-260C-UNLIM   | -40 to 125   | 2252Q1                  | <a href="#">Samples</a> |
| TLC2254AQPWRG4Q1 | ACTIVE        | TSSOP        | PW              | 14   | 2000        | Green (RoHS & no Sb/Br) | CU NIPDAU               | Level-1-260C-UNLIM   | -40 to 125   | 2254AQ                  | <a href="#">Samples</a> |
| TLC2254AQPWRQ1   | ACTIVE        | TSSOP        | PW              | 14   | 2000        | Green (RoHS & no Sb/Br) | CU NIPDAU               | Level-1-260C-UNLIM   | -40 to 125   | 2254AQ                  | <a href="#">Samples</a> |
| TLC2254QPWRG4Q1  | ACTIVE        | TSSOP        | PW              | 14   | 2000        | Green (RoHS & no Sb/Br) | CU NIPDAU               | Level-1-260C-UNLIM   | -40 to 125   | 2254Q1                  | <a href="#">Samples</a> |

(1) The marketing status values are defined as follows:

**ACTIVE:** Product device recommended for new designs.

**LIFEBUY:** TI has announced that the device will be discontinued, and a lifetime-buy period is in effect.

**NRND:** Not recommended for new designs. Device is in production to support existing customers, but TI does not recommend using this part in a new design.

**PREVIEW:** Device has been announced but is not in production. Samples may or may not be available.

**OBSELETE:** TI has discontinued the production of the device.

(2) Eco Plan - The planned eco-friendly classification: Pb-Free (RoHS), Pb-Free (RoHS Exempt), or Green (RoHS & no Sb/Br) - please check <http://www.ti.com/productcontent> for the latest availability information and additional product content details.

**TBD:** The Pb-Free/Green conversion plan has not been defined.

**Pb-Free (RoHS):** TI's terms "Lead-Free" or "Pb-Free" mean semiconductor products that are compatible with the current RoHS requirements for all 6 substances, including the requirement that lead not exceed 0.1% by weight in homogeneous materials. Where designed to be soldered at high temperatures, TI Pb-Free products are suitable for use in specified lead-free processes.

**Pb-Free (RoHS Exempt):** This component has a RoHS exemption for either 1) lead-based flip-chip solder bumps used between the die and package, or 2) lead-based die adhesive used between the die and leadframe. The component is otherwise considered Pb-Free (RoHS compatible) as defined above.

**Green (RoHS & no Sb/Br):** TI defines "Green" to mean Pb-Free (RoHS compatible), and free of Bromine (Br) and Antimony (Sb) based flame retardants (Br or Sb do not exceed 0.1% by weight in homogeneous material)

(3) MSL, Peak Temp. - The Moisture Sensitivity Level rating according to the JEDEC industry standard classifications, and peak solder temperature.

(4) There may be additional marking, which relates to the logo, the lot trace code information, or the environmental category on the device.

<sup>(5)</sup> Multiple Device Markings will be inside parentheses. Only one Device Marking contained in parentheses and separated by a "--" will appear on a device. If a line is indented then it is a continuation of the previous line and the two combined represent the entire Device Marking for that device.

<sup>(6)</sup> Lead/Ball Finish - Orderable Devices may have multiple material finish options. Finish options are separated by a vertical ruled line. Lead/Ball Finish values may wrap to two lines if the finish value exceeds the maximum column width.

**Important Information and Disclaimer:**The information provided on this page represents TI's knowledge and belief as of the date that it is provided. TI bases its knowledge and belief on information provided by third parties, and makes no representation or warranty as to the accuracy of such information. Efforts are underway to better integrate information from third parties. TI has taken and continues to take reasonable steps to provide representative and accurate information but may not have conducted destructive testing or chemical analysis on incoming materials and chemicals. TI and TI suppliers consider certain information to be proprietary, and thus CAS numbers and other limited information may not be available for release.

In no event shall TI's liability arising out of such information exceed the total purchase price of the TI part(s) at issue in this document sold by TI to Customer on an annual basis.

**OTHER QUALIFIED VERSIONS OF TLC2252-Q1, TLC2252A-Q1, TLC2254-Q1, TLC2254A-Q1 :**

- Catalog: [TLC2252](#), [TLC2252A](#), [TLC2254](#), [TLC2254A](#)
  
- Enhanced Product: [TLC2252A-EP](#), [TLC2254A-EP](#)
  
- Military: [TLC2252M](#), [TLC2252AM](#), [TLC2254M](#), [TLC2254AM](#)

NOTE: Qualified Version Definitions:

- Catalog - TI's standard catalog product
  
- Enhanced Product - Supports Defense, Aerospace and Medical Applications
  
- Military - QML certified for Military and Defense Applications

**TAPE AND REEL INFORMATION**

**QUADRANT ASSIGNMENTS FOR PIN 1 ORIENTATION IN TAPE**

\*All dimensions are nominal

| Device           | Package Type | Package Drawing | Pins | SPQ  | Reel Diameter (mm) | Reel Width W1 (mm) | A0 (mm) | B0 (mm) | K0 (mm) | P1 (mm) | W (mm) | Pin1 Quadrant |
|------------------|--------------|-----------------|------|------|--------------------|--------------------|---------|---------|---------|---------|--------|---------------|
| TLC2252AQPWRG4Q1 | TSSOP        | PW              | 8    | 2000 | 330.0              | 12.4               | 7.0     | 3.6     | 1.6     | 8.0     | 12.0   | Q1            |
| TLC2252QPWRG4Q1  | TSSOP        | PW              | 8    | 2000 | 330.0              | 12.4               | 7.0     | 3.6     | 1.6     | 8.0     | 12.0   | Q1            |
| TLC2254AQPWRG4Q1 | TSSOP        | PW              | 14   | 2000 | 330.0              | 12.4               | 6.9     | 5.6     | 1.6     | 8.0     | 12.0   | Q1            |
| TLC2254AQPWRQ1   | TSSOP        | PW              | 14   | 2000 | 330.0              | 12.4               | 6.9     | 5.6     | 1.6     | 8.0     | 12.0   | Q1            |
| TLC2254QPWRG4Q1  | TSSOP        | PW              | 14   | 2000 | 330.0              | 12.4               | 6.9     | 5.6     | 1.6     | 8.0     | 12.0   | Q1            |

**TAPE AND REEL BOX DIMENSIONS**

\*All dimensions are nominal

| Device           | Package Type | Package Drawing | Pins | SPQ  | Length (mm) | Width (mm) | Height (mm) |
|------------------|--------------|-----------------|------|------|-------------|------------|-------------|
| TLC2252AQPWRG4Q1 | TSSOP        | PW              | 8    | 2000 | 367.0       | 367.0      | 35.0        |
| TLC2252QPWRG4Q1  | TSSOP        | PW              | 8    | 2000 | 367.0       | 367.0      | 35.0        |
| TLC2254AQPWRG4Q1 | TSSOP        | PW              | 14   | 2000 | 367.0       | 367.0      | 35.0        |
| TLC2254AQPWRQ1   | TSSOP        | PW              | 14   | 2000 | 367.0       | 367.0      | 35.0        |
| TLC2254QPWRG4Q1  | TSSOP        | PW              | 14   | 2000 | 367.0       | 367.0      | 35.0        |



PW (R-PDSO-G14)

PLASTIC SMALL OUTLINE



4211284-2/G 08/15

- NOTES:
- All linear dimensions are in millimeters.
  - This drawing is subject to change without notice.
  - Publication IPC-7351 is recommended for alternate designs.
  - Laser cutting apertures with trapezoidal walls and also rounding corners will offer better paste release. Customers should contact their board assembly site for stencil design recommendations. Refer to IPC-7525 for other stencil recommendations.
  - Customers should contact their board fabrication site for solder mask tolerances between and around signal pads.



D0008A

# PACKAGE OUTLINE

SOIC - 1.75 mm max height

SMALL OUTLINE INTEGRATED CIRCUIT



4214825/C 02/2019

NOTES:

1. Linear dimensions are in inches [millimeters]. Dimensions in parenthesis are for reference only. Controlling dimensions are in inches. Dimensioning and tolerancing per ASME Y14.5M.
2. This drawing is subject to change without notice.
3. This dimension does not include mold flash, protrusions, or gate burrs. Mold flash, protrusions, or gate burrs shall not exceed  $.006$  [0.15] per side.
4. This dimension does not include interlead flash.
5. Reference JEDEC registration MS-012, variation AA.

# EXAMPLE BOARD LAYOUT

D0008A

SOIC - 1.75 mm max height

SMALL OUTLINE INTEGRATED CIRCUIT



LAND PATTERN EXAMPLE  
 EXPOSED METAL SHOWN  
 SCALE:8X



SOLDER MASK DETAILS

4214825/C 02/2019

NOTES: (continued)

- 6. Publication IPC-7351 may have alternate designs.
- 7. Solder mask tolerances between and around signal pads can vary based on board fabrication site.

# EXAMPLE STENCIL DESIGN

D0008A

SOIC - 1.75 mm max height

SMALL OUTLINE INTEGRATED CIRCUIT



SOLDER PASTE EXAMPLE  
BASED ON .005 INCH [0.125 MM] THICK STENCIL  
SCALE:8X

4214825/C 02/2019

NOTES: (continued)

8. Laser cutting apertures with trapezoidal walls and rounded corners may offer better paste release. IPC-7525 may have alternate design recommendations.
9. Board assembly site may have different recommendations for stencil design.

PW0008A



PACKAGE OUTLINE  
TSSOP - 1.2 mm max height

SMALL OUTLINE PACKAGE

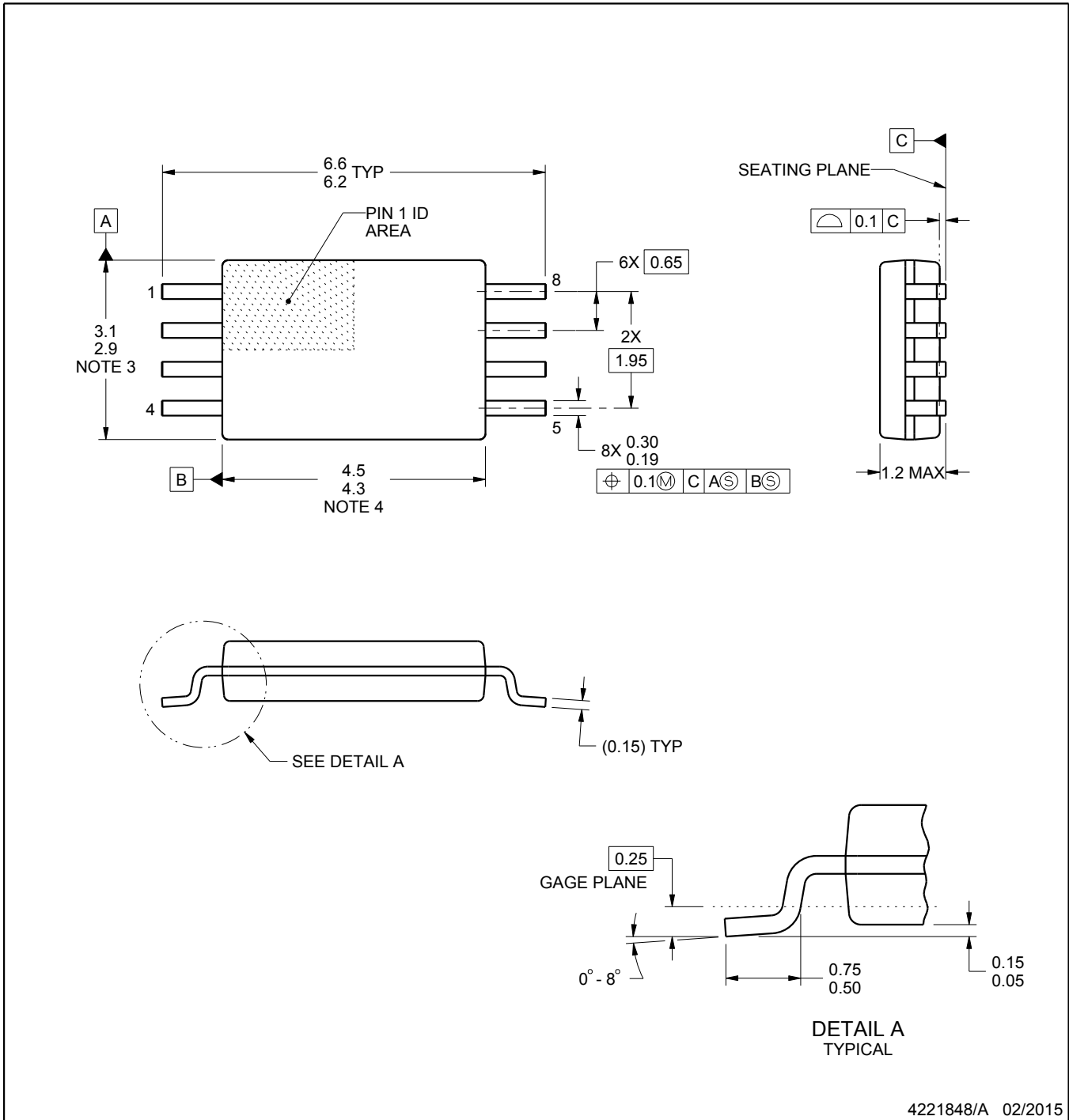

4221848/A 02/2015

NOTES:

1. All linear dimensions are in millimeters. Any dimensions in parenthesis are for reference only. Dimensioning and tolerancing per ASME Y14.5M.
2. This drawing is subject to change without notice.
3. This dimension does not include mold flash, protrusions, or gate burrs. Mold flash, protrusions, or gate burrs shall not exceed 0.15 mm per side.
4. This dimension does not include interlead flash. Interlead flash shall not exceed 0.25 mm per side.
5. Reference JEDEC registration MO-153, variation AA.

# EXAMPLE BOARD LAYOUT

PW0008A

TSSOP - 1.2 mm max height

SMALL OUTLINE PACKAGE

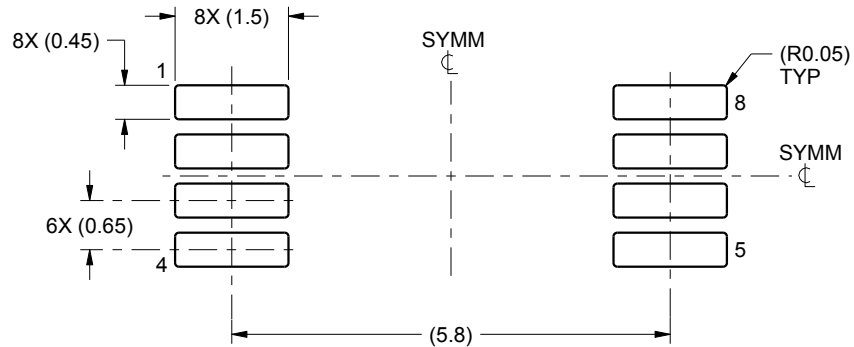

LAND PATTERN EXAMPLE  
SCALE:10X



SOLDER MASK DETAILS  
NOT TO SCALE

4221848/A 02/2015

NOTES: (continued)

- 6. Publication IPC-7351 may have alternate designs.
- 7. Solder mask tolerances between and around signal pads can vary based on board fabrication site.

# EXAMPLE STENCIL DESIGN

PW0008A

TSSOP - 1.2 mm max height

SMALL OUTLINE PACKAGE



SOLDER PASTE EXAMPLE  
BASED ON 0.125 mm THICK STENCIL  
SCALE:10X

4221848/A 02/2015

NOTES: (continued)

8. Laser cutting apertures with trapezoidal walls and rounded corners may offer better paste release. IPC-7525 may have alternate design recommendations.
9. Board assembly site may have different recommendations for stencil design.

## IMPORTANT NOTICE AND DISCLAIMER

TI PROVIDES TECHNICAL AND RELIABILITY DATA (INCLUDING DATASHEETS), DESIGN RESOURCES (INCLUDING REFERENCE DESIGNS), APPLICATION OR OTHER DESIGN ADVICE, WEB TOOLS, SAFETY INFORMATION, AND OTHER RESOURCES "AS IS" AND WITH ALL FAULTS, AND DISCLAIMS ALL WARRANTIES, EXPRESS AND IMPLIED, INCLUDING WITHOUT LIMITATION ANY IMPLIED WARRANTIES OF MERCHANTABILITY, FITNESS FOR A PARTICULAR PURPOSE OR NON-INFRINGEMENT OF THIRD PARTY INTELLECTUAL PROPERTY RIGHTS.

These resources are intended for skilled developers designing with TI products. You are solely responsible for (1) selecting the appropriate TI products for your application, (2) designing, validating and testing your application, and (3) ensuring your application meets applicable standards, and any other safety, security, or other requirements. These resources are subject to change without notice. TI grants you permission to use these resources only for development of an application that uses the TI products described in the resource. Other reproduction and display of these resources is prohibited. No license is granted to any other TI intellectual property right or to any third party intellectual property right. TI disclaims responsibility for, and you will fully indemnify TI and its representatives against, any claims, damages, costs, losses, and liabilities arising out of your use of these resources.

TI's products are provided subject to TI's Terms of Sale ([www.ti.com/legal/termsofsale.html](http://www.ti.com/legal/termsofsale.html)) or other applicable terms available either on [ti.com](http://ti.com) or provided in conjunction with such TI products. TI's provision of these resources does not expand or otherwise alter TI's applicable warranties or warranty disclaimers for TI products.

Mailing Address: Texas Instruments, Post Office Box 655303, Dallas, Texas 75265  
Copyright © 2019, Texas Instruments Incorporated

## Looking for pricing, stock, or lifecycle information?

Click below to explore more details on WIN SOURCE:

 [View TLC2252QDRQ1](#) on WIN SOURCE

 [Texas Instruments](#) Information

## Optimize Your Supply Chain with WIN SOURCE Solutions

-  Global Sourcing Solution
-  Obsolete Management
-  Cost Control Management
-  Shortage Management
-  Alternative Solution
-  Excess Inventory Management