



**THE DATASHEET OF  
DAC7724NB/750G4**





# SPECIFICATION (DUAL SUPPLY)

At  $T_A = -40^{\circ}\text{C}$  to  $+85^{\circ}\text{C}$ ,  $V_{CC} = +15\text{V}$ ,  $V_{DD} = +5\text{V}$ ,  $V_{SS} = -15\text{V}$ ,  $V_{REFH} = +10\text{V}$ ,  $V_{REFL} = -10\text{V}$ , unless otherwise noted.

PARAMETER	CONDITIONS	DAC7724N, U DAC7725N, U			DAC7724NB, UB DAC7725NB, UB			UNITS
		MIN	TYP	MAX	MIN	TYP	MAX	
<b>ACCURACY</b>								
Linearity Error				$\pm 2$			$\pm 1$	LSB <sup>(1)</sup>
Linearity Matching <sup>(2)</sup>				$\pm 2$			$\pm 1$	LSB
Differential Linearity Error				$\pm 1$			$\pm 1$	LSB
Monotonicity	$T_{MIN}$ to $T_{MAX}$	12			*		*	Bits
Zero-Scale Error	Code = 000 <sub>H</sub>			$\pm 2$			*	LSB
Zero-Scale Drift			1			*		ppm/ $^{\circ}\text{C}$
Zero-Scale Matching <sup>(2)</sup>				$\pm 2$			$\pm 1$	LSB
Full-Scale Error	Code = FFF <sub>H</sub>			$\pm 2$			*	LSB
Full-Scale Matching <sup>(2)</sup>				$\pm 2$			$\pm 1$	LSB
Power Supply Sensitivity	At Full Scale		10			*		ppm/V
<b>ANALOG OUTPUT</b>								
Voltage Output <sup>(3)</sup>		$V_{REFL}$		$V_{REFH}$	*		*	V
Output Current		$\pm 5$			*		*	mA
Load Capacitance	No Oscillation		500			*		pF
Short-Circuit Current			$\pm 20$			*		mA
Short-Circuit Duration	To $V_{SS}$ , $V_{CC}$ , or GND		Indefinite			*		
<b>REFERENCE INPUT</b>								
$V_{REFH}$ Input Range		$V_{REFL} + 1.25$		+10	*		*	V
$V_{REFL}$ Input Range		-10		$V_{REFH} - 1.25$	*		*	V
Ref High Input Current		-0.5		3.0	*		*	mA
Ref Low Input Current		-3.5		0	*		*	mA
<b>DYNAMIC PERFORMANCE</b>								
Settling Time	To $\pm 0.012\%$ , 20V Output Step		8	10		*	*	$\mu\text{s}$
Channel-to-Channel Crosstalk	Full-Scale Step		0.25			*		LSB
Digital Feedthrough			2				*	nV-s
Output Noise Voltage	$f = 10\text{kHz}$		65			*		nV/ $\sqrt{\text{Hz}}$
<b>DIGITAL INPUT/OUTPUT</b>								
Logic Family		TTL-Compatible CMOS			*			
Logic Levels								
$V_{IH}$	$I_{IH} \leq \pm 10\mu\text{A}$	2.4		$V_{DD} + 0.3$	*		*	V
$V_{IL}$	$I_{IL} \leq \pm 10\mu\text{A}$	-0.3		0.8	*		*	V
$V_{OH}$	$I_{OH} = -0.8\text{mA}$	3.6		$V_{DD}$	*		*	V
$V_{OL}$	$I_{OL} = 1.6\text{mA}$	0.0		0.4	*		*	V
Data Format		Straight Binary				*		
<b>POWER SUPPLY REQUIREMENTS</b>								
$V_{DD}$		+4.75		+5.25	*		*	V
$V_{CC}$		+14.25		+15.75	*		*	V
$V_{SS}$		-14.25		-15.75	*		*	V
$I_{DD}$			50			*	*	$\mu\text{A}$
$I_{CC}$			6	8.5		*	*	mA
$I_{SS}$		-8	-6		*	*	*	mA
Power Dissipation			180	250		*	*	mW
<b>TEMPERATURE RANGE</b>								
Specified Performance		-40		+85	*		*	$^{\circ}\text{C}$

NOTES: (1) LSB means Least Significant Bit, when  $V_{REFH}$  equals +10V and  $V_{REFL}$  equals -10V, then one LSB equals 4.88mV. (2) All DAC outputs will match within the specified error band. (3) Ideal output voltage, does not take into account zero or full-scale error.

The information provided herein is believed to be reliable; however, BURR-BROWN assumes no responsibility for inaccuracies or omissions. BURR-BROWN assumes no responsibility for the use of this information, and all use of such information shall be entirely at the user's own risk. Prices and specifications are subject to change without notice. No patent rights or licenses to any of the circuits described herein are implied or granted to any third party. BURR-BROWN does not authorize or warrant any BURR-BROWN product for use in life support devices and/or systems.

# SPECIFICATION (SINGLE SUPPLY)

At  $T_A = -40^{\circ}\text{C}$  to  $+85^{\circ}\text{C}$ ,  $V_{CC} = +15\text{V}$ ,  $V_{DD} = +5\text{V}$ ,  $V_{SS} = \text{GND}$ ,  $V_{REFH} = +10\text{V}$ ,  $V_{REFL} = 0\text{V}$ , unless otherwise noted.

PARAMETER	CONDITIONS	DAC7724N, U DAC7725N, U			DAC7724NB, UB DAC7725NB, UB			UNITS
		MIN	TYP	MAX	MIN	TYP	MAX	
<b>ACCURACY</b>								
Linearity Error <sup>(1)</sup>				$\pm 2$			$\pm 1$	LSB <sup>(2)</sup>
Linearity Matching <sup>(3)</sup>				$\pm 2$			$\pm 1$	LSB
Differential Linearity Error				$\pm 1$			$\pm 1$	LSB
Monotonicity	$T_{\text{MIN}}$ to $T_{\text{MAX}}$	12			*			Bits
Zero-Scale Error	Code = 004 <sub>H</sub>			$\pm 4$			*	LSB
Zero-Scale Drift			2			*		ppm/ $^{\circ}\text{C}$
Zero-Scale Matching <sup>(3)</sup>				$\pm 4$			$\pm 2$	LSB
Full-Scale Error	Code = FFF <sub>H</sub>			$\pm 4$			*	LSB
Full-Scale Matching <sup>(3)</sup>				$\pm 4$			$\pm 2$	LSB
Power Supply Sensitivity	At Full Scale		20			*		ppm/V
<b>ANALOG OUTPUT</b>								
Voltage Output <sup>(4)</sup>		$V_{\text{REFL}}$		$V_{\text{REFH}}$	*		*	V
Output Current		$\pm 5$			*			mA
Load Capacitance	No Oscillation		500			*		pF
Short-Circuit Current			$\pm 20$			*		mA
Short-Circuit Duration	To $V_{CC}$ or GND		Indefinite			*		
<b>REFERENCE INPUT</b>								
$V_{\text{REFH}}$ Input Range		$V_{\text{REFL}} + 1.25$		+10	*		*	V
$V_{\text{REFL}}$ Input Range		0		$V_{\text{REFH}} - 1.25$	*		*	V
Ref High Input Current		-0.3		1.5	*		*	mA
Ref Low Input Current		-2.0		0	*		*	mA
<b>DYNAMIC PERFORMANCE</b>								
Settling Time <sup>(5)</sup>	To $\pm 0.012\%$ , 10V Output Step		8	10		*	*	$\mu\text{s}$
Channel-to-Channel Crosstalk			0.25			*		LSB
Digital Feedthrough			2				*	nV-s
Output Noise Voltage	$f = 10\text{kHz}$		65			*		$\text{nV}/\sqrt{\text{Hz}}$
<b>DIGITAL INPUT/OUTPUT</b>								
Logic Family			TTL-Compatible CMOS		*			
Logic Levels								
$V_{\text{IH}}$	$I_{\text{IH}} \leq \pm 10\mu\text{A}$	2.4		$V_{\text{DD}} + 0.3$	*		*	V
$V_{\text{IL}}$	$I_{\text{IL}} \leq \pm 10\mu\text{A}$	-0.3		0.8	*		*	V
$V_{\text{OH}}$	$I_{\text{OH}} = -0.8\text{mA}$	3.6		$V_{\text{DD}}$	*		*	V
$V_{\text{OL}}$	$I_{\text{OL}} = 1.6\text{mA}$	0.0		0.4	*		*	V
Data Format			Straight Binary			*		
<b>POWER SUPPLY REQUIREMENTS</b>								
$V_{\text{DD}}$		+4.75		+5.25	*		*	V
$V_{\text{CC}}$		14.25		15.75	*		*	V
$I_{\text{DD}}$			50			*	*	$\mu\text{A}$
$I_{\text{CC}}$			3.0			*	*	mA
Power Dissipation			45			*		mW
<b>TEMPERATURE RANGE</b>								
Specified Performance		-40		+85	*		*	$^{\circ}\text{C}$

NOTES: (1) If  $V_{SS} = 0\text{V}$ , specification applies at code 004<sub>H</sub> and above. (2) LSB means Least Significant Bit, when  $V_{\text{REFH}}$  equals +10V and  $V_{\text{REFL}}$  equals 0V, then one LSB equals 2.44mV. (3) All DAC outputs will match within the specified error band. (4) Ideal output voltage, does not take into account zero or full-scale error. (5) Full-scale positive 10V step and negative step from code FFF<sub>H</sub> to 004<sub>H</sub>.

## ABSOLUTE MAXIMUM RATINGS<sup>(1)</sup>

$V_{CC}$ to $V_{SS}$ .....	-0.3V to +32V
$V_{CC}$ to GND .....	-0.3V to +16V
$V_{SS}$ to GND .....	+0.3V to -16V
$V_{DD}$ to GND .....	-0.3V to 6V
$V_{REFH}$ to GND .....	-9V to +11V
$V_{REFL}$ to GND ( $V_{SS} = -15V$ ) .....	-11V to +9V
$V_{REFL}$ to GND ( $V_{SS} = 0V$ ) .....	-0.3V to +9V
$V_{REFH}$ to $V_{REFL}$ .....	-1V to +22V
Digital Input Voltage to GND .....	-0.3V to $V_{DD} + 0.3V$
Digital Output Voltage to GND .....	-0.3V to $V_{DD} + 0.3V$
Maximum Junction Temperature .....	+150°C
Operating Temperature Range .....	-40°C to +85°C
Storage Temperature Range .....	-65°C to +150°C
Lead Temperature (soldering, 10s) .....	+300°C

NOTE: (1) Stresses above those listed under "Absolute Maximum Ratings" may cause permanent damage to the device. Exposure to absolute maximum conditions for extended periods may affect device reliability.



## ELECTROSTATIC DISCHARGE SENSITIVITY

This integrated circuit can be damaged by ESD. Burr-Brown recommends that all integrated circuits be handled with appropriate precautions. Failure to observe proper handling and installation procedures can cause damage.

ESD damage can range from subtle performance degradation to complete device failure. Precision integrated circuits may be more susceptible to damage because very small parametric changes could cause the device not to meet its published specifications.

## PACKAGE/ORDERING INFORMATION

PRODUCT	MAXIMUM LINEARITY ERROR (LSB)	MAXIMUM DIFFERENTIAL NONLINEARITY ERROR (LSB)	PACKAGE	PACKAGE DRAWING NUMBER	SPECIFICATION TEMPERATURE RANGE	ORDERING NUMBER <sup>(1)</sup>	TRANSPORT MEDIA
DAC7724N	±2	±1	PLCC-28	251	-40°C to +85°C	DAC7724N	Rails
"	"	"	"	"	"	DAC7724N/750	Tape and Reel
DAC7724NB	±1	±1	PLCC-28	251	-40°C to +85°C	DAC7724NB	Rails
"	"	"	"	"	"	DAC7724NB/750	Tape and Reel
DAC7724U	±2	±1	SO-28	217	-40°C to +85°C	DAC7724U	Rails
"	"	"	"	"	"	DAC7724U/1K	Tape and Reel
DAC7724UB	±1	±1	SO-28	217	-40°C to +85°C	DAC7724UB	Rails
"	"	"	"	"	"	DAC7724UB/1K	Tape and Reel
DAC7725N	±2	±1	PLCC-28	251	-40°C to +85°C	DAC7725N	Rails
"	"	"	"	"	"	DAC7725N/750	Tape and Reel
DAC7725NB	±1	±1	PLCC-28	251	-40°C to +85°C	DAC7725NB	Rails
"	"	"	"	"	"	DAC7725NB/750	Tape and Reel
DAC7725U	±2	±1	SO-28	217	-40°C to +85°C	DAC7725U	Rails
"	"	"	"	"	"	DAC7725U/1K	Tape and Reel
DAC7725UB	±1	±1	SO-28	217	-40°C to +85°C	DAC7725UB	Rails
"	"	"	"	"	"	DAC7725UB/1K	Tape and Reel

NOTE: (1) Models with a slash (/) are available only in Tape and Reel in the quantities indicated (e.g., /750 indicates 750 devices per reel). Ordering 750 pieces of "DAC7724/750" will get a single 750-piece Tape and Reel.

## ESD PROTECTION CIRCUITS

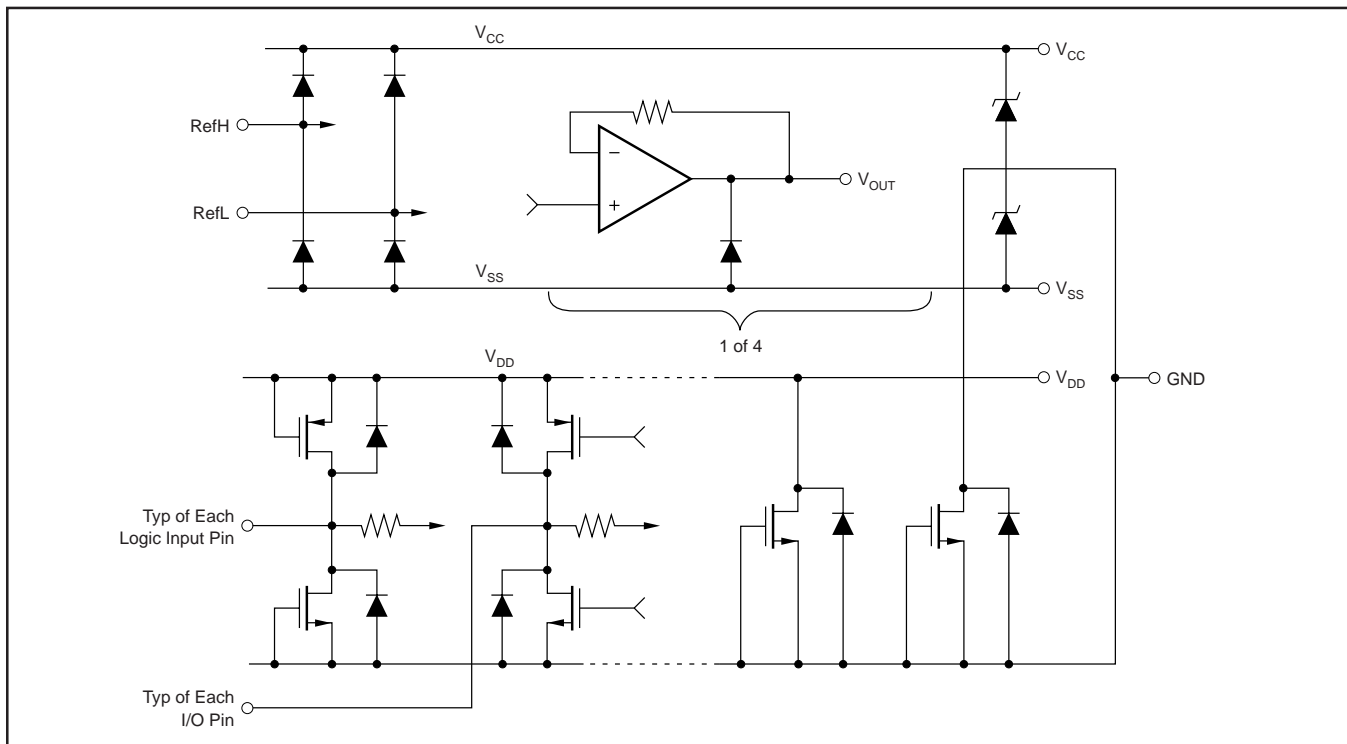

## PIN CONFIGURATIONS

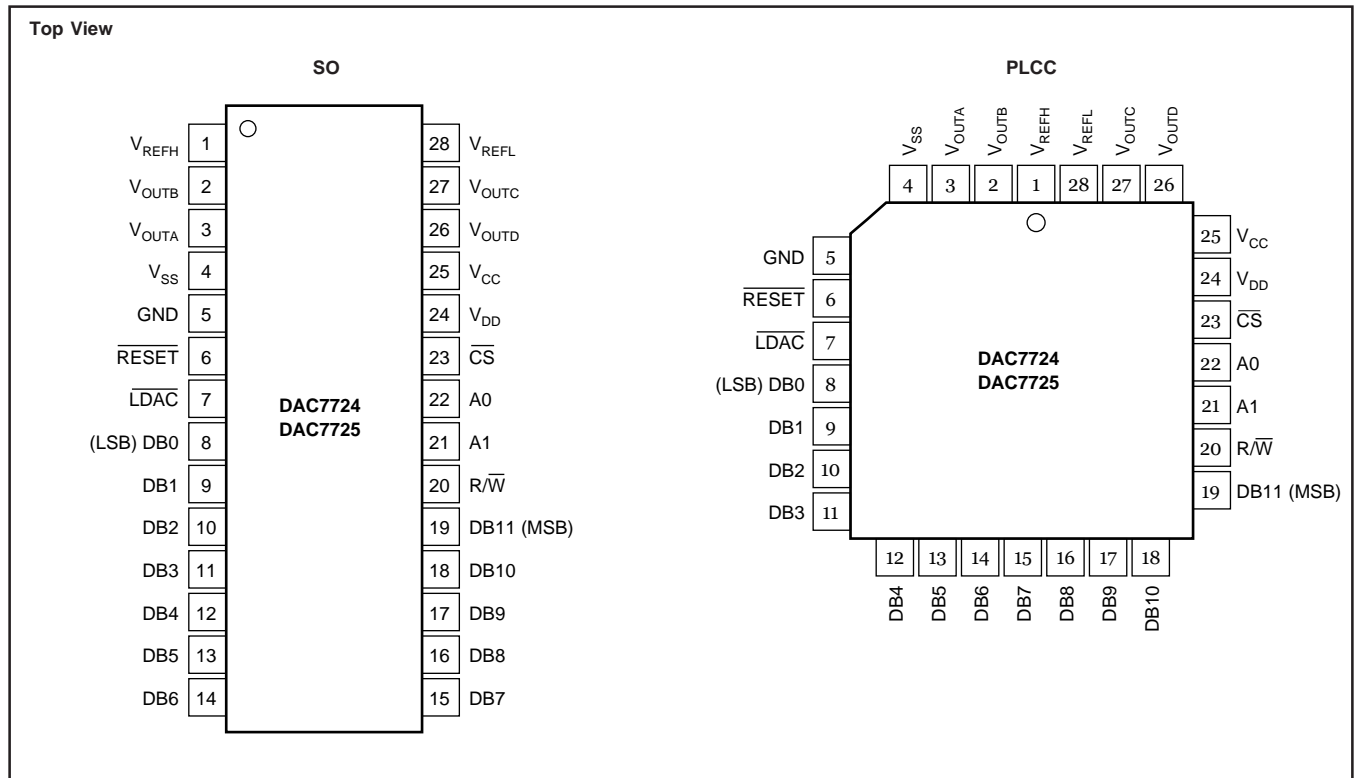

## PIN DESCRIPTIONS

PIN	NAME	DESCRIPTION
1	V <sub>REFH</sub>	Reference Input Voltage High. Sets maximum output voltage for all DACs.
2	V <sub>OUTB</sub>	DAC B Voltage Output.
3	V <sub>OUTA</sub>	DAC A Voltage Output.
4	V <sub>SS</sub>	Negative Analog Supply Voltage, 0V or -15V.
5	GND	Ground.
6	RESET	Asynchronous Reset Input. Sets DAC and input registers to either mid-scale (800 <sub>H</sub> , DAC7724) or zero-scale (000 <sub>H</sub> , DAC7725) when LOW.
7	LDAC	Load DAC Input. All DAC Registers are transparent when LOW.
8	DB0	Data Bit 0. Least significant bit of 12-bit word.
9	DB1	Data Bit 1
10	DB2	Data Bit 2
11	DB3	Data Bit 3
12	DB4	Data Bit 4
13	DB5	Data Bit 5
14	DB6	Data Bit 6
15	DB7	Data Bit 7
16	DB8	Data Bit 8
17	DB9	Data Bit 9
18	DB10	Data Bit 10
19	DB11	Data Bit 11. Most significant bit of 12-bit word.
20	R/W	Read/Write Control Input (read = HIGH, write = LOW).
21	A1	Register/DAC Select (C or D = HIGH, A or B = LOW).
22	A0	Register/DAC Select (B or D = HIGH, A or C = LOW).
23	C <sub>S</sub>	Chip Select Input.
24	V <sub>DD</sub>	Positive Digital Supply, +5V.
25	V <sub>CC</sub>	Positive Analog Supply Voltage, +15V nominal.
26	V <sub>OUTD</sub>	DAC D Voltage Output.
27	V <sub>OUTC</sub>	DAC C Voltage Output.
28	V <sub>REFL</sub>	Reference Input Voltage Low. Sets minimum output voltage for all DACs.

# TYPICAL PERFORMANCE CURVES: $V_{SS} = 0V$

At  $T_A = +25^\circ C$ ,  $V_{CC} = +15V$ ,  $V_{DD} = +5V$ ,  $V_{SS} = 0V$ ,  $V_{REFH} = +10V$ ,  $V_{REFL} = 0V$ , representative unit, unless otherwise specified.

LINEARITY ERROR AND  
DIFFERENTIAL LINEARITY ERROR vs CODE  
**Single Channel 25°C**  
(Typical of Each Output Channel)

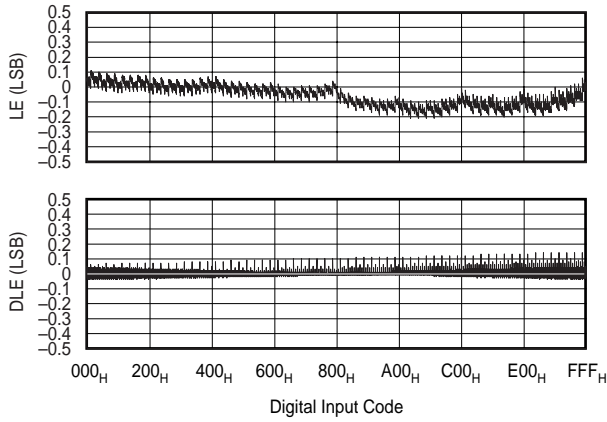

LINEARITY ERROR AND  
DIFFERENTIAL LINEARITY ERROR vs CODE  
**Single Channel 85°C**  
(Typical of Each Output Channel)

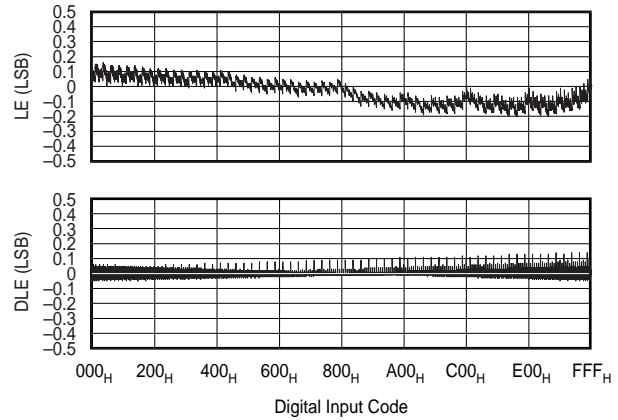

LINEARITY ERROR AND  
DIFFERENTIAL LINEARITY ERROR vs CODE  
**Single Channel -40°C**  
(Typical of Each Output Channel)

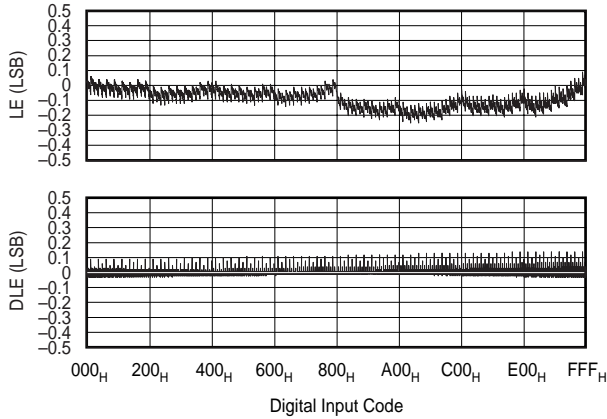

ZERO-SCALE ERROR vs TEMPERATURE  
(Code 004<sub>H</sub>)

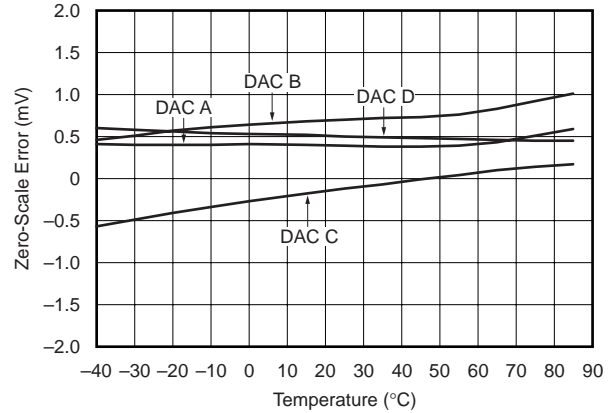

FULL-SCALE ERROR vs TEMPERATURE  
(Code FFF<sub>H</sub>)

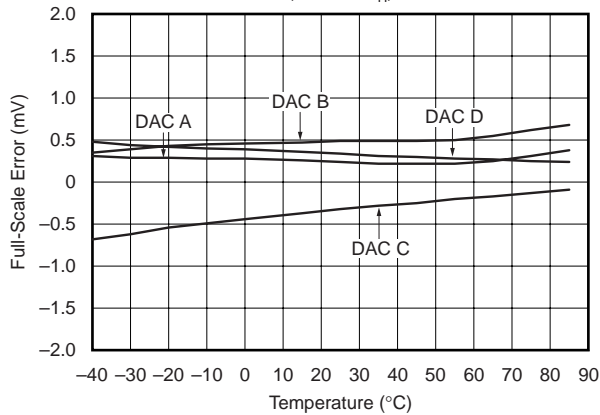

CURRENT vs CODE  
All DACs Sent to Indicated Code

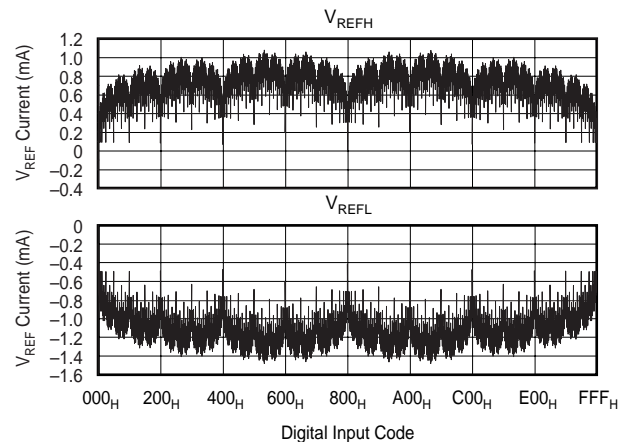

# TYPICAL PERFORMANCE CURVES: $V_{SS} = 0V$ (Cont.)

At  $T_A = +25^\circ C$ ,  $V_{CC} = +15V$ ,  $V_{DD} = +5V$ ,  $V_{SS} = 0V$ ,  $V_{REFH} = +10V$ ,  $V_{REFL} = 0V$ , representative unit, unless otherwise specified.

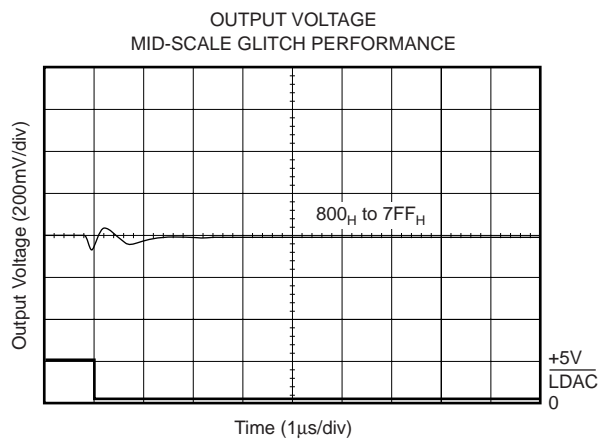
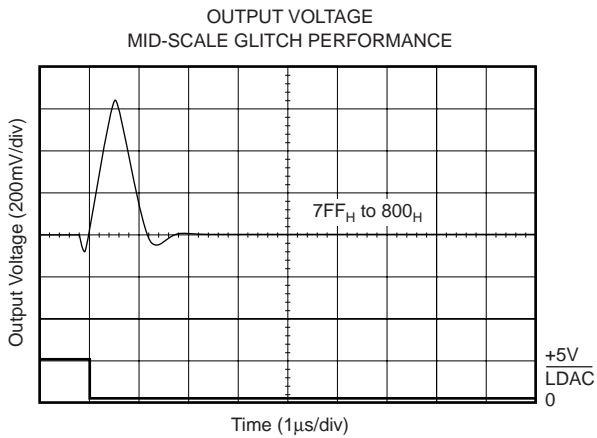
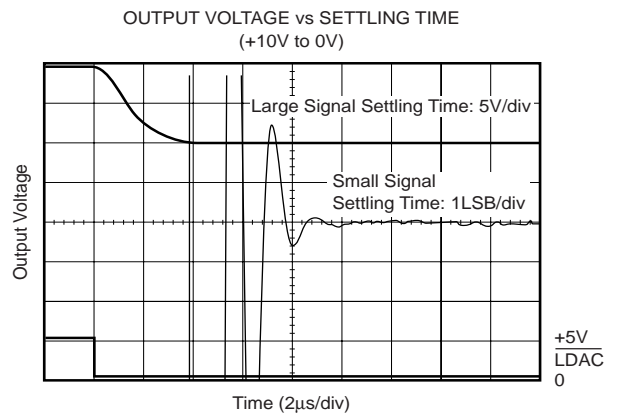
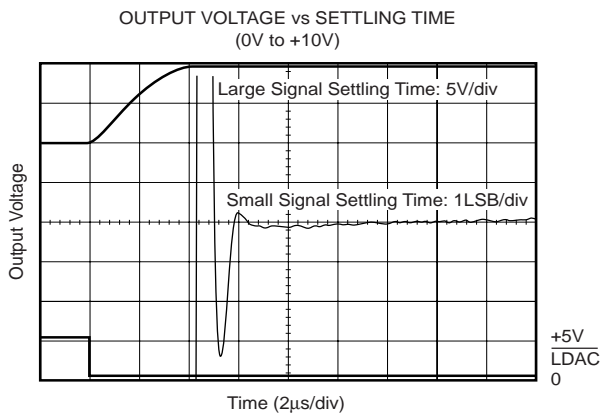
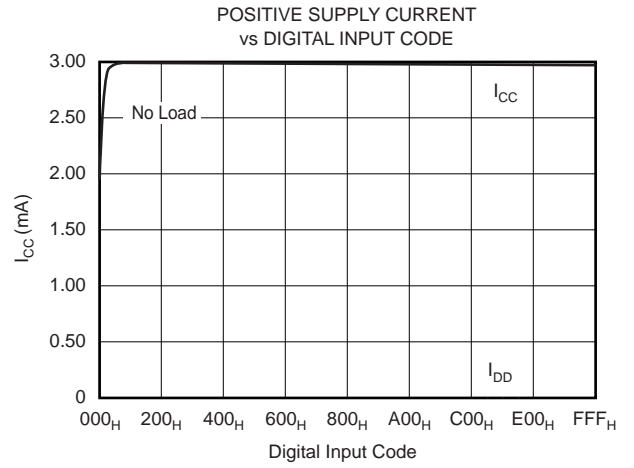
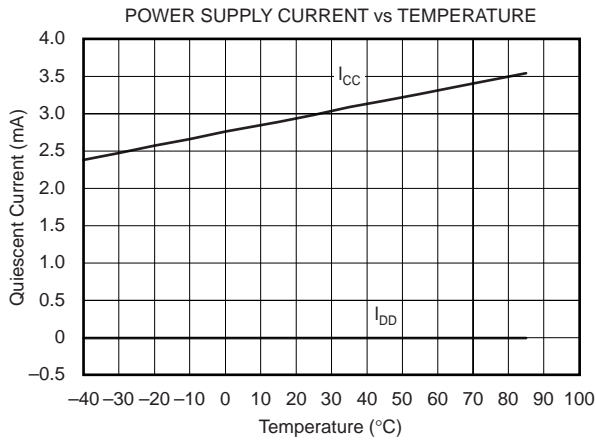

# TYPICAL PERFORMANCE CURVES: $V_{SS} = 0V$ (Cont.)

At  $T_A = +25^\circ C$ ,  $V_{CC} = +15V$ ,  $V_{DD} = +5V$ ,  $V_{SS} = 0V$ ,  $V_{REFH} = +10V$ ,  $V_{REFL} = 0V$ , representative unit, unless otherwise specified.

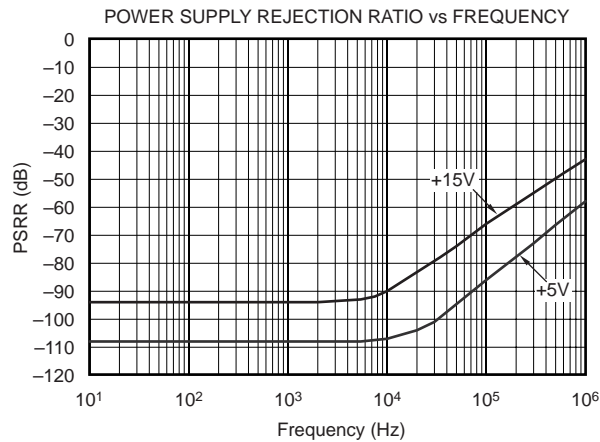
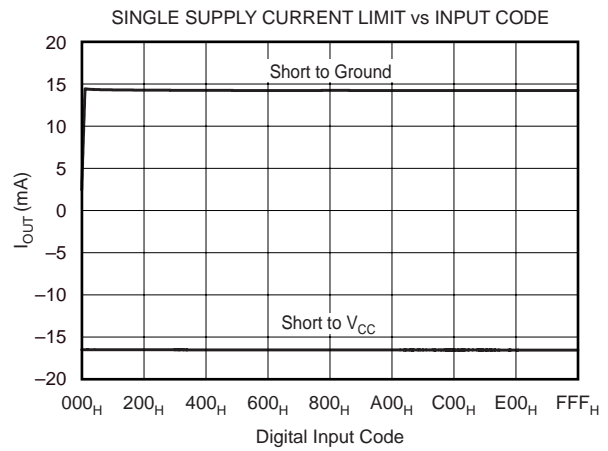
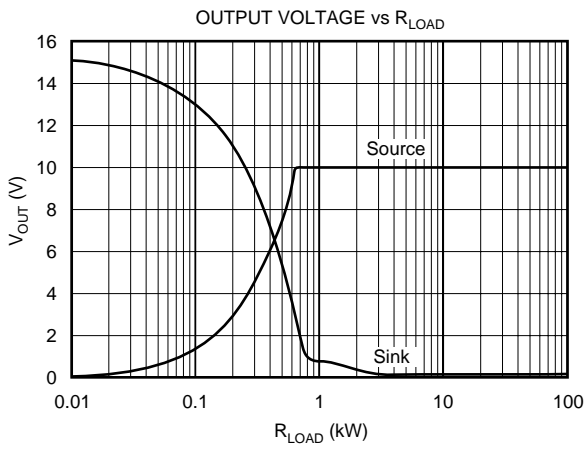
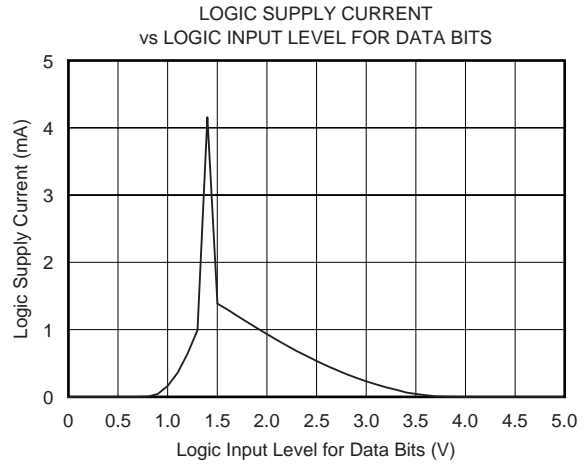
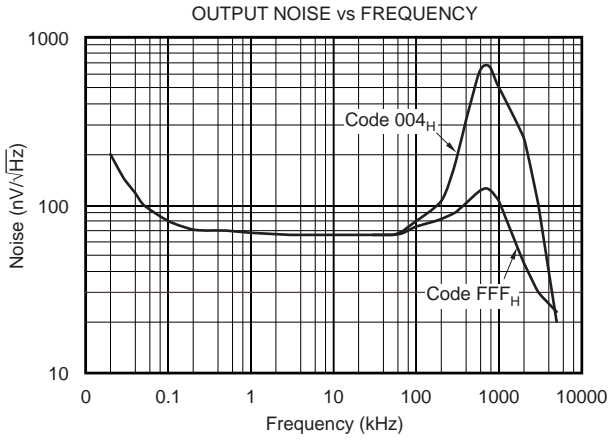

# TYPICAL PERFORMANCE CURVES: $V_{SS} = -15V$

At  $T_A = +25^\circ C$ ,  $V_{CC} = +15V$ ,  $V_{DD} = +5V$ ,  $V_{SS} = -15V$ ,  $V_{REFH} = +10V$ ,  $V_{REFL} = -10V$ , representative unit, unless otherwise specified.

LINEARITY ERROR AND  
DIFFERENTIAL LINEARITY ERROR vs CODE  
**Single Channel 25°C**  
(Typical of Each Output Channel)

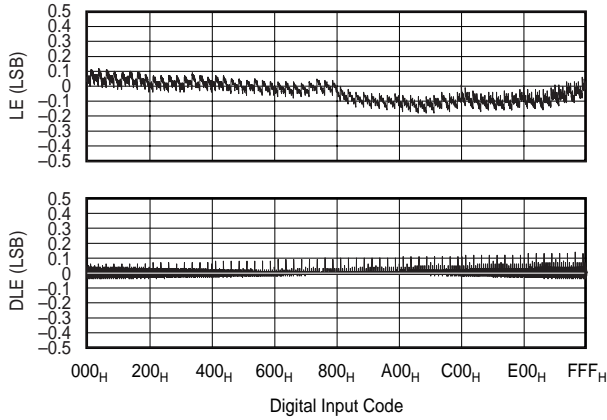

LINEARITY ERROR AND  
DIFFERENTIAL LINEARITY ERROR vs CODE  
**Single Channel 85°C**  
(Typical of Each Output Channel)

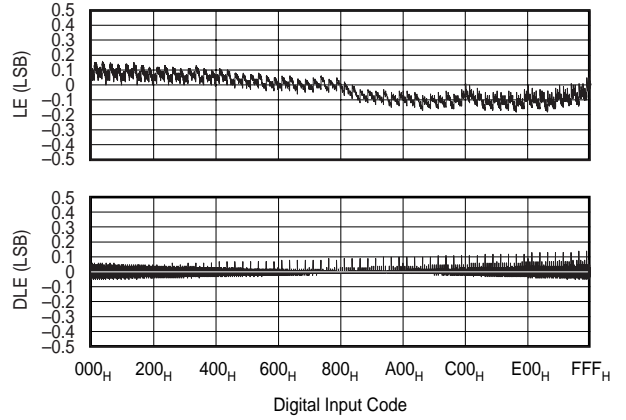

LINEARITY ERROR AND  
DIFFERENTIAL LINEARITY ERROR vs CODE  
**Single Channel -40°C**  
(Typical of Each Output Channel)

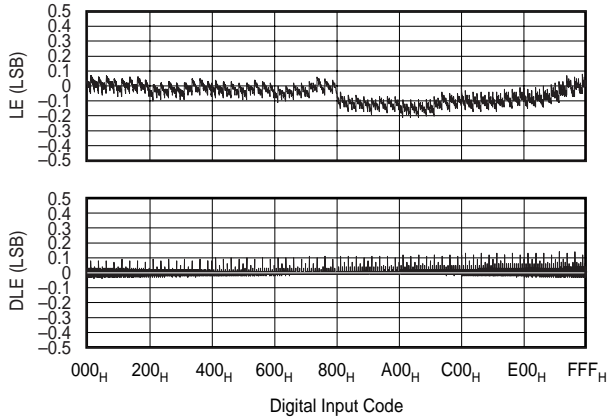

CURRENT vs CODE  
All DACs Sent to Indicated Code

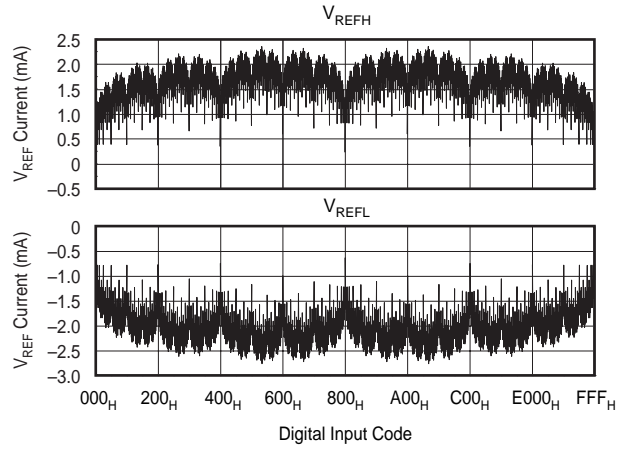

BIPOLAR ZERO-SCALE ERROR vs TEMPERATURE  
(Code 800<sub>H</sub>)

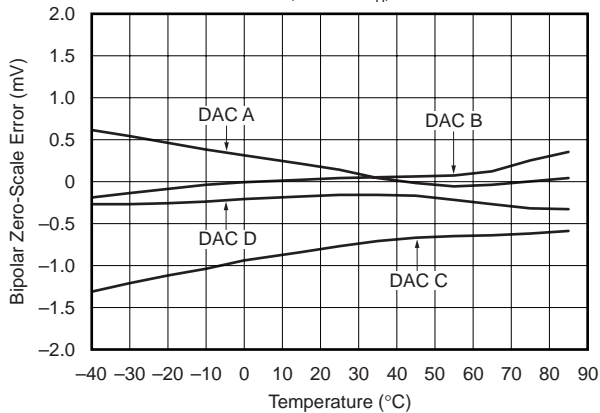

POSITIVE FULL-SCALE ERROR vs TEMPERATURE  
(Code FFF<sub>H</sub>)

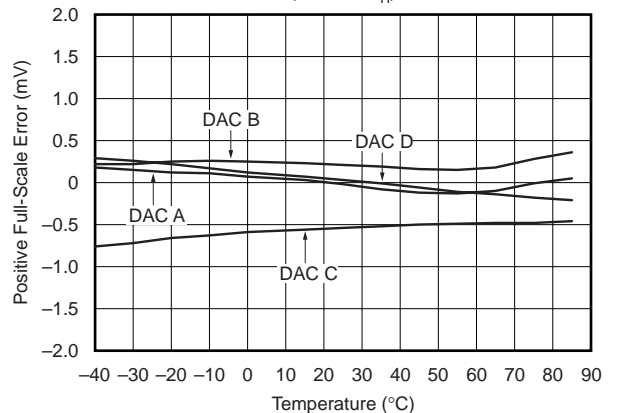

# TYPICAL PERFORMANCE CURVES: $V_{SS} = -15V$ (Cont.)

At  $T_A = +25^\circ C$ ,  $V_{CC} = +15V$ ,  $V_{DD} = +5V$ ,  $V_{SS} = -15V$ ,  $V_{REFH} = +10V$ ,  $V_{REFL} = -10V$ , representative unit, unless otherwise specified.

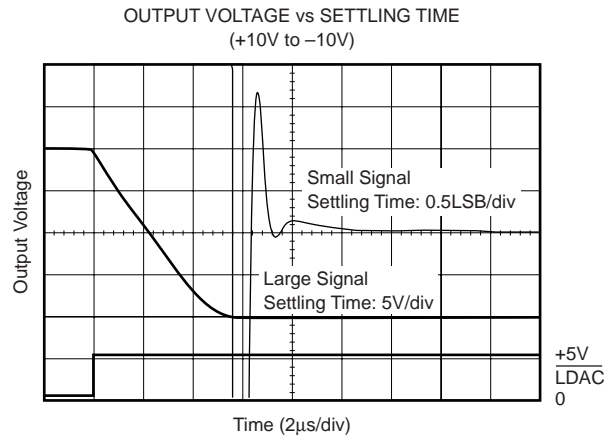
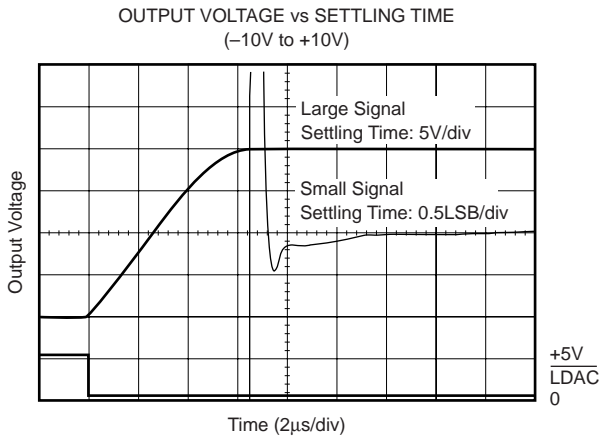
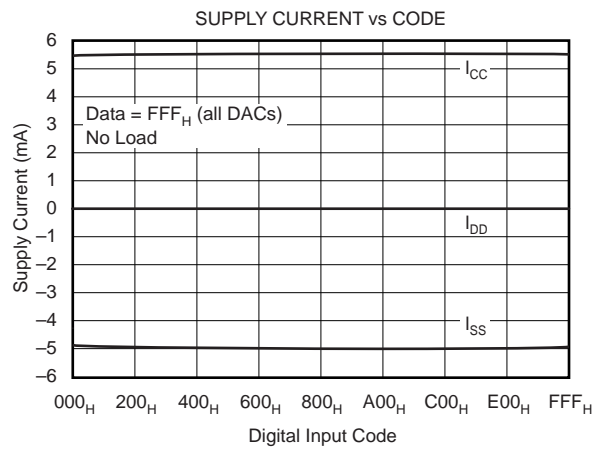
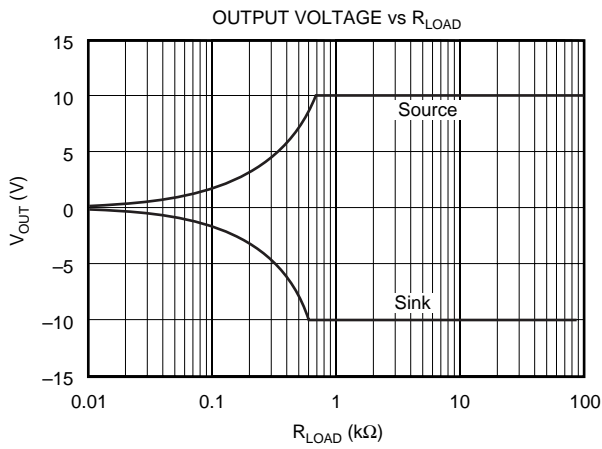
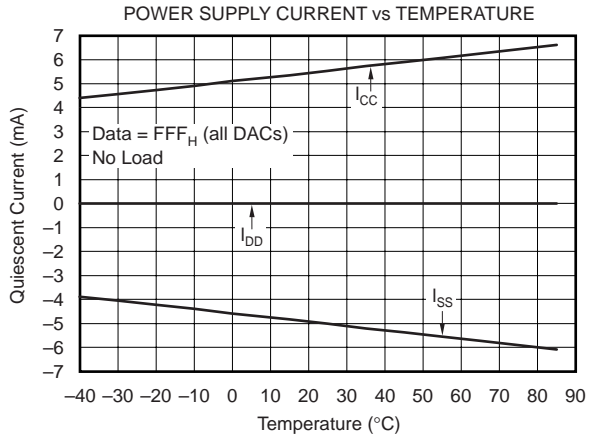
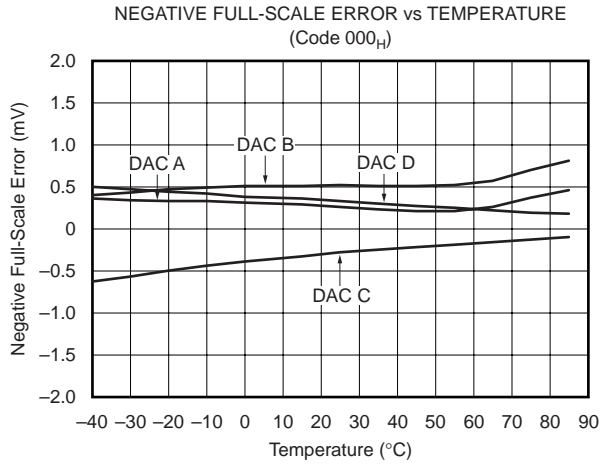

# TYPICAL PERFORMANCE CURVES: $V_{SS} = -15V$ (Cont.)

At  $T_A = +25^\circ C$ ,  $V_{CC} = +15V$ ,  $V_{DD} = +5V$ ,  $V_{SS} = -15V$ ,  $V_{REFH} = +10V$ ,  $V_{REFL} = -10V$ , representative unit, unless otherwise specified.

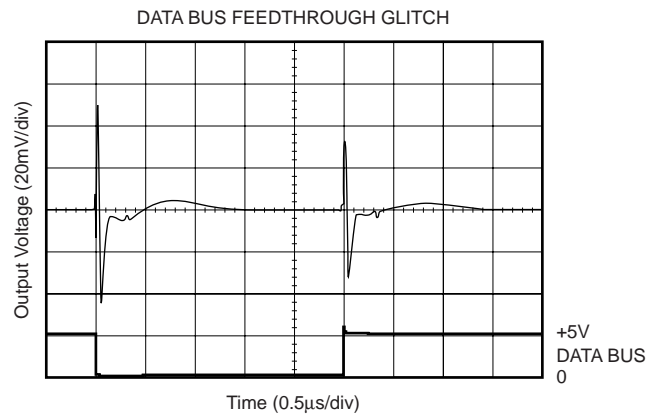
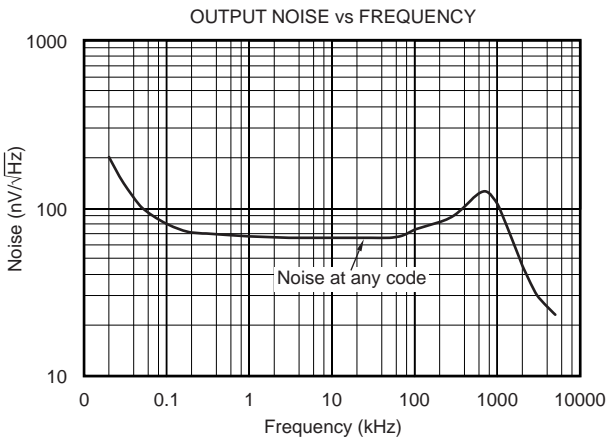
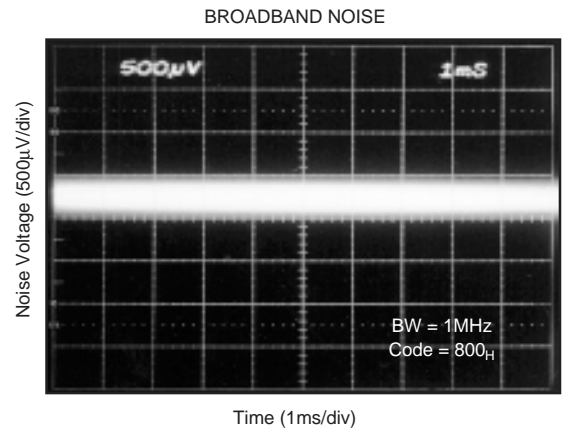
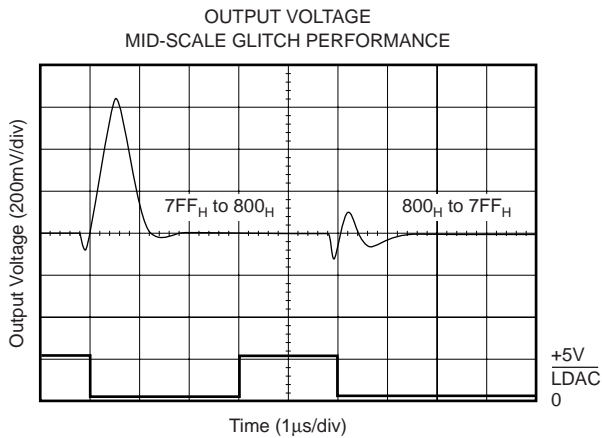
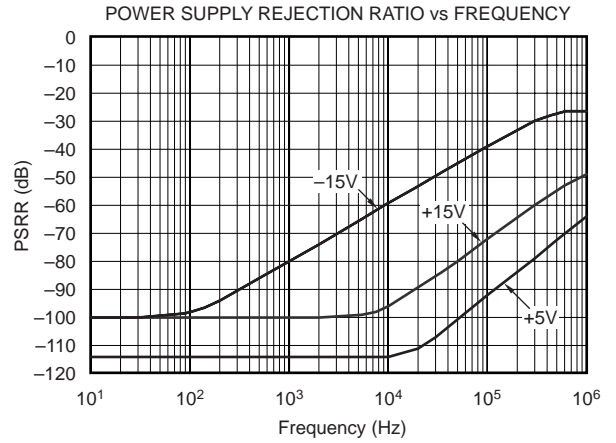
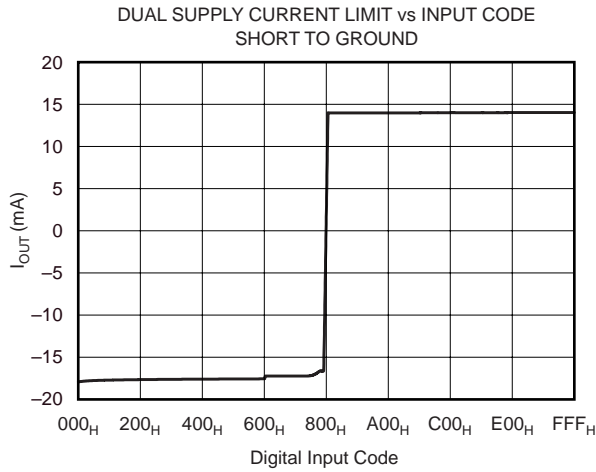

# THEORY OF OPERATION

The DAC7724 and DAC7725 are quad voltage output, 12-bit digital-to-analog converters (DACs). The architecture is a classic R-2R ladder configuration followed by an operational amplifier that serves as a buffer, as shown in Figure 1. Each DAC has its own R-2R ladder network and output op-amp, but all share the reference voltage inputs. The minimum voltage output (“zero-scale”) and maximum voltage

output (“full-scale”) are set by the external voltage references ( $V_{REFL}$  and  $V_{REFH}$ , respectively). The digital input is a 12-bit parallel word and the DAC input registers offer a readback capability. The converters can be powered from a single +15V supply or a dual  $\pm 15V$  supply. Each device offers a reset function which immediately sets all DAC registers and DAC output voltages to mid-scale (DAC7724, code 800<sub>H</sub>) or to zero-scale (DAC7725, code 000<sub>H</sub>). See Figures 2 and 3 for the basic operation of the DAC7724/25.

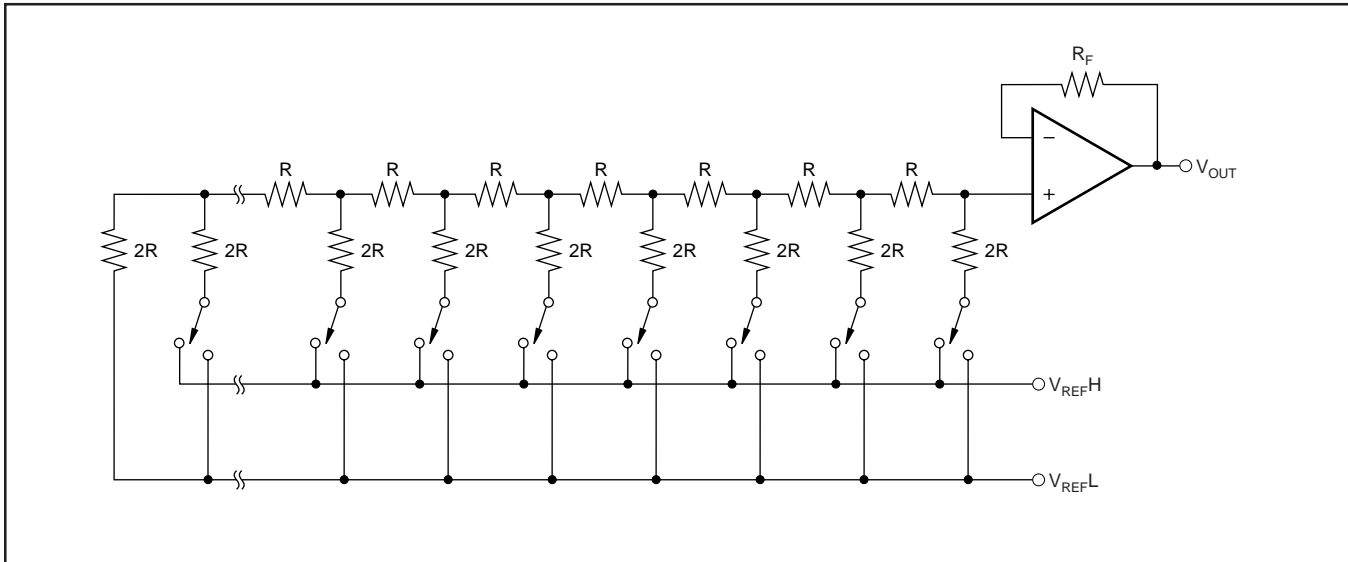

FIGURE 1. DAC7724/25 Architecture.

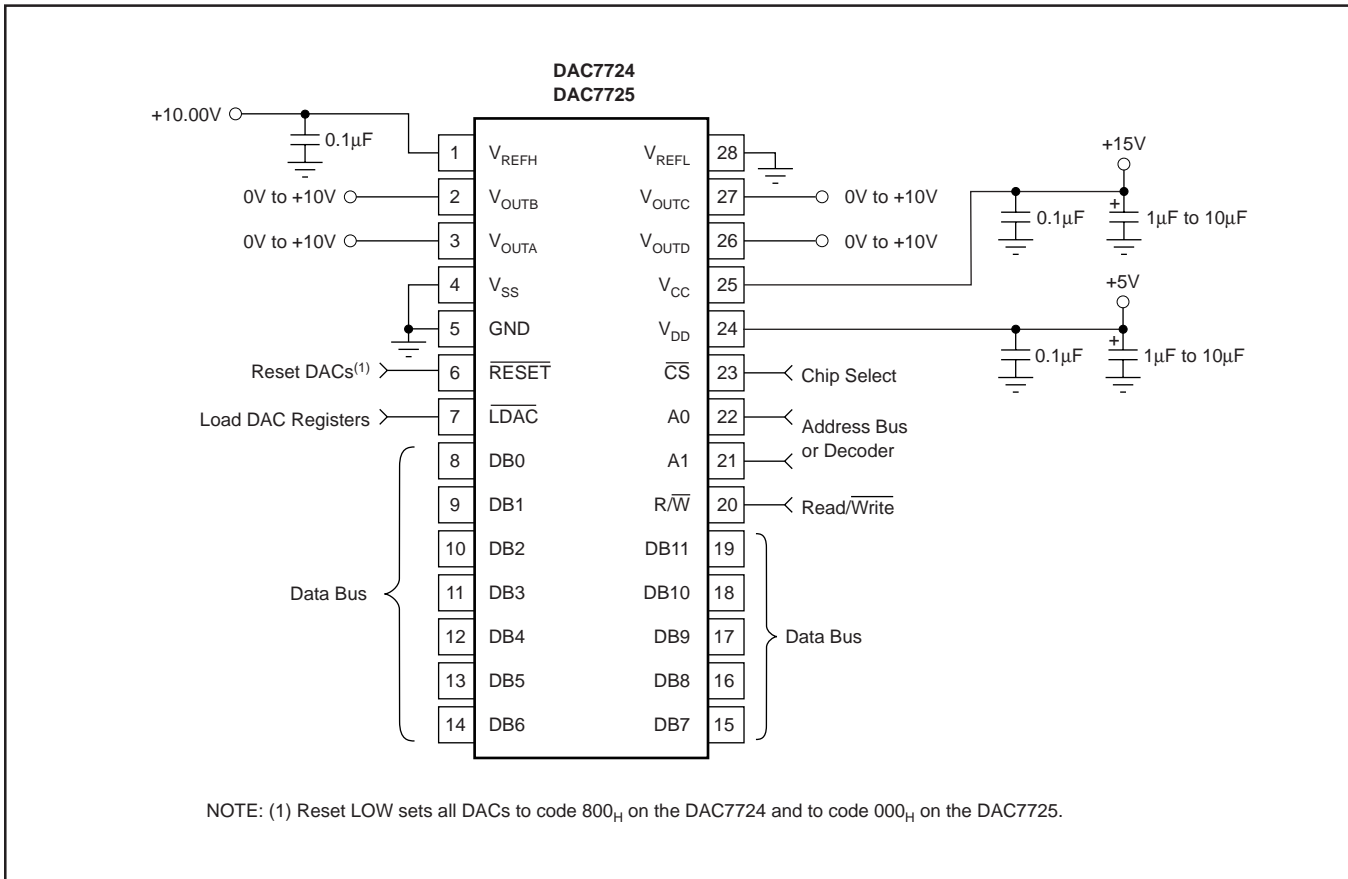

FIGURE 2. Basic Single-Supply Operation of the DAC7724/25.

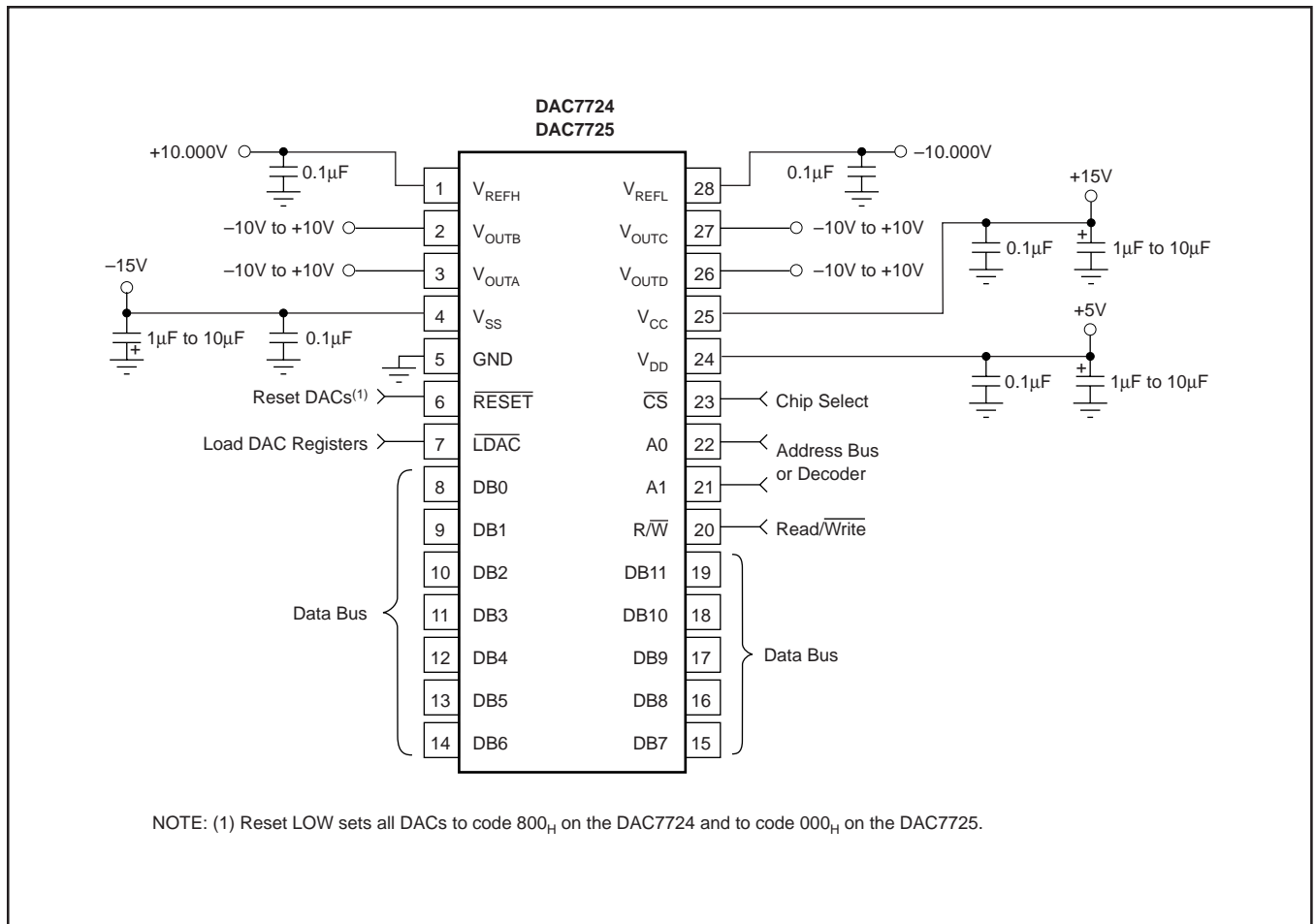

FIGURE 3. Basic Dual-Supply Operation of the DAC7724/25.

## ANALOG OUTPUTS

When  $V_{SS} = -15V$  (dual supply operation), the output amplifier can swing to within 4V of the supply rails, guaranteed over the  $-40^{\circ}C$  to  $+85^{\circ}C$  temperature range. With  $V_{SS} = 0V$  (single-supply operation) and  $R_{LOAD}$  connected to ground, the output can swing to ground. Note that the settling time of the output op-amp will be longer with voltages very near ground. Additionally, care must be taken when measuring the zero-scale error when  $V_{SS} = 0V$ . Since the output voltage cannot swing below ground, the output voltage may not change for the first few digital input codes ( $000_H$ ,  $001_H$ ,  $002_H$ , etc.) if the output amplifier has a negative offset. At the negative offset limit of  $-4$  LSB ( $-9.76mV$ ), for the single-supply case, the first specified output starts at code  $004_H$ .

## REFERENCE INPUTS

For dual-supply operation, the reference inputs,  $V_{REFL}$  and  $V_{REFH}$ , can be any voltage between  $V_{SS} + 4V$  and  $V_{CC} - 4V$  provided that  $V_{REFH}$  is at least 1.25V greater than  $V_{REFL}$ . For single-supply operation ( $V_{SS} = 0V$ ),  $V_{REFL}$  value can be above 0V, with the same provision that  $V_{REFH}$  is at least 1.25V greater than  $V_{REFL}$ . The minimum output of each DAC is equal to  $V_{REFL}$  plus a small offset voltage (essen-

tially, the offset of the output op-amp). The maximum output is equal to  $V_{REFH}$  plus a similar offset voltage. Note that  $V_{SS}$  (the negative power supply) must either be connected to ground or must be in the range of  $-14.25V$  to  $-15.75V$ . The voltage on  $V_{SS}$  sets several bias points within the converter, if  $V_{SS}$  is not in one of these two configurations, the bias values may be in error and proper operation of the device is not guaranteed.

The current into the  $V_{REFH}$  input and out of  $V_{REFL}$  depends on the DAC output voltages and can vary from a few microamps to approximately 0.3mA. The reference input appears as a varying load to the reference. If the reference can sink or source the required current, a reference buffer is not required. See "Reference Current vs Code" in the Typical Performance Curves.

The analog supplies (or the analog supplies and the reference power supplies) have to come up first. If the power supplies for the references come up first, then the  $V_{CC}$  and  $V_{SS}$  supplies will be "powered from the reference via the ESD protection diodes" (see page 4).

Bypassing the reference voltage or voltages with at least a 0.1µF capacitor placed as close to the DAC7724/25 package is strongly recommended.

## DIGITAL INTERFACE

Table I shows the basic control logic for the DAC7724/25. Note that each internal register is level triggered and not edge triggered. When the appropriate signal is LOW, the register becomes transparent. When this signal is returned HIGH, the digital word currently in the register is latched. The first set of registers (the Input Registers) are triggered via the A0, A1,  $\overline{R/W}$ , and  $\overline{CS}$  inputs. Only one of these registers is transparent at any given time. The second set of registers (the DAC Registers) are all transparent when  $\overline{LDAC}$  input is pulled LOW.

Each DAC can be updated independently by writing to the appropriate Input Register and then updating the DAC Register. Alternatively, the entire DAC Register set can be configured as always transparent by keeping  $\overline{LDAC}$  LOW—the DAC update will occur when the Input Register is written.

The double buffered architecture is mainly designed so that each DAC Input Register can be written at any time and then all DAC output voltages updated simultaneously by pulling  $\overline{LDAC}$  LOW. It also allows a DAC Input Register to be written to at any point and the DAC voltage to be synchronously changed via a trigger signal connected to  $\overline{LDAC}$ .

## DIGITAL TIMING

Figure 4 and Table II provide detailed timing for the digital interface of the DAC7724 and DAC7725.

## DIGITAL INPUT CODING

The DAC7724 and DAC7725 input data is in straight binary format. The output voltage is given by the following equation:

$$V_{OUT} = V_{REFL} + \frac{(V_{REFH} - V_{REFL}) \cdot N}{4096}$$

where N is the digital input code. This equation does not include the effects of offset (zero-scale) errors.

A1	A0	$\overline{R/W}$	$\overline{CS}$	$\overline{RESET}$	$\overline{LDAC}$	SELECTED INPUT REGISTER	STATE OF SELECTED INPUT REGISTER	STATE OF ALL DAC REGISTERS
L <sup>(1)</sup>	L	L	L	H <sup>(2)</sup>	L	A	Transparent	Transparent
L	H	L	L	H	L	B	Transparent	Transparent
H	L	L	L	H	L	C	Transparent	Transparent
H	H	L	L	H	L	D	Transparent	Transparent
L	L	L	L	H	H	A	Transparent	Latched
L	H	L	L	H	H	B	Transparent	Latched
H	L	L	L	H	H	C	Transparent	Latched
H	H	L	L	H	H	D	Transparent	Latched
L	L	H	L	H	H	A	Readback	Latched
L	H	H	L	H	H	B	Readback	Latched
H	L	H	L	H	H	C	Readback	Latched
H	H	H	L	H	H	D	Readback	Latched
X <sup>(3)</sup>	X	X	H	H	L	NONE	(All Latched)	Transparent
X	X	X	H	H	H	NONE	(All Latched)	Latched
X	X	X	X	L	X	ALL	Reset <sup>(4)</sup>	Reset <sup>(4)</sup>

NOTES: (1) L = Logic LOW. (2) H= Logic HIGH. (3) X = Don't Care. (4) DAC7724 resets to 800<sub>H</sub>, DAC7725 resets to 000<sub>H</sub>. When  $\overline{RESET}$  rises, all registers that are in their latched state retain the reset value.

TABLE I. DAC7724 and DAC7725 Control Logic Truth Table.

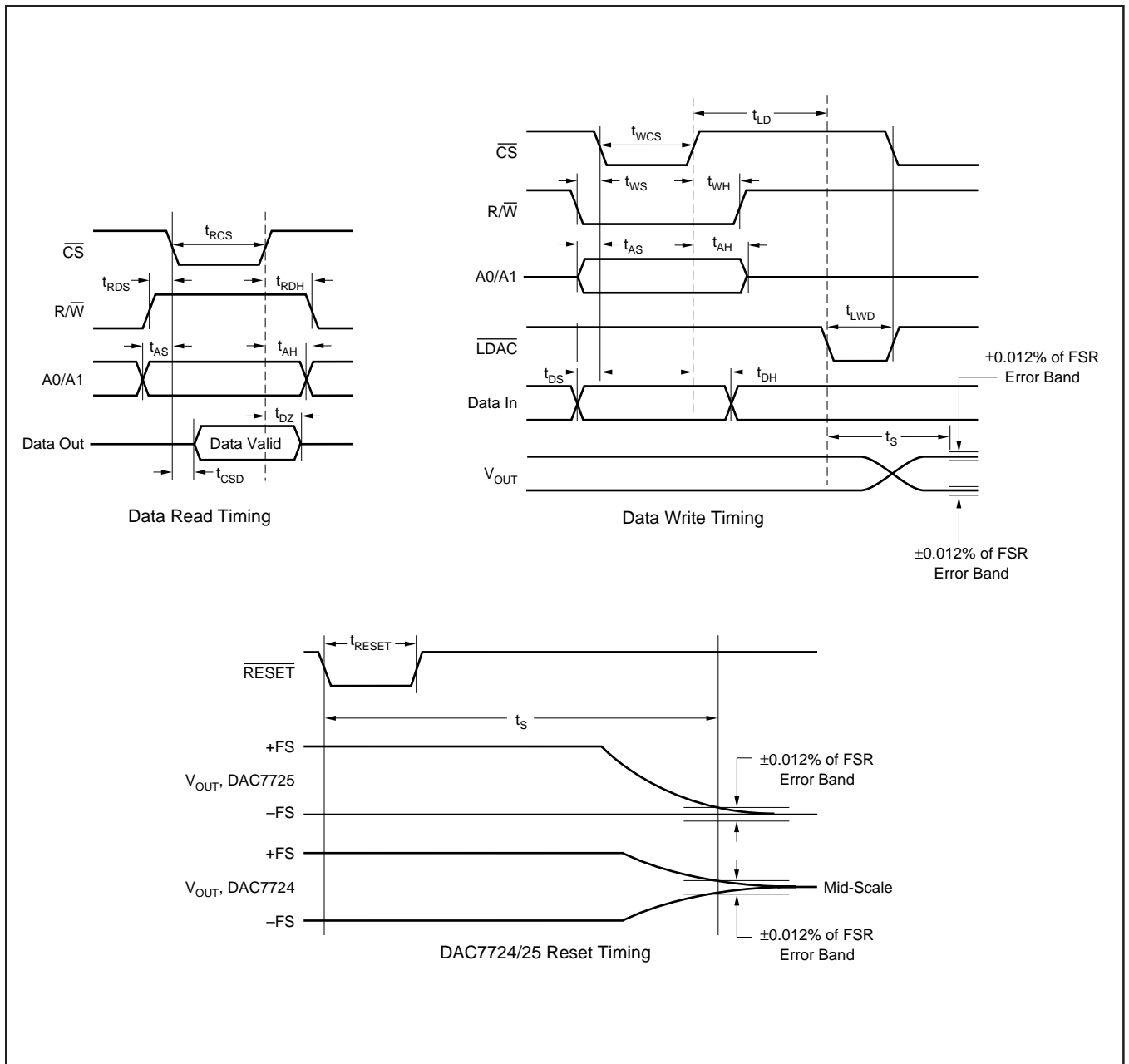

FIGURE 4. Digital Input and Output Timing.

SYMBOL	DESCRIPTION	MIN	TYP	MAX	UNITS
$t_{RCS}$	$\overline{CS}$ LOW for Read	200			ns
$t_{RDS}$	R/W HIGH to $\overline{CS}$ LOW	10			ns
$t_{RDH}$	R/W HIGH after $\overline{CS}$ HIGH	10			ns
$t_{DZ}$	$\overline{CS}$ HIGH to Data Bus in High Impedance		100		ns
$t_{CSD}$	$\overline{CS}$ LOW to Data Bus Valid		100	160	ns
$t_{WCS}$	$\overline{CS}$ LOW for Write	50			ns
$t_{WS}$	R/W LOW to $\overline{CS}$ LOW	0			ns
$t_{WH}$	R/W LOW after $\overline{CS}$ HIGH	0			ns
$t_{AS}$	Address Valid to $\overline{CS}$ LOW	0			ns
$t_{AH}$	Address Valid after $\overline{CS}$ HIGH	0			ns
$t_{LD}$	LDAC Delay from $\overline{CS}$ HIGH	10			ns
$t_{DS}$	Data Valid to $\overline{CS}$ LOW	0			ns
$t_{DH}$	Data Valid after $\overline{CS}$ HIGH	0			ns
$t_{LWD}$	LDAC LOW	50			ns
$t_{RESET}$	RESET LOW Time	50			ns
$t_s$	Settling Time			10	$\mu$ s

TABLE II. Timing Specifications ( $T_A = -40^\circ\text{C}$  to  $+85^\circ\text{C}$ ).

**PACKAGING INFORMATION**

Orderable Device	Status (1)	Package Type	Package Drawing	Pins	Package Qty	Eco Plan (2)	Lead/Ball Finish (6)	MSL Peak Temp (3)	Op Temp (°C)	Device Marking (4/5)	Samples
DAC7724N	ACTIVE	PLCC	FN	28	37	Green (RoHS & no Sb/Br)	CU NIPDAU	Level-3-245C-168 HR	-40 to 85	DAC7724N	<a href="#">Samples</a>
DAC7724NB	ACTIVE	PLCC	FN	28	37	Green (RoHS & no Sb/Br)	CU NIPDAU	Level-3-245C-168 HR	-40 to 85	DAC7724N B	<a href="#">Samples</a>
DAC7724NB/750	ACTIVE	PLCC	FN	28	750	Green (RoHS & no Sb/Br)	CU NIPDAU	Level-3-245C-168 HR	-40 to 85	DAC7724N B	<a href="#">Samples</a>
DAC7724NB/750G4	ACTIVE	PLCC	FN	28	750	Green (RoHS & no Sb/Br)	CU NIPDAU	Level-3-245C-168 HR	-40 to 85	DAC7724N B	<a href="#">Samples</a>
DAC7724U	ACTIVE	SOIC	DW	28	20	Green (RoHS & no Sb/Br)	CU NIPDAU	Level-3-260C-168 HR	-40 to 85	DAC7724U B	<a href="#">Samples</a>
DAC7724U/1K	ACTIVE	SOIC	DW	28	1000	Green (RoHS & no Sb/Br)	CU NIPDAU	Level-3-260C-168 HR	-40 to 85	DAC7724U B	<a href="#">Samples</a>
DAC7724UB	ACTIVE	SOIC	DW	28	20	Green (RoHS & no Sb/Br)	CU NIPDAU	Level-3-260C-168 HR	-40 to 85	DAC7724U B	<a href="#">Samples</a>
DAC7724UB/1K	ACTIVE	SOIC	DW	28	1000	Green (RoHS & no Sb/Br)	CU NIPDAU	Level-3-260C-168 HR	-40 to 85	DAC7724U B	<a href="#">Samples</a>
DAC7725N	LIFEBUY	PLCC	FN	28	37	Green (RoHS & no Sb/Br)	CU NIPDAU	Level-3-245C-168 HR	-40 to 85	DAC7725N	
DAC7725NB	ACTIVE	PLCC	FN	28	37	Green (RoHS & no Sb/Br)	CU NIPDAU	Level-3-245C-168 HR	-40 to 85	DAC7725N B	<a href="#">Samples</a>
DAC7725NB/750	ACTIVE	PLCC	FN	28	750	Green (RoHS & no Sb/Br)	CU NIPDAU	Level-3-245C-168 HR	-40 to 85	DAC7725N B	<a href="#">Samples</a>
DAC7725NB/750G4	ACTIVE	PLCC	FN	28	750	Green (RoHS & no Sb/Br)	CU NIPDAU	Level-3-245C-168 HR	-40 to 85	DAC7725N B	<a href="#">Samples</a>
DAC7725U	ACTIVE	SOIC	DW	28	20	Green (RoHS & no Sb/Br)	CU NIPDAU	Level-3-260C-168 HR	-40 to 85	DAC7725U B	<a href="#">Samples</a>
DAC7725UB	ACTIVE	SOIC	DW	28	20	Green (RoHS & no Sb/Br)	CU NIPDAU	Level-3-260C-168 HR	-40 to 85	DAC7725U B	<a href="#">Samples</a>
DAC7725UB/1K	ACTIVE	SOIC	DW	28	1000	Green (RoHS & no Sb/Br)	CU NIPDAU	Level-3-260C-168 HR	-40 to 85	DAC7725U B	<a href="#">Samples</a>
DAC7725UB/1KG4	ACTIVE	SOIC	DW	28	1000	Green (RoHS & no Sb/Br)	CU NIPDAU	Level-3-260C-168 HR	-40 to 85	DAC7725U B	<a href="#">Samples</a>
DAC7725UBG4	ACTIVE	SOIC	DW	28	20	Green (RoHS & no Sb/Br)	CU NIPDAU	Level-3-260C-168 HR	-40 to 85	DAC7725U B	<a href="#">Samples</a>

Orderable Device	Status (1)	Package Type	Package Drawing	Pins	Package Qty	Eco Plan (2)	Lead/Ball Finish (6)	MSL Peak Temp (3)	Op Temp (°C)	Device Marking (4/5)	Samples
DAC7725UG4	ACTIVE	SOIC	DW	28	20	Green (RoHS & no Sb/Br)	CU NIPDAU	Level-3-260C-168 HR	-40 to 85	DAC7725U B	<b>Samples</b>

(1) The marketing status values are defined as follows:

**ACTIVE:** Product device recommended for new designs.

**LIFEBUY:** TI has announced that the device will be discontinued, and a lifetime-buy period is in effect.

**NRND:** Not recommended for new designs. Device is in production to support existing customers, but TI does not recommend using this part in a new design.

**PREVIEW:** Device has been announced but is not in production. Samples may or may not be available.

**OBSOLETE:** TI has discontinued the production of the device.

(2) **RoHS:** TI defines "RoHS" to mean semiconductor products that are compliant with the current EU RoHS requirements for all 10 RoHS substances, including the requirement that RoHS substance do not exceed 0.1% by weight in homogeneous materials. Where designed to be soldered at high temperatures, "RoHS" products are suitable for use in specified lead-free processes. TI may reference these types of products as "Pb-Free".

**RoHS Exempt:** TI defines "RoHS Exempt" to mean products that contain lead but are compliant with EU RoHS pursuant to a specific EU RoHS exemption.

**Green:** TI defines "Green" to mean the content of Chlorine (Cl) and Bromine (Br) based flame retardants meet JS709B low halogen requirements of <=1000ppm threshold. Antimony trioxide based flame retardants must also meet the <=1000ppm threshold requirement.

(3) MSL, Peak Temp. - The Moisture Sensitivity Level rating according to the JEDEC industry standard classifications, and peak solder temperature.

(4) There may be additional marking, which relates to the logo, the lot trace code information, or the environmental category on the device.

(5) Multiple Device Markings will be inside parentheses. Only one Device Marking contained in parentheses and separated by a "~" will appear on a device. If a line is indented then it is a continuation of the previous line and the two combined represent the entire Device Marking for that device.

(6) Lead/Ball Finish - Orderable Devices may have multiple material finish options. Finish options are separated by a vertical ruled line. Lead/Ball Finish values may wrap to two lines if the finish value exceeds the maximum column width.

**Important Information and Disclaimer:** The information provided on this page represents TI's knowledge and belief as of the date that it is provided. TI bases its knowledge and belief on information provided by third parties, and makes no representation or warranty as to the accuracy of such information. Efforts are underway to better integrate information from third parties. TI has taken and continues to take reasonable steps to provide representative and accurate information but may not have conducted destructive testing or chemical analysis on incoming materials and chemicals. TI and TI suppliers consider certain information to be proprietary, and thus CAS numbers and other limited information may not be available for release.

In no event shall TI's liability arising out of such information exceed the total purchase price of the TI part(s) at issue in this document sold by TI to Customer on an annual basis.

**TAPE AND REEL INFORMATION**

**QUADRANT ASSIGNMENTS FOR PIN 1 ORIENTATION IN TAPE**

\*All dimensions are nominal

Device	Package Type	Package Drawing	Pins	SPQ	Reel Diameter (mm)	Reel Width W1 (mm)	A0 (mm)	B0 (mm)	K0 (mm)	P1 (mm)	W (mm)	Pin1 Quadrant
DAC7724U/1K	SOIC	DW	28	1000	330.0	32.4	11.35	18.67	3.1	16.0	32.0	Q1
DAC7724UB/1K	SOIC	DW	28	1000	330.0	32.4	11.35	18.67	3.1	16.0	32.0	Q1
DAC7725UB/1K	SOIC	DW	28	1000	330.0	32.4	11.35	18.67	3.1	16.0	32.0	Q1

## TAPE AND REEL BOX DIMENSIONS



\*All dimensions are nominal

Device	Package Type	Package Drawing	Pins	SPQ	Length (mm)	Width (mm)	Height (mm)
DAC7724U/1K	SOIC	DW	28	1000	350.0	350.0	66.0
DAC7724UB/1K	SOIC	DW	28	1000	350.0	350.0	66.0
DAC7725UB/1K	SOIC	DW	28	1000	350.0	350.0	66.0

## IMPORTANT NOTICE AND DISCLAIMER

TI PROVIDES TECHNICAL AND RELIABILITY DATA (INCLUDING DATASHEETS), DESIGN RESOURCES (INCLUDING REFERENCE DESIGNS), APPLICATION OR OTHER DESIGN ADVICE, WEB TOOLS, SAFETY INFORMATION, AND OTHER RESOURCES "AS IS" AND WITH ALL FAULTS, AND DISCLAIMS ALL WARRANTIES, EXPRESS AND IMPLIED, INCLUDING WITHOUT LIMITATION ANY IMPLIED WARRANTIES OF MERCHANTABILITY, FITNESS FOR A PARTICULAR PURPOSE OR NON-INFRINGEMENT OF THIRD PARTY INTELLECTUAL PROPERTY RIGHTS.

These resources are intended for skilled developers designing with TI products. You are solely responsible for (1) selecting the appropriate TI products for your application, (2) designing, validating and testing your application, and (3) ensuring your application meets applicable standards, and any other safety, security, or other requirements. These resources are subject to change without notice. TI grants you permission to use these resources only for development of an application that uses the TI products described in the resource. Other reproduction and display of these resources is prohibited. No license is granted to any other TI intellectual property right or to any third party intellectual property right. TI disclaims responsibility for, and you will fully indemnify TI and its representatives against, any claims, damages, costs, losses, and liabilities arising out of your use of these resources.

TI's products are provided subject to TI's Terms of Sale ([www.ti.com/legal/termsofsale.html](http://www.ti.com/legal/termsofsale.html)) or other applicable terms available either on [ti.com](http://ti.com) or provided in conjunction with such TI products. TI's provision of these resources does not expand or otherwise alter TI's applicable warranties or warranty disclaimers for TI products.

Mailing Address: Texas Instruments, Post Office Box 655303, Dallas, Texas 75265  
Copyright © 2019, Texas Instruments Incorporated

## Looking for pricing, stock, or lifecycle information?

Click below to explore more details on WIN SOURCE:

 [View DAC7724NB/750G4 on WIN SOURCE](#)

 [Texas Instruments](#) Information

## Optimize Your Supply Chain with WIN SOURCE Solutions

-  Global Sourcing Solution
-  Obsolete Management
-  Cost Control Management
-  Shortage Management
-  Alternative Solution
-  Excess Inventory Management