



THE DATASHEET OF TS931AIDT



Output rail-to-rail micropower operational amplifiers

Datasheet – production data

Features

- Rail-to-rail output voltage swing
- Micropower consumption (20 μ A)
- Single supply operation (2.7 to 10 V)
- Low offset (2 mV max. for TS93xB)
- CMOS inputs
- Ultra low input bias current (1 pA)
- ESD protection (2 kV)
- Latch-up immunity (class A)
- Available in SO-8, SO-14, SOT23-5, and TSSOP-14 package
- Automotive grade

Applications

- Battery powered systems
- Portable communication systems
- Alarms, smoke detectors
- Instrumentation and sensing
- PH meters
- Digital scales
- Automotive

Description

The TS93x (single, dual and quad) series are operational amplifiers that can operate with voltages as low as 2.7 V and reach a 2.9 V_{pp} output swing with R_L = 100 k Ω when supplied at 3 V.

Offering a typical consumption of only 20 μ A, these devices are particularly well suited to battery powered applications.

The amplifiers space saving 5-pin SOT23-5 package with outer dimensions of 2.8 mm x 2.9 mm make them very easy to implement on a board design.

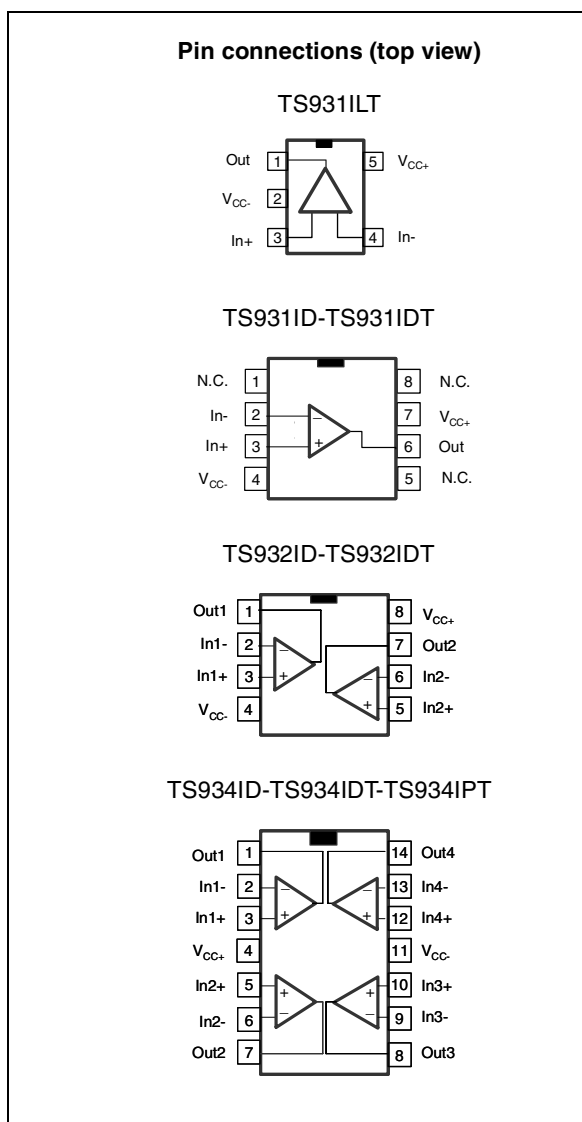

Table 1. Device summary

Reference	Part number
TS93x	TS931, TS932, TS934
TS93xA	TS931A, TS932A, TS934A
TS93xB	TS931B, TS932B, TS934B

1 Absolute maximum ratings and operating conditions

Table 2. Absolute maximum ratings

Symbol	Parameter	Value	Unit
V_{CC}	Supply voltage ⁽¹⁾	12	V
V_{id}	Differential input voltage ⁽²⁾	$\pm V_{CC}$	V
V_{in}	Input voltage range ⁽³⁾	$V_{CC-} -0.3$ to $V_{CC+} +0.3$	V
I_{in}	Input current range ⁽⁴⁾	10	mA
T_{std}	Storage temperature range	-65 to +150	°C
T_j	Maximum junction temperature	150	°C
R_{thja}	Thermal resistance junction-to-ambient ⁽⁵⁾		
	– SOT23-5	250	°C/W
	– SO8	125	
	– SO14	103	
– TSSOP14	100		
ESD	HBM: human body model ⁽⁶⁾	2	kV
	MM: machine model ⁽⁷⁾	200	V
	CDM: charged device model ⁽⁸⁾	2	kV
	Latch-up immunity	200	mA
	Soldering temperature (10 sec.), leaded version	250	°C

1. All voltages values, except differential voltage are with respect to network terminal.
2. Differential voltages are non-inverting input terminal with respect to the inverting input terminal.
3. The magnitude of input and output voltages must never exceed $V_{CC+} +0.3$ V.
4. Input current must be limited by a resistor in series with the inputs.
5. Short-circuits can cause excessive heating and destructive dissipation.
6. Human body model: 100 pF discharged through a 1.5 kΩ resistor into pin of device.
7. Machine model ESD: a 200 pF capacitor is charged to the specified voltage, then discharged directly into the IC with no external series resistor (internal resistor < 5 Ω), into pin-to-pin of device.
8. Charged device model: all pins and the package are charged together to the specified voltage and then discharged directly to ground through only one pin. This is done for all pins.

Table 3. Operating conditions

Symbol	Parameter	Value	Unit
V_{CC}	Supply voltage	2.7 to 10	V
V_{icm}	Common mode input voltage range	$V_{CC-} -0.2$ to $V_{CC+} -1.5$	V
T_{oper}	Operating free air temperature range	-40 to +105	°C

2 Electrical characteristics

[Table 4](#) and [Table 5](#) give the electrical characteristics at each V_{CC} value.

Table 4. Electrical characteristics at $V_{CC+} = +3\text{ V}$, $V_{CC-} = 0\text{ V}$, $T_{\text{amb}} = 25\text{ °C}$ (unless otherwise specified)

Symbol	Parameter	Min.	Typ.	Max.	Unit
V_{io}	Input offset voltage TS931/2/4 TS931/2/4A TS931/2/4B			10 5 2	mV
	$T_{\text{min}} < T_{\text{op}} < T_{\text{max}}$ TS931/2/4 TS931/2/4A TS931/2/4B			15 10 6	
ΔV_{io}	Input offset voltage drift		3		$\mu\text{V}/\text{°C}$
I_{io}	Input offset current ⁽¹⁾ $T_{\text{min}} < T_{\text{op}} < T_{\text{max}}$		1	100 200	pA
I_{ib}	Input bias current ⁽¹⁾ $T_{\text{min}} < T_{\text{op}} < T_{\text{max}}$		1	150 300	pA
CMR	Common mode rejection ratio, $0 \leq V_{\text{icm}} \leq V_{\text{CC+}} - 1.7$ $T_{\text{min}} < T_{\text{op}} < T_{\text{max}}$	55	85		dB
		55	85		
SVR	Supply voltage rejection ratio ⁽²⁾ $T_{\text{min}} < T_{\text{op}} < T_{\text{max}}$	55	85		dB
		55	85		
A_{vd}	Large signal voltage gain $V_{\text{O}} = 2\text{ V}_{\text{pp}}$, $R_{\text{L}} = 1\text{ M}\Omega$ $R_{\text{L}} = 100\text{ k}\Omega$		120 106		dB
V_{OH}	High level output voltage, $V_{\text{ID}} = 100\text{ mV}$, $R_{\text{L}} = 100\text{ k}\Omega$ $T_{\text{min}} < T_{\text{op}} < T_{\text{max}}$	2.95 2.95	2.99		V
V_{OL}	Low level output voltage, $V_{\text{ID}} = -100\text{ mV}$, $R_{\text{L}} = 100\text{ k}\Omega$ $T_{\text{min}} < T_{\text{op}} < T_{\text{max}}$		10	50 50	mV
I_{o}	Output source current $V_{\text{ID}} = 100\text{ mV}$, $V_{\text{O}} = V_{\text{CC-}}$		1.5		mA
	Output sink current $V_{\text{ID}} = -100\text{ mV}$, $V_{\text{O}} = V_{\text{CC+}}$		1.5		
I_{CC}	Supply current (per amplifier), $A_{\text{VCL}} = 1$, no load $T_{\text{min}} < T_{\text{op}} < T_{\text{max}}$		20	31 33	μA
GBP	Gain bandwidth product $R_{\text{L}} = 100\text{ k}\Omega$, $C_{\text{L}} = 50\text{ pF}$		100		kHz
SR	Slew rate $R_{\text{L}} = 100\text{ k}\Omega$, $C_{\text{L}} = 50\text{ pF}$		50		V/ms

Table 4. Electrical characteristics at $V_{CC+} = +3\text{ V}$, $V_{CC-} = 0\text{ V}$, $T_{amb} = 25\text{ }^\circ\text{C}$ (unless otherwise specified) (continued)

Symbol	Parameter	Min.	Typ.	Max.	Unit
ϕ_m	Phase margin $C_L = 50\text{ pF}$		65		Degrees
en	Input voltage noise		75		nV/ $\sqrt{\text{Hz}}$

1. Maximum values including unavoidable inaccuracies of the industrial test.
2. V_{CC} has a 0.2 V variation.

Table 5. Electrical characteristics at $V_{CC+} = +5\text{ V}$, $V_{CC-} = 0\text{ V}$, $T_{amb} = 25\text{ }^\circ\text{C}$ (unless otherwise specified)

Symbol	Parameter	Min.	Typ.	Max.	Unit
V_{io}	Input offset voltage TS931/2/4 TS931/2/4A TS931/2/4B			10 5 2	mV
	$T_{min} < T_{op} < T_{max}$ TS931/2/4 TS931/2/4A TS931/2/4B			15 10 6	
ΔV_{io}	Input offset voltage drift		3		$\mu\text{V}/^\circ\text{C}$
I_{io}	Input offset current ⁽¹⁾ $T_{min} < T_{op} < T_{max}$		1	100 200	pA
I_{ib}	Input bias current ⁽¹⁾ $T_{min} < T_{op} < T_{max}$		1	150 300	pA
CMR	Common mode rejection ratio, $0 \leq V_{icm} \leq V_{CC+} - 1.7$ $T_{min} < T_{op} < T_{max}$	55 55	85 85		dB
SVR	Supply voltage rejection ratio ⁽²⁾ $T_{min} < T_{op} < T_{max}$	55 55	85 85		dB
A_{vd}	Large signal voltage gain $V_O = 4\text{ Vpp}$, $R_L = 1\text{ M}\Omega$ $R_L = 100\text{ k}\Omega$		120 112		dB
V_{OH}	High level output voltage, $V_{ID} = 100\text{ mV}$, $R_L = 100\text{ k}\Omega$ $T_{min} < T_{op} < T_{max}$	4.95 4.95	4.99		V
V_{OL}	Low level output voltage, $V_{ID} = -100\text{ mV}$, $R_L = 100\text{ k}\Omega$ $T_{min} < T_{op} < T_{max}$		10	50 50	mV
I_o	Output source current $V_{ID} = 100\text{ mV}$, $V_O = V_{DD}$		5		mA
	Output sink current $V_{ID} = -100\text{ mV}$, $V_O = V_{CC}$		5		
I_{CC}	Supply current (per amplifier), $A_{VCL} = 1$, no load $T_{min} < T_{op} < T_{max}$		20	33 35	μA

**Table 5. Electrical characteristics at $V_{CC+} = +5\text{ V}$, $V_{CC-} = 0\text{ V}$, $T_{amb} = 25\text{ °C}$
(unless otherwise specified) (continued)**

Symbol	Parameter	Min.	Typ.	Max.	Unit
GBP	Gain bandwidth product $R_L = 100\text{ K}\Omega$, $C_L = 50\text{ pF}$		100		kHz
SR	Slew rate $R_L = 100\text{ K}\Omega$, $C_L = 50\text{ pF}$		50		V/ms
ϕ_m	Phase margin $C_L = 50\text{ pF}$		65		Degrees
en	Input voltage noise		76		nV/ $\sqrt{\text{Hz}}$

1. Maximum values including unavoidable inaccuracies of the industrial test.
2. V_{CC} has a 0.2 V variation.

Figure 1. Input offset voltage vs. temperature

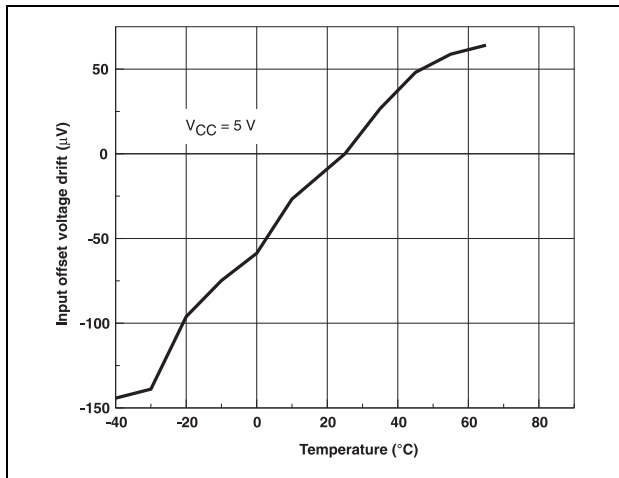

Figure 2. Supply current vs. supply voltage, in open loop configuration

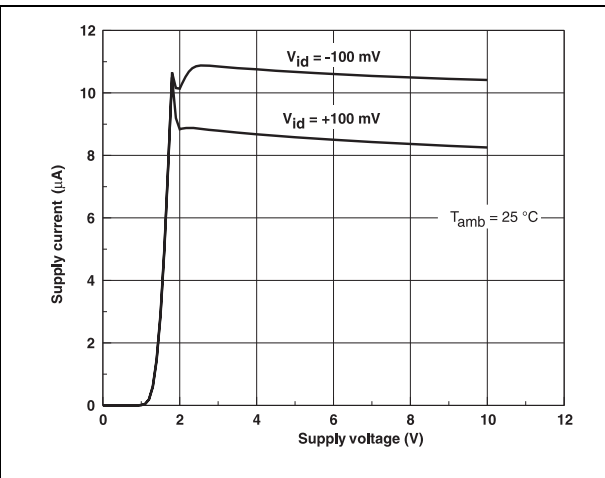

Figure 3. Supply current vs. supply voltage in follower configuration, $V_{icm} = V_{CC}/2$

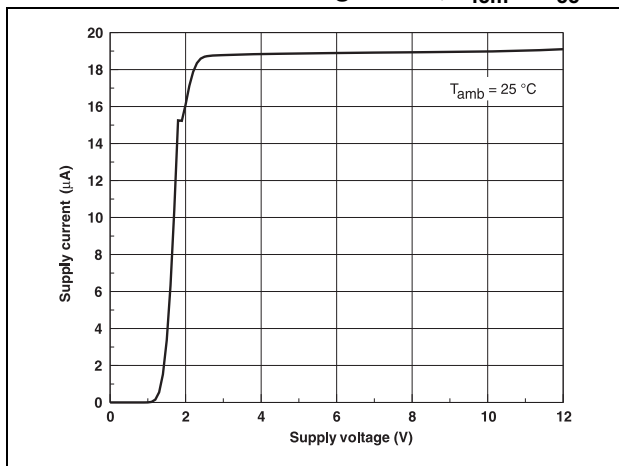

Figure 4. Supply current vs. temperature

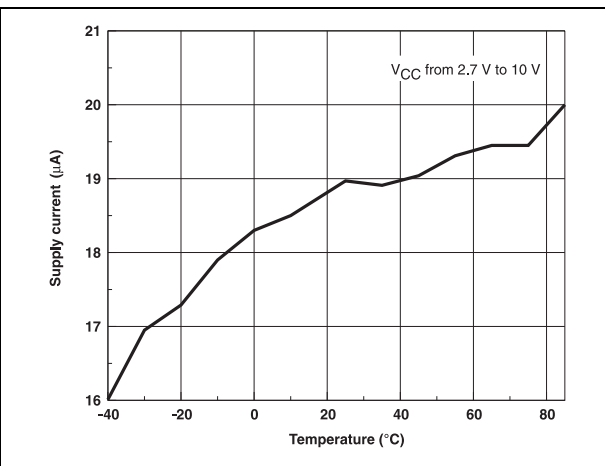

Figure 5. Output short-circuit current vs. temperature

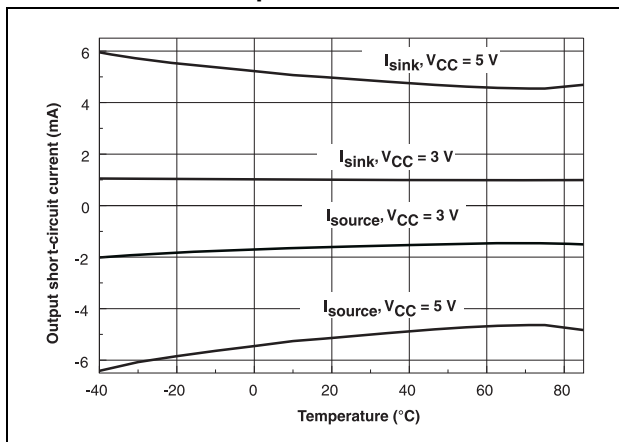

Figure 6. Output short-circuit current vs. supply voltage

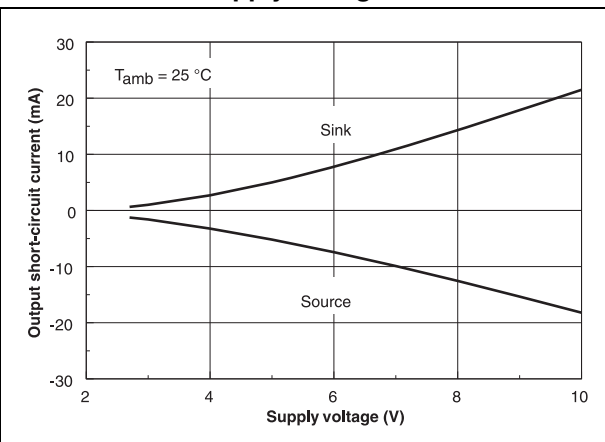

Figure 7. Output short-circuit current vs. output voltage at $V_{CC+} = 2.7\text{ V}$

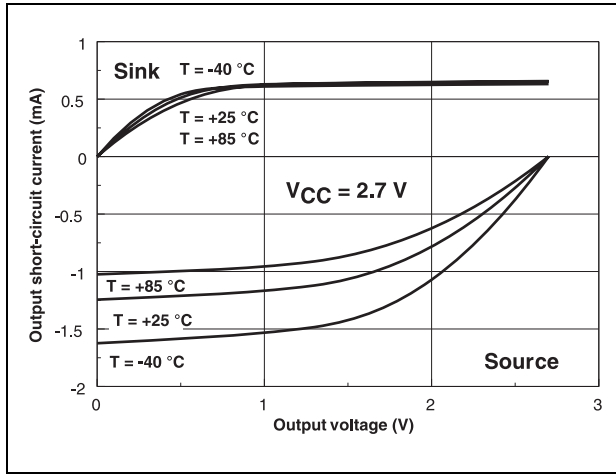

Figure 8. Output short-circuit current vs. output voltage at $V_{CC+} = 3\text{ V}$

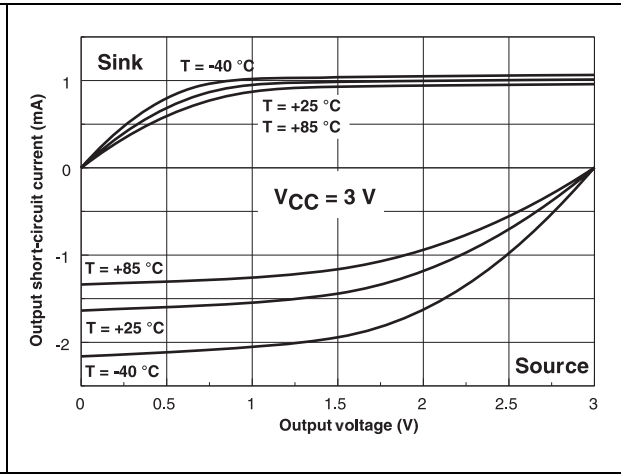

Figure 9. Output short-circuit current vs. output voltage at $V_{CC+} = 5\text{ V}$

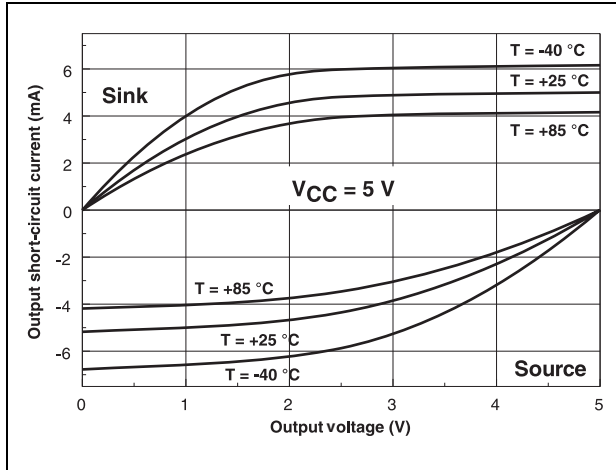

Figure 10. Output short-circuit current vs. output voltage at $V_{CC+} = 10\text{ V}$

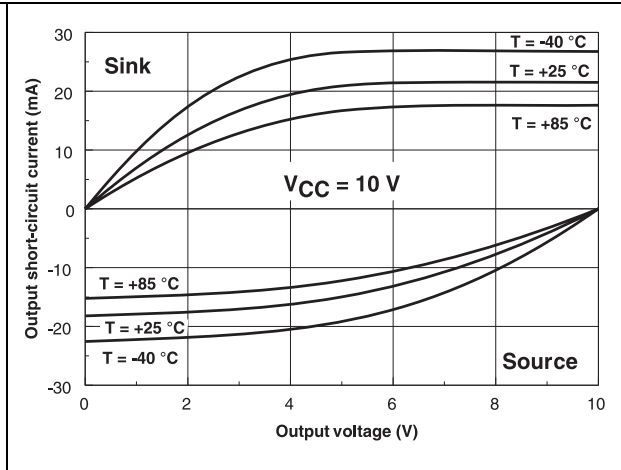

Figure 11. High level output voltage drop vs. supply voltage

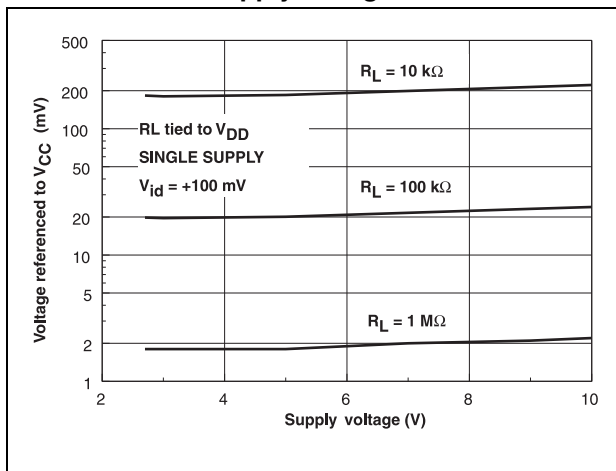

Figure 12. Low level output voltage drop vs. supply voltage

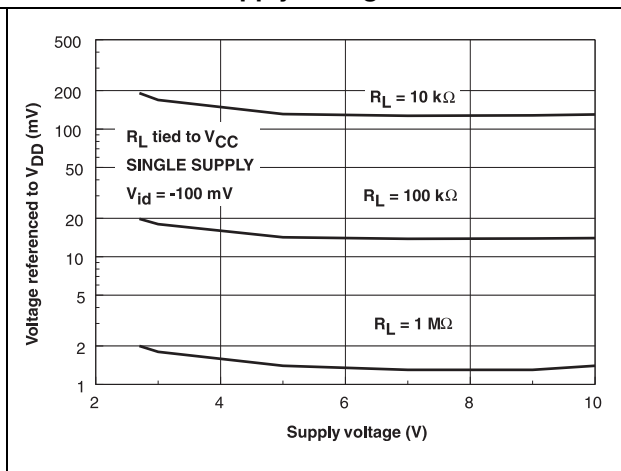

Figure 13. Voltage gain and phase vs. frequency for $C_L = 50$ pF

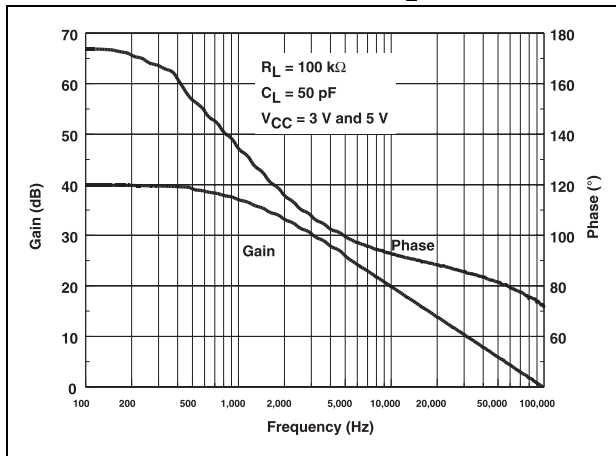

Figure 14. Voltage gain and phase vs. frequency for $C_L = 100$ pF

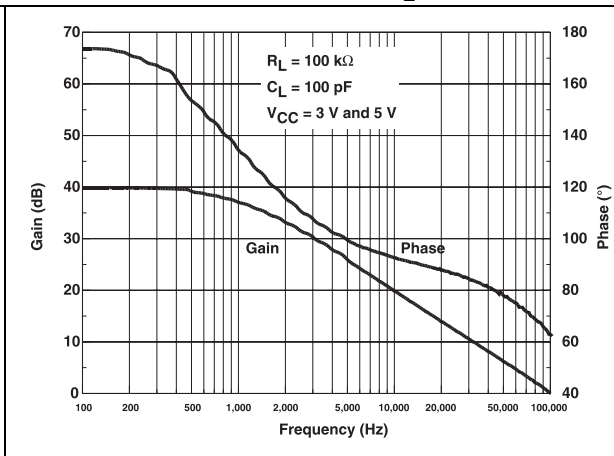

Figure 15. Distortion vs. frequency

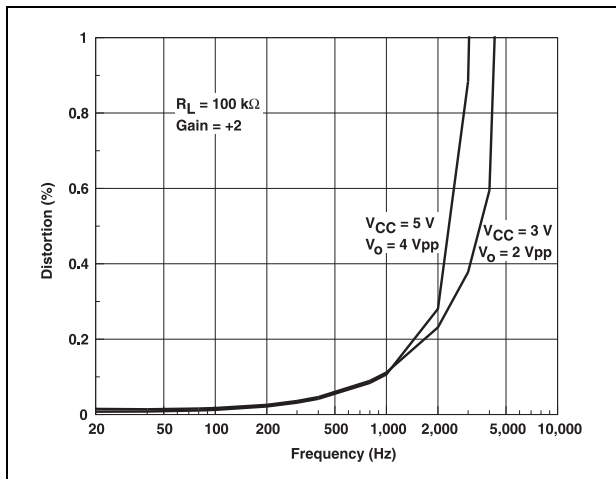

Figure 16. Equivalent input noise voltage vs. frequency

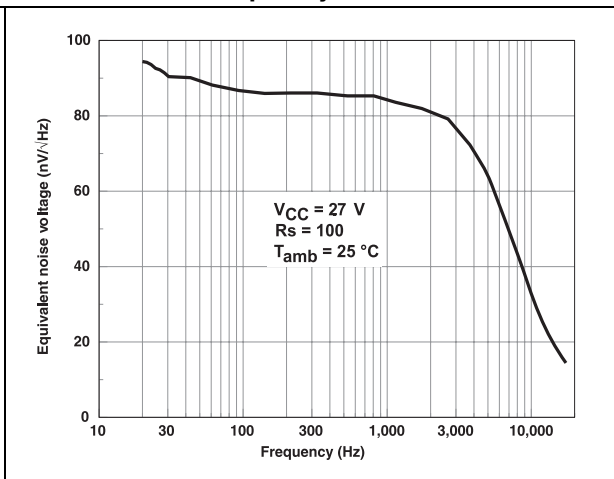

Figure 17. Distortion vs. output voltage

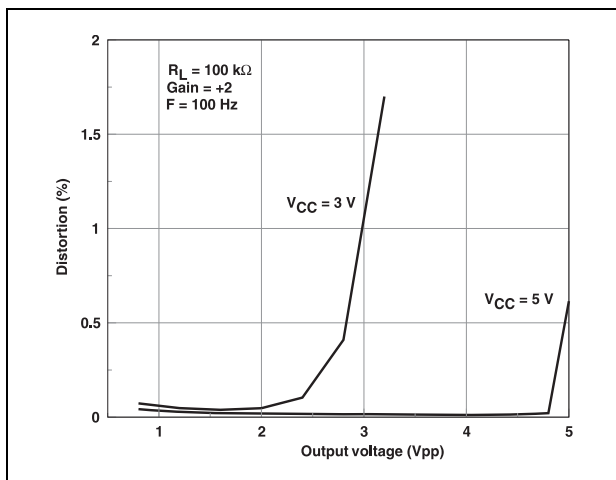

Figure 18. Supply voltage rejection vs. frequency

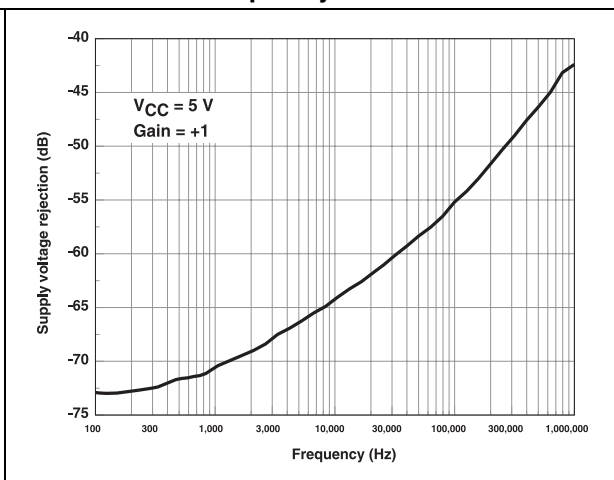

Figure 19. Slew rate vs. time for small input voltage signal

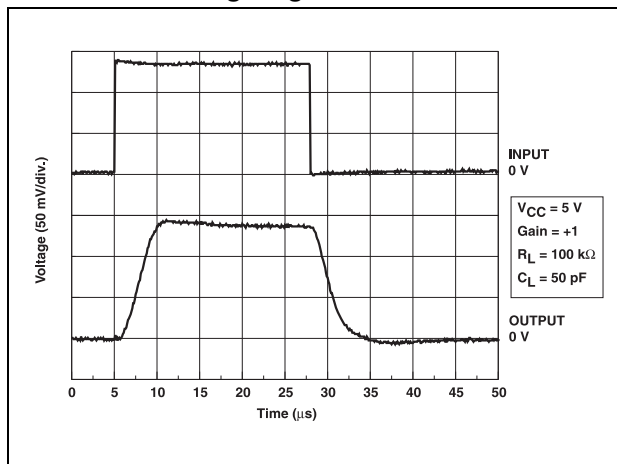
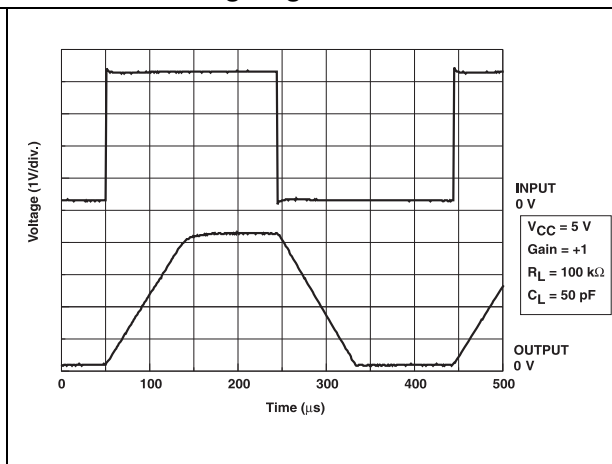

Figure 20. Slew rate vs. time for large input voltage signal



3 Package information

In order to meet environmental requirements, ST offers these devices in different grades of ECOPACK® packages, depending on their level of environmental compliance. ECOPACK specifications, grade definitions and product status are available at: www.st.com. ECOPACK is an ST trademark.

3.1 SO-8 package information

Figure 21. SO-8 package outline

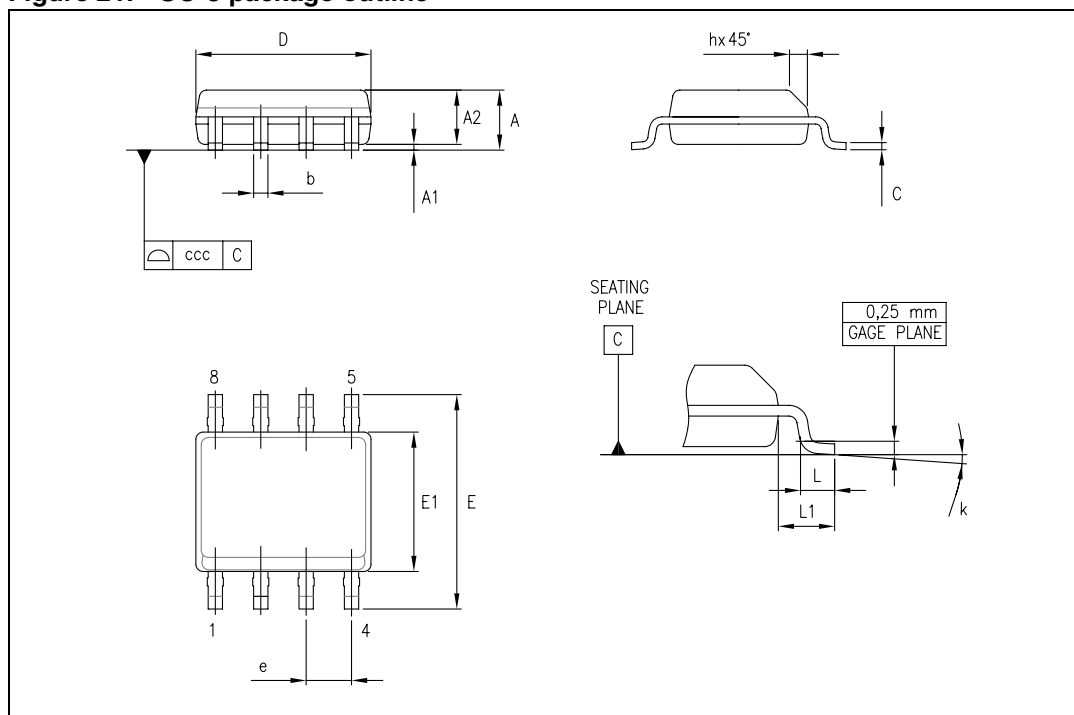

Table 6. SO-8 package mechanical data

Symbol	Dimensions					
	Millimeters			Inches		
	Min.	Typ.	Max.	Min.	Typ.	Max.
A			1.75			0.069
A1	0.10		0.25	0.004		0.010
A2	1.25			0.049		
b	0.28		0.48	0.011		0.019
c	0.17		0.23	0.007		0.010
D	4.80	4.90	5.00	0.189	0.193	0.197
E	5.80	6.00	6.20	0.228	0.236	0.244
E1	3.80	3.90	4.00	0.150	0.154	0.157
e		1.27			0.050	
h	0.25		0.50	0.010		0.020
L	0.40		1.27	0.016		0.050
L1		1.04			0.040	
k	1°		8°	1°		8°
ccc			0.10			0.004

3.2 SO-14 package information

Figure 22. SO-14 package outline

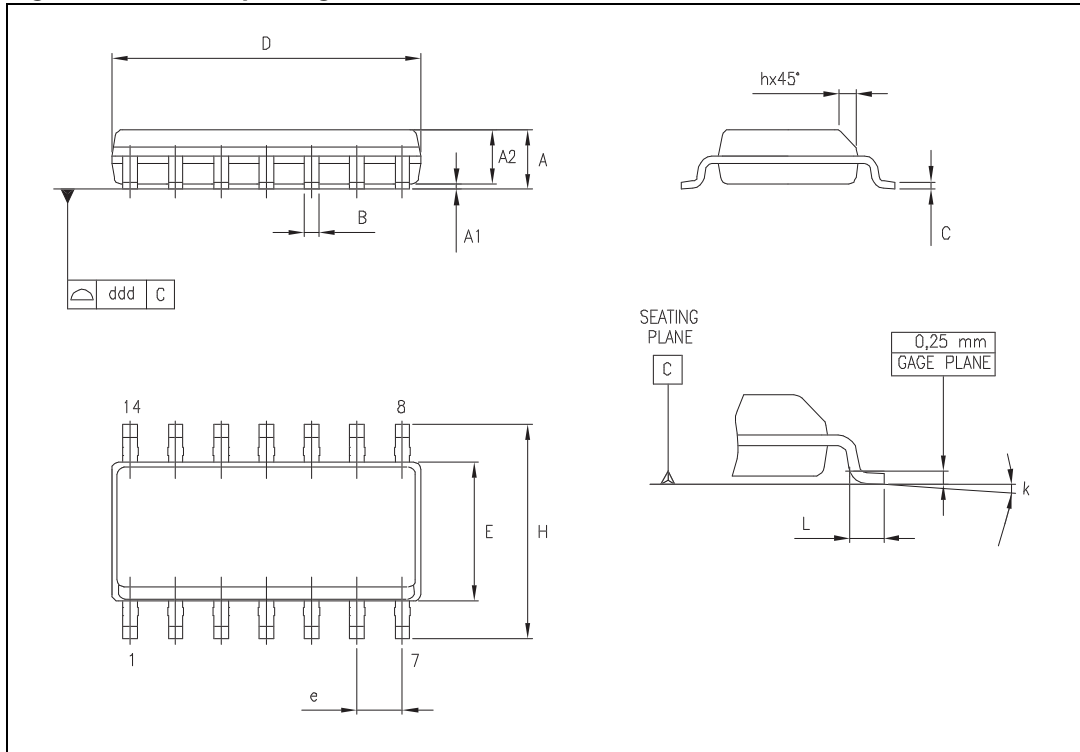

Table 7. SO-14 package mechanical data

Dimensions						
Symbol	Millimeters			Inches		
	Min.	Typ.	Max.	Min.	Typ.	Max.
A	1.35		1.75	0.05		0.068
A1	0.10		0.25	0.004		0.009
A2	1.10		1.65	0.04		0.06
B	0.33		0.51	0.01		0.02
C	0.19		0.25	0.007		0.009
D	8.55		8.75	0.33		0.34
E	3.80		4.0	0.15		0.15
e		1.27			0.05	
H	5.80		6.20	0.22		0.24
h	0.25		0.50	0.009		0.02
L	0.40		1.27	0.015		0.05
k	8° (max.)					
ddd			0.10			0.004

3.3 TSSOP14 package information

Figure 23. TSSOP14 package outline

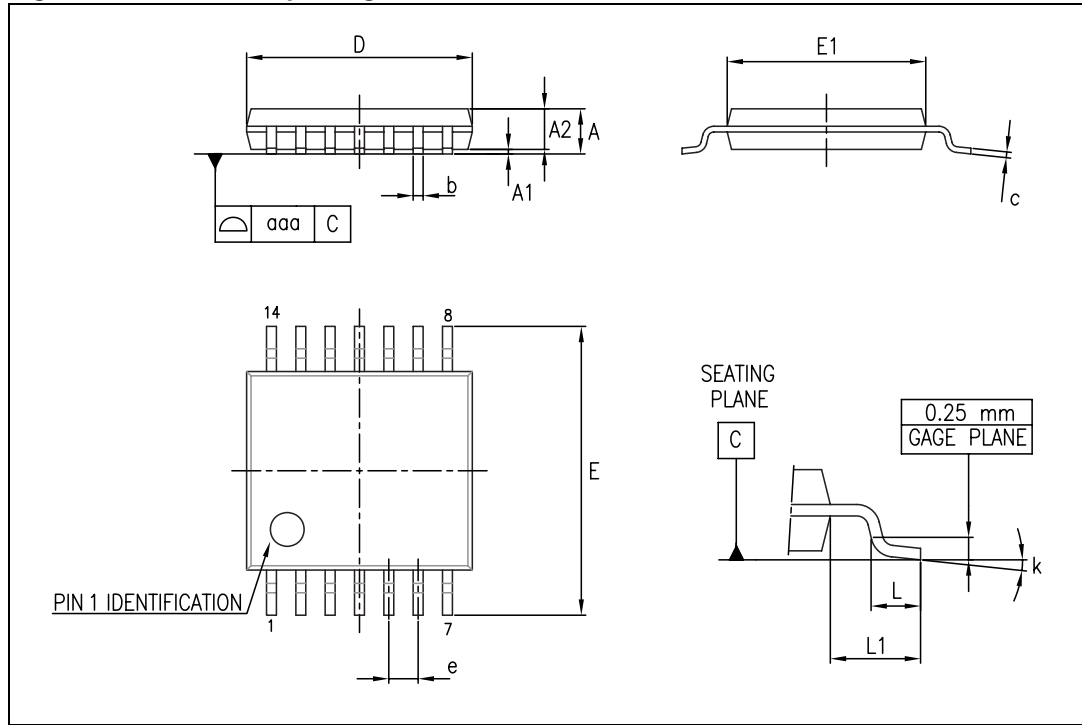

Table 8. TSSOP14 package mechanical data

Symbol	Dimensions					
	Millimeters			Inches		
	Min.	Typ.	Max.	Min.	Typ.	Max.
A			1.20			0.047
A1	0.05		0.15	0.002	0.004	0.006
A2	0.80	1.00	1.05	0.031	0.039	0.041
b	0.19		0.30	0.007		0.012
c	0.09		0.20	0.004		0.0089
D	4.90	5.00	5.10	0.193	0.197	0.201
E	6.20	6.40	6.60	0.244	0.252	0.260
E1	4.30	4.40	4.50	0.169	0.173	0.176
e		0.65			0.0256	
L	0.45	0.60	0.75	0.018	0.024	0.030
L1		1.00			0.039	
k	0°		8°	0°		8°
aaa			0.10			0.004

3.4 SOT23-5 package information

Figure 24. SOT23-5 package outline

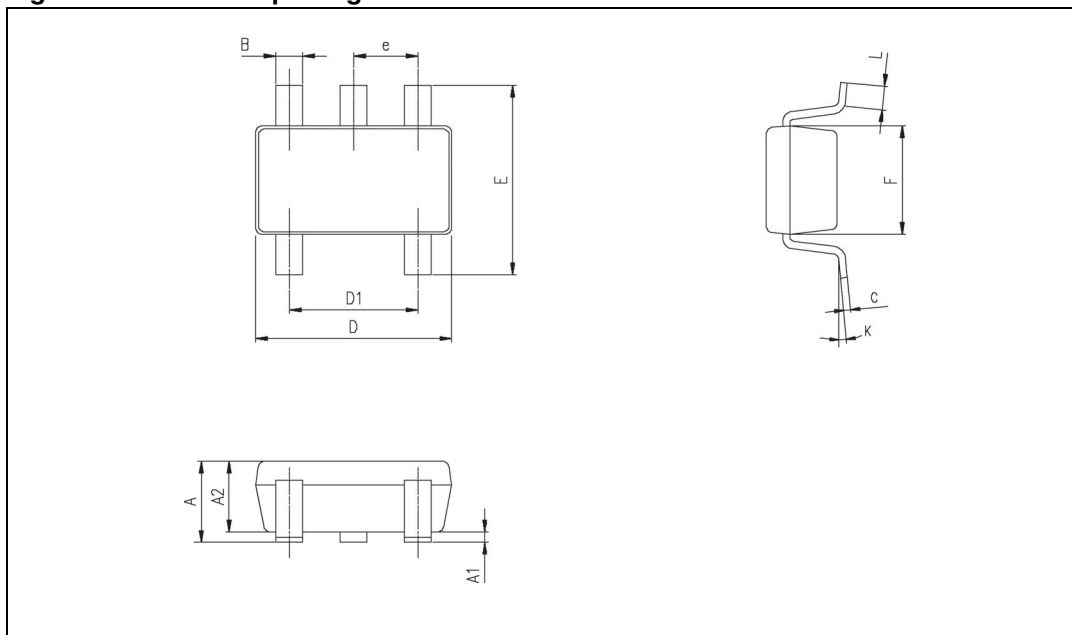

Table 9. SOT23-5 package mechanical data

Symbol	Dimensions					
	Millimeters			Inches		
	Min.	Typ.	Max.	Min.	Typ.	Max.
A	0.90	1.20	1.45	0.035	0.047	0.057
A1			0.15			0.006
A2	0.90	1.05	1.30	0.035	0.041	0.051
B	0.35	0.40	0.50	0.013	0.015	0.019
C	0.09	0.15	0.20	0.003	0.006	0.008
D	2.80	2.90	3.00	0.110	0.114	0.118
D1		1.90			0.075	
e		0.95			0.037	
E	2.60	2.80	3.00	0.102	0.110	0.118
F	1.50	1.60	1.75	0.059	0.063	0.069
L	0.10	0.35	0.60	0.004	0.013	0.023
K	0 degrees		10 degrees			

4 Ordering information

Table 10. Order codes

Order code	Temperature range	Package	Packaging	Marking
TS931ID TS931IDT TS931AID TS931AIDT TS931BID TS931BIDT	-40 °C, +105 °C	SO-8	Tube Tape and reel Tube Tape and reel Tube Tape and reel	931I 931I 931AI 931AI 931BI 931BI
TS931ILT TS931AILT TS931BILT		SOT23-5L	Tape and reel	K205 K206 K207
TS932ID TS932IDT TS932AID TS932AIDT TS932BID TS932BIDT		SO-8	Tube Tape and reel Tube Tape and reel Tube Tape and reel	932I 932I 932AI 932AI 932BI 932BI
TS934ID TS934IDT TS934AID TS934AIDT TS934BIDT TS934BIDT		SO-14	Tube Tape and reel Tube Tape and reel Tube Tape and reel	934I 934I 934AI 934AI 934BI 934BI
TS934IPT TS934AIPT TS934BIPT		TSSOP-14 (thin shrink outline package)	Tape and reel	934I 934AI 934BI
TS934IYDT ⁽¹⁾ TS934AIYDT ⁽¹⁾		SO-14 (automotive grade)	Tape and reel	934IY 934AIY

1. Qualified and characterized according to AEC Q100 and Q003 or equivalent, advanced screening according to AEC Q001 and Q 002 or equivalent.

5 Revision history

Table 11. Document revision history

Date	Revision	Changes
01-Nov-2001	1	Initial release.
01-Dec-2004	2	Modified AMR values in Table 2 (explanation of Vid and Vi limits).
04-May-2009	3	Document reformatted. Removed DIP package information and order codes from Chapter 3 . Modified temperature range: extended to -40 to +105° C in Table 10: Order codes . Added automotive grade products in Table 10 .
07-Sep-2009	4	Added root part numbers (TS93xA, TS93xB) and Table 1: Device summary on cover page. Added parameters for full temperature range in Table 4 and in Table 5 .
07-Nov-2012	5	Updated Features (added SO-8, SO-14, and TSSOP-14 package). Updated Table 2 (removed TSSOP8 package). Removed TS934IYD and TS934AIYD order codes from Table 10 , qualified status of TS934IYDT and TS934AIYDT order codes in Table 10 . Minor corrections throughout document.

Please Read Carefully:

Information in this document is provided solely in connection with ST products. STMicroelectronics NV and its subsidiaries ("ST") reserve the right to make changes, corrections, modifications or improvements, to this document, and the products and services described herein at any time, without notice.

All ST products are sold pursuant to ST's terms and conditions of sale.

Purchasers are solely responsible for the choice, selection and use of the ST products and services described herein, and ST assumes no liability whatsoever relating to the choice, selection or use of the ST products and services described herein.

No license, express or implied, by estoppel or otherwise, to any intellectual property rights is granted under this document. If any part of this document refers to any third party products or services it shall not be deemed a license grant by ST for the use of such third party products or services, or any intellectual property contained therein or considered as a warranty covering the use in any manner whatsoever of such third party products or services or any intellectual property contained therein.

UNLESS OTHERWISE SET FORTH IN ST'S TERMS AND CONDITIONS OF SALE ST DISCLAIMS ANY EXPRESS OR IMPLIED WARRANTY WITH RESPECT TO THE USE AND/OR SALE OF ST PRODUCTS INCLUDING WITHOUT LIMITATION IMPLIED WARRANTIES OF MERCHANTABILITY, FITNESS FOR A PARTICULAR PURPOSE (AND THEIR EQUIVALENTS UNDER THE LAWS OF ANY JURISDICTION), OR INFRINGEMENT OF ANY PATENT, COPYRIGHT OR OTHER INTELLECTUAL PROPERTY RIGHT.

UNLESS EXPRESSLY APPROVED IN WRITING BY TWO AUTHORIZED ST REPRESENTATIVES, ST PRODUCTS ARE NOT RECOMMENDED, AUTHORIZED OR WARRANTED FOR USE IN MILITARY, AIR CRAFT, SPACE, LIFE SAVING, OR LIFE SUSTAINING APPLICATIONS, NOR IN PRODUCTS OR SYSTEMS WHERE FAILURE OR MALFUNCTION MAY RESULT IN PERSONAL INJURY, DEATH, OR SEVERE PROPERTY OR ENVIRONMENTAL DAMAGE. ST PRODUCTS WHICH ARE NOT SPECIFIED AS "AUTOMOTIVE GRADE" MAY ONLY BE USED IN AUTOMOTIVE APPLICATIONS AT USER'S OWN RISK.

Resale of ST products with provisions different from the statements and/or technical features set forth in this document shall immediately void any warranty granted by ST for the ST product or service described herein and shall not create or extend in any manner whatsoever, any liability of ST.

ST and the ST logo are trademarks or registered trademarks of ST in various countries.

Information in this document supersedes and replaces all information previously supplied.

The ST logo is a registered trademark of STMicroelectronics. All other names are the property of their respective owners.

© 2012 STMicroelectronics - All rights reserved

STMicroelectronics group of companies



Australia - Belgium - Brazil - Canada - China - Czech Republic - Finland - France - Germany - Hong Kong - India - Israel - Italy - Japan - Malaysia - Malta - Morocco - Philippines - Singapore - Spain - Sweden - Switzerland - United Kingdom - United States of America

www.st.com



Looking for pricing, stock, or lifecycle information?

Click below to explore more details on WIN SOURCE:

-  [View TS931AIDT on WIN SOURCE](#)
-  [STMicroelectronics Information](#)

Optimize Your Supply Chain with WIN SOURCE Solutions

-  Global Sourcing Solution
-  Obsolete Management
-  Cost Control Management
-  Shortage Management
-  Alternative Solution
-  Excess Inventory Management