



THE DATASHEET OF TS1852IPT



1.8 V input/output, rail-to-rail, low power operational amplifiers

Features

- Operating range from $V_{CC} = 1.8$ to 6 V
- Rail-to-rail input and output
- Extended V_{icm} ($V_{CC-} - 0.2$ V to $V_{CC+} + 0.2$ V)
- Low supply current (120 μ A)
- Good accuracy (1 mV max for A version)
- Gain bandwidth product (530 kHz)
- High unity gain stability (able to drive 500 pF)
- ESD tolerance (2 kV)
- Latch-up immunity
- Available in SOT23-5 micropackage

Applications

- Two-cell battery-powered systems
- Battery-powered electronic equipment
- Cordless phones
- Cellular phones
- Laptops
- PDAs

Description

The TS185x (single, dual and quad) can operate with voltages as low as 1.8 V. They feature both input and output rail-to-rail (1.71 at $V_{CC} = 1.8$ V, $R_L = 2$ k Ω), 120 μ A current consumption and 530 kHz gain bandwidth product.

With this low consumption and a sufficient GBP for many applications, these operational amplifiers are well-suited to all kinds of battery supplied and portable applications.

The TS1851 is housed in the space-saving 5-pin SOT23-5 package, which simplifies board design (outside dimensions are 2.8 mm x 2.9 mm).

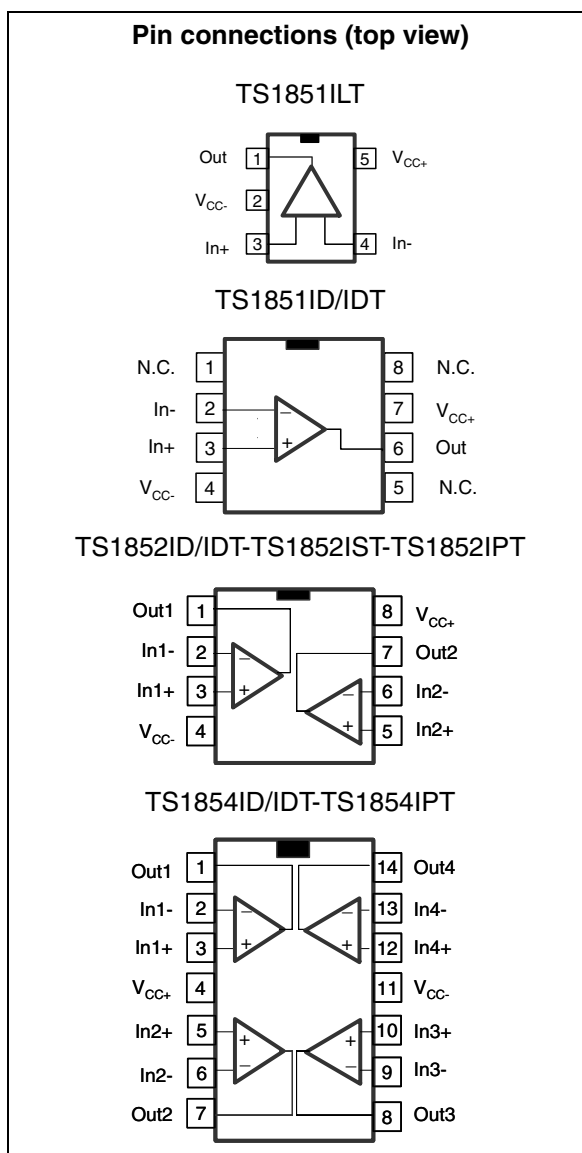

Table 1. Device summary

Reference	Single version	Dual version	Quad version
TS185x	TS1851	TS1852	TS1854
TS185xA	TS1851A	TS1852A	TS1854A

Contents

1	Absolute maximum ratings and operating conditions	3
2	Electrical characteristics	5
3	Package information	15
3.1	SO-8 package information	16
3.2	TSSOP8 package information	17
3.3	MiniSO-8 package information	18
3.4	SO-14 package information	19
3.5	TSSOP14 package information	20
3.6	SOT23-5 package information	21
4	Ordering information	22
5	Revision history	23

1 Absolute maximum ratings and operating conditions

Table 2. Absolute maximum ratings

Symbol	Parameter	Value	Unit
V_{CC}	Supply voltage ⁽¹⁾	7	V
V_{id}	Differential input voltage ⁽²⁾	± 1	V
V_i	Input voltage	$V_{CC-} - 0.3$ to $V_{CC+} + 0.3$	V
T_{oper}	Operating free-air temperature range	-40 to + 125	°C
T_{stg}	Storage temperature	-65 to +150	°C
T_j	Maximum junction temperature	150	°C
R_{thja}	Thermal resistance junction to ambient ⁽³⁾		°C/W
	SOT23-5	250	
	miniSO-8	190	
	SO-8	125	
	SO-14	103	
	TSSOP8 TSSOP14	120 100	
R_{thjc}	Thermal resistance junction to case		°C/W
	SOT23-5	81	
	miniSO-8	39	
	SO-8	40	
	SO-14	31	
	TSSOP8 TSSOP14	37 32	
ESD	HBM: human body model ⁽⁴⁾	2	kV
	MM: machine model ⁽⁵⁾	200	V
	CDM: charged device model ⁽⁶⁾	1.5	kV
	Lead temperature (soldering, 10sec)	250	°C
	Output short-circuit duration	See note ⁽⁷⁾	

- All voltage values, except differential voltages, are with respect to network terminal.
- Differential voltages are the non-inverting input terminal with respect to the inverting input terminal. If $V_{id} > \pm 1$ V, the maximum input current must not exceed ± 1 mA. When $V_{id} > \pm 1$ V, add an input series resistor to limit the input current.
- Short-circuits can cause excessive heating. Destructive dissipation can result from simultaneous short-circuits on all amplifiers.
- Human body model: a 100 pF capacitor is charged to the specified voltage, then discharged through a 1.5 k Ω resistor between two pins of the device. This is done for all couples of connected pin combinations while the other pins are floating.
- Machine model: a 200 pF capacitor is charged to the specified voltage, then discharged directly between two pins of the device with no external series resistor (internal resistor < 5 Ω). This is done for all couples of connected pin combinations while the other pins are floating.
- Charged device model: all pins and package are charged together to the specified voltage and then discharged directly to ground through only one pin. This is done for all pins.
- Short-circuits from the output to V_{CC} can cause excessive heating. The maximum output current is approximately 48 mA, independent of the magnitude of V_{CC} . Destructive dissipation can result from simultaneous short-circuits on all amplifiers.

Table 3. Operating conditions

Symbol	Parameter	Value	Unit
V_{CC}	Supply voltage	1.8 to 6	V
V_{icm}	Common-mode input voltage range $T_{op} = 25^{\circ}\text{C}$, $1.8 \leq V_{CC} \leq 6\text{ V}$ $T_{min} < T_{op} < T_{max}$, $1.8 \leq V_{CC} \leq 5.5\text{ V}$	$V_{CC-} - 0.2$ to $V_{CC+} + 0.2$ V_{CC-} to V_{CC+}	V
T_{oper}	Operating free-air temperature range	-40 to + 125	$^{\circ}\text{C}$

2 Electrical characteristics

Table 4. Electrical characteristics measured at $V_{CC+} = +1.8\text{ V}$, $V_{CC-} = 0\text{ V}$, with C_L and R_L connected to $V_{CC}/2$, $T_{amb} = 25^\circ\text{C}$ (unless otherwise specified) ⁽¹⁾

Symbol	Parameter	Conditions	Min.	Typ.	Max.	Unit
V_{io}	Input offset voltage	TS1851/2/4 $T_{min} \leq T_{amb} \leq T_{max}$ TS1851A/2A/4A $T_{min} \leq T_{amb} \leq T_{max}$		0.1	3 6 1 1.5	mV
ΔV_{io}	Input offset voltage drift			2		$\mu\text{V}/^\circ\text{C}$
I_{io}	Input offset current	$V_{icm} = V_{out} = V_{CC}/2$ ⁽²⁾ $T_{min} \leq T_{amb} \leq T_{max}$		1	9 25	nA
I_{ib}	Input bias current	$V_{icm} = V_{out} = V_{CC}/2$ ⁽²⁾ $T_{min} \leq T_{amb} \leq T_{max}$		10	50 80	nA
CMR	Common mode rejection ratio $20 \log (\Delta V_{ic}/\Delta V_{io})$	$0 \leq V_{icm} \leq V_{CC}$ $T_{min} \leq T_{amb} \leq T_{max}$	55 52	85		dB
A_{vd}	Large signal voltage gain	$V_{out} = 0.5$ to 1.3 V $R_L = 10\text{ k}\Omega$ $R_L = 2\text{ k}\Omega$	80 70	100 100		dB
V_{OH}	High level output voltage	$V_{id} = 100\text{ mV}$ $R_L = 10\text{ k}\Omega$ $R_L = 2\text{ k}\Omega$ $T_{min} \leq T_{amb} \leq T_{max}$, $R_L = 10\text{ k}\Omega$ $T_{min} \leq T_{amb} \leq T_{max}$, $R_L = 2\text{ k}\Omega$	1.7 1.65 1.7 1.65	1.77 1.7		V
V_{OL}	Low level output voltage	$V_{id} = -100\text{ mV}$ $R_L = 10\text{ k}\Omega$ $R_L = 2\text{ k}\Omega$ $T_{min} \leq T_{amb} \leq T_{max}$, $R_L = 10\text{ k}\Omega$ $T_{min} \leq T_{amb} \leq T_{max}$, $R_L = 2\text{ k}\Omega$		40 62	70 90 100 120	mV
I_o	Output source current	$V_{id} = 100\text{ mV}$, $V_O = V_{CC-}$ at T_{amb} at $T_{min} \leq T_{amb} \leq T_{max}$	15 5	29 5		mA
	Output sink current	$V_{id} = -100\text{ mV}$, $V_O = V_{CC+}$, at T_{amb} at $T_{min} \leq T_{amb} \leq T_{max}$	15 5	46		
I_{CC}	Supply current (per amplifier)	$V_{out} = V_{CC}/2$ $A_{VCL} = 1$, no load $T_{min} \leq T_{amb} \leq T_{max}$		120	170 200	μA
GBP	Gain bandwidth product	$R_L = 10\text{ k}\Omega$, $C_L = 100\text{ pF}$, $f = 100\text{ kHz}$	300	530		kHz
SR	Slew rate	$R_L = 10\text{ k}\Omega$, $C_L = 100\text{ pF}$, $A_V = 1$	0.1	0.18		$\text{V}/\mu\text{s}$
ϕ_m	Phase margin	$C_L = 100\text{ pF}$		60		Degrees
e_n	Input voltage noise	$f = 1\text{ kHz}$		40		$\text{nV}/\sqrt{\text{Hz}}$
THD	Total harmonic distortion			0.01		%

1. All parameter limits at temperatures other than 25°C are guaranteed by correlation.
2. Maximum values include unavoidable inaccuracies of the industrial tests.

Table 5. Electrical characteristics measured at $V_{CC+} = +3\text{ V}$, $V_{CC-} = 0\text{ V}$, with C_L and R_L connected to $V_{CC}/2$, $T_{amb} = 25^\circ\text{C}$ (unless otherwise specified) ⁽¹⁾

Symbol	Parameter	Conditions	Min.	Typ.	Max.	Unit
V_{io}	Input offset voltage	$V_{icm} = V_{out} = V_{CC}/2$ TS1851/2/4 $T_{min} \leq T_{amb} \leq T_{max}$ TS1851A/2A/4A $T_{min} \leq T_{amb} \leq T_{max}$		0.1	3 6 1 1.5	mV
ΔV_{io}	Input offset voltage drift			2		$\mu\text{V}/^\circ\text{C}$
I_{io}	Input offset current	$V_{icm} = V_{out} = V_{CC}/2^{(2)}$ $T_{min} \leq T_{amb} \leq T_{max}$		1	9 25	nA
I_{ib}	Input bias current	$V_{icm} = V_{out} = V_{CC}/2^{(2)}$ $T_{min} \leq T_{amb} \leq T_{max}$		10	55 85	nA
CMR	Common mode rejection ratio $20 \log (\Delta V_{ic}/\Delta V_{io})$	$0 \leq V_{icm} \leq V_{CC}$ $T_{min} \leq T_{amb} \leq T_{max}$	60 57	90		dB
A_{vd}	Large signal voltage gain	$V_{out} = 0.5 \text{ to } 2.5\text{ V}$ $R_L = 10\text{ k}\Omega$ $R_L = 2\text{ k}\Omega$	83 74	102 102		dB
V_{OH}	High level output voltage	$V_{id} = 100\text{ mV}$ $R_L = 10\text{ k}\Omega$ $R_L = 2\text{ k}\Omega$ $T_{min} \leq T_{amb} \leq T_{max}, R_L = 10\text{ k}\Omega$ $T_{min} \leq T_{amb} \leq T_{max}, R_L = 2\text{ k}\Omega$	2.9 2.85 2.9 2.85	2.96 2.94		V
V_{OL}	Low level output voltage	$V_{id} = -100\text{ mV}$ $R_L = 10\text{ k}\Omega$ $R_L = 2\text{ k}\Omega$ $T_{min} \leq T_{amb} \leq T_{max}, R_L = 10\text{ k}\Omega$ $T_{min} \leq T_{amb} \leq T_{max}, R_L = 2\text{ k}\Omega$		10 46	90 100 120 130	mV
I_o	Output source current	$V_{id} = 100\text{ mV}, V_O = V_{CC-}, \text{ at } T_{amb}$	15	47		mA
		At $T_{min} \leq T_{amb} \leq T_{max}$	5			
	Output sink current	$V_{id} = -100\text{ mV}, V_O = V_{CC+}, \text{ at } T_{amb}$	15	47		mA
		At $T_{min} \leq T_{amb} \leq T_{max}$	5			
I_{CC}	Supply current (per amplifier)	$V_{out} = V_{CC}/2$ $A_{VCL} = 1, \text{ no load}$ $T_{min} \leq T_{amb} \leq T_{max}$		150	200 230	μA
GBP	Gain bandwidth product	$R_L = 10\text{ k}\Omega, C_L = 100\text{ pF}, f = 100\text{ kHz}$	370	600		kHz
SR	Slew rate	$R_L = 10\text{ k}\Omega, C_L = 100\text{ pF}, A_V = 1$	0.12	0.2		$\text{V}/\mu\text{s}$
ϕ_m	Phase margin	$C_L = 100\text{ pF}$		60		Degrees
e_n	Input voltage noise	$f = 1\text{ kHz}$		40		$\text{nV}/\sqrt{\text{Hz}}$
THD	Total harmonic distortion	$V_{out} = 2\text{ V}_{pk-pk}, A_V = -1, f = 1\text{ kHz}$		0.005		%

1. All parameter limits at temperatures other than 25°C are guaranteed by correlation.
2. Maximum values include unavoidable inaccuracies of the industrial tests.

Table 6. Electrical characteristics measured at $V_{CC+} = +5\text{ V}$, $V_{CC-} = 0\text{ V}$, with C_L and R_L connected to $V_{CC}/2$, $T_{amb} = 25^\circ\text{C}$ (unless otherwise specified) ⁽¹⁾

Symbol	Parameter	Conditions	Min.	Typ.	Max.	Unit
V_{io}	Input offset voltage	$V_{icm} = V_{out} = V_{CC}/2$ TS1851/2/4 $T_{min} \leq T_{amb} \leq T_{max}$ TS1851A/2A/4A $T_{min} \leq T_{amb} \leq T_{max}$		0.1	3 6 1 1.5	mV
ΔV_{io}	Input offset voltage drift			2		$\mu\text{V}/^\circ\text{C}$
I_{io}	Input offset current	$V_{icm} = V_{out} = V_{CC}/2^{(2)}$ $T_{min} \leq T_{amb} \leq T_{max}$		1	9 25	nA
I_{ib}	Input bias current	$V_{icm} = V_{out} = V_{CC}/2^{(2)}$ $T_{min} \leq T_{amb} \leq T_{max}$		16	63 93	nA
CMR	Common mode rejection ratio $20 \log (\Delta V_{ic}/\Delta V_{io})$	$0 \leq V_{icm} \leq V_{CC}$ $T_{min} \leq T_{amb} \leq T_{max}$	65 62	95		dB
SVR	Supply voltage rejection ratio $20 \log (\Delta V_{CC}/\Delta V_{io})$	$V_{CC} = 1.8 \text{ to } 5\text{ V}$	70	90		dB
A_{vd}	Large signal voltage gain	$V_{out} = 0.5 \text{ to } 4\text{ V}$ $R_L = 10\text{ k}\Omega$ $R_L = 2\text{ k}\Omega$	85 77	104 104		dB
V_{OH}	High level output voltage	$V_{id} = 100\text{ mV}$ $R_L = 10\text{ k}\Omega$ $R_L = 2\text{ k}\Omega$ $T_{min} \leq T_{amb} \leq T_{max}, R_L = 10\text{ k}\Omega$ $T_{min} \leq T_{amb} \leq T_{max}, R_L = 2\text{ k}\Omega$	4.85 4.8 4.85 4.8	4.95 4.91		V
V_{OL}	Low level output voltage	$V_{id} = -100\text{ mV}$ $R_L = 10\text{ k}\Omega$ $R_L = 2\text{ k}\Omega$ $T_{min} \leq T_{amb} \leq T_{max}, R_L = 10\text{ k}\Omega$ $T_{min} \leq T_{amb} \leq T_{max}, R_L = 2\text{ k}\Omega$		40 80	180 200 180 200	mV
I_o	Output source current	$V_{id} = 100\text{ mV}, V_O = V_{CC-}$, at T_{amb} at $T_{min} \leq T_{amb} \leq T_{max}$	15 5	48		mA
	Output sink current	$V_{id} = -100\text{ mV}, V_O = V_{CC+}$, at T_{amb} at $T_{min} \leq T_{amb} \leq T_{max}$	15 5	48		
I_{CC}	Supply current (per amplifier)	$V_{out} = V_{CC}/2$ $A_{VCL} = 1$, no load $T_{min} \leq T_{amb} \leq T_{max}$		162	220 250	μA
GBP	Gain bandwidth product	$R_L = 10\text{ k}\Omega, C_L = 100\text{ pF}, f = 100\text{ kHz}$	380	656		kHz
SR	Slew rate	$R_L = 10\text{ k}\Omega, C_L = 100\text{ pF}, A_V = 1$	0.13	0.25		$\text{V}/\mu\text{s}$
ϕ_m	Phase margin	$C_L = 100\text{ pF}$		60		Degrees
e_n	Input voltage noise	$f = 1\text{ kHz}$		40		$\text{nV}/\sqrt{\text{Hz}}$
THD	Total harmonic distortion	$V_{out} = 2\text{ V}_{pk-pk}, A_V = -1, f = 1\text{ kHz}$		0.01		%

1. All parameter limits at temperatures other than 25°C are guaranteed by correlation.
2. Maximum values include unavoidable inaccuracies of the industrial tests.

Figure 1. Input offset voltage distribution

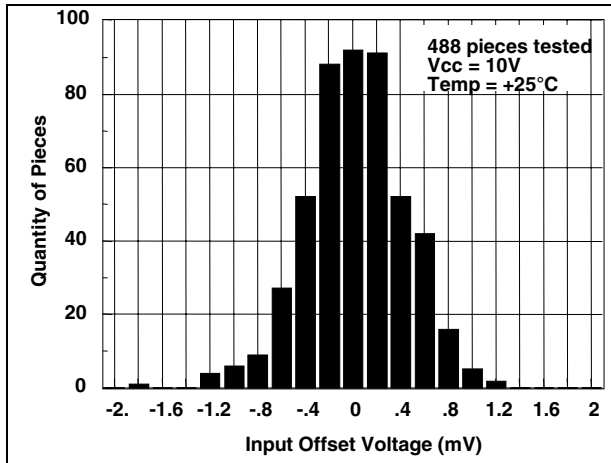

Figure 2. Input offset voltage vs. temperature

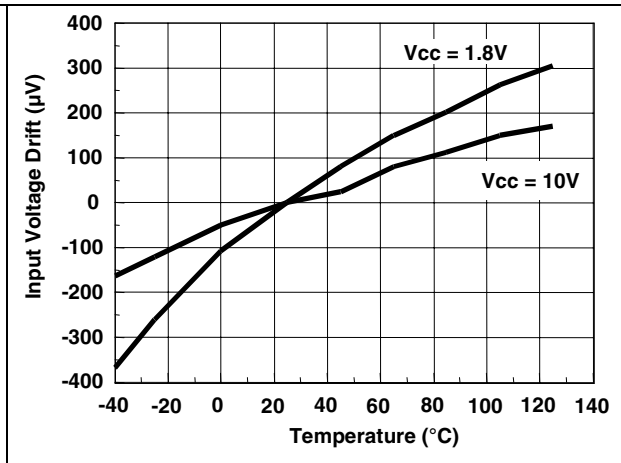

Figure 3. Input bias current vs. temperature at Vcc = 1.8 V

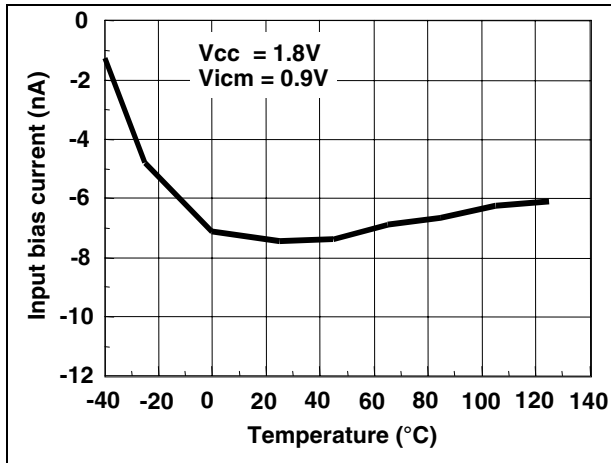

Figure 4. Input bias current vs. temperature at Vcc = 3 V

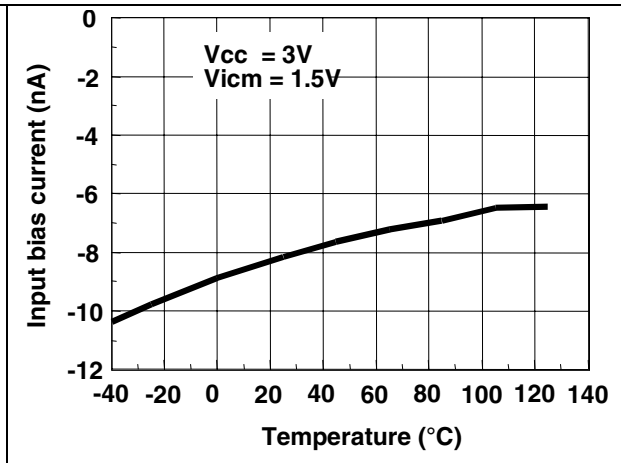

Figure 5. Input bias current vs. temperature at Vcc = 5 V

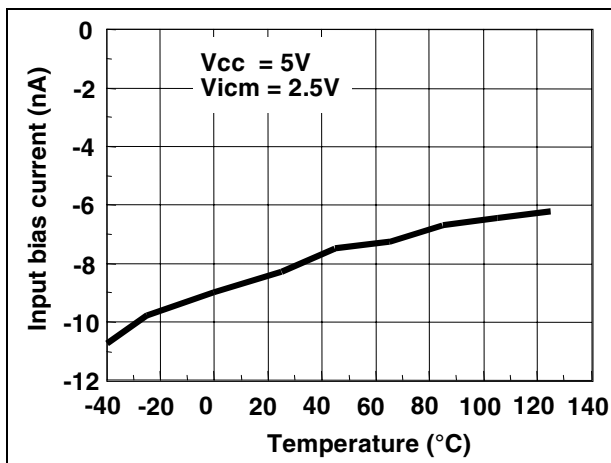

Figure 6. Supply current/amplifier vs. supply voltage

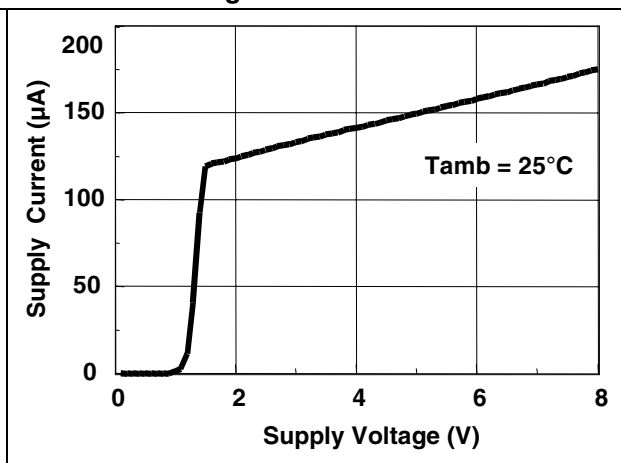

Figure 7. Supply current/amplifier vs. temperature

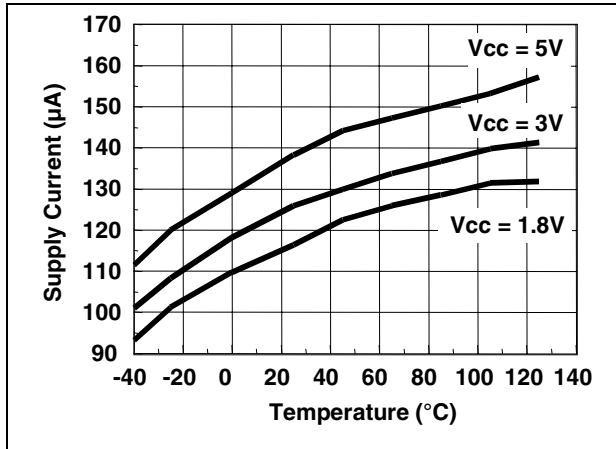

Figure 8. Common mode rejection vs. temperature at Vcc = 1.8 V

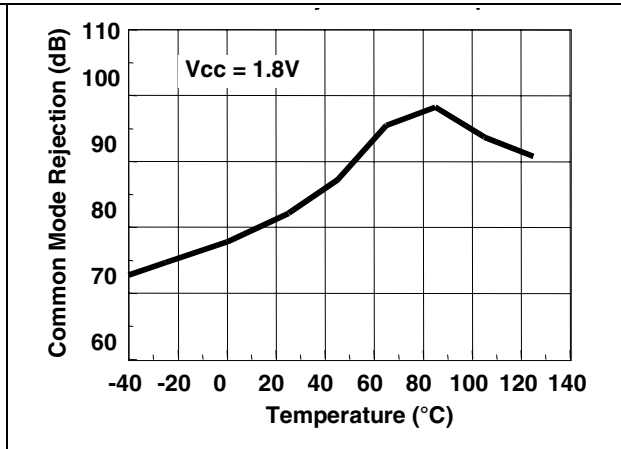

Figure 9. Common mode rejection vs. temperature at Vcc = 3 V

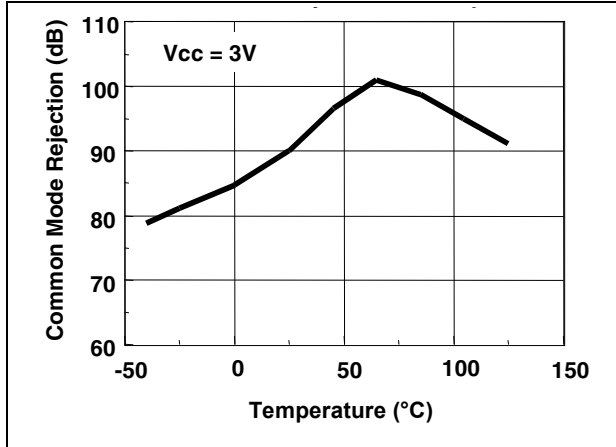

Figure 10. Common mode rejection vs. temperature at Vcc = 5 V

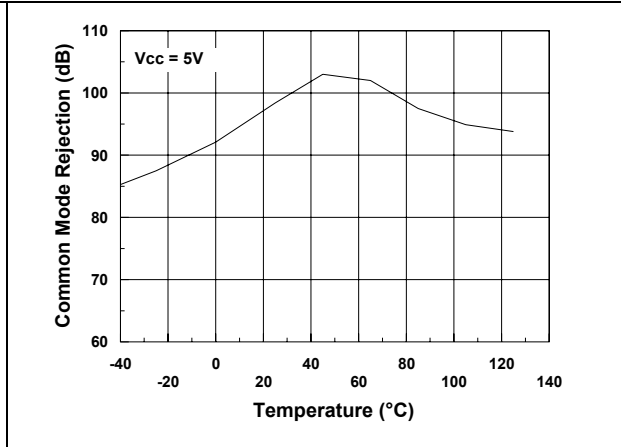

Figure 11. Supply voltage rejection vs. temperature at Vcc = 2 V

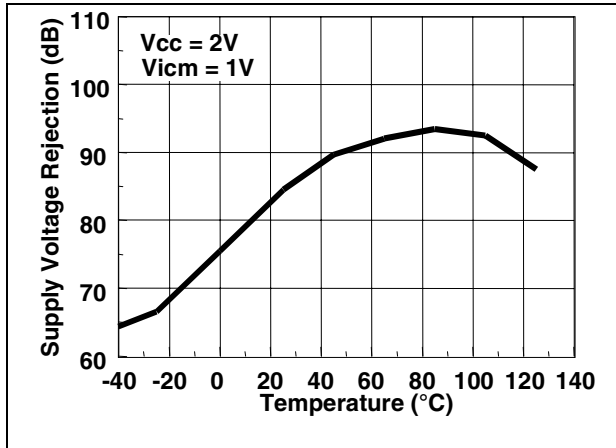

Figure 12. Supply voltage rejection vs. temperature at Vcc = 3 V

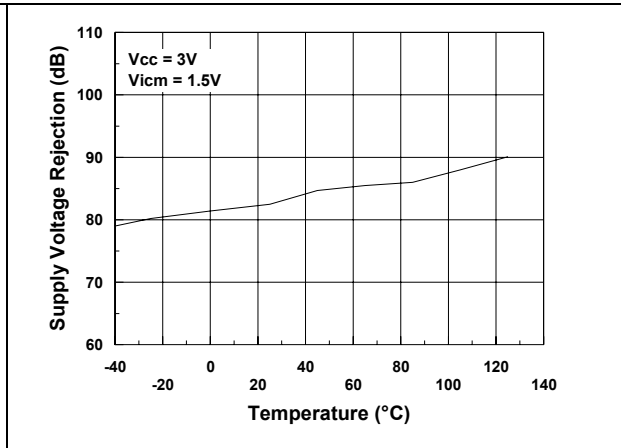

Figure 13. Supply voltage rejection vs. temperature at $V_{CC} = 5\text{ V}$

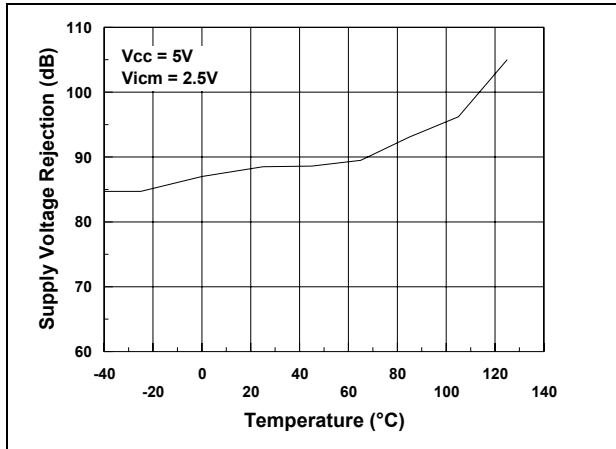

Figure 14. Open loop gain vs. temperature at $V_{CC} = 1.8\text{ V}$

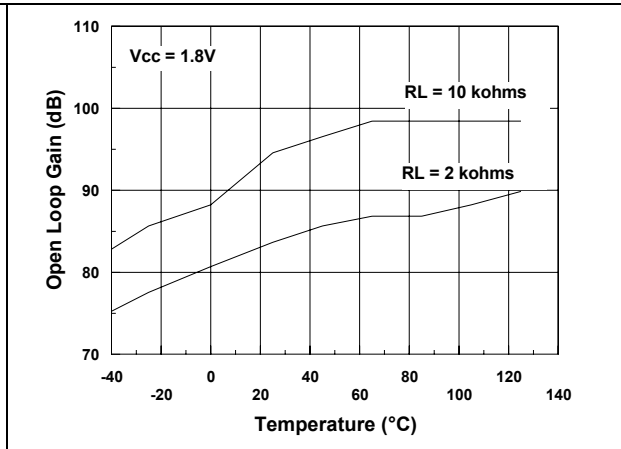

Figure 15. Open loop gain vs. temperature at $V_{CC} = 3\text{ V}$

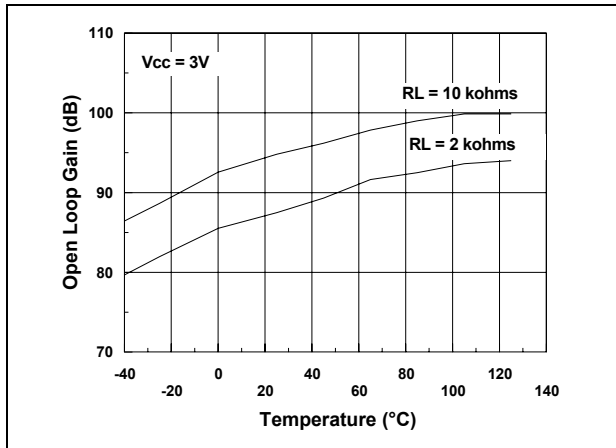

Figure 16. Open loop gain vs. temperature at $V_{CC} = 5\text{ V}$

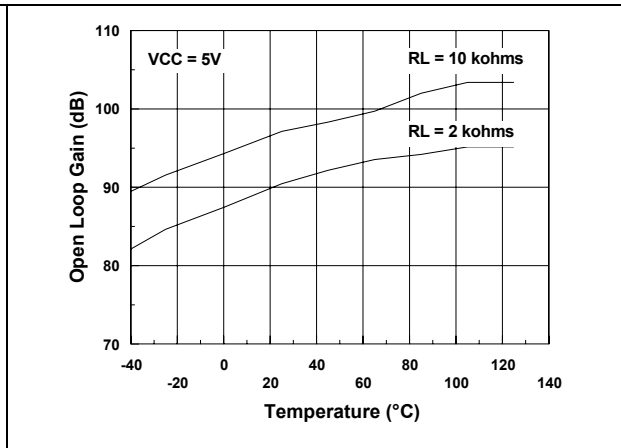

Figure 17. High level output voltage vs. temperature, $R_L = 10\text{ k}\Omega$

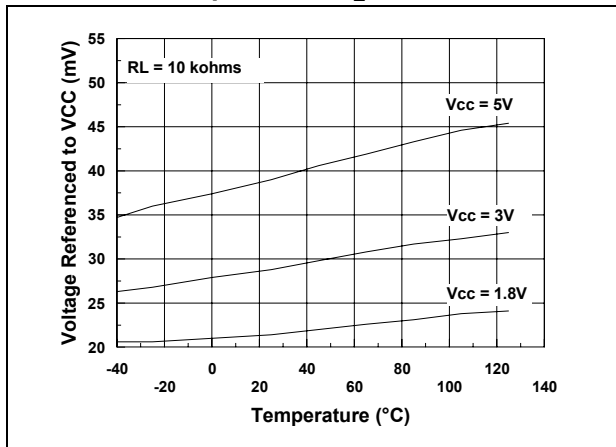

Figure 18. Low level output voltage vs. temperature, $R_L = 10\text{ k}\Omega$

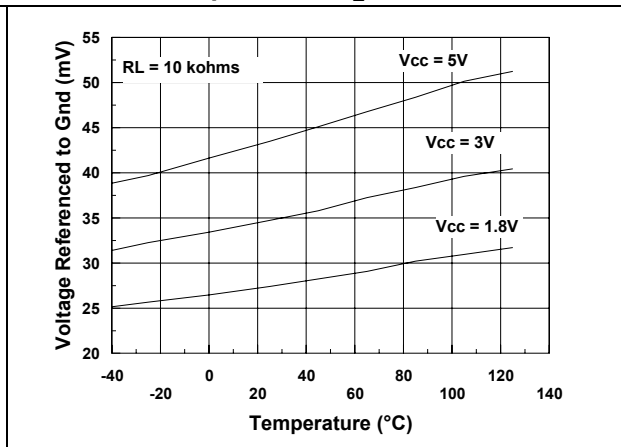

Figure 19. High level output voltage vs. temperature, $R_L = 2\text{ k}\Omega$

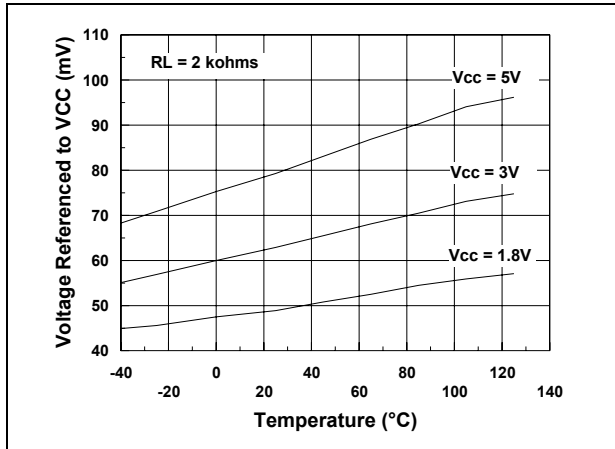

Figure 20. Low level output voltage vs. temperature, $R_L = 2\text{ k}\Omega$

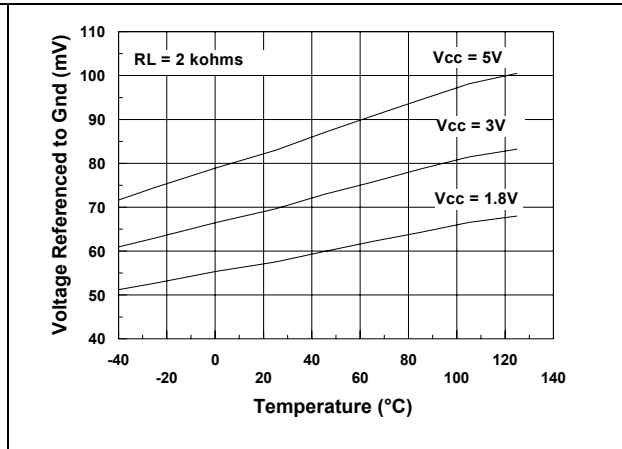

Figure 21. Output current vs. temperature

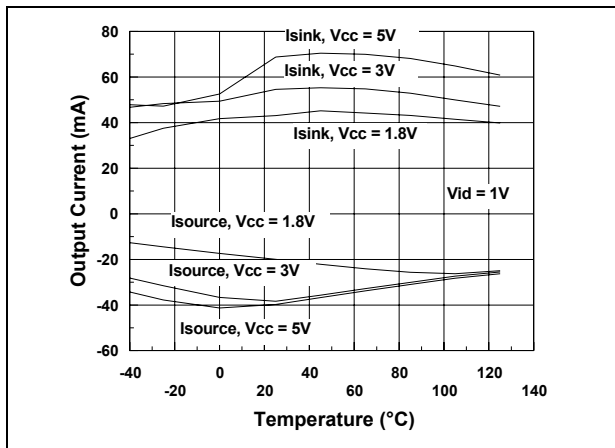

Figure 22. Output current vs. output voltage at $V_{CC} = 1.8\text{ V}$

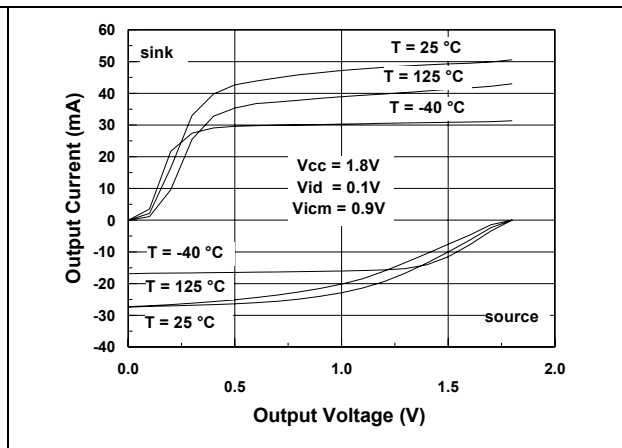

Figure 23. Output current vs. output voltage at $V_{CC} = 3\text{ V}$

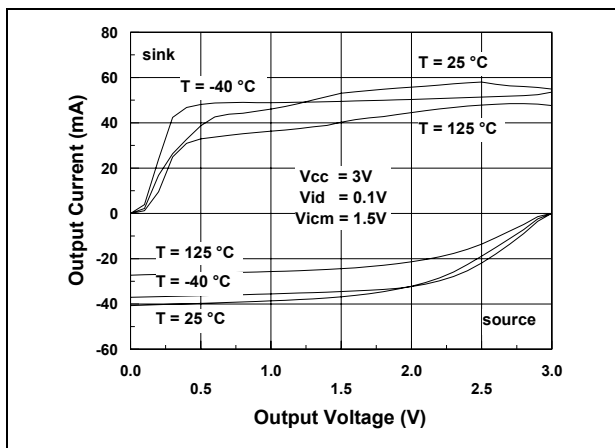

Figure 24. Output current vs. output voltage at $V_{CC} = 5\text{ V}$

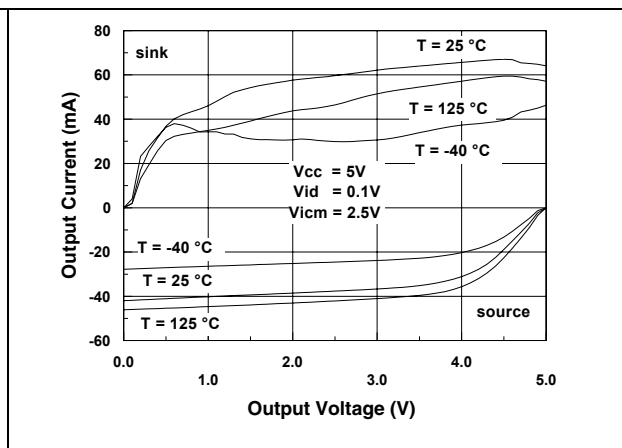

Figure 25. Gain and phase vs. frequency at $V_{CC} = 1.8\text{ V}$

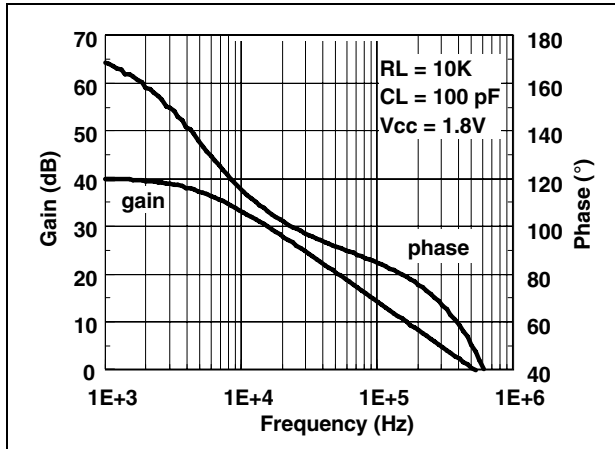

Figure 26. Gain and phase vs. frequency at $V_{CC} = 5\text{ V}$

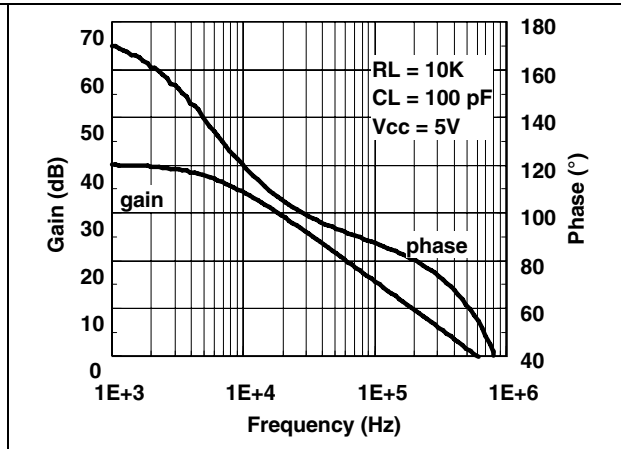

Figure 27. Gain bandwidth product vs. temperature

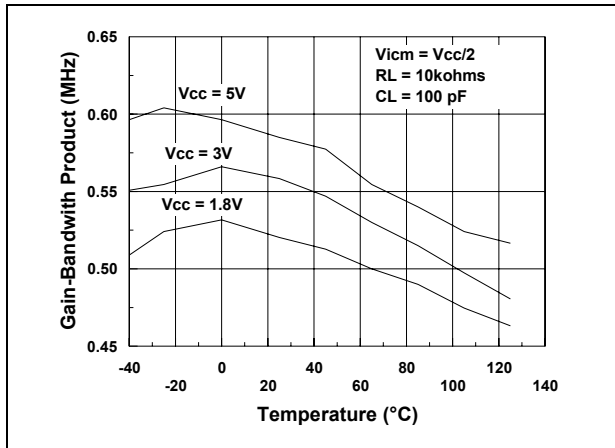

Figure 28. Gain bandwidth product vs. supply voltage

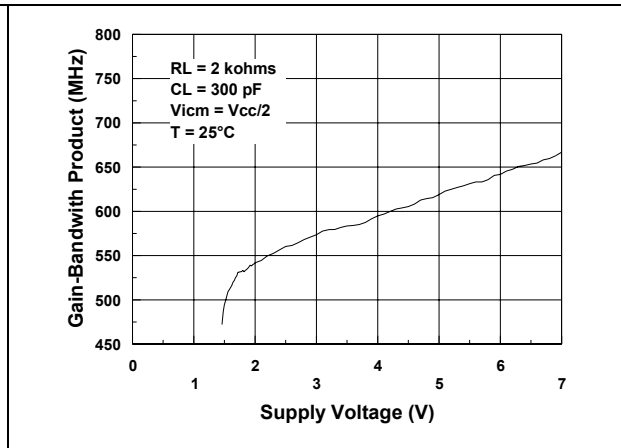

Figure 29. Slew rate vs. temperature at $V_{CC} = 1.8\text{ V}$

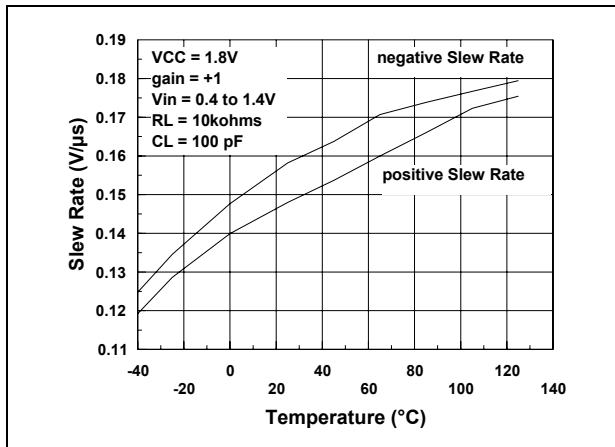

Figure 30. Slew rate vs. temperature at $V_{CC} = 3\text{ V}$

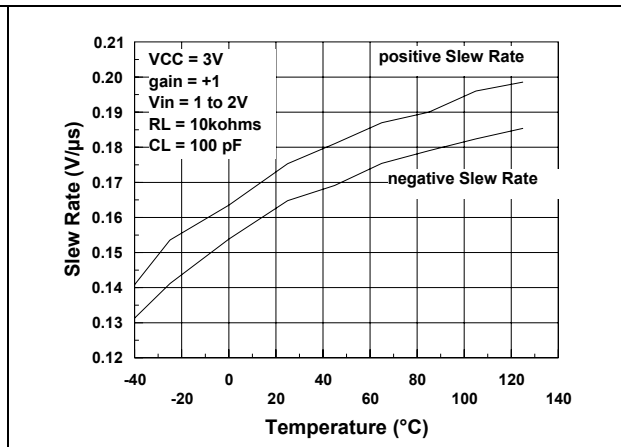

Figure 31. Slew rate vs. temperature at $V_{CC} = 5\text{ V}$

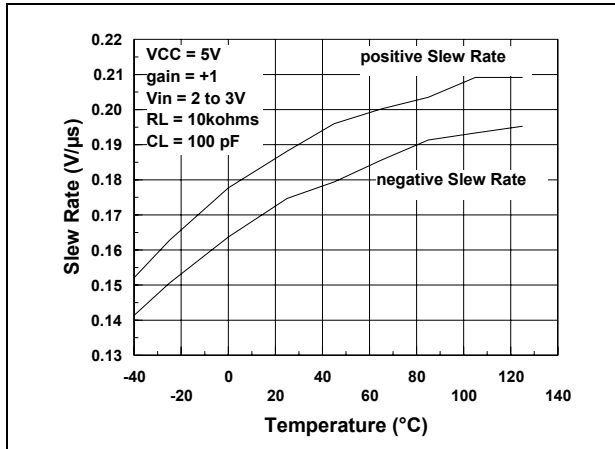

Figure 32. Phase margin vs. load capacitor

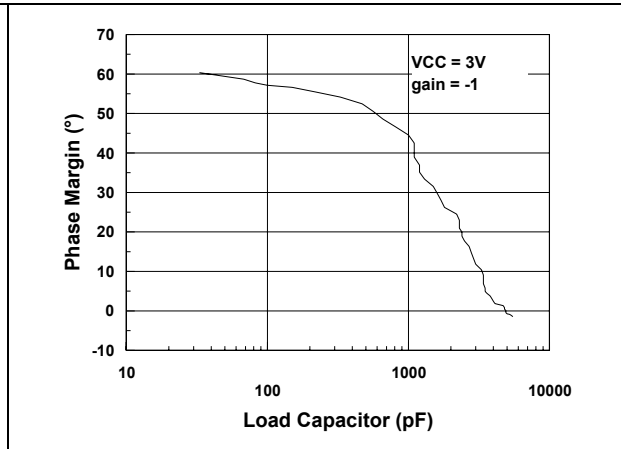

Figure 33. Phase margin vs. output current

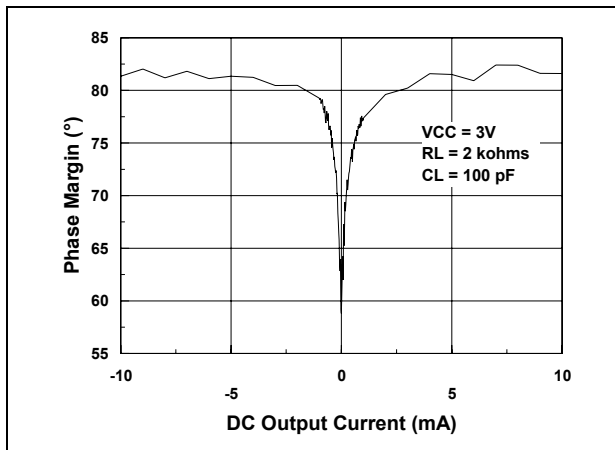

Figure 34. Equivalent input noise vs. frequency

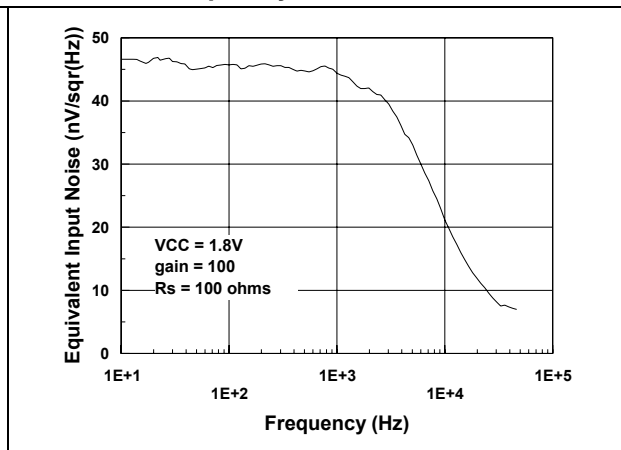

Figure 35. Distortion vs. output voltage at $V_{CC} = 1.8\text{ V}$

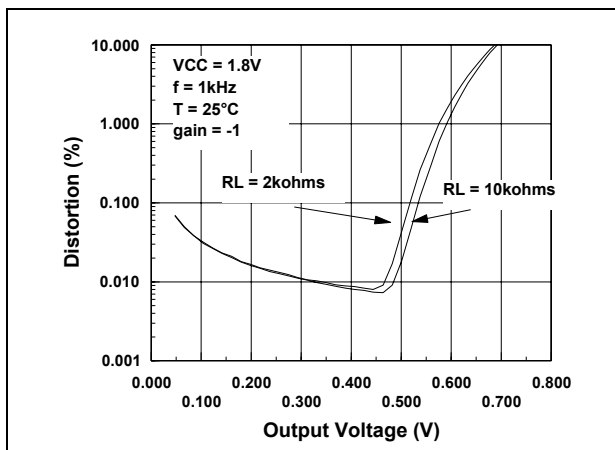

Figure 36. Distortion vs. output voltage at $V_{CC} = 3\text{ V}$

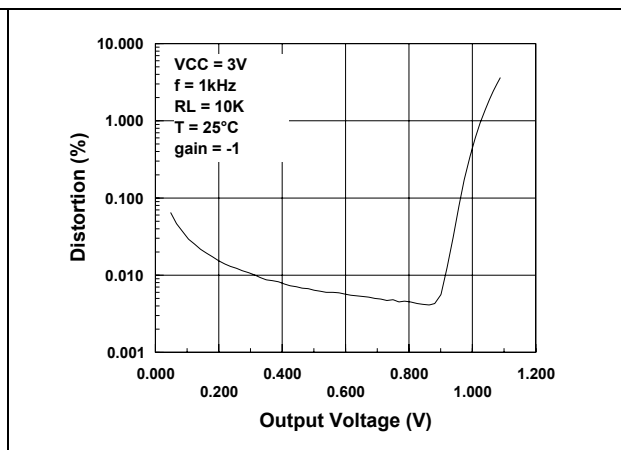

Figure 37. Distortion vs. output voltage at $V_{CC} = 5\text{ V}$

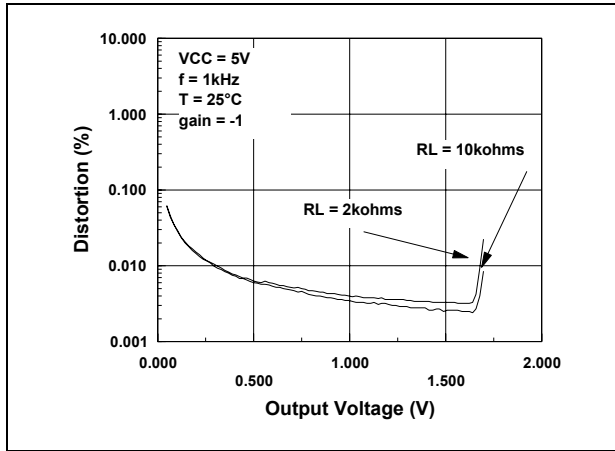
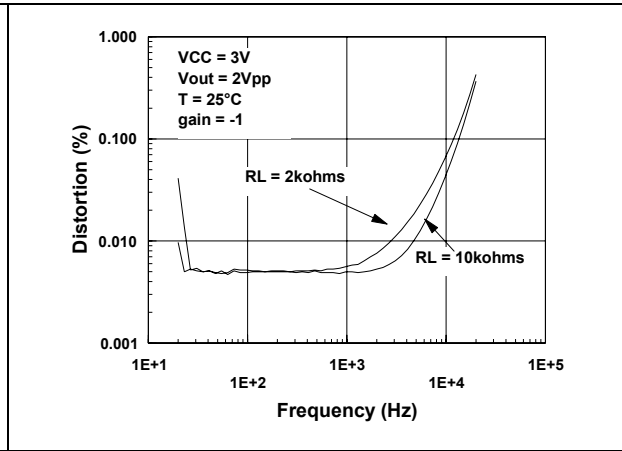

Figure 38. Distortion vs. frequency



3 Package information

In order to meet environmental requirements, ST offers these devices in different grades of ECOPACK[®] packages, depending on their level of environmental compliance. ECOPACK[®] specifications, grade definitions and product status are available at: www.st.com. ECOPACK[®] is an ST trademark.

3.1 SO-8 package information

Figure 39. SO-8 package mechanical drawing

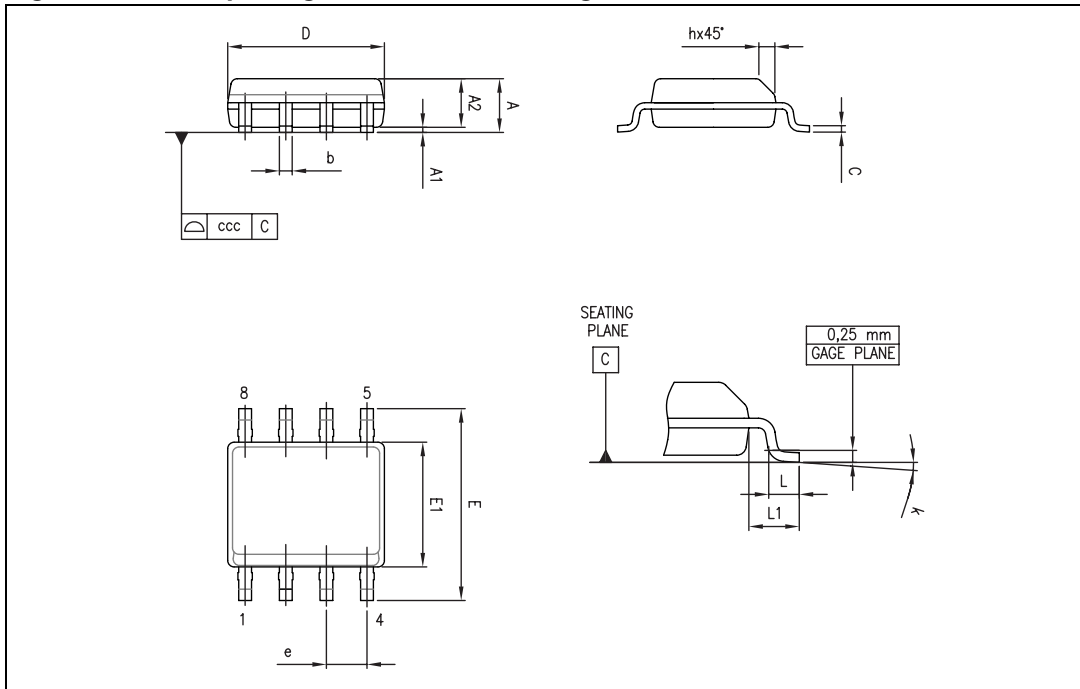

Table 7. SO-8 package mechanical data

Ref.	Dimensions					
	Millimeters			Inches		
	Min.	Typ.	Max.	Min.	Typ.	Max.
A			1.75			0.069
A1	0.10		0.25	0.004		0.010
A2	1.25			0.049		
b	0.28		0.48	0.011		0.019
c	0.17		0.23	0.007		0.010
D	4.80	4.90	5.00	0.189	0.193	0.197
E	5.80	6.00	6.20	0.228	0.236	0.244
E1	3.80	3.90	4.00	0.150	0.154	0.157
e		1.27			0.050	
h	0.25		0.50	0.010		0.020
L	0.40		1.27	0.016		0.050
L1		1.04			0.040	
k	1°		8°	1°		8°
ccc			0.10			0.004

3.2 TSSOP8 package information

Figure 40. TSSOP8 package mechanical drawing

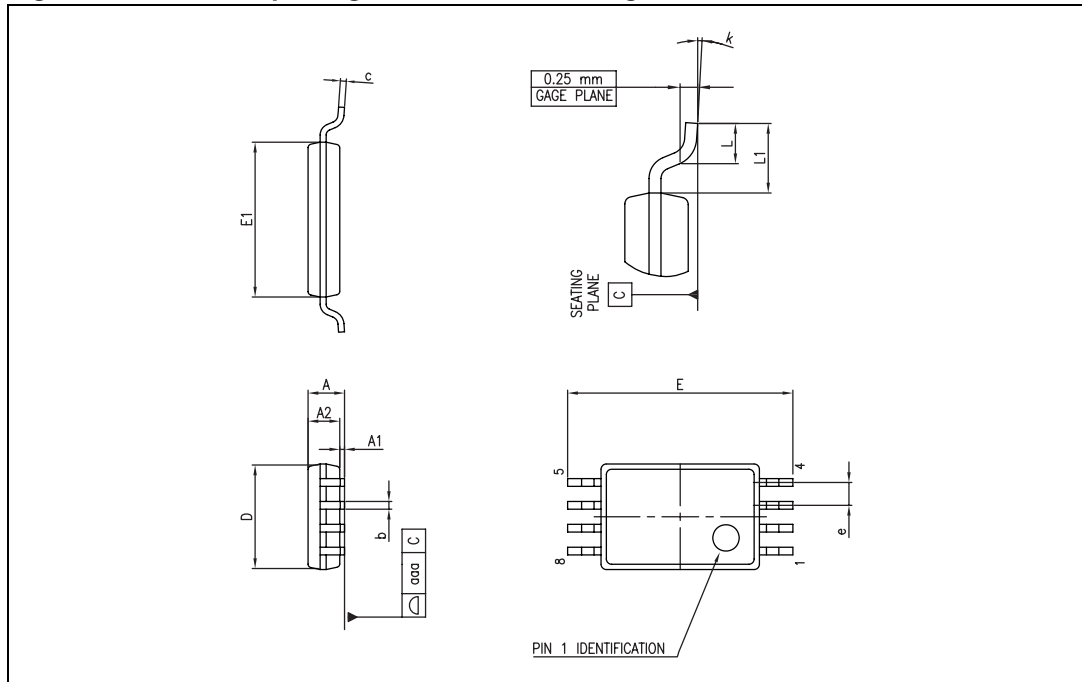

Table 8. TSSOP8 package mechanical data

Ref.	Dimensions					
	Millimeters			Inches		
	Min.	Typ.	Max.	Min.	Typ.	Max.
A			1.20			0.047
A1	0.05		0.15	0.002		0.006
A2	0.80	1.00	1.05	0.031	0.039	0.041
b	0.19		0.30	0.007		0.012
c	0.09		0.20	0.004		0.008
D	2.90	3.00	3.10	0.114	0.118	0.122
E	6.20	6.40	6.60	0.244	0.252	0.260
E1	4.30	4.40	4.50	0.169	0.173	0.177
e		0.65			0.0256	
k	0°		8°	0°		8°
L	0.45	0.60	0.75	0.018	0.024	0.030
L1		1			0.039	
aaa			0.10			0.004

3.3 MiniSO-8 package information

Figure 41. MiniSO-8 package mechanical drawing

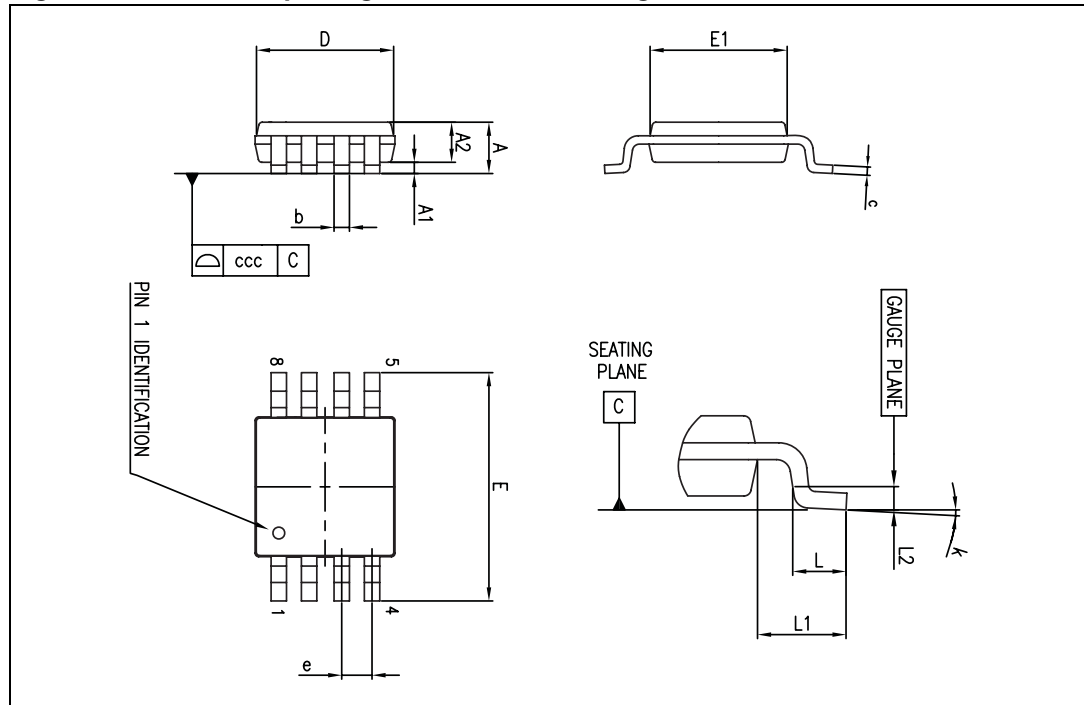

Table 9. MiniSO-8 package mechanical data

Ref.	Dimensions					
	Millimeters			Inches		
	Min.	Typ.	Max.	Min.	Typ.	Max.
A			1.1			0.043
A1	0		0.15	0		0.006
A2	0.75	0.85	0.95	0.030	0.033	0.037
b	0.22		0.40	0.009		0.016
c	0.08		0.23	0.003		0.009
D	2.80	3.00	3.20	0.11	0.118	0.126
E	4.65	4.90	5.15	0.183	0.193	0.203
E1	2.80	3.00	3.10	0.11	0.118	0.122
e		0.65			0.026	
L	0.40	0.60	0.80	0.016	0.024	0.031
L1		0.95			0.037	
L2		0.25			0.010	
k	0°		8°	0°		8°
ccc			0.10			0.004

3.4 SO-14 package information

Figure 42. SO-14 package mechanical drawing

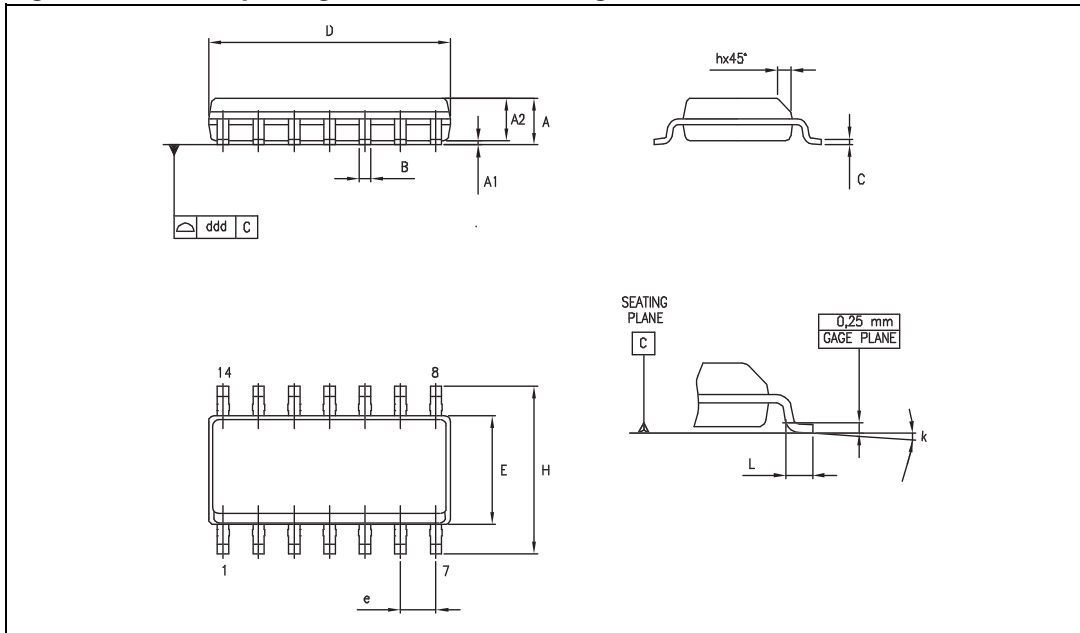

Table 10. SO-14 package mechanical data

Dimensions						
Ref.	Millimeters			Inches		
	Min.	Typ.	Max.	Min.	Typ.	Max.
A	1.35		1.75	0.05		0.068
A1	0.10		0.25	0.004		0.009
A2	1.10		1.65	0.04		0.06
B	0.33		0.51	0.01		0.02
C	0.19		0.25	0.007		0.009
D	8.55		8.75	0.33		0.34
E	3.80		4.0	0.15		0.15
e		1.27			0.05	
H	5.80		6.20	0.22		0.24
h	0.25		0.50	0.009		0.02
L	0.40		1.27	0.015		0.05
k	8° (max.)					
ddd			0.10			0.004

3.5 TSSOP14 package information

Figure 43. TSSOP14 package mechanical drawing

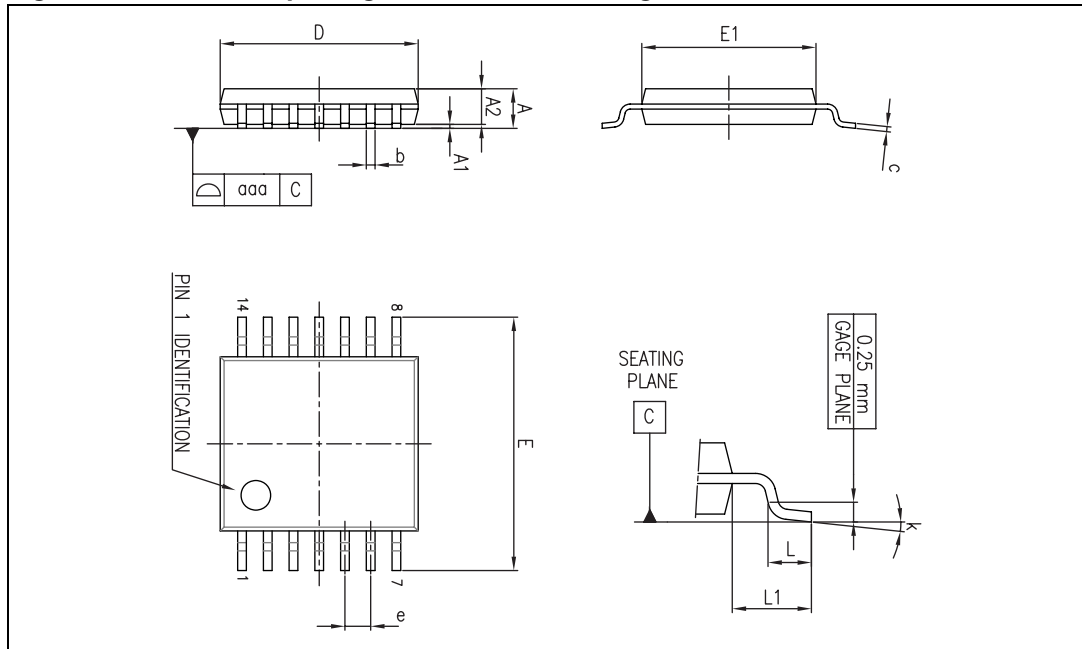

Table 11. TSSOP14 package mechanical data

Ref.	Dimensions					
	Millimeters			Inches		
	Min.	Typ.	Max.	Min.	Typ.	Max.
A			1.20			0.047
A1	0.05		0.15	0.002	0.004	0.006
A2	0.80	1.00	1.05	0.031	0.039	0.041
b	0.19		0.30	0.007		0.012
c	0.09		0.20	0.004		0.0089
D	4.90	5.00	5.10	0.193	0.197	0.201
E	6.20	6.40	6.60	0.244	0.252	0.260
E1	4.30	4.40	4.50	0.169	0.173	0.176
e		0.65			0.0256	
L	0.45	0.60	0.75	0.018	0.024	0.030
L1		1.00			0.039	
k	0°		8°	0°		8°
aaa			0.10			0.004

3.6 SOT23-5 package information

Figure 44. SOT23-5L package mechanical drawing

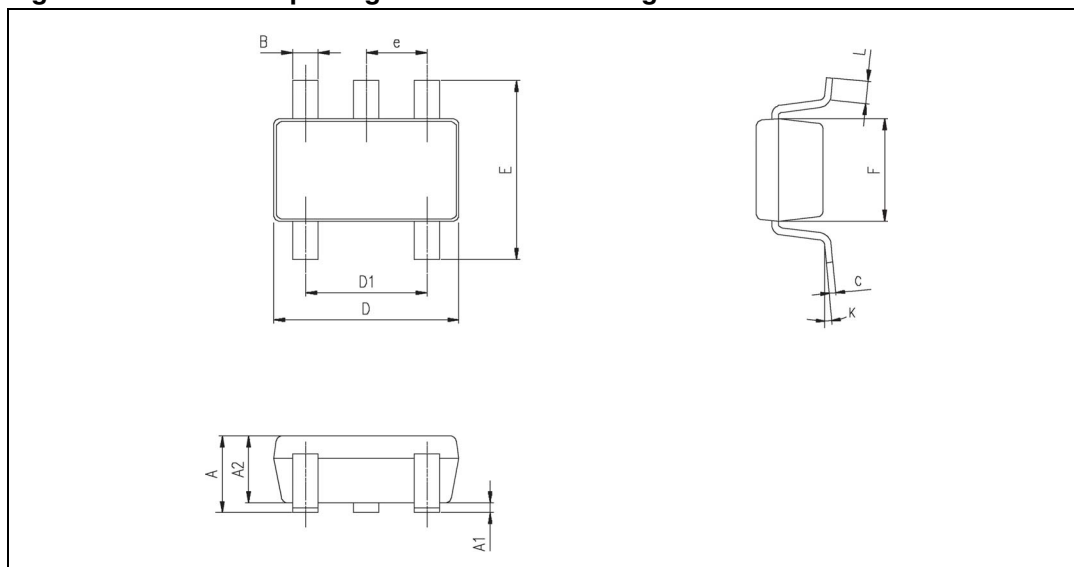

Table 12. SOT23-5L package mechanical data

Ref.	Dimensions					
	Millimeters			Inches		
	Min.	Typ.	Max.	Min.	Typ.	Max.
A	0.90	1.20	1.45	0.035	0.047	0.057
A1			0.15			0.006
A2	0.90	1.05	1.30	0.035	0.041	0.051
B	0.35	0.40	0.50	0.013	0.015	0.019
C	0.09	0.15	0.20	0.003	0.006	0.008
D	2.80	2.90	3.00	0.110	0.114	0.118
D1		1.90			0.075	
e		0.95			0.037	
E	2.60	2.80	3.00	0.102	0.110	0.118
F	1.50	1.60	1.75	0.059	0.063	0.069
L	0.10	0.35	0.60	0.004	0.013	0.023
K	0°		10°			

4 Ordering information

Table 13. Order codes

Order code	Temperature range	Package	Packing	Marking
TS1851ID/IDT	-40°C to +125°C	SO-8	Tube or tape & reel	1851I
TS1851AID/AIDT				1851AI
TS1851ILT		SOT23-5L	Tape & reel	K161
TS1851AILT				K162
TS1852ID/IDT		SO-8	Tube or tape & reel	1852I
TS1852AID/AIDT				1852AI
TS1852IPT		TSSOP8 (Thin shrink outline package)	Tape & reel	1852I
TS1852AIPT				1852A
TS1852IST		MiniSO-8	Tape & reel	K161
TS1852AIST				K162
TS1854ID/IDT		SO-14	Tube or tape & reel	1854I
TS1854AID/AIDT				1854AI
TS1854IPT		TSSOP14 (Thin shrink outline package)	Tape & reel	1854I
TS1854AIPT				1854A

5 Revision history

Table 14. Document revision history

Date	Revision	Changes
01-Feb-2002	1	First release.
01-May-2005	2	Modifications on AMR Table 2 on page 3 (explanation of V_{id} and V_i limits)
22-May-2007	3	Added limits in temperature in Table 4 , Table 5 , and Table 6 . Added SVR in Table 6 (SVR parameter removed from Table 4 and Table 5). Added equivalent input voltage noise in Table 4 , Table 5 , and Table 6 . Added R_{thjc} values in Table 2 on page 3 . Updated Table 13: Order codes .
12-Mar-2010	4	Updated document format. Modified headings, added root part number TS185xA and added Table 1: Device summary on cover page. Modified Iout parameters in temperature, added limits at Tamb and improved typical values of A_{vd} in Table 4 , Table 5 and Table 6 . Updated package information in Chapter 3 . Removed order codes for DIP package from Table 13 .

Please Read Carefully:

Information in this document is provided solely in connection with ST products. STMicroelectronics NV and its subsidiaries ("ST") reserve the right to make changes, corrections, modifications or improvements, to this document, and the products and services described herein at any time, without notice.

All ST products are sold pursuant to ST's terms and conditions of sale.

Purchasers are solely responsible for the choice, selection and use of the ST products and services described herein, and ST assumes no liability whatsoever relating to the choice, selection or use of the ST products and services described herein.

No license, express or implied, by estoppel or otherwise, to any intellectual property rights is granted under this document. If any part of this document refers to any third party products or services it shall not be deemed a license grant by ST for the use of such third party products or services, or any intellectual property contained therein or considered as a warranty covering the use in any manner whatsoever of such third party products or services or any intellectual property contained therein.

UNLESS OTHERWISE SET FORTH IN ST'S TERMS AND CONDITIONS OF SALE ST DISCLAIMS ANY EXPRESS OR IMPLIED WARRANTY WITH RESPECT TO THE USE AND/OR SALE OF ST PRODUCTS INCLUDING WITHOUT LIMITATION IMPLIED WARRANTIES OF MERCHANTABILITY, FITNESS FOR A PARTICULAR PURPOSE (AND THEIR EQUIVALENTS UNDER THE LAWS OF ANY JURISDICTION), OR INFRINGEMENT OF ANY PATENT, COPYRIGHT OR OTHER INTELLECTUAL PROPERTY RIGHT.

UNLESS EXPRESSLY APPROVED IN WRITING BY AN AUTHORIZED ST REPRESENTATIVE, ST PRODUCTS ARE NOT RECOMMENDED, AUTHORIZED OR WARRANTED FOR USE IN MILITARY, AIR CRAFT, SPACE, LIFE SAVING, OR LIFE SUSTAINING APPLICATIONS, NOR IN PRODUCTS OR SYSTEMS WHERE FAILURE OR MALFUNCTION MAY RESULT IN PERSONAL INJURY, DEATH, OR SEVERE PROPERTY OR ENVIRONMENTAL DAMAGE. ST PRODUCTS WHICH ARE NOT SPECIFIED AS "AUTOMOTIVE GRADE" MAY ONLY BE USED IN AUTOMOTIVE APPLICATIONS AT USER'S OWN RISK.

Resale of ST products with provisions different from the statements and/or technical features set forth in this document shall immediately void any warranty granted by ST for the ST product or service described herein and shall not create or extend in any manner whatsoever, any liability of ST.

ST and the ST logo are trademarks or registered trademarks of ST in various countries.

Information in this document supersedes and replaces all information previously supplied.

The ST logo is a registered trademark of STMicroelectronics. All other names are the property of their respective owners.

© 2010 STMicroelectronics - All rights reserved



STMicroelectronics group of companies

Australia - Belgium - Brazil - Canada - China - Czech Republic - Finland - France - Germany - Hong Kong - India - Israel - Italy - Japan - Malaysia - Malta - Morocco - Philippines - Singapore - Spain - Sweden - Switzerland - United Kingdom - United States of America

www.st.com

Looking for pricing, stock, or lifecycle information?

Click below to explore more details on WIN SOURCE:

-  [View TS1852IPT](#) on WIN SOURCE
-  [STMicroelectronics](#) Information

Optimize Your Supply Chain with WIN SOURCE Solutions

-  Global Sourcing Solution
-  Obsolete Management
-  Cost Control Management
-  Shortage Management
-  Alternative Solution
-  Excess Inventory Management