



**THE DATASHEET OF
TPS22924DYZPT**



TPS22924D 3.6-V, 2-A, 18.3-m Ω On-Resistance Load Switch

1 Features

- Integrated Single-Channel Load Switch
- Input Voltage: 0.75 V to 3.6 V
- On-Resistance
 - $r_{ON} = 18.3 \text{ m}\Omega$ at $V_{IN} = 3.6 \text{ V}$
 - $r_{ON} = 18.5 \text{ m}\Omega$ at $V_{IN} = 2.5 \text{ V}$
 - $r_{ON} = 19.6 \text{ m}\Omega$ at $V_{IN} = 1.8 \text{ V}$
 - $r_{ON} = 19.4 \text{ m}\Omega$ at $V_{IN} = 1.2 \text{ V}$
 - $r_{ON} = 20.3 \text{ m}\Omega$ at $V_{IN} = 1.0 \text{ V}$
 - $r_{ON} = 22.7 \text{ m}\Omega$ at $V_{IN} = 0.75 \text{ V}$
- Small CSP-6 package
0.9 mm x 1.4 mm, 0.5-mm Pitch
- 2-A Maximum Continuous Switch Current
- Low Shutdown Current
- Low Threshold Control Input
- Controlled Slew Rate to Avoid Inrush Currents
- Quick Output Discharge Transistor
- ESD Performance Tested Per JESD 22
 - 5000-V Human-Body Model (A114-B, Class II)
 - 1000-V Charged-Device Model (C101)

2 Applications

- Battery Powered Equipment
- Portable Industrial Equipment
- Portable Medical Equipment
- Portable Media Players
- Point of Sales Terminal
- GPS Devices
- Digital Cameras
- Notebooks / Tablet PCs / eReaders
- Smartphones

3 Description

The TPS22924D is a small, low R_{ON} load switch with controlled turn on. The device contains a N-channel MOSFET that can operate over an input voltage range of 0.75 V to 3.6 V. An integrated charge pump biases the NMOS switch to achieve a minimum switch ON resistance. The switch is controlled by an on/off input (ON), which is capable of interfacing directly with low-voltage control signals.

A 1250 Ω on-chip load resistor is added for output quick discharge when the switch is turned off. The rise time of the device is internally controlled to avoid inrush current. The TPS22924D features a rise time of 6200 μs at 3.6 V.

The TPS22924D is available in an ultra-small, space-saving 6-pin CSP package and is characterized for operation over the free-air temperature range of -40°C to 85°C .

Device Information (1)

PART NUMBER	PACKAGE	BODY SIZE (NOM)
TPS22924D	DSBGA (6)	0.9 mm x 1.4 mm

(1) For all available packages, see the orderable addendum at the end of the datasheet.

Typical Application Diagram

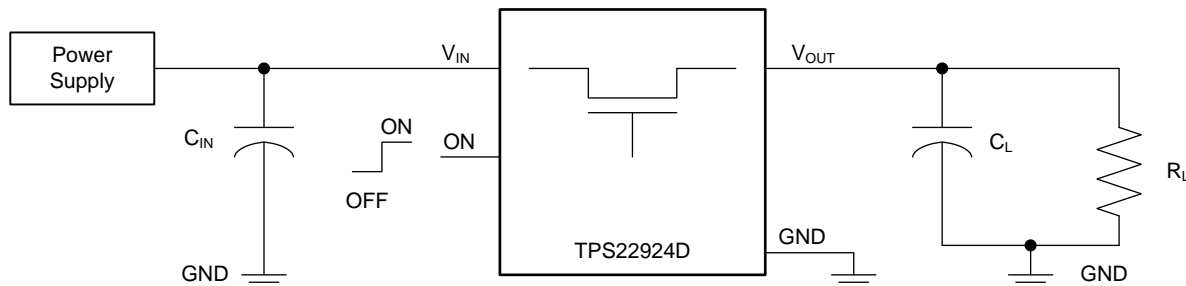

Table of Contents

1 Features	1	8.1 Overview	11
2 Applications	1	8.2 Functional Block Diagram	11
3 Description	1	8.3 Feature Description	11
4 Revision History	2	8.4 Device Functional Modes	12
5 Pin Configuration and Functions	3	9 Application and Implementation	13
6 Specifications	3	9.1 Application Information	13
6.1 Absolute Maximum Ratings	3	9.2 Typical Application	13
6.2 ESD Ratings	3	10 Power Supply Recommendations	15
6.3 Recommended Operating Conditions	4	11 Layout	15
6.4 Thermal Information	4	11.1 Layout Guidelines	15
6.5 Electrical Characteristics	4	11.2 Layout Example	15
6.6 Switching Characteristics: $V_{IN} = 3.6\text{ V}$	5	12 Device and Documentation Support	16
6.7 Switching Characteristics: $V_{IN} = 0.9\text{ V}$	5	12.1 Community Resources	16
6.8 Dissipation Ratings	5	12.2 Trademarks	16
6.9 Typical Characteristics	6	12.3 Electrostatic Discharge Caution	16
7 Parametric Measurement Information	10	12.4 Glossary	16
8 Detailed Description	11	13 Mechanical, Packaging, and Orderable Information	16

4 Revision History

NOTE: Page numbers for previous revisions may differ from page numbers in the current version.

Changes from Original (May 2013) to Revision A

Page

- Added *Pin Configuration and Functions* section, *ESD Ratings* table, *Feature Description* section, *Device Functional Modes*, *Application and Implementation* section, *Power Supply Recommendations* section, *Layout* section, *Device and Documentation Support* section, and *Mechanical, Packaging, and Orderable Information* section **1**

5 Pin Configuration and Functions

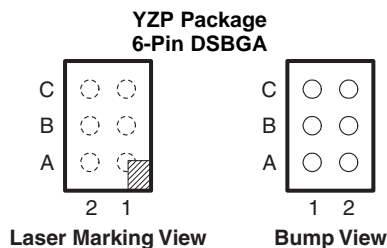

Pin Assignments (YZP Package)

C	GND	ON
B	VOUT	VIN
A	VOUT	VIN
	1	2

Pin Functions

PIN		I/O	DESCRIPTION
NAME	NO.		
GND	C1	—	Ground
ON	C2	I	Switch control input, active high. Do not leave floating
VIN	A2, B2	I	Switch input. Place a decoupling capacitor from VIN to GND. See Application Information section for details about input capacitors.
VOUT	A1, B1	O	Switch output

6 Specifications

6.1 Absolute Maximum Ratings ⁽¹⁾

		MIN	MAX	UNIT
V_{IN}	Input voltage	-0.3	4	V
V_{OUT}	Output voltage		$V_{IN} + 0.3$	V
V_{ON}	ON pin voltage	-0.3	4	V
I_{MAX}	Maximum continuous switch current, $T_A = -40^{\circ}\text{C}$ to 85°C		2	A
I_{PLS}	Maximum pulsed switch current, 100- μs pulse, 2% duty cycle, $T_A = -40^{\circ}\text{C}$ to 85°C		4	A
T_A	Operating free-air temperature	-40	85	$^{\circ}\text{C}$
T_{stg}	Storage temperature	-65	150	$^{\circ}\text{C}$

- (1) Stresses beyond those listed under *Absolute Maximum Ratings* may cause permanent damage to the device. These are stress ratings only, which do not imply functional operation of the device at these or any other conditions beyond those indicated under *Recommended Operating Conditions*. Exposure to absolute-maximum-rated conditions for extended periods may affect device reliability.

6.2 ESD Ratings

		VALUE	UNIT
$V_{(ESD)}$	Electrostatic discharge	Human body model (HBM), per ANSI/ESDA/JEDEC JS-001 ⁽¹⁾	V
		Charged-device model (CDM), per JEDEC specification JESD22-C101 ⁽²⁾	

(1) JEDEC document JEP155 states that 500-V HBM allows safe manufacturing with a standard ESD control process.

(2) JEDEC document JEP157 states that 250-V CDM allows safe manufacturing with a standard ESD control process.

6.3 Recommended Operating Conditions

		MIN	MAX	UNIT
V _{IN}	Input voltage	0.75	3.6	V
V _{OUT}	Output voltage		V _{IN}	V
V _{IH}	High-level input voltage, ON	V _{IN} = 2.5 V to 3.6 V		V
		V _{IN} = 0.75 V to 2.5 V		
V _{IL}	Low-level input voltage, ON	V _{IN} = 2.5 V to 3.6 V		V
		V _{IN} = 0.75 V to 2.49 V		
C _{IN}	Input capacitance	1 ⁽¹⁾		μF

(1) See the *Input Capacitor* section in Application Information.

6.4 Thermal Information

THERMAL METRIC ⁽¹⁾		TPS22924D	UNIT
		YZP (DSBGA)	
		6 PINS	
R _{θJA}	Junction-to-ambient thermal resistance	123	°C/W
R _{θJC(top)}	Junction-to-case (top) thermal resistance	17.6	°C/W
R _{θJB}	Junction-to-board thermal resistance	22.8	°C/W
ψ _{JT}	Junction-to-top characterization parameter	5.7	°C/W
ψ _{JB}	Junction-to-board characterization parameter	22.6	°C/W
R _{θJC(bot)}	Junction-to-case (bottom) thermal resistance	N/A	°C/W

(1) For more information about traditional and new thermal metrics, see the *Semiconductor and IC Package Thermal Metrics* application report, [SPRA953](#).

6.5 Electrical Characteristics

V_{IN} = 0.75 V to 3.6 V (unless otherwise noted)

PARAMETER	TEST CONDITIONS	T _A	MIN	TYP ⁽¹⁾	MAX	UNIT	
I _{Q, VIN}	Quiescent current V _{OUT} = open, V _{IN} = V _{ON}	Full	V _{IN} = 3.6 V		75	160	μA
			V _{IN} = 2.5 V		42	100	
			V _{IN} = 1.8 V		50	350	
			V _{IN} = 1.2 V		95	200	
			V _{IN} = 1.0 V		65	120	
			V _{IN} = 0.75 V		35	80	
I _{SD, VIN}	Shutdown current V _{ON} = GND, V _{OUT} = 0V	Full			4.0	μA	
R _{ON}	ON-state resistance I _{OUT} = -200 mA	25°C	V _{IN} = 3.6 V		18.3	22.8	mΩ
			Full		26.8		
		25°C	V _{IN} = 2.5 V		18.5	23.0	
			Full		27.2		
		25°C	V _{IN} = 1.8 V		19.6	24.1	
			Full		28.1		
		25°C	V _{IN} = 1.2 V		19.4	23.9	
			Full		28.0		
		25°C	V _{IN} = 1.0 V		20.3	24.8	
			Full		29.0		
		25°C	V _{IN} = 0.75 V		22.7	27.2	
			Full		34.8		
R _{PD}	Output pulldown resistance ⁽²⁾ V _{IN} = 3.3 V, V _{ON} = 0, I _{OUT} = 1 mA	25°C	450		1400	Ω	

(1) Typical values are at V_{IN} = 3.3 V and T_A = 25°C.

(2) See *Output Pulldown*.

Electrical Characteristics (continued)

 $V_{IN} = 0.75\text{ V to }3.6\text{ V}$ (unless otherwise noted)

PARAMETER		TEST CONDITIONS	T_A	MIN	TYP ⁽¹⁾	MAX	UNIT
I_{ON}	ON-pin input leakage current	$V_{ON} = 0.9\text{ V to }3.6\text{ V or GND}$	Full			0.1	μA

6.6 Switching Characteristics: $V_{IN} = 3.6\text{ V}$

 $V_{IN} = 3.6\text{ V}$, $T_A = 25^\circ\text{C}$ (unless otherwise noted)

PARAMETER		TEST CONDITIONS	MIN	TYP	MAX	UNIT
t_{ON}	Turn-ON time	$R_L = 10\ \Omega$, $C_L = 0.1\ \mu\text{F}$, $V_{IN} = 3.6\text{V}$		7400		μs
t_{OFF}	Turn-OFF time	$R_L = 10\ \Omega$, $C_L = 0.1\ \mu\text{F}$, $V_{IN} = 3.6\text{V}$		2.5		μs
t_r	V_{OUT} rise time	$R_L = 10\ \Omega$, $C_L = 0.1\ \mu\text{F}$, $V_{IN} = 3.6\text{V}$		6200		μs
t_f	V_{OUT} fall time	$R_L = 10\ \Omega$, $C_L = 0.1\ \mu\text{F}$, $V_{IN} = 3.6\text{V}$		2		μs

6.7 Switching Characteristics: $V_{IN} = 0.9\text{ V}$

 $V_{IN} = 0.9\text{ V}$, $T_A = 25^\circ\text{C}$ (unless otherwise noted)

PARAMETER		TEST CONDITIONS	MIN	TYP	MAX	UNIT
t_{ON}	Turn-ON time	$R_L = 10\ \Omega$, $C_L = 0.1\ \mu\text{F}$, $V_{IN} = 0.9\text{V}$		6300		μs
t_{OFF}	Turn-OFF time	$R_L = 10\ \Omega$, $C_L = 0.1\ \mu\text{F}$, $V_{IN} = 0.9\text{V}$		12		μs
t_r	V_{OUT} rise time	$R_L = 10\ \Omega$, $C_L = 0.1\ \mu\text{F}$, $V_{IN} = 0.9\text{V}$		3200		μs
t_f	V_{OUT} fall time	$R_L = 10\ \Omega$, $C_L = 0.1\ \mu\text{F}$, $V_{IN} = 0.9\text{V}$		3		μs

6.8 Dissipation Ratings

BOARD	DERATING FACTOR ABOVE $T_A = 25^\circ\text{C}$	$T_A < 25^\circ\text{C}$	$T_A = 70^\circ\text{C}$	$T_A = 85^\circ\text{C}$
High-K ⁽¹⁾	- 8.1063 mW/°C	810.63 mW	445.84 mW	324.25 mW

(1) The JEDEC high-K (2s2p) board used to derive this data was a 3- x 3-inch, multilayer board with 1-ounce internal power and ground planes and 2-ounce copper traces on top and bottom of the board.

6.9 Typical Characteristics

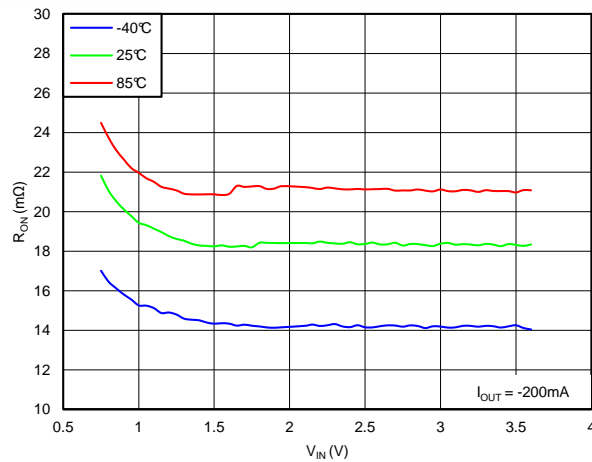

Figure 1. On-State Resistance vs Input Voltage

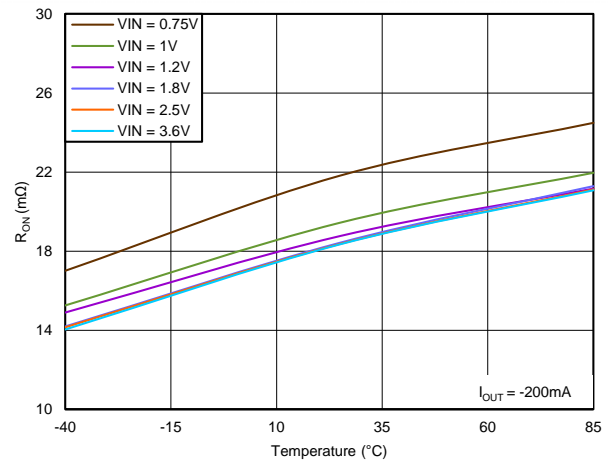

Figure 2. On-State Resistance vs Temperature

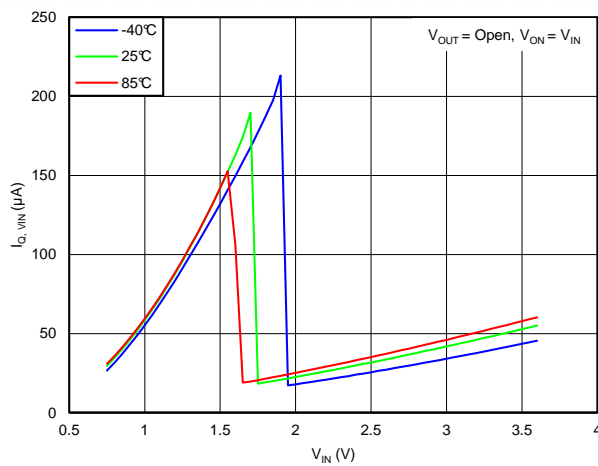

Figure 3. Quiescent Current vs Input Voltage

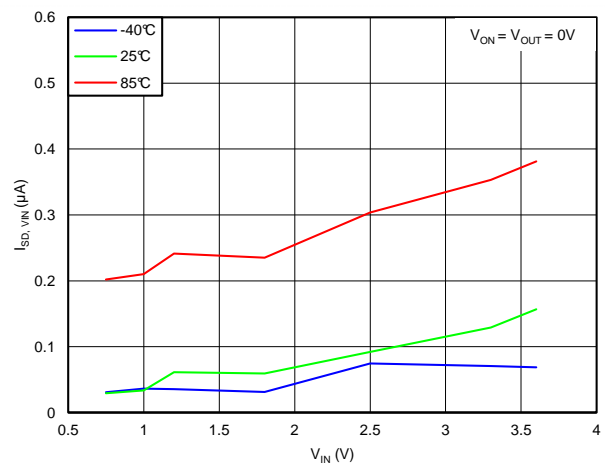

Figure 4. Shutdown Current vs Input Voltage

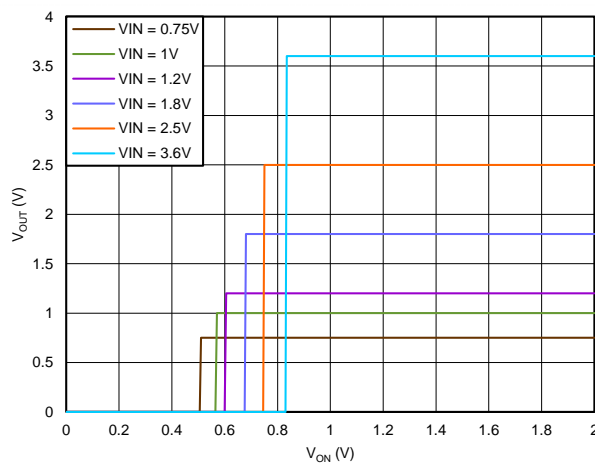

Figure 5. On Input Threshold

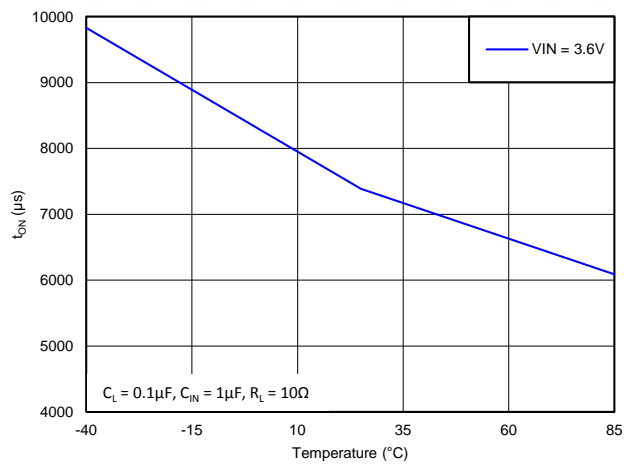

Figure 6. Turnon Time vs Temperature
($V_{IN} = 3.6\text{ V}$, $C_L = 0.1\text{ }\mu\text{F}$, $R_L = 10\text{ }\Omega$)

Typical Characteristics (continued)

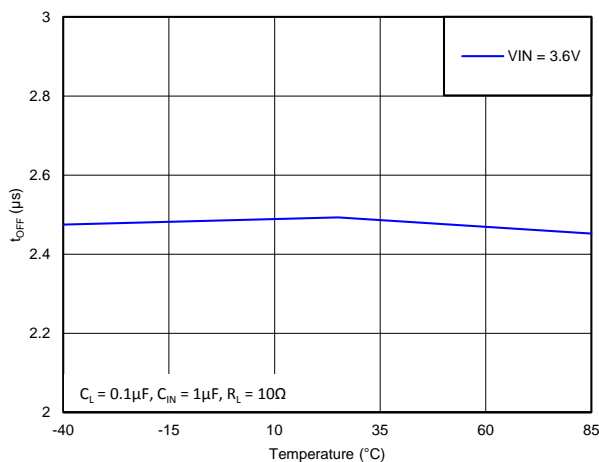

Figure 7. Turnoff Time vs Temperature (V_{IN} = 3.6 V, C_L = 0.1 μF, R_L = 10 Ω)

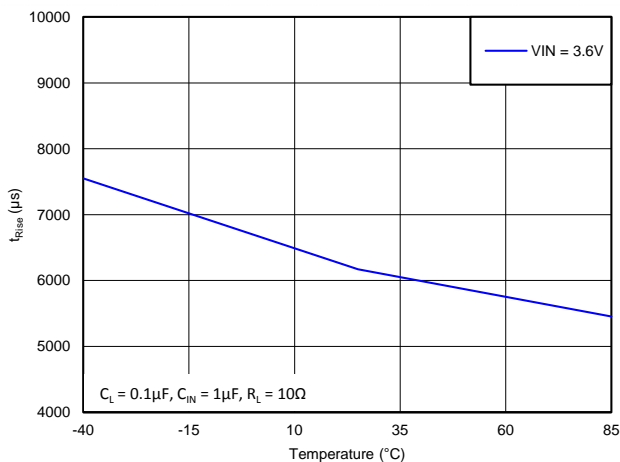

Figure 8. Rise Time vs Temperature (V_{IN} = 3.6 V, C_L = 0.1 μF, R_L = 10 Ω)

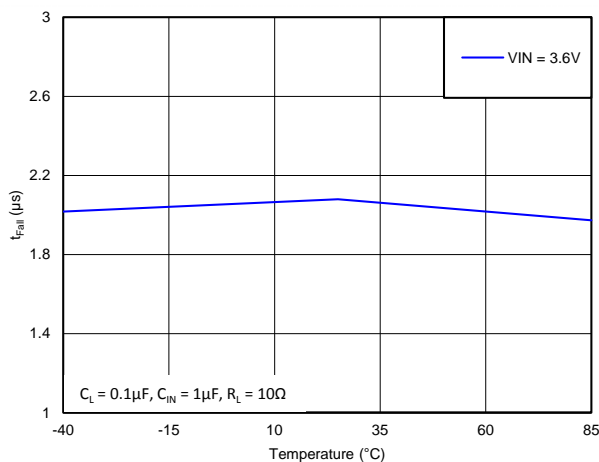

Figure 9. Fall Time vs Temperature (V_{IN} = 3.6 V, C_L = 0.1 μF, R_L = 10 Ω)

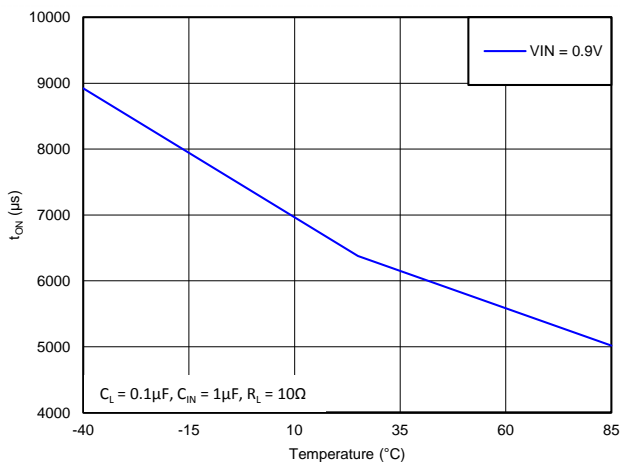

Figure 10. Turnon Time vs Temperature (V_{IN} = 0.9 V, C_L = 0.1 μF, R_L = 10 Ω)

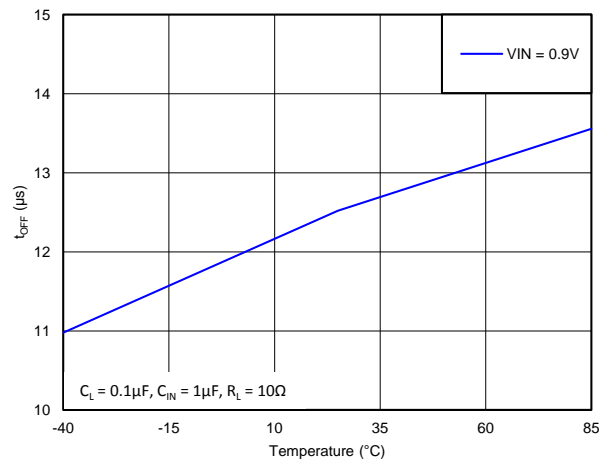

Figure 11. Turnoff Time vs Temperature (V_{IN} = 0.9 V, C_L = 0.1 μF, R_L = 10 Ω)

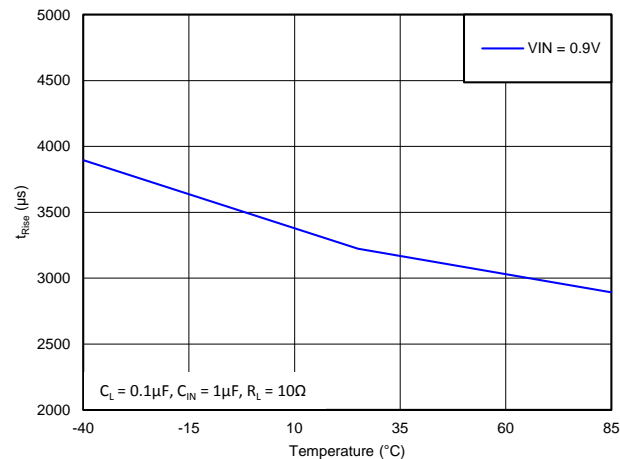

Figure 12. Rise Time vs Temperature (V_{IN} = 0.9 V, C_L = 0.1 μF, R_L = 10 Ω)

Typical Characteristics (continued)

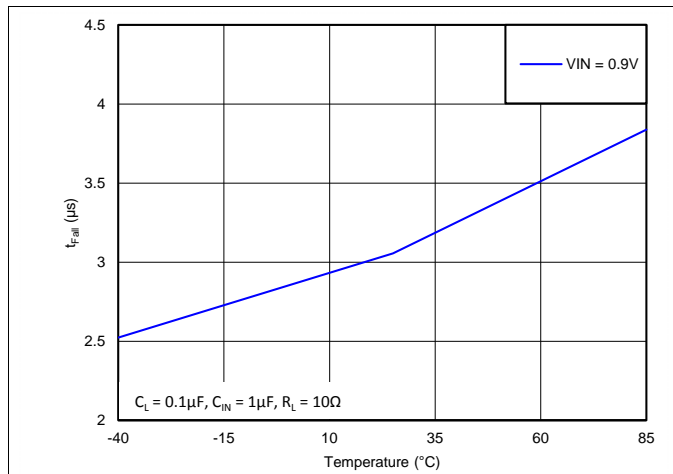

Figure 13. Fall Time vs Temperature
(VIN = 0.9 V, CL = 0.1 µF, RL = 10 Ω)

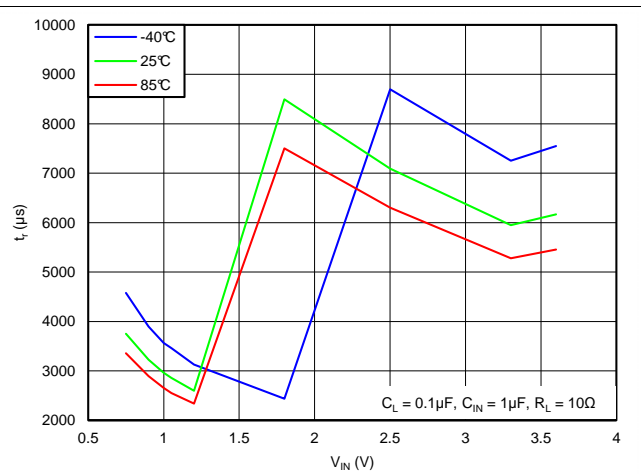

Figure 14. Rise Time vs Input Voltage
(CL = 0.1 µF, RL = 10 Ω, VON = 1.8 V)

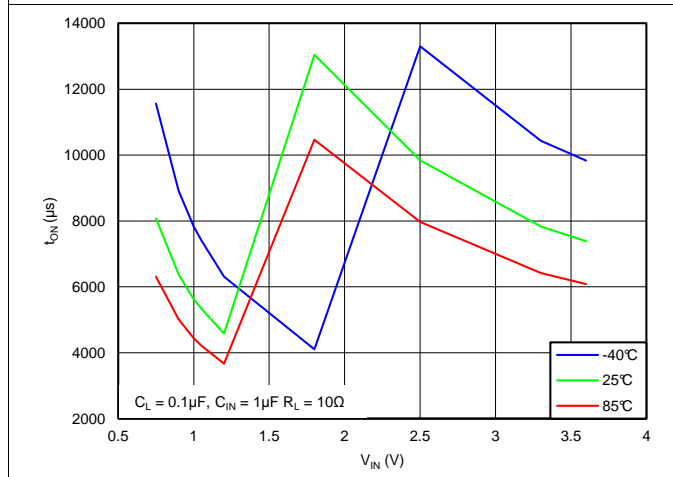

Figure 15. Turnon Time vs Input Voltage
(CL = 0.1 µF, RL = 10 Ω, VON = 1.8 V)

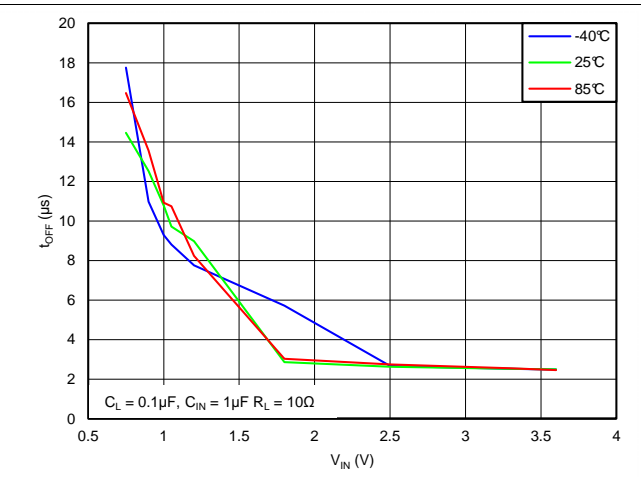

Figure 16. Turnoff Time vs Input Voltage
(CL = 0.1 µF, RL = 10 Ω, VON = 1.8 V)

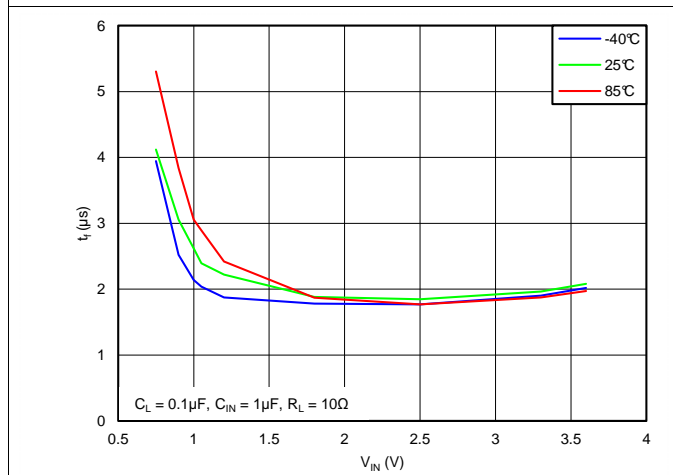

Figure 17. Fall Time vs Input Voltage
(CL = 0.1 µF, RL = 10 Ω, VON = 1.8 V)

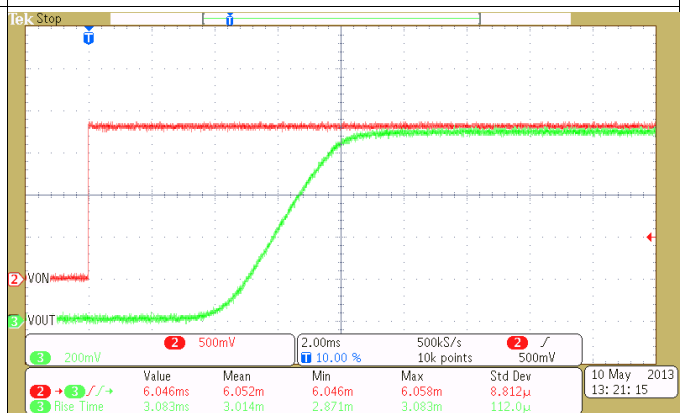

Figure 18. Turnon Response
(CIN = 1 µF, CL = 0.1 µF, RL = 10 Ω, VIN = 0.9 V, TA = 25°C)

Typical Characteristics (continued)

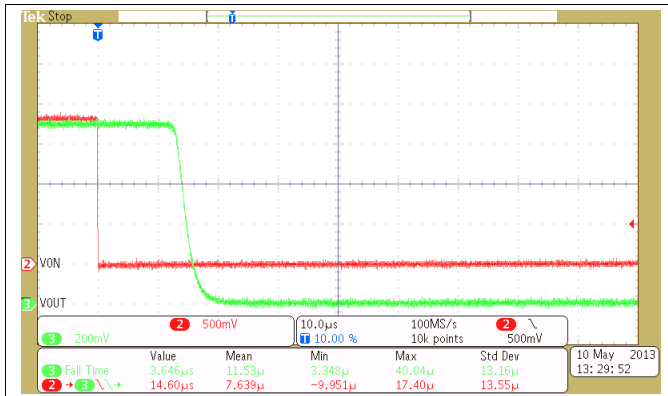

Figure 19. Turnoff Response
($C_{IN} = 1 \mu F, C_L = 0.1 \mu F, R_L = 10 \Omega, V_{IN} = 0.9 V, T_A = 25^\circ C$)

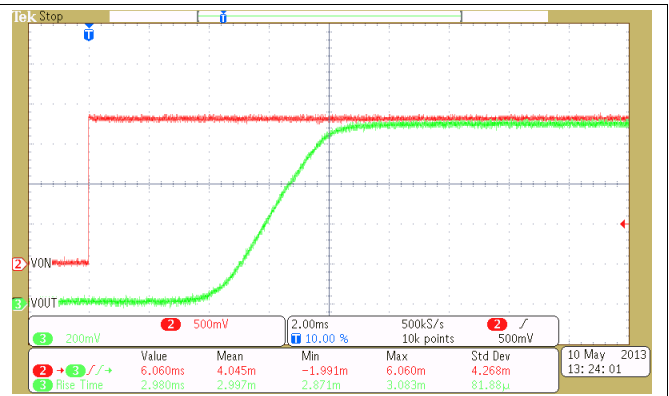

Figure 20. Turnon Response
($C_{IN} = 10 \mu F, C_L = 1 \mu F, R_L = 10 \Omega, V_{IN} = 0.9 V, T_A = 25^\circ C$)

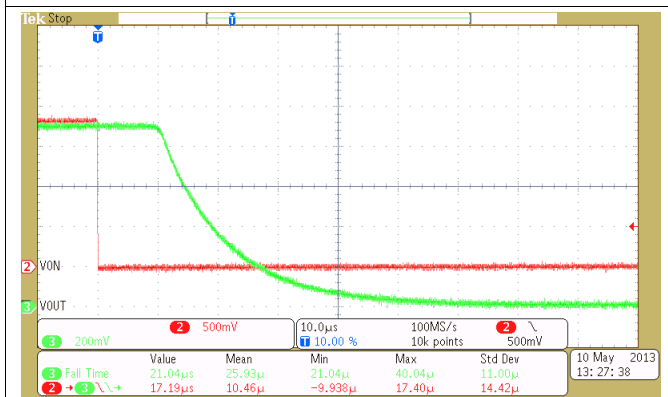

Figure 21. Turnoff Response
($C_{IN} = 10 \mu F, C_L = 1 \mu F, R_L = 10 \Omega, V_{IN} = 0.9 V, T_A = 25^\circ C$)

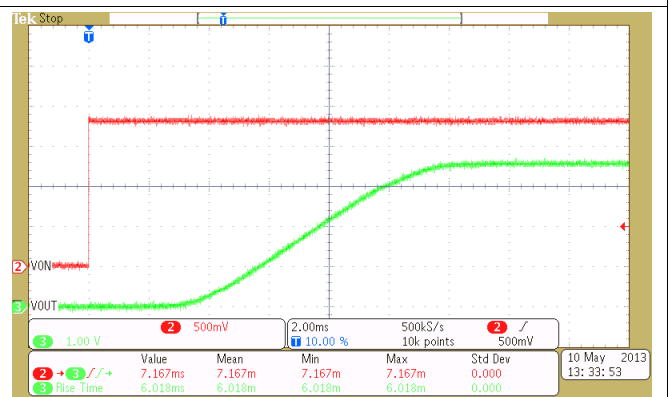

Figure 22. Turnon Response
($C_{IN} = 1 \mu F, C_L = 0.1 \mu F, R_L = 10 \Omega, V_{IN} = 3.6 V, T_A = 25^\circ C$)

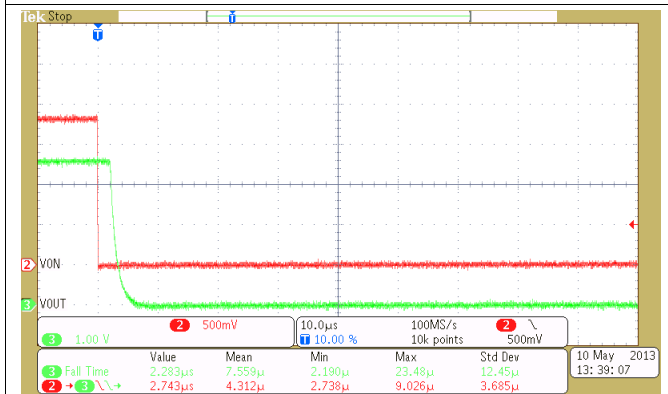

Figure 23. Turnoff Response
($C_{IN} = 1 \mu F, C_L = 0.1 \mu F, R_L = 10 \Omega, V_{IN} = 3.6 V, T_A = 25^\circ C$)

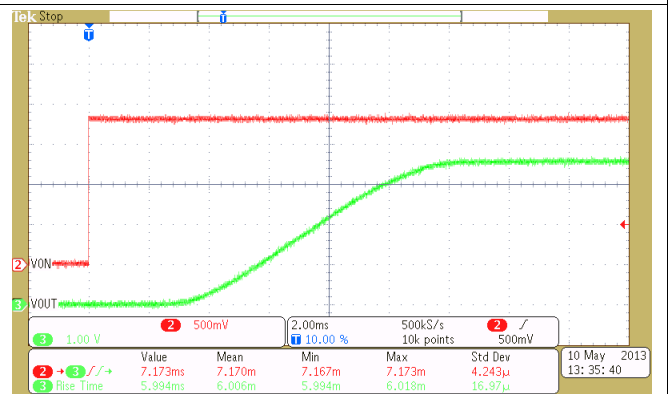
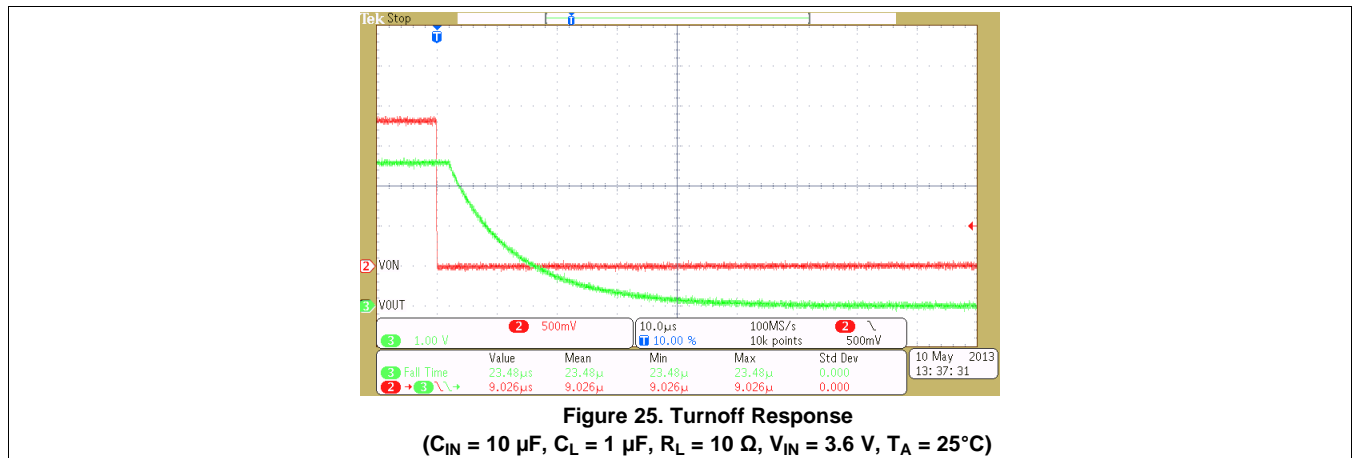
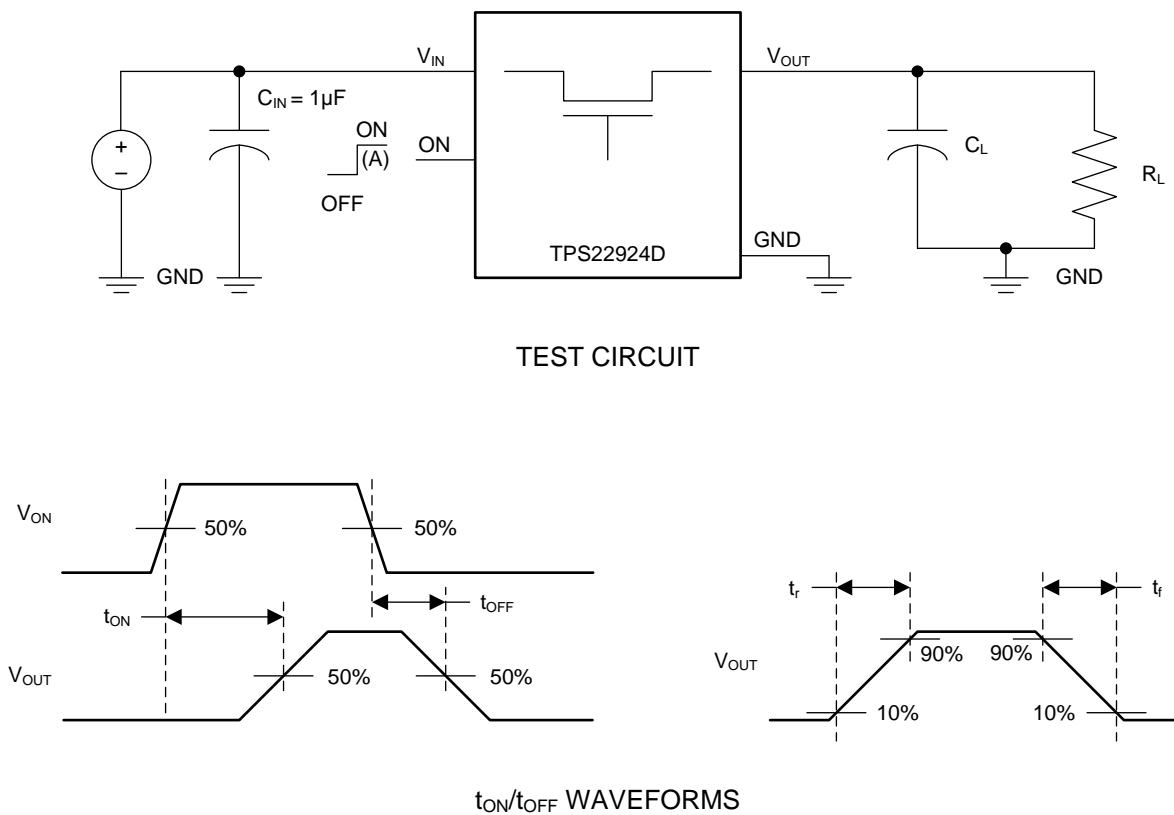

Figure 24. Turnon Response
($C_{IN} = 10 \mu F, C_L = 1 \mu F, R_L = 10 \Omega, V_{IN} = 3.6 V, T_A = 25^\circ C$)

Typical Characteristics (continued)



7 Parametric Measurement Information



A. Rise and fall times of the control signal is 100ns

Figure 26. Test Circuit and t_{ON}/t_{OFF} Waveforms

8 Detailed Description

8.1 Overview

The TPS22924D is a single channel, 2-A load switch in a small, space-saving CSP-6 package. This device implements a low resistance N-channel MOSFET with a controlled rise time for applications that need to limit the inrush current.

This device is also designed to have very low leakage current during off state. This prevents downstream circuits from pulling high standby current from the supply. Integrated control logic, driver, power supply, and output discharge FET eliminates the need for additional external components, which reduces solution size and bill of materials (BOM) count.

8.2 Functional Block Diagram

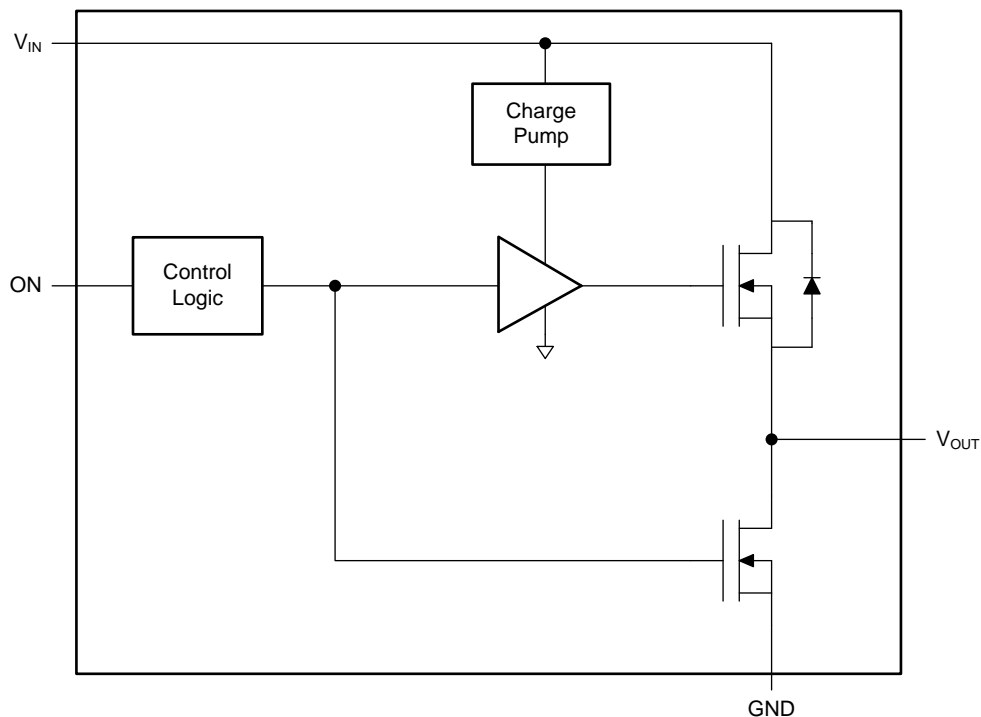

8.3 Feature Description

Table 1 lists the features of the TPS22924D device.

Table 1. Feature List

DEVICE	r_{ON} (TYP) AT 3.6 V	SLEW RATE (TYP) AT 3.6 V	QUICK OUTPUT DISCHARGE ⁽¹⁾	MAXIMUM OUTPUT CURRENT	ENABLE
TPS22924D	18.3 mΩ	6200 μs	Yes	2 A	Active high

(1) This feature discharges the output of the switch to ground through a 1250-Ω resistor, preventing the output from floating. See the *Output Pulldown* section in Application Information.

8.3.1 ON/OFF Control

The ON pin controls the state of the switch. Asserting ON high enables the switch. ON is active high and has a low threshold, making it capable of interfacing with low-voltage signals. The ON pin is compatible with standard GPIO logic threshold. It can be used with any microcontroller with 1.2-V, 1.8-V, 2.5-V or 3.3-V GPIOs.

8.3.2 Output Pulldown

The output pulldown is active when the user is turning off the main pass FET. The pulldown discharges the output rail to approximately 10% of the rail, then the output pulldown is automatically disconnected to optimize the shutdown current.

8.4 Device Functional Modes

[Table 2](#) lists the functional modes of the TPS22924D device.

Table 2. Function Table

ON (Control Signal)	VIN to VOUT	VOUT to GND ⁽¹⁾
L	OFF	ON
H	ON	OFF

(1) See [Output Pulldown](#).

9 Application and Implementation

NOTE

Information in the following applications sections is not part of the TI component specification, and TI does not warrant its accuracy or completeness. TI's customers are responsible for determining suitability of components for their purposes. Customers should validate and test their design implementation to confirm system functionality.

9.1 Application Information

9.1.1 VIN to VOUT Voltage Drop

The VIN to VOUT voltage drop in the device is determined by the R_{ON} of the device and the load current. The R_{ON} of the device depends upon the VIN condition of the device. Refer to the R_{ON} specification of the device in the Electrical Characteristics table of this datasheet. Once the R_{ON} of the device is determined based upon the VIN conditions, use Equation 1 to calculate the VIN to VOUT voltage drop:

$$\Delta V = I_{LOAD} \times R_{ON}$$

where

- ΔV = Voltage drop from VIN to VOUT
- I_{LOAD} = Load current
- R_{ON} = On-resistance of the device for a specific V_{IN}
- An appropriate I_{LOAD} must be chosen such that the I_{MAX} specification of the device is not violated. (1)

9.1.2 Input Capacitor

To limit the voltage drop on the input supply caused by transient inrush currents when the switch turns on into a discharged load capacitor or short-circuit, a capacitor needs to be placed between V_{IN} and GND. A 1- μ F ceramic capacitor, C_{IN} , placed close to the pins is usually sufficient. Higher values of C_{IN} can be used to further reduce the voltage drop.

9.1.3 Output Capacitor

Due to the integrated body diode in the NMOS switch, a C_{IN} greater than C_L is highly recommended. A C_L greater than C_{IN} can cause V_{OUT} to exceed V_{IN} when the system supply is removed. This could result in current flow through the body diode from V_{OUT} to V_{IN} . A C_{IN} to C_L ratio of 10 to 1 is recommended for minimizing V_{IN} dip caused by inrush currents during startup.

9.2 Typical Application

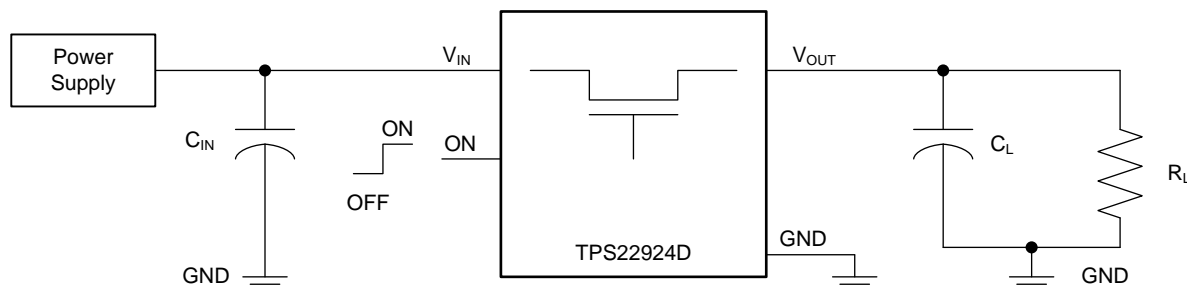

Figure 27. TPS22924D Typical Application

Typical Application (continued)

9.2.1 Design Requirements

Table 3 shows the design requirements for this application.

Table 3. Design Parameters

DESIGN PARAMETER	EXAMPLE VALUE
V _{IN}	3.6 V
C _L	100 μF
Maximum Acceptable Inrush Current	100 mA

9.2.2 Detailed Design Procedure

9.2.2.1 Managing Inrush Current

When the switch is enabled, the output capacitors must be charged up from 0 V to V_{IN}. This charge arrives in the form of inrush current. Inrush current can be calculated using the following equation:

$$\text{Inrush Current} = C \times \frac{dv}{dt}$$

where

- C = Output capacitance
- dv = Output voltage
- dt = Rise time

(2)

The TPS22924D offers a very slow controlled rise time for minimizing inrush current. This device can be selected based upon the maximum acceptable slew rate which can be calculated using the design requirements and the inrush current equation. An output capacitance of 100 μF will be used since the amount of inrush increases with output capacitance:

$$100\text{mA} = 100\mu\text{F} \times (3.6\text{V} / dt)$$

(3)

$$dt = 3600\mu\text{s}$$

(4)

To ensure an inrush current of less than 100 mA, a device with a rise time greater than 3600 μs must be used.

The TPS22924D has a typical rise time of 6200 μs at 3.6 V. This meets the above design requirements.

9.2.3 Application Curve

Figure 28 shows the TPS22924D turning on into a 100 μF load.

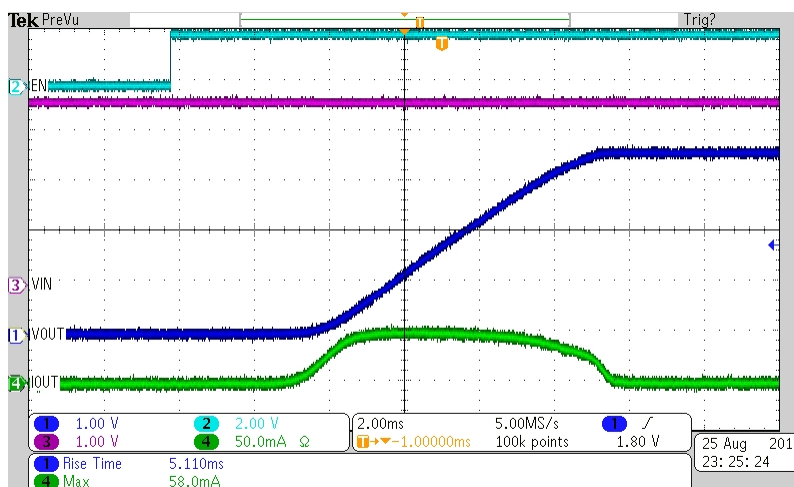

Figure 28. TPS22924D Inrush Current With a 100μF Load

10 Power Supply Recommendations

The device is designed to operate with a V_{IN} range of 0.75 V to 3.6 V. This supply must be well regulated and placed as close to the device terminal as possible with the recommended 1 μF bypass capacitor. If the supply is located more than a few inches from the device terminals, additional bulk capacitance may be required in addition to the ceramic bypass capacitors. If additional bulk capacitance is required, an electrolytic, tantalum, or ceramic capacitor of 10 μF may be sufficient.

11 Layout

11.1 Layout Guidelines

For best performance, all traces should be as short as possible. To be most effective, the input and output capacitors should be placed close to the device to minimize the effects that parasitic trace inductances may have on normal and short-circuit operation. Using wide traces for V_{IN} , V_{OUT} , and GND helps minimize the parasitic electrical effects along with minimizing the case to ambient thermal impedance.

11.2 Layout Example

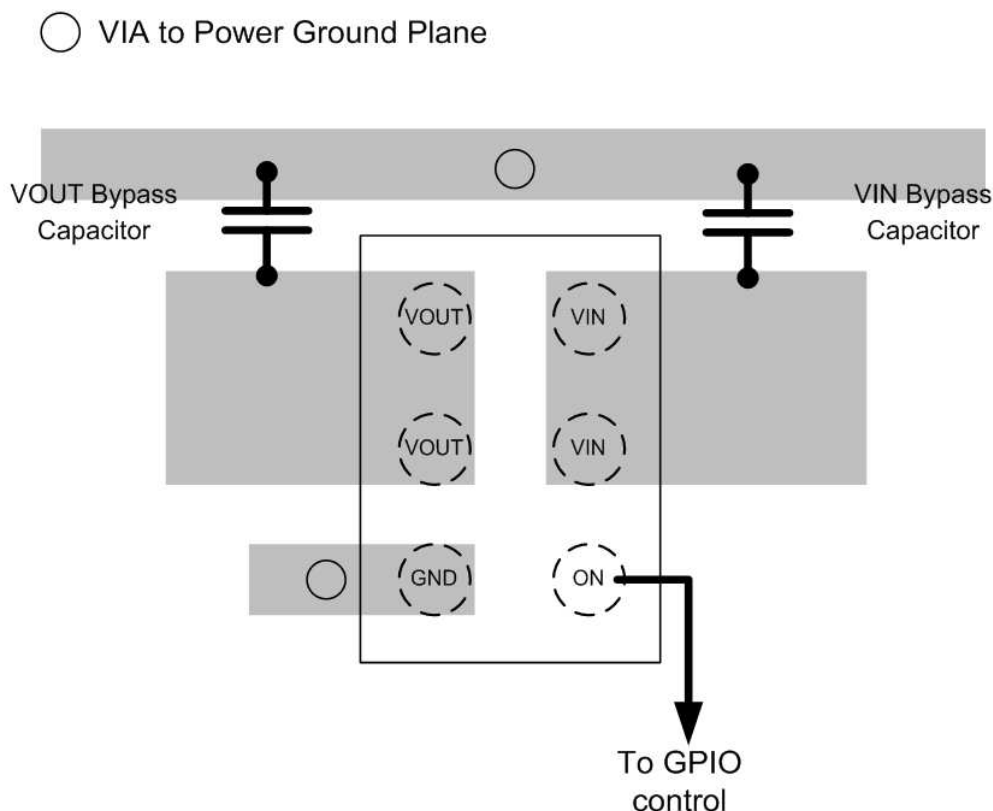

Figure 29. TPS22924D Layout Example

12 Device and Documentation Support

12.1 Community Resources

The following links connect to TI community resources. Linked contents are provided "AS IS" by the respective contributors. They do not constitute TI specifications and do not necessarily reflect TI's views; see TI's [Terms of Use](#).

TI E2E™ Online Community *TI's Engineer-to-Engineer (E2E) Community*. Created to foster collaboration among engineers. At e2e.ti.com, you can ask questions, share knowledge, explore ideas and help solve problems with fellow engineers.

Design Support *TI's Design Support* Quickly find helpful E2E forums along with design support tools and contact information for technical support.

12.2 Trademarks

E2E is a trademark of Texas Instruments.
All other trademarks are the property of their respective owners.

12.3 Electrostatic Discharge Caution



These devices have limited built-in ESD protection. The leads should be shorted together or the device placed in conductive foam during storage or handling to prevent electrostatic damage to the MOS gates.

12.4 Glossary

[SLYZ022](#) — *TI Glossary*.

This glossary lists and explains terms, acronyms, and definitions.

13 Mechanical, Packaging, and Orderable Information

The following pages include mechanical, packaging, and orderable information. This information is the most current data available for the designated devices. This data is subject to change without notice and revision of this document. For browser-based versions of this data sheet, refer to the left-hand navigation.

PACKAGING INFORMATION

Orderable Device	Status (1)	Package Type	Package Drawing	Pins	Package Qty	Eco Plan (2)	Lead/Ball Finish (6)	MSL Peak Temp (3)	Op Temp (°C)	Device Marking (4/5)	Samples
TPS22924DYZPR	ACTIVE	DSBGA	YZP	6	3000	Green (RoHS & no Sb/Br)	SNAGCU	Level-1-260C-UNLIM	-40 to 85	DL	Samples
TPS22924DYZPT	ACTIVE	DSBGA	YZP	6	250	Green (RoHS & no Sb/Br)	SNAGCU	Level-1-260C-UNLIM	-40 to 85	DL	Samples

(1) The marketing status values are defined as follows:

ACTIVE: Product device recommended for new designs.

LIFEBUY: TI has announced that the device will be discontinued, and a lifetime-buy period is in effect.

NRND: Not recommended for new designs. Device is in production to support existing customers, but TI does not recommend using this part in a new design.

PREVIEW: Device has been announced but is not in production. Samples may or may not be available.

OBsolete: TI has discontinued the production of the device.

(2) Eco Plan - The planned eco-friendly classification: Pb-Free (RoHS), Pb-Free (RoHS Exempt), or Green (RoHS & no Sb/Br) - please check <http://www.ti.com/productcontent> for the latest availability information and additional product content details.

TBD: The Pb-Free/Green conversion plan has not been defined.

Pb-Free (RoHS): TI's terms "Lead-Free" or "Pb-Free" mean semiconductor products that are compatible with the current RoHS requirements for all 6 substances, including the requirement that lead not exceed 0.1% by weight in homogeneous materials. Where designed to be soldered at high temperatures, TI Pb-Free products are suitable for use in specified lead-free processes.

Pb-Free (RoHS Exempt): This component has a RoHS exemption for either 1) lead-based flip-chip solder bumps used between the die and package, or 2) lead-based die adhesive used between the die and leadframe. The component is otherwise considered Pb-Free (RoHS compatible) as defined above.

Green (RoHS & no Sb/Br): TI defines "Green" to mean Pb-Free (RoHS compatible), and free of Bromine (Br) and Antimony (Sb) based flame retardants (Br or Sb do not exceed 0.1% by weight in homogeneous material)

(3) MSL, Peak Temp. - The Moisture Sensitivity Level rating according to the JEDEC industry standard classifications, and peak solder temperature.

(4) There may be additional marking, which relates to the logo, the lot trace code information, or the environmental category on the device.

(5) Multiple Device Markings will be inside parentheses. Only one Device Marking contained in parentheses and separated by a "~" will appear on a device. If a line is indented then it is a continuation of the previous line and the two combined represent the entire Device Marking for that device.

(6) Lead/Ball Finish - Orderable Devices may have multiple material finish options. Finish options are separated by a vertical ruled line. Lead/Ball Finish values may wrap to two lines if the finish value exceeds the maximum column width.

Important Information and Disclaimer: The information provided on this page represents TI's knowledge and belief as of the date that it is provided. TI bases its knowledge and belief on information provided by third parties, and makes no representation or warranty as to the accuracy of such information. Efforts are underway to better integrate information from third parties. TI has taken and continues to take reasonable steps to provide representative and accurate information but may not have conducted destructive testing or chemical analysis on incoming materials and chemicals. TI and TI suppliers consider certain information to be proprietary, and thus CAS numbers and other limited information may not be available for release.

In no event shall TI's liability arising out of such information exceed the total purchase price of the TI part(s) at issue in this document sold by TI to Customer on an annual basis.

TAPE AND REEL INFORMATION



QUADRANT ASSIGNMENTS FOR PIN 1 ORIENTATION IN TAPE



*All dimensions are nominal

Device	Package Type	Package Drawing	Pins	SPQ	Reel Diameter (mm)	Reel Width W1 (mm)	A0 (mm)	B0 (mm)	K0 (mm)	P1 (mm)	W (mm)	Pin1 Quadrant
TPS22924DYZPR	DSBGA	YZP	6	3000	178.0	9.2	1.02	1.52	0.63	4.0	8.0	Q1
TPS22924DYZPT	DSBGA	YZP	6	250	178.0	9.2	1.02	1.52	0.63	4.0	8.0	Q1

TAPE AND REEL BOX DIMENSIONS

*All dimensions are nominal

Device	Package Type	Package Drawing	Pins	SPQ	Length (mm)	Width (mm)	Height (mm)
TPS22924DYZPR	DSBGA	YZP	6	3000	220.0	220.0	35.0
TPS22924DYZPT	DSBGA	YZP	6	250	220.0	220.0	35.0

EXAMPLE BOARD LAYOUT

YZP0006

DSBGA - 0.5 mm max height

DIE SIZE BALL GRID ARRAY



LAND PATTERN EXAMPLE
SCALE:40X

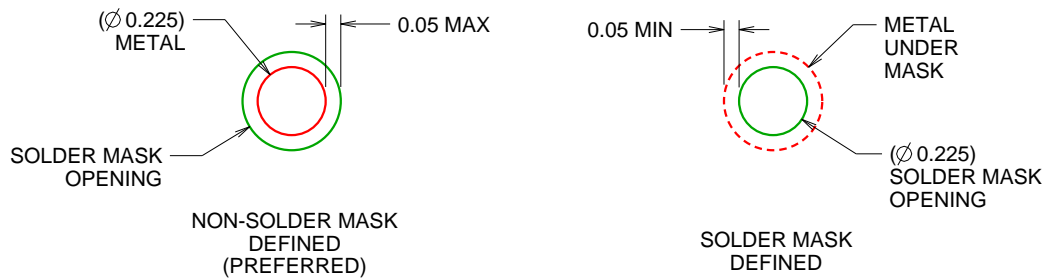

SOLDER MASK DETAILS
NOT TO SCALE

4219524/A 06/2014

NOTES: (continued)

- Final dimensions may vary due to manufacturing tolerance considerations and also routing constraints. For more information, see Texas Instruments literature number SBVA017 (www.ti.com/lit/sbva017).

EXAMPLE STENCIL DESIGN

YZP0006

DSBGA - 0.5 mm max height

DIE SIZE BALL GRID ARRAY

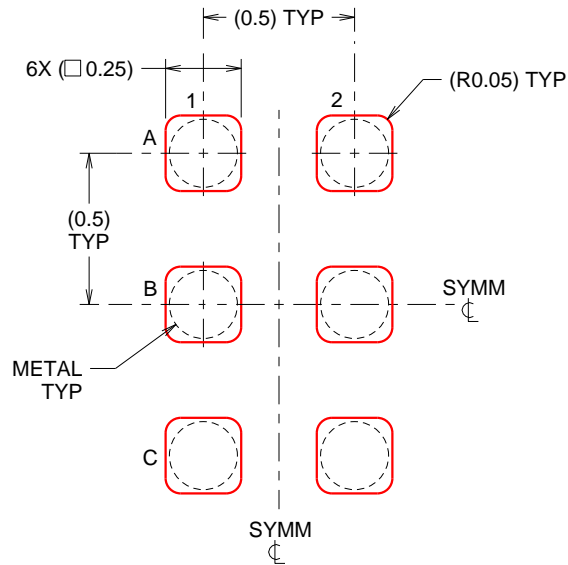

SOLDER PASTE EXAMPLE
BASED ON 0.1 mm THICK STENCIL
SCALE:40X

4219524/A 06/2014

NOTES: (continued)

5. Laser cutting apertures with trapezoidal walls and rounded corners may offer better paste release.

IMPORTANT NOTICE

Texas Instruments Incorporated (TI) reserves the right to make corrections, enhancements, improvements and other changes to its semiconductor products and services per JESD46, latest issue, and to discontinue any product or service per JESD48, latest issue. Buyers should obtain the latest relevant information before placing orders and should verify that such information is current and complete.

TI's published terms of sale for semiconductor products (<http://www.ti.com/sc/docs/stdterms.htm>) apply to the sale of packaged integrated circuit products that TI has qualified and released to market. Additional terms may apply to the use or sale of other types of TI products and services.

Reproduction of significant portions of TI information in TI data sheets is permissible only if reproduction is without alteration and is accompanied by all associated warranties, conditions, limitations, and notices. TI is not responsible or liable for such reproduced documentation. Information of third parties may be subject to additional restrictions. Resale of TI products or services with statements different from or beyond the parameters stated by TI for that product or service voids all express and any implied warranties for the associated TI product or service and is an unfair and deceptive business practice. TI is not responsible or liable for any such statements.

Buyers and others who are developing systems that incorporate TI products (collectively, "Designers") understand and agree that Designers remain responsible for using their independent analysis, evaluation and judgment in designing their applications and that Designers have full and exclusive responsibility to assure the safety of Designers' applications and compliance of their applications (and of all TI products used in or for Designers' applications) with all applicable regulations, laws and other applicable requirements. Designer represents that, with respect to their applications, Designer has all the necessary expertise to create and implement safeguards that (1) anticipate dangerous consequences of failures, (2) monitor failures and their consequences, and (3) lessen the likelihood of failures that might cause harm and take appropriate actions. Designer agrees that prior to using or distributing any applications that include TI products, Designer will thoroughly test such applications and the functionality of such TI products as used in such applications.

TI's provision of technical, application or other design advice, quality characterization, reliability data or other services or information, including, but not limited to, reference designs and materials relating to evaluation modules, (collectively, "TI Resources") are intended to assist designers who are developing applications that incorporate TI products; by downloading, accessing or using TI Resources in any way, Designer (individually or, if Designer is acting on behalf of a company, Designer's company) agrees to use any particular TI Resource solely for this purpose and subject to the terms of this Notice.

TI's provision of TI Resources does not expand or otherwise alter TI's applicable published warranties or warranty disclaimers for TI products, and no additional obligations or liabilities arise from TI providing such TI Resources. TI reserves the right to make corrections, enhancements, improvements and other changes to its TI Resources. TI has not conducted any testing other than that specifically described in the published documentation for a particular TI Resource.

Designer is authorized to use, copy and modify any individual TI Resource only in connection with the development of applications that include the TI product(s) identified in such TI Resource. NO OTHER LICENSE, EXPRESS OR IMPLIED, BY ESTOPPEL OR OTHERWISE TO ANY OTHER TI INTELLECTUAL PROPERTY RIGHT, AND NO LICENSE TO ANY TECHNOLOGY OR INTELLECTUAL PROPERTY RIGHT OF TI OR ANY THIRD PARTY IS GRANTED HEREIN, including but not limited to any patent right, copyright, mask work right, or other intellectual property right relating to any combination, machine, or process in which TI products or services are used. Information regarding or referencing third-party products or services does not constitute a license to use such products or services, or a warranty or endorsement thereof. Use of TI Resources may require a license from a third party under the patents or other intellectual property of the third party, or a license from TI under the patents or other intellectual property of TI.

TI RESOURCES ARE PROVIDED "AS IS" AND WITH ALL FAULTS. TI DISCLAIMS ALL OTHER WARRANTIES OR REPRESENTATIONS, EXPRESS OR IMPLIED, REGARDING RESOURCES OR USE THEREOF, INCLUDING BUT NOT LIMITED TO ACCURACY OR COMPLETENESS, TITLE, ANY EPIDEMIC FAILURE WARRANTY AND ANY IMPLIED WARRANTIES OF MERCHANTABILITY, FITNESS FOR A PARTICULAR PURPOSE, AND NON-INFRINGEMENT OF ANY THIRD PARTY INTELLECTUAL PROPERTY RIGHTS. TI SHALL NOT BE LIABLE FOR AND SHALL NOT DEFEND OR INDEMNIFY DESIGNER AGAINST ANY CLAIM, INCLUDING BUT NOT LIMITED TO ANY INFRINGEMENT CLAIM THAT RELATES TO OR IS BASED ON ANY COMBINATION OF PRODUCTS EVEN IF DESCRIBED IN TI RESOURCES OR OTHERWISE. IN NO EVENT SHALL TI BE LIABLE FOR ANY ACTUAL, DIRECT, SPECIAL, COLLATERAL, INDIRECT, PUNITIVE, INCIDENTAL, CONSEQUENTIAL OR EXEMPLARY DAMAGES IN CONNECTION WITH OR ARISING OUT OF TI RESOURCES OR USE THEREOF, AND REGARDLESS OF WHETHER TI HAS BEEN ADVISED OF THE POSSIBILITY OF SUCH DAMAGES.

Unless TI has explicitly designated an individual product as meeting the requirements of a particular industry standard (e.g., ISO/TS 16949 and ISO 26262), TI is not responsible for any failure to meet such industry standard requirements.

Where TI specifically promotes products as facilitating functional safety or as compliant with industry functional safety standards, such products are intended to help enable customers to design and create their own applications that meet applicable functional safety standards and requirements. Using products in an application does not by itself establish any safety features in the application. Designers must ensure compliance with safety-related requirements and standards applicable to their applications. Designer may not use any TI products in life-critical medical equipment unless authorized officers of the parties have executed a special contract specifically governing such use. Life-critical medical equipment is medical equipment where failure of such equipment would cause serious bodily injury or death (e.g., life support, pacemakers, defibrillators, heart pumps, neurostimulators, and implantables). Such equipment includes, without limitation, all medical devices identified by the U.S. Food and Drug Administration as Class III devices and equivalent classifications outside the U.S.

TI may expressly designate certain products as completing a particular qualification (e.g., Q100, Military Grade, or Enhanced Product). Designers agree that it has the necessary expertise to select the product with the appropriate qualification designation for their applications and that proper product selection is at Designers' own risk. Designers are solely responsible for compliance with all legal and regulatory requirements in connection with such selection.

Designer will fully indemnify TI and its representatives against any damages, costs, losses, and/or liabilities arising out of Designer's non-compliance with the terms and provisions of this Notice.

Looking for pricing, stock, or lifecycle information?

Click below to explore more details on WIN SOURCE:

 [View TPS22924DYZPT on WIN SOURCE](#)

 [Texas Instruments](#) Information

Optimize Your Supply Chain with WIN SOURCE Solutions

-  Global Sourcing Solution
-  Obsolete Management
-  Cost Control Management
-  Shortage Management
-  Alternative Solution
-  Excess Inventory Management