



**THE DATASHEET OF  
SN74HC04DTG4**



## SNx4HC04 Hex Inverters

### 1 Features

- Wide Operating Voltage Range of 2 V to 6 V
- Outputs Can Drive up to 10 LSTTL Loads
- Low Power Consumption, 20- $\mu$ A Maximum  $I_{CC}$
- Typical  $t_{pd} = 8$  ns
- $\pm 4$ -mA Output Drive at 5 V
- Low Input Current of 1  $\mu$ A Maximum

### 2 Applications

- Cameras
- E-Meters
- Ethernet Switches
- Infotainment

### 3 Description

The SNx4HC04 devices contain six independent inverters. They perform the Boolean function  $Y = \bar{A}$  in positive logic.

#### Device Information<sup>(1)</sup>

PART NUMBER	PACKAGE	BODY SIZE (NOM)
SN54HC04	LCCC (20)	8.89 mm x 8.89 mm
	CDIP (14)	19.56 mm x 6.67 mm
	CFP (14)	9.21 mm x 5.97 mm
SN74HC04	SOIC (14)	8.65 mm x 3.91 mm
	PDIP (14)	19.30 mm x 6.35 mm
	SOP (14)	10.3 mm x 5.3 mm
	TSSOP (14)	5.00 mm x 4.40 mm

(1) For all available packages, see the orderable addendum at the end of the data sheet.

#### Logic Diagram (Positive Logic)

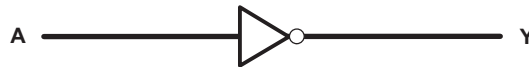

## Table of Contents

<b>1 Features</b> ..... 1 <b>2 Applications</b> ..... 1 <b>3 Description</b> ..... 1 <b>4 Revision History</b> ..... 2 <b>5 Pin Configuration and Functions</b> ..... 3 <b>6 Specifications</b> ..... 4 6.1 Absolute Maximum Ratings ..... 4 6.2 ESD Ratings ..... 4 6.3 Recommended Operating Conditions ..... 4 6.4 Electrical Characteristics ..... 5 6.5 Switching Characteristics ..... 5 6.6 Operating Characteristics ..... 5 6.7 Typical Characteristics ..... 6 <b>7 Parameter Measurement Information</b> ..... 7 <b>8 Detailed Description</b> ..... 8 8.1 Overview ..... 8 8.2 Functional Block Diagram ..... 8	8.3 Feature Description ..... 8 8.4 Device Functional Modes ..... 8 <b>9 Application and Implementation</b> ..... 9 9.1 Application Information ..... 9 9.2 Typical Application ..... 9 <b>10 Power Supply Recommendations</b> ..... 11 <b>11 Layout</b> ..... 11 11.1 Layout Guidelines ..... 11 11.2 Layout Example ..... 11 <b>12 Device and Documentation Support</b> ..... 12 12.1 Related Links ..... 12 12.2 Community Resource ..... 12 12.3 Trademarks ..... 12 12.4 Electrostatic Discharge Caution ..... 12 12.5 Glossary ..... 12 <b>13 Mechanical, Packaging, and Orderable Information</b> ..... 12
---	--

## 4 Revision History

NOTE: Page numbers for previous revisions may differ from page numbers in the current version.

<b>Changes from Revision F (August 2013) to Revision G</b>	<b>Page</b>
• Added <i>ESD Ratings</i> table, <i>Feature Description</i> section, <i>Device Functional Modes</i> , <i>Application and Implementation</i> section, <i>Power Supply Recommendations</i> section, <i>Layout</i> section, <i>Device and Documentation Support</i> section, and <i>Mechanical, Packaging, and Orderable Information</i> section .....	1
• ESD warning added.....	4

<b>Changes from Revision E (October 2010) to Revision F</b>	<b>Page</b>
• Removed Ordering Information table .....	3

## 5 Pin Configuration and Functions

**J, W, D, DB, N, NS, or PW Packages  
14-Pin SOIC, CDIP, CFP, PDIP, TSSOP, SOP  
Top View**

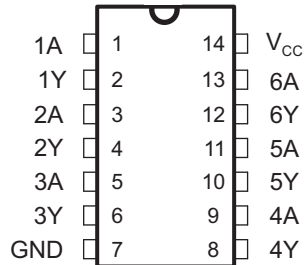

**FK Package  
Top View**

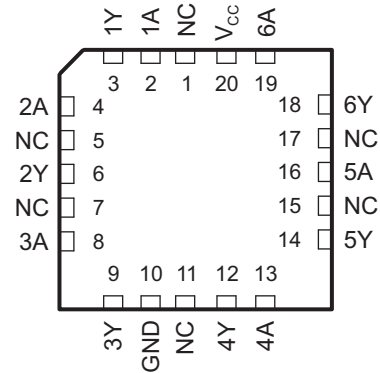

NC – No internal connection

### Pin Functions

NAME	PIN		I/O	DESCRIPTION
	SOIC, CDIP, CFP, SSOP, PDIP, TSSOP	LCCC		
1A	1	2	I	Input 1A
1Y	2	3	O	Output 1Y
2A	3	4	I	Input 2A
2Y	4	6	O	Output 2Y
3A	5	8	I	Input 3A
3Y	6	9	O	Output 3Y
GND	7	10	—	Ground Pin
4Y	8	12	O	Output 4Y
4A	9	13	I	Input 4A
5Y	10	14	O	Output 5Y
5A	11	16	I	Input 6A
6Y	12	18	O	Output 6Y
6A	13	19	I	Input 6A
VCC	14	20	—	Power Pin
NC	—	1,5,7,11,15,17	—	No Connection

## 6 Specifications

### 6.1 Absolute Maximum Ratings

 over operating free-air temperature range (unless otherwise noted)<sup>(1)</sup>

		MIN	MAX	UNIT
$V_{CC}$	Supply voltage	-0.5	7	V
$I_{IK}$	Input clamp current <sup>(2)</sup>	$V_I < 0$ or $V_I > V_{CC}$		mA
$I_{OK}$	Output clamp current <sup>(2)</sup>	$V_O < 0$		mA
$I_O$	Continuous output current	$V_O = 0$ to $V_{CC}$		mA
	Continuous current through $V_{CC}$ or GND			mA
$T_{stg}$	Storage temperature	-60	150	°C

- (1) Stresses beyond those listed under *Absolute Maximum Ratings* may cause permanent damage to the device. These are stress ratings only, which do not imply functional operation of the device at these or any other conditions beyond those indicated under *Recommended Operating Conditions*. Exposure to absolute-maximum-rated conditions for extended periods may affect device reliability.
- (2) The input and output negative-voltage ratings may be exceeded if the input and output clamp-current ratings are observed.

### 6.2 ESD Ratings

		VALUE	UNIT
$V_{(ESD)}$	Electrostatic discharge	Human-body model (HBM), per ANSI/ESDA/JEDEC JS-001 <sup>(1)</sup>	±2000
		Machine Model	±250

- (1) JEDEC document JEP155 states that 500-V HBM allows safe manufacturing with a standard ESD control process.

### 6.3 Recommended Operating Conditions

 over operating free-air temperature range (unless otherwise noted)<sup>(1)</sup>

		SN54HC04			SN74HC04			UNIT
		MIN	NOM	MAX	MIN	NOM	MAX	
$V_{CC}$	Supply voltage	2	5	6	2	5	6	V
$V_{IH}$	High-level input voltage	$V_{CC} = 2$ V		1.5	1.5		V	
		$V_{CC} = 4.5$ V		3.15	3.15			
		$V_{CC} = 6$ V		4.2	4.2			
$V_{IL}$	Low-level input voltage	$V_{CC} = 2$ V			0.5		V	
		$V_{CC} = 4.5$ V			1.35			
		$V_{CC} = 6$ V			1.8			
$V_I$	Input voltage	0		$V_{CC}$	0		$V_{CC}$	V
$V_O$	Output voltage	0		$V_{CC}$	0		$V_{CC}$	V
$\Delta t/\Delta v$	Input transition rise or fall rate	$V_{CC} = 2$ V			1000		ns	
		$V_{CC} = 4.5$ V			500			
		$V_{CC} = 6$ V			400			
$T_A$	Operating free-air temperature	-55		125	-40		85	°C

- (1) All unused inputs of the device must be held at  $V_{CC}$  or GND to ensure proper device operation. Refer to the TI application report, *Implications of Slow or Floating CMOS Inputs*, literature number [SCBA004](#).

## 6.4 Electrical Characteristics

over operating free-air temperature range (unless otherwise noted)

PARAMETER	TEST CONDITIONS		V <sub>CC</sub>	T <sub>A</sub> = 25°C			SN54HC04		SN74HC04		UNIT	
				MIN	TYP	MAX	MIN	MAX	MIN	MAX		
V <sub>OH</sub>	V <sub>I</sub> = V <sub>IH</sub> or V <sub>IL</sub>	I <sub>OH</sub> = -20 μA	2 V	1.9	1.998		1.9		1.9	V		
			4.5 V	4.4	4.499		4.4		4.4			
			6 V	5.9	5.999		5.9		5.9			
		I <sub>OH</sub> = -4 mA	4.5 V	3.98	4.3		3.7		3.84			
		I <sub>OH</sub> = -5.2 mA	6 V	5.48	5.8		5.2		5.34			
V <sub>OL</sub>	V <sub>I</sub> = V <sub>IH</sub> or V <sub>IL</sub>	I <sub>OL</sub> = 20 μA	2 V		0.002	0.1		0.1		0.1	V	
			4.5 V		0.001	0.1		0.1		0.1		
			6 V		0.001	0.1		0.1		0.1		
		I <sub>OL</sub> = 4 mA	4.5 V		0.17	0.26		0.4		0.33		
		I <sub>OL</sub> = 5.2 mA	6 V		0.15	0.26		0.4		0.33		
I <sub>I</sub>	V <sub>I</sub> = V <sub>CC</sub> or 0		6 V		±0.1	±100		±1000		±1000	nA	
I <sub>CC</sub>	V <sub>I</sub> = V <sub>CC</sub> or 0, I <sub>O</sub> = 0		6 V					2		40	20	μA
C <sub>i</sub>			6 V							3	10	pF

## 6.5 Switching Characteristics

over operating free-air temperature range, C<sub>L</sub> = 50 pF (unless otherwise noted) (see [Figure 3](#))

PARAMETER	FROM (INPUT)	TO (OUTPUT)	V <sub>CC</sub>	T <sub>A</sub> = 25°C			SN54HC04		SN74HC04		UNIT
				MIN	TYP	MAX	MIN	MAX	MIN	MAX	
t <sub>pd</sub>	A	Y	2 V		45	95		125		120	ns
			4.5 V		9	19		29		24	
			6 V		8	16		25		20	
t <sub>t</sub>		Y	2 V		38	75		110		95	ns
			4.5 V		8	15		22		19	
			6 V		6	13		19		16	

## 6.6 Operating Characteristics

T<sub>A</sub> = 25°C

PARAMETER	TEST CONDITIONS	TYP	UNIT
C <sub>pd</sub>	Power dissipation capacitance per inverter No load	20	pF

### 6.7 Typical Characteristics

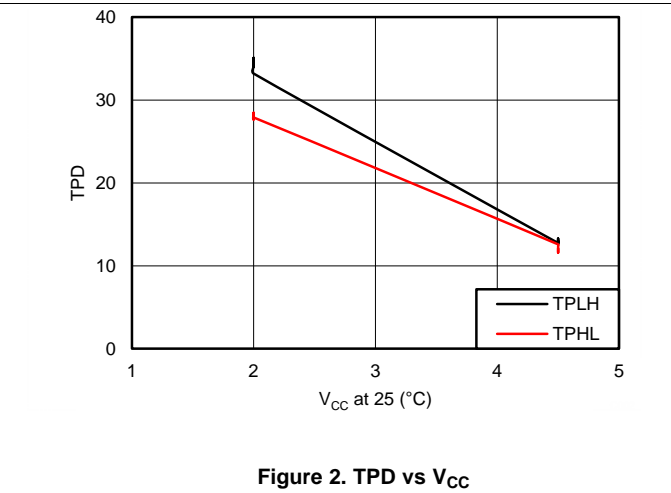
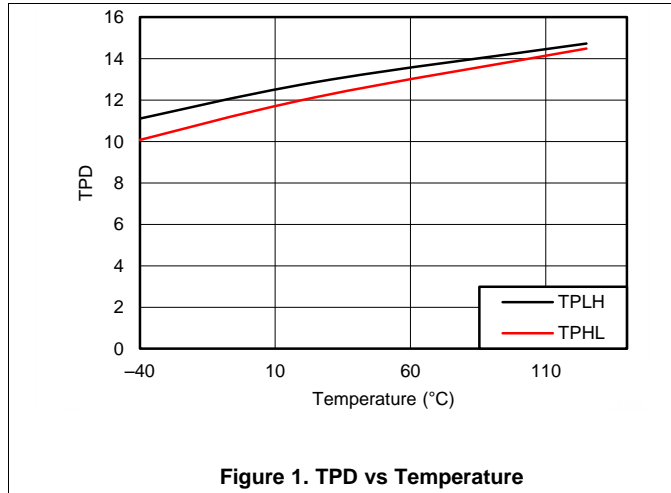

## 7 Parameter Measurement Information

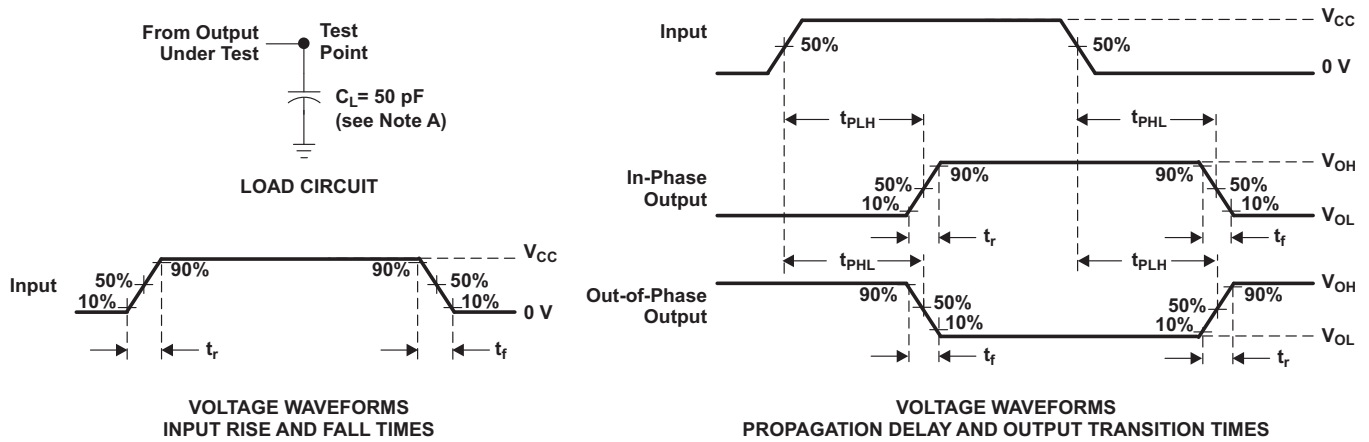

- A.  $C_L$  includes probe and test-fixture capacitance.
- B. Phase relationships between waveforms were chosen arbitrarily. All input pulses are supplied by generators having the following characteristics:  $PRR \leq \text{MHz}$ ,  $Z_O = 50 \Omega$ ,  $t_r = 6 \text{ ns}$ ,  $t_f = 6 \text{ ns}$ .
- C. The outputs are measured one at a time with one input transition per measurement.
- D.  $t_{PLH}$  and  $t_{PHL}$  are the same as  $t_{pd}$ .

**Figure 3. Load Circuit and Voltage Waveforms**

## 8 Detailed Description

### 8.1 Overview

The SNx4HC04 device contains six inverter gates. Each inverter gate performs the function of  $Y = \bar{A}$ .

### 8.2 Functional Block Diagram

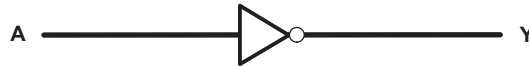

**Figure 4. Logic Diagram (Positive Logic)**

### 8.3 Feature Description

The SNx4HC series of devices offer a wide operating voltage range from 2 V to 6 V. The outputs can drive up to 10 LSTTL loads. The SNx4HC04 offers low power consumption of 20  $\mu$ A maximum  $I_{CC}$  and typical propagation delays of  $t_{pd} = 8$  ns. At 5 V, the outputs have  $\pm 4$  mA of output drive capability. Inputs have low input current leakage of 1  $\mu$ A maximum.

### 8.4 Device Functional Modes

**Table 1. Function Table  
(Each Inverter)**

INPUT A	OUTPUT Y
H	L
L	H

## 9 Application and Implementation

### NOTE

Information in the following applications sections is not part of the TI component specification, and TI does not warrant its accuracy or completeness. TI's customers are responsible for determining suitability of components for their purposes. Customers should validate and test their design implementation to confirm system functionality.

### 9.1 Application Information

The SNX4HC04 is a low-drive CMOS device that can be used for a multitude of inverting buffer type functions. The device can produce 4 mA of drive current at 5 V, making it ideal for driving multiple outputs and good for low-noise applications.

### 9.2 Typical Application

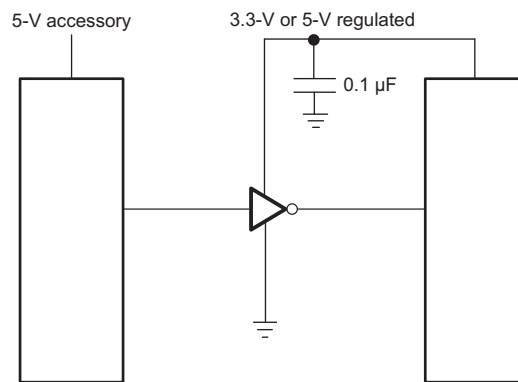

**Figure 5. Typical Application Schematic**

#### 9.2.1 Design Requirements

This device uses CMOS technology and has balanced output drive. Take care to avoid bus contention because it can drive currents that would exceed maximum limits. The high drive also creates fast edges into light loads, so routing and load conditions should be considered to prevent ringing.

#### 9.2.2 Detailed Design Procedure

1. Recommended Input Conditions
  - For rise time and fall time specifications, see  $\Delta t/\Delta V$  in [Recommended Operating Conditions](#).
  - For specified High and low levels, see  $V_{IH}$  and  $V_{IL}$  in [Recommended Operating Conditions](#).
  - Inputs are overvoltage tolerant allowing them to go as high as 5.5 V at any valid  $V_{CC}$ .
2. Recommend Output Conditions
  - Load currents should not exceed 25 mA per output and 50 mA total for the part.
  - Outputs should not be pulled above  $V_{CC}$ .

**Typical Application (continued)**

**9.2.3 Application Curve**

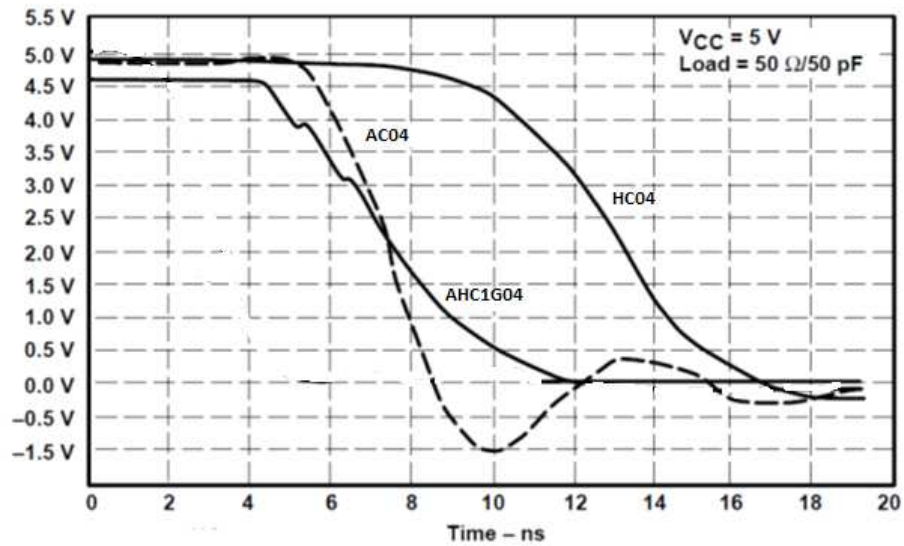

**Figure 6. Typical Technology Output Drive Curve**

## 10 Power Supply Recommendations

The power supply can be any voltage between the MIN and MAX supply voltage rating located in [Recommended Operating Conditions](#).

Each  $V_{CC}$  pin should have a good bypass capacitor to prevent power disturbance. For devices with a single supply, TI recommends a 0.1- $\mu\text{F}$  bypass capacitor. If there are multiple  $V_{CC}$  pins, TI recommends a 0.01- $\mu\text{F}$  or 0.022- $\mu\text{F}$  bypass capacitors for each power pin. It is acceptable to parallel multiple bypass capacitors to reject different frequencies of noise. A 0.1  $\mu\text{F}$  and 1  $\mu\text{F}$  bypass capacitors are commonly used in parallel. For best results, install the bypass capacitor as close to the power pin as possible for best.

## 11 Layout

### 11.1 Layout Guidelines

When using multiple bit logic devices, inputs should not float. In many cases, functions or parts of functions of digital logic devices are unused. Some examples are when only two inputs of a triple-input AND gate are used, or when only 3 of the 4-buffer gates are used. Such input pins should not be left unconnected because the undefined voltages at the outside connections result in undefined operational states.

Specified in [Figure 7](#) are rules that must be observed under all circumstances. All unused inputs of digital logic devices must be connected to a high or low bias to prevent them from floating. The logic level that should be applied to any particular unused input depends on the function of the device. Generally they will be tied to GND or  $V_{CC}$ , whichever makes more sense or is more convenient. It is acceptable to float outputs unless the part is a transceiver. If the transceiver has an output enable pin, it will disable the outputs section of the part when asserted. This will not disable the input section of the I/Os so they also cannot float when disabled.

### 11.2 Layout Example

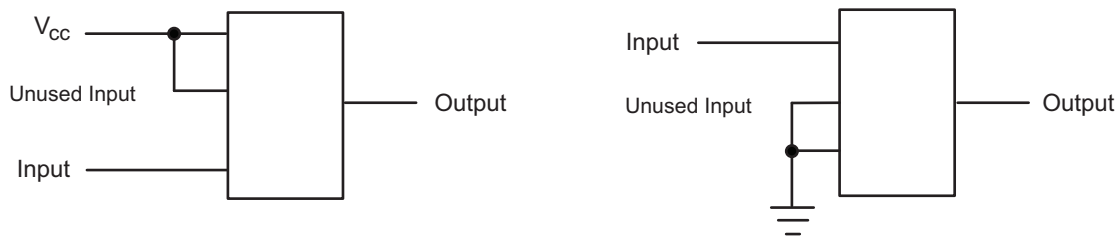

**Figure 7. Layout Diagram**

## 12 Device and Documentation Support

### 12.1 Related Links

The following table lists quick access links. Categories include technical documents, support and community resources, tools and software, and quick access to sample or buy.

**Table 2. Related Links**

PARTS	PRODUCT FOLDER	SAMPLE & BUY	TECHNICAL DOCUMENTS	TOOLS & SOFTWARE	SUPPORT & COMMUNITY
SN54HC04	<a href="#">Click here</a>	<a href="#">Click here</a>	<a href="#">Click here</a>	<a href="#">Click here</a>	<a href="#">Click here</a>
SN74HC04	<a href="#">Click here</a>	<a href="#">Click here</a>	<a href="#">Click here</a>	<a href="#">Click here</a>	<a href="#">Click here</a>

### 12.2 Community Resource

The following links connect to TI community resources. Linked contents are provided "AS IS" by the respective contributors. They do not constitute TI specifications and do not necessarily reflect TI's views; see TI's [Terms of Use](#).

**TI E2E™ Online Community** *TI's Engineer-to-Engineer (E2E) Community*. Created to foster collaboration among engineers. At [e2e.ti.com](http://e2e.ti.com), you can ask questions, share knowledge, explore ideas and help solve problems with fellow engineers.

**Design Support** *TI's Design Support* Quickly find helpful E2E forums along with design support tools and contact information for technical support.

### 12.3 Trademarks

E2E is a trademark of Texas Instruments.  
All other trademarks are the property of their respective owners.

### 12.4 Electrostatic Discharge Caution



These devices have limited built-in ESD protection. The leads should be shorted together or the device placed in conductive foam during storage or handling to prevent electrostatic damage to the MOS gates.

### 12.5 Glossary

[SLYZ022](#) — *TI Glossary*.

This glossary lists and explains terms, acronyms, and definitions.

## 13 Mechanical, Packaging, and Orderable Information

The following pages include mechanical, packaging, and orderable information. This information is the most current data available for the designated devices. This data is subject to change without notice and revision of this document. For browser-based versions of this data sheet, refer to the left-hand navigation.

**PACKAGING INFORMATION**

Orderable Device	Status (1)	Package Type	Package Drawing	Pins	Package Qty	Eco Plan (2)	Lead/Ball Finish (6)	MSL Peak Temp (3)	Op Temp (°C)	Device Marking (4/5)	Samples
5962-8409801VCA	ACTIVE	CDIP	J	14	1	TBD	A42	N / A for Pkg Type	-55 to 125	5962-8409801VC A SNV54HC04J	<a href="#">Samples</a>
5962-8409801VDA	ACTIVE	CFP	W	14	1	TBD	A42	N / A for Pkg Type	-55 to 125	5962-8409801VD A SNV54HC04W	<a href="#">Samples</a>
84098012A	ACTIVE	LCCC	FK	20	1	TBD	POST-PLATE	N / A for Pkg Type	-55 to 125	84098012A SNJ54HC 04FK	<a href="#">Samples</a>
8409801CA	ACTIVE	CDIP	J	14	1	TBD	A42	N / A for Pkg Type	-55 to 125	8409801CA SNJ54HC04J	<a href="#">Samples</a>
8409801DA	ACTIVE	CFP	W	14	1	TBD	A42	N / A for Pkg Type	-55 to 125	8409801DA SNJ54HC04W	<a href="#">Samples</a>
JM38510/65701B2A	ACTIVE	LCCC	FK	20	1	TBD	POST-PLATE	N / A for Pkg Type	-55 to 125	JM38510/ 65701B2A	<a href="#">Samples</a>
JM38510/65701BCA	ACTIVE	CDIP	J	14	1	TBD	A42	N / A for Pkg Type	-55 to 125	JM38510/ 65701BCA	<a href="#">Samples</a>
M38510/65701B2A	ACTIVE	LCCC	FK	20	1	TBD	POST-PLATE	N / A for Pkg Type	-55 to 125	JM38510/ 65701B2A	<a href="#">Samples</a>
M38510/65701BCA	ACTIVE	CDIP	J	14	1	TBD	A42	N / A for Pkg Type	-55 to 125	JM38510/ 65701BCA	<a href="#">Samples</a>
SN54HC04J	ACTIVE	CDIP	J	14	1	TBD	A42	N / A for Pkg Type	-55 to 125	SN54HC04J	<a href="#">Samples</a>
SN74HC04D	ACTIVE	SOIC	D	14	50	Green (RoHS & no Sb/Br)	CU NIPDAU	Level-1-260C-UNLIM	-40 to 85	HC04	<a href="#">Samples</a>
SN74HC04DBR	ACTIVE	SSOP	DB	14	2000	Green (RoHS & no Sb/Br)	CU NIPDAU	Level-1-260C-UNLIM	-40 to 85	HC04	<a href="#">Samples</a>
SN74HC04DBRE4	ACTIVE	SSOP	DB	14	2000	Green (RoHS & no Sb/Br)	CU NIPDAU	Level-1-260C-UNLIM	-40 to 85	HC04	<a href="#">Samples</a>
SN74HC04DBRG4	ACTIVE	SSOP	DB	14	2000	Green (RoHS & no Sb/Br)	CU NIPDAU	Level-1-260C-UNLIM	-40 to 85	HC04	<a href="#">Samples</a>
SN74HC04DE4	ACTIVE	SOIC	D	14	50	Green (RoHS & no Sb/Br)	CU NIPDAU	Level-1-260C-UNLIM	-40 to 85	HC04	<a href="#">Samples</a>
SN74HC04DR	ACTIVE	SOIC	D	14	2500	Green (RoHS & no Sb/Br)	CU NIPDAU   CU SN	Level-1-260C-UNLIM	-40 to 85	HC04	<a href="#">Samples</a>

Orderable Device	Status (1)	Package Type	Package Drawing	Pins	Package Qty	Eco Plan (2)	Lead/Ball Finish (6)	MSL Peak Temp (3)	Op Temp (°C)	Device Marking (4/5)	Samples
SN74HC04DRE4	ACTIVE	SOIC	D	14	2500	Green (RoHS & no Sb/Br)	CU NIPDAU	Level-1-260C-UNLIM	-40 to 85	HC04	<a href="#">Samples</a>
SN74HC04DRG3	ACTIVE	SOIC	D	14	2500	Green (RoHS & no Sb/Br)	CU SN	Level-1-260C-UNLIM	-40 to 85	HC04	<a href="#">Samples</a>
SN74HC04DRG4	ACTIVE	SOIC	D	14	2500	Green (RoHS & no Sb/Br)	CU NIPDAU	Level-1-260C-UNLIM	-40 to 85	HC04	<a href="#">Samples</a>
SN74HC04DT	ACTIVE	SOIC	D	14	250	Green (RoHS & no Sb/Br)	CU NIPDAU	Level-1-260C-UNLIM	-40 to 85	HC04	<a href="#">Samples</a>
SN74HC04N	ACTIVE	PDIP	N	14	25	Green (RoHS & no Sb/Br)	CU NIPDAU   CU SN	N / A for Pkg Type	-40 to 85	SN74HC04N	<a href="#">Samples</a>
SN74HC04NE4	ACTIVE	PDIP	N	14	25	Green (RoHS & no Sb/Br)	CU NIPDAU	N / A for Pkg Type	-40 to 85	SN74HC04N	<a href="#">Samples</a>
SN74HC04NSR	ACTIVE	SO	NS	14	2000	Green (RoHS & no Sb/Br)	CU NIPDAU	Level-1-260C-UNLIM	-40 to 85	HC04	<a href="#">Samples</a>
SN74HC04NSRG4	ACTIVE	SO	NS	14	2000	Green (RoHS & no Sb/Br)	CU NIPDAU	Level-1-260C-UNLIM	-40 to 85	HC04	<a href="#">Samples</a>
SN74HC04PW	ACTIVE	TSSOP	PW	14	90	Green (RoHS & no Sb/Br)	CU NIPDAU	Level-1-260C-UNLIM	-40 to 85	HC04	<a href="#">Samples</a>
SN74HC04PWR	ACTIVE	TSSOP	PW	14	2000	Green (RoHS & no Sb/Br)	CU NIPDAU   CU SN	Level-1-260C-UNLIM	-40 to 85	HC04	<a href="#">Samples</a>
SN74HC04PWRG4	ACTIVE	TSSOP	PW	14	2000	Green (RoHS & no Sb/Br)	CU NIPDAU	Level-1-260C-UNLIM	-40 to 85	HC04	<a href="#">Samples</a>
SN74HC04PWT	ACTIVE	TSSOP	PW	14	250	Green (RoHS & no Sb/Br)	CU NIPDAU	Level-1-260C-UNLIM	-40 to 85	HC04	<a href="#">Samples</a>
SNJ54HC04FK	ACTIVE	LCCC	FK	20	1	TBD	POST-PLATE	N / A for Pkg Type	-55 to 125	84098012A SNJ54HC 04FK	<a href="#">Samples</a>
SNJ54HC04J	ACTIVE	CDIP	J	14	1	TBD	A42	N / A for Pkg Type	-55 to 125	8409801CA SNJ54HC04J	<a href="#">Samples</a>
SNJ54HC04W	ACTIVE	CFP	W	14	1	TBD	A42	N / A for Pkg Type	-55 to 125	8409801DA SNJ54HC04W	<a href="#">Samples</a>

(1) The marketing status values are defined as follows:

**ACTIVE:** Product device recommended for new designs.

**LIFEBUY:** TI has announced that the device will be discontinued, and a lifetime-buy period is in effect.

**NRND:** Not recommended for new designs. Device is in production to support existing customers, but TI does not recommend using this part in a new design.

**PREVIEW:** Device has been announced but is not in production. Samples may or may not be available.

---

**OBSOLETE:** TI has discontinued the production of the device.

(2) **RoHS:** TI defines "RoHS" to mean semiconductor products that are compliant with the current EU RoHS requirements for all 10 RoHS substances, including the requirement that RoHS substance do not exceed 0.1% by weight in homogeneous materials. Where designed to be soldered at high temperatures, "RoHS" products are suitable for use in specified lead-free processes. TI may reference these types of products as "Pb-Free".

**RoHS Exempt:** TI defines "RoHS Exempt" to mean products that contain lead but are compliant with EU RoHS pursuant to a specific EU RoHS exemption.

**Green:** TI defines "Green" to mean the content of Chlorine (Cl) and Bromine (Br) based flame retardants meet JS709B low halogen requirements of  $\leq 1000$ ppm threshold. Antimony trioxide based flame retardants must also meet the  $\leq 1000$ ppm threshold requirement.

(3) MSL, Peak Temp. - The Moisture Sensitivity Level rating according to the JEDEC industry standard classifications, and peak solder temperature.

(4) There may be additional marking, which relates to the logo, the lot trace code information, or the environmental category on the device.

(5) Multiple Device Markings will be inside parentheses. Only one Device Marking contained in parentheses and separated by a "~" will appear on a device. If a line is indented then it is a continuation of the previous line and the two combined represent the entire Device Marking for that device.

(6) Lead/Ball Finish - Orderable Devices may have multiple material finish options. Finish options are separated by a vertical ruled line. Lead/Ball Finish values may wrap to two lines if the finish value exceeds the maximum column width.

**Important Information and Disclaimer:** The information provided on this page represents TI's knowledge and belief as of the date that it is provided. TI bases its knowledge and belief on information provided by third parties, and makes no representation or warranty as to the accuracy of such information. Efforts are underway to better integrate information from third parties. TI has taken and continues to take reasonable steps to provide representative and accurate information but may not have conducted destructive testing or chemical analysis on incoming materials and chemicals. TI and TI suppliers consider certain information to be proprietary, and thus CAS numbers and other limited information may not be available for release.

In no event shall TI's liability arising out of such information exceed the total purchase price of the TI part(s) at issue in this document sold by TI to Customer on an annual basis.

**OTHER QUALIFIED VERSIONS OF SN54HC04, SN54HC04-SP, SN74HC04 :**

- Catalog: [SN74HC04](#), [SN54HC04](#)
  
- Automotive: [SN74HC04-Q1](#), [SN74HC04-Q1](#)
  
- Military: [SN54HC04](#)
  
- Space: [SN54HC04-SP](#)

NOTE: Qualified Version Definitions:

- Catalog - TI's standard catalog product
- Automotive - Q100 devices qualified for high-reliability automotive applications targeting zero defects
- Military - QML certified for Military and Defense Applications
- Space - Radiation tolerant, ceramic packaging and qualified for use in Space-based application

## TAPE AND REEL INFORMATION

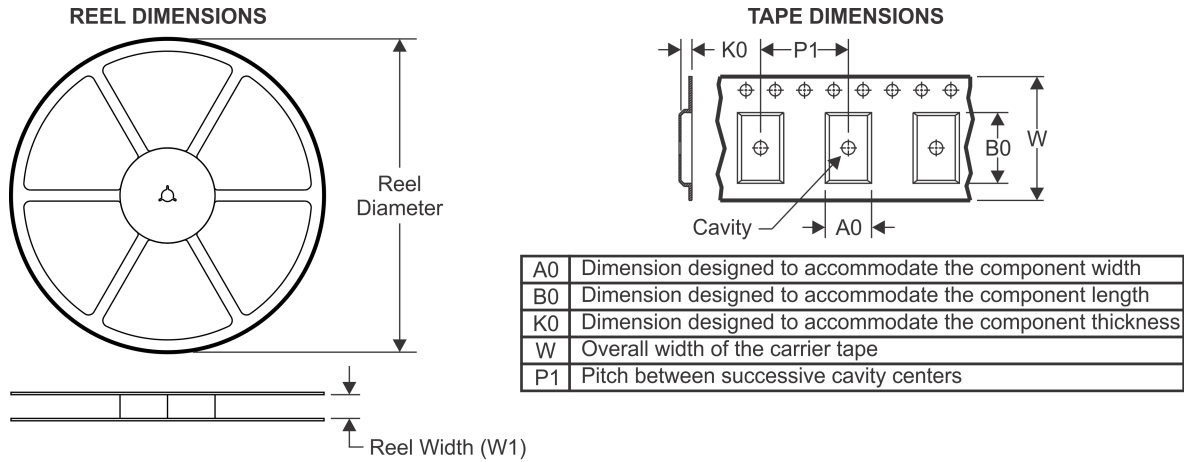

### QUADRANT ASSIGNMENTS FOR PIN 1 ORIENTATION IN TAPE



\*All dimensions are nominal

Device	Package Type	Package Drawing	Pins	SPQ	Reel Diameter (mm)	Reel Width W1 (mm)	A0 (mm)	B0 (mm)	K0 (mm)	P1 (mm)	W (mm)	Pin1 Quadrant
SN74HC04DR	SOIC	D	14	2500	330.0	16.4	6.5	9.0	2.1	8.0	16.0	Q1
SN74HC04DR	SOIC	D	14	2500	330.0	16.8	6.5	9.5	2.1	8.0	16.0	Q1
SN74HC04DR	SOIC	D	14	2500	330.0	16.4	6.5	9.0	2.1	8.0	16.0	Q1
SN74HC04DRG3	SOIC	D	14	2500	330.0	16.8	6.5	9.5	2.1	8.0	16.0	Q1
SN74HC04DRG4	SOIC	D	14	2500	330.0	16.4	6.5	9.0	2.1	8.0	16.0	Q1
SN74HC04DRG4	SOIC	D	14	2500	330.0	16.4	6.5	9.0	2.1	8.0	16.0	Q1
SN74HC04DT	SOIC	D	14	250	330.0	16.4	6.5	9.0	2.1	8.0	16.0	Q1
SN74HC04PWR	TSSOP	PW	14	2000	330.0	12.4	6.9	5.6	1.6	8.0	12.0	Q1
SN74HC04PWR	TSSOP	PW	14	2000	330.0	12.4	6.9	5.6	1.6	8.0	12.0	Q1
SN74HC04PWRG4	TSSOP	PW	14	2000	330.0	12.4	6.9	5.6	1.6	8.0	12.0	Q1
SN74HC04PWT	TSSOP	PW	14	250	330.0	12.4	6.9	5.6	1.6	8.0	12.0	Q1

**TAPE AND REEL BOX DIMENSIONS**

\*All dimensions are nominal

Device	Package Type	Package Drawing	Pins	SPQ	Length (mm)	Width (mm)	Height (mm)
SN74HC04DR	SOIC	D	14	2500	367.0	367.0	38.0
SN74HC04DR	SOIC	D	14	2500	364.0	364.0	27.0
SN74HC04DR	SOIC	D	14	2500	333.2	345.9	28.6
SN74HC04DRG3	SOIC	D	14	2500	364.0	364.0	27.0
SN74HC04DRG4	SOIC	D	14	2500	367.0	367.0	38.0
SN74HC04DRG4	SOIC	D	14	2500	333.2	345.9	28.6
SN74HC04DT	SOIC	D	14	250	210.0	185.0	35.0
SN74HC04PWR	TSSOP	PW	14	2000	367.0	367.0	35.0
SN74HC04PWR	TSSOP	PW	14	2000	364.0	364.0	27.0
SN74HC04PWRG4	TSSOP	PW	14	2000	367.0	367.0	35.0
SN74HC04PWT	TSSOP	PW	14	250	367.0	367.0	35.0

FK (S-CQCC-N\*\*)

LEADLESS CERAMIC CHIP CARRIER

28 TERMINAL SHOWN



NO. OF TERMINALS **	A		B	
	MIN	MAX	MIN	MAX
20	0.342 (8,69)	0.358 (9,09)	0.307 (7,80)	0.358 (9,09)
28	0.442 (11,23)	0.458 (11,63)	0.406 (10,31)	0.458 (11,63)
44	0.640 (16,26)	0.660 (16,76)	0.495 (12,58)	0.560 (14,22)
52	0.740 (18,78)	0.761 (19,32)	0.495 (12,58)	0.560 (14,22)
68	0.938 (23,83)	0.962 (24,43)	0.850 (21,6)	0.858 (21,8)
84	1.141 (28,99)	1.165 (29,59)	1.047 (26,6)	1.063 (27,0)



4040140/D 01/11

- NOTES:
- All linear dimensions are in inches (millimeters).
  - This drawing is subject to change without notice.
  - This package can be hermetically sealed with a metal lid.
  - Falls within JEDEC MS-004

# MECHANICAL DATA

NS (R-PDSO-G\*\*)

PLASTIC SMALL-OUTLINE PACKAGE

14-PINS SHOWN



- NOTES:
- A. All linear dimensions are in millimeters.
  - B. This drawing is subject to change without notice.
  - C. Body dimensions do not include mold flash or protrusion, not to exceed 0,15.

W (R-GDFP-F14)

CERAMIC DUAL FLATPACK



- NOTES:
- A. All linear dimensions are in inches (millimeters).
  - B. This drawing is subject to change without notice.
  - C. This package can be hermetically sealed with a ceramic lid using glass frit.
  - D. Index point is provided on cap for terminal identification only.
  - E. Falls within MIL STD 1835 GDFP1-F14

J 14

**GENERIC PACKAGE VIEW**  
**CDIP - 5.08 mm max height**  
CERAMIC DUAL IN LINE PACKAGE



Images above are just a representation of the package family, actual package may vary.  
Refer to the product data sheet for package details.

4040083-5/G

J0014A



# PACKAGE OUTLINE

CDIP - 5.08 mm max height

CERAMIC DUAL IN LINE PACKAGE



4214771/A 05/2017

NOTES:

1. All controlling linear dimensions are in inches. Dimensions in brackets are in millimeters. Any dimension in brackets or parenthesis are for reference only. Dimensioning and tolerancing per ASME Y14.5M.
2. This drawing is subject to change without notice.
3. This package is hermetically sealed with a ceramic lid using glass frit.
4. Index point is provided on cap for terminal identification only and on press ceramic glass frit seal only.
5. Falls within MIL-STD-1835 and GDIP1-T14.

# EXAMPLE BOARD LAYOUT

J0014A

CDIP - 5.08 mm max height

CERAMIC DUAL IN LINE PACKAGE



LAND PATTERN EXAMPLE  
NON-SOLDER MASK DEFINED  
SCALE: 5X



4214771/A 05/2017



D (R-PDSO-G14)

PLASTIC SMALL OUTLINE



4211283-3/E 08/12

- NOTES:
- All linear dimensions are in millimeters.
  - This drawing is subject to change without notice.
  - Publication IPC-7351 is recommended for alternate designs.
  - Laser cutting apertures with trapezoidal walls and also rounding corners will offer better paste release. Customers should contact their board assembly site for stencil design recommendations. Refer to IPC-7525 for other stencil recommendations.
  - Customers should contact their board fabrication site for solder mask tolerances between and around signal pads.



PW (R-PDSO-G14)

PLASTIC SMALL OUTLINE



4211284-2/G 08/15

- NOTES:
- All linear dimensions are in millimeters.
  - This drawing is subject to change without notice.
  - Publication IPC-7351 is recommended for alternate designs.
  - Laser cutting apertures with trapezoidal walls and also rounding corners will offer better paste release. Customers should contact their board assembly site for stencil design recommendations. Refer to IPC-7525 for other stencil recommendations.
  - Customers should contact their board fabrication site for solder mask tolerances between and around signal pads.



DB (R-PDSO-G\*\*)

PLASTIC SMALL-OUTLINE

28 PINS SHOWN



- NOTES: A. All linear dimensions are in millimeters.  
 B. This drawing is subject to change without notice.  
 C. Body dimensions do not include mold flash or protrusion not to exceed 0,15.  
 D. Falls within JEDEC MO-150

## IMPORTANT NOTICE AND DISCLAIMER

TI PROVIDES TECHNICAL AND RELIABILITY DATA (INCLUDING DATASHEETS), DESIGN RESOURCES (INCLUDING REFERENCE DESIGNS), APPLICATION OR OTHER DESIGN ADVICE, WEB TOOLS, SAFETY INFORMATION, AND OTHER RESOURCES "AS IS" AND WITH ALL FAULTS, AND DISCLAIMS ALL WARRANTIES, EXPRESS AND IMPLIED, INCLUDING WITHOUT LIMITATION ANY IMPLIED WARRANTIES OF MERCHANTABILITY, FITNESS FOR A PARTICULAR PURPOSE OR NON-INFRINGEMENT OF THIRD PARTY INTELLECTUAL PROPERTY RIGHTS.

These resources are intended for skilled developers designing with TI products. You are solely responsible for (1) selecting the appropriate TI products for your application, (2) designing, validating and testing your application, and (3) ensuring your application meets applicable standards, and any other safety, security, or other requirements. These resources are subject to change without notice. TI grants you permission to use these resources only for development of an application that uses the TI products described in the resource. Other reproduction and display of these resources is prohibited. No license is granted to any other TI intellectual property right or to any third party intellectual property right. TI disclaims responsibility for, and you will fully indemnify TI and its representatives against, any claims, damages, costs, losses, and liabilities arising out of your use of these resources.

TI's products are provided subject to TI's Terms of Sale ([www.ti.com/legal/termsofsale.html](http://www.ti.com/legal/termsofsale.html)) or other applicable terms available either on [ti.com](http://ti.com) or provided in conjunction with such TI products. TI's provision of these resources does not expand or otherwise alter TI's applicable warranties or warranty disclaimers for TI products.

Mailing Address: Texas Instruments, Post Office Box 655303, Dallas, Texas 75265  
Copyright © 2019, Texas Instruments Incorporated

## Looking for pricing, stock, or lifecycle information?

Click below to explore more details on WIN SOURCE:

 [View SN74HC04DTG4 on WIN SOURCE](#)

 [Texas Instruments](#) Information

## Optimize Your Supply Chain with WIN SOURCE Solutions

-  Global Sourcing Solution
-  Obsolete Management
-  Cost Control Management
-  Shortage Management
-  Alternative Solution
-  Excess Inventory Management