

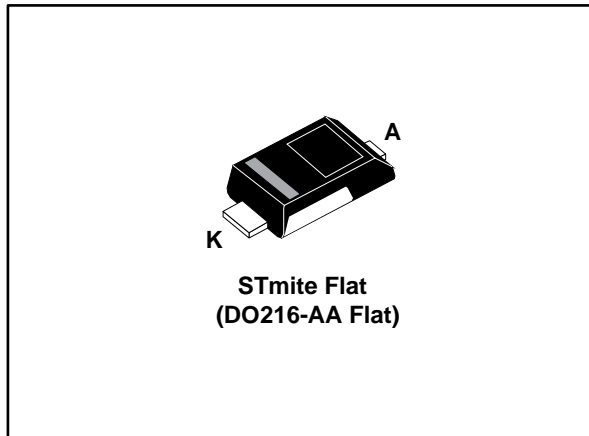

**THE DATASHEET OF
SMM4F33A-TR**





Description

The SMM4F Transil serie has been designed to protect sensitive equipment against electro-static discharges according to IEC 61000-4-2, MIL STD 883 Method 3015, and electrical over stress such as IEC 61000-4-4 and 5. They are generally for surges below 400 W 10/1000 μ s.

This planar technology makes it compatible with high-end equipment and SMPS where low leakage current and high junction temperature are required to provide reliability and stability over time. Their low clamping voltages provide a better safety margin to protect sensitive circuits with extended life time expectancy.

Packaged in STmite Flat, this minimizes PCB space consumption (footprint in accordance with IPC 7531 standard). Transil is a trademark of STMicroelectronics.

Features

- Typical peak pulse power:
 - 400 W (10/1000 μ s)
 - 2.4 kW (8/20 μ s)
- Stand-off voltage range: from 5 V to 33 V
- Unidirectional type
- Low leakage current:
 - 0.2 μ A at 25 °C
 - 1 μ A at 85 °C
- Operating T_j max: 175 °C
- JEDEC registered package outline
- RoHS package
- Halogen free molding compound

Complies with the following standards

- IEC 61000-4-2 level 4:
 - 15 kV (air discharge)
 - 8 kV (contact discharge)
- MIL STD 883G-Method 3015-7: class3
 - 25 kV (human body model)

1 Characteristics

Table 1: Absolute maximum ratings ($T_{amb} = 25\text{ }^{\circ}\text{C}$)

Symbol	Parameter	Value	Unit	
V_{PP}	Peak pulse voltage (IEC 61000-4-2 contact discharge)	30	kV	
P_{PP}	Peak pulse power dissipation	$T_j \text{ initial} = T_{amb}$	400	W
P	Power dissipation on infinite heatsink	$T_{amb} = 125\text{ }^{\circ}\text{C}$	2.5	W
I_{FSM}	Non repetitive surge peak forward current for unidirectional types	$t_p = 10\text{ ms}$ $T_j \text{ initial} = T_{amb}$	30	A
T_{stg}	Storage temperature range	-65 to +175	$^{\circ}\text{C}$	
T_j	Operating junction temperature range	-55 to +175	$^{\circ}\text{C}$	
T_L	Maximum lead temperature for soldering during 10 s	260	$^{\circ}\text{C}$	

Table 2: Thermal resistances

Symbol	Parameter	Value	Unit
$R_{th(j-l)}$	Junction to leads	20	$^{\circ}\text{C/W}$
$R_{th(j-a)}$	Junction to ambient on PCB with recommended pad layout	250	

Figure 1: Electrical characteristics - parameter definitions ($T_{amb} = 25\text{ }^{\circ}\text{C}$)

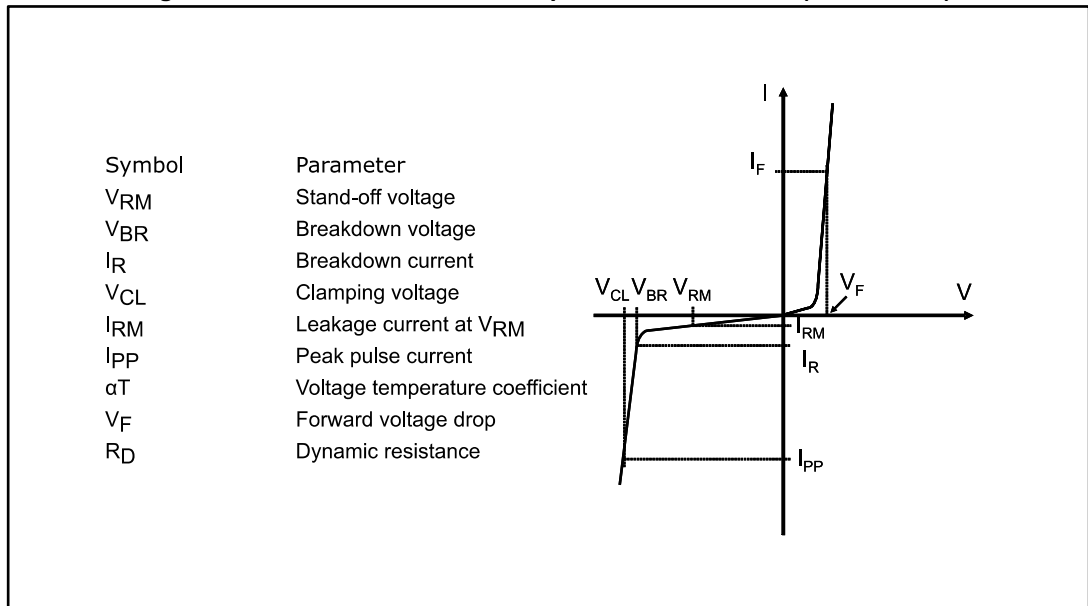

Table 3: Electrical characteristics - parameter values (T_{amb} = 25 °C)

Type	I _{RM} max. at V _{RM}			V _{BR} at I _R ⁽¹⁾				V _{CL} at I _{PP} 10/1000 μs			R _D ⁽²⁾ 10/1000 μs	V _{CL} at I _{PP} 8/20 μs		RD 8/20 μs ⁽²⁾	αT ⁽³⁾
	25 °C	85 °C		Min.	Typ.	Max.		Max.			Max.				Max.
	μA		V	V				mA	V	A	Ω	V	A	Ω	10 ⁻⁴ /°C
SMM4F5.0A	10	50	5.0	6.46	6.80	7.14	10	9.2	43.5	0.047	13.4	179	0.035	5.7	
SMM4F6.0A	10	50	6.0	6.65	7.00	7.35	10	10.3	38.8	0.076	13.7	175	0.036	5.9	
SMM4F6.5A	10	50	6.5	7.13	7.50	7.88	10	11.2	37.5	0.093	14.5	166	0.039	6.1	
SMM4F8.5A	10	50	8.5	9.5	10.0	10.5	1	14.4	27.7	0.141	19.5	140	0.064	7.3	
SMM4F10A	0.2	1	10	11.4	12.0	12.6	1	17.0	23.5	0.187	21.7	127	0.071	7.8	
SMM4F12A	0.2	1	12	13.3	14.0	14.7	1	19.9	20.1	0.259	25.3	112	0.094	8.3	
SMM4F13A	0.2	1	13	14.3	15.0	15.8	1	21.5	18.6	0.309	27.2	106	0.108	8.4	
SMM4F15A	0.2	1	15	17.1	18.0	18.9	1	24.4	16.4	0.335	32.5	90	0.150	8.8	
SMM4F18A	0.2	1	18	20.9	22.0	23.1	1	29.2	14.0	0.436	39.3	76	0.214	9.2	
SMM4F20A	0.2	1	20	22.8	24.0	25.2	1	32.4	12.0	0.600	42.8	70	0.250	9.4	
SMM4F24A	0.2	1	24	26.6	28.01	29.4	1	38.9	9.5	1.00	50	61	0.338	9.6	
SMM4F26A	0.2	1	26	28.5	30.0	31.5	1	42.1	9.0	1.18	53.5	58	0.380	9.7	
SMM4F28A	0.2	1	28	31.4	33.0	34.7	1	45.4	8.0	1.34	59.0	53	0.456	9.8	
SMM4F33A	0.2	1	33	37.1	39.0	41.0	1	53.3	7.0	1.76	69.7	45	0.636	10.0	

Notes:

(1) Pulse test: t_p < 50 ms.

(2) To calculate maximum clamping voltage at other surge currents, use the following formula:

$$V_{CLmax} = R_D \times I_{PP} + V_{BRmax}$$

(3) To calculate V_{BR} versus junction temperature, use the following formula:

$$V_{BR} \text{ at } T_j = V_{BR} @ 25 \text{ °C} \times (1 + \alpha T \times (T_j - 25))$$

Figure 2: Definition of I_{PP} pulse

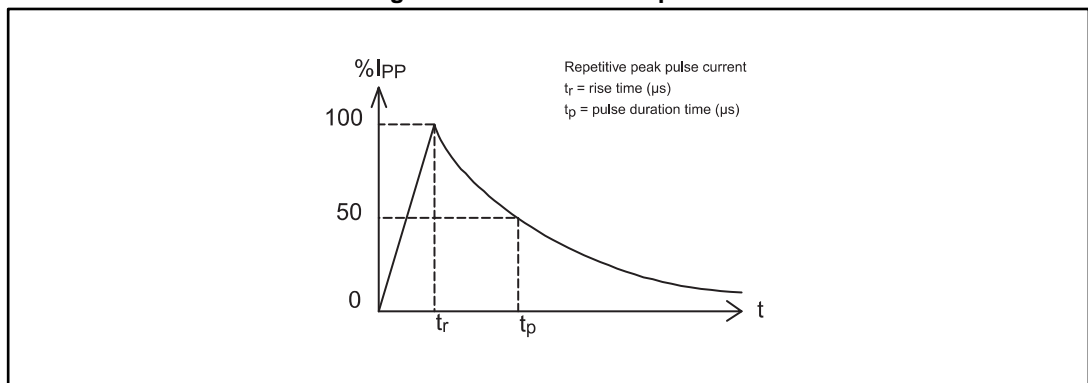

1.1 Characteristics (curves)

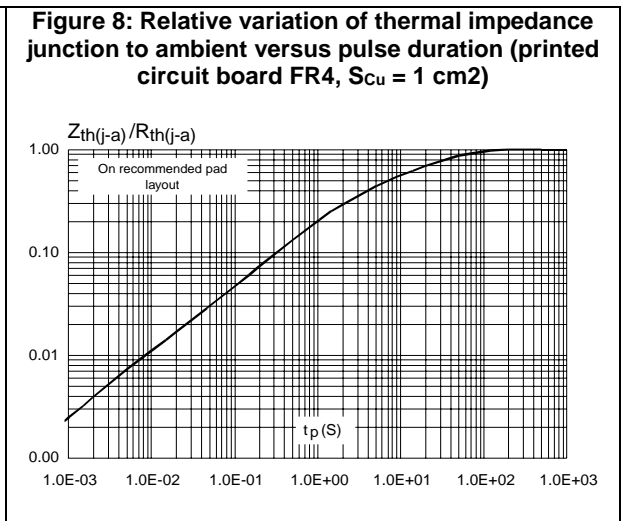
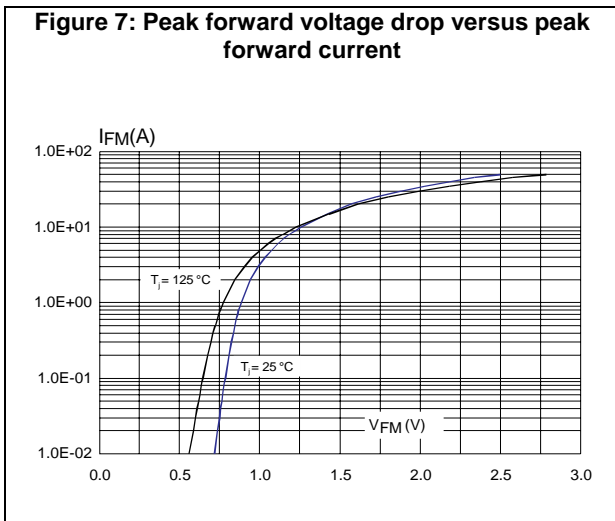
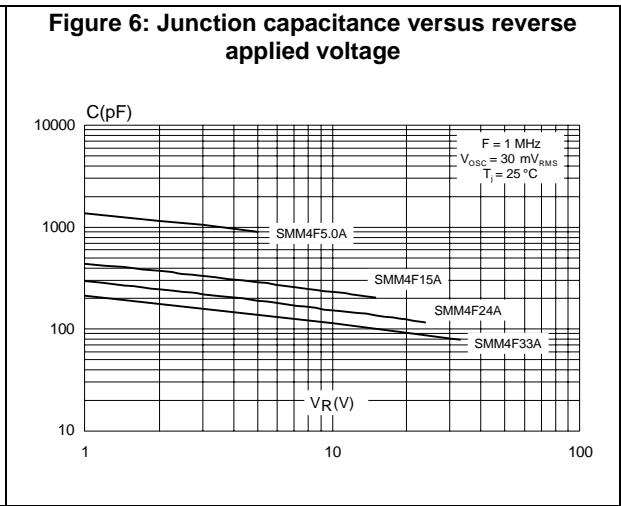
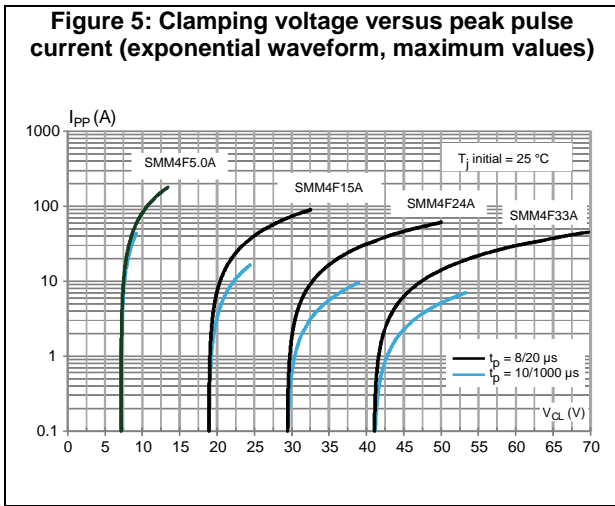
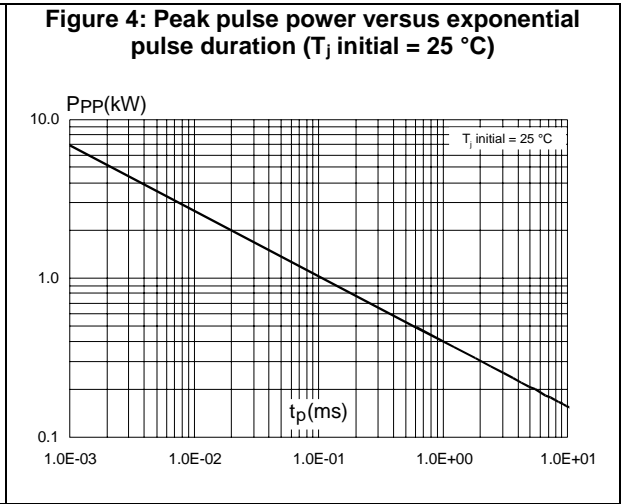
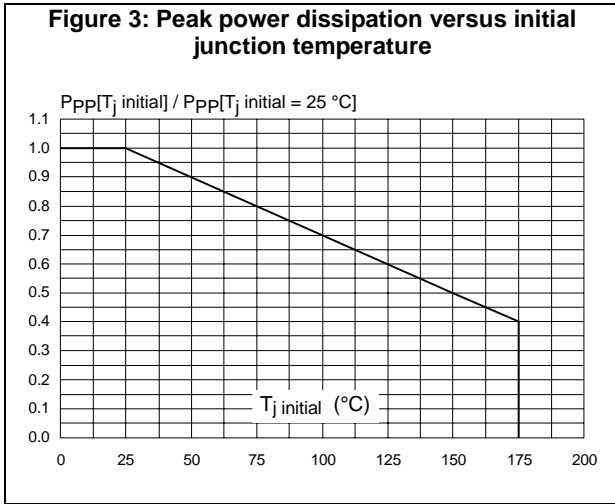

Figure 9: Thermal resistance junction to ambient versus copper surface under each lead (printed circuit board FR4, $e_{Cu} = 35 \mu m$)

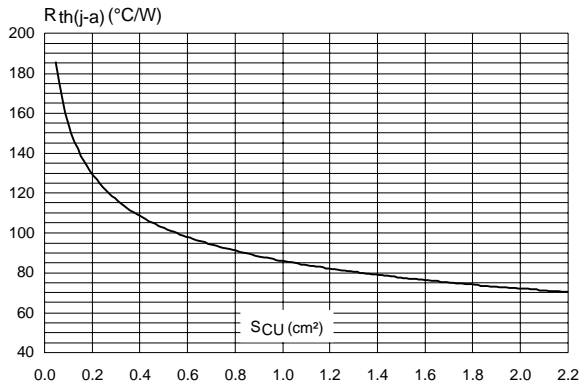
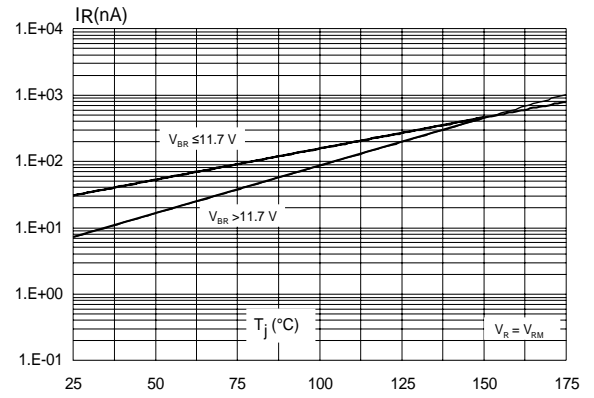

Figure 10: Leakage current versus junction temperature (typical values)



2 Package information

In order to meet environmental requirements, ST offers these devices in different grades of ECOPACK® packages, depending on their level of environmental compliance. ECOPACK® specifications, grade definitions and product status are available at: www.st.com. ECOPACK® is an ST trademark.

- Case: JEDEC DO216-AA Flat molded plastic over planar junction
- Terminals: solder plated, solderable per MIL-STD-750, method 2026
- Polarity: for unidirectional types the band indicates cathode.
- Flammability: epoxy is rated UL94V-0
- RoHS package

2.1 STmite Flat package information

Figure 11: STmite Flat package outline

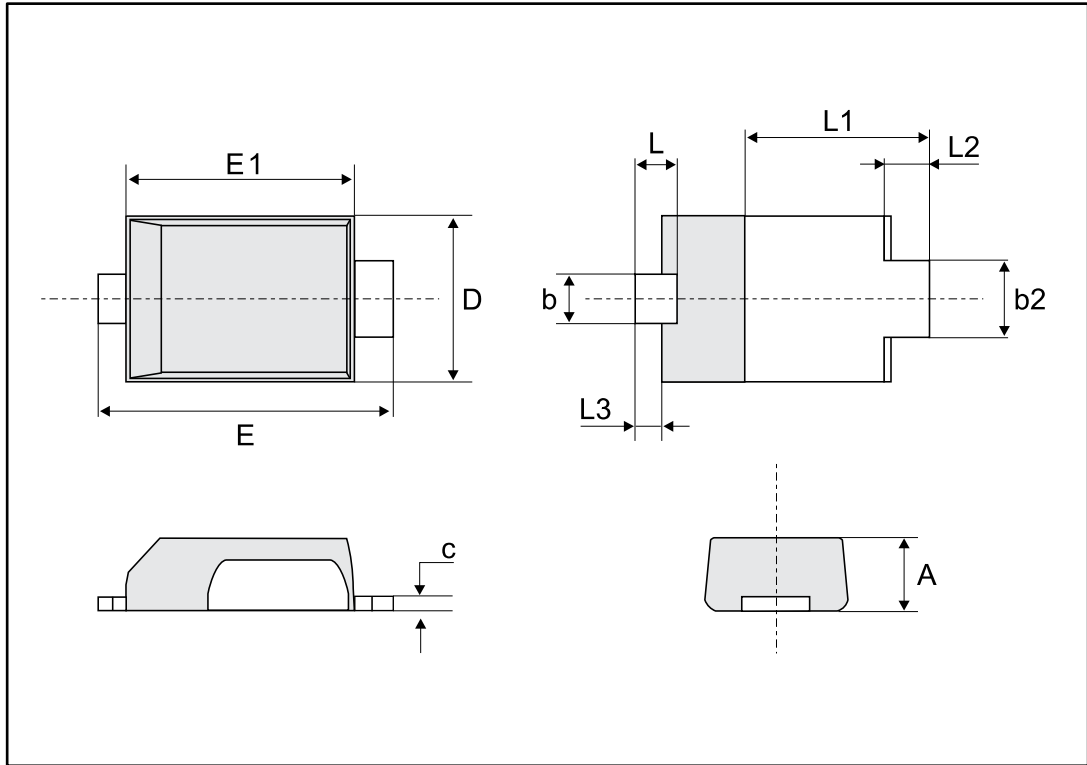

Table 4: STmite Flat mechanical data

Ref.	Dimensions					
	Millimeters			Inches		
	Min.	Typ.	Max.	Min.	Typ.	Max.
A	0.80	0.85	0.95	0.031	0.033	0.037
b	0.40	0.55	0.65	0.016	0.022	0.026
b2	0.70	0.85	1.00	0.027	0.033	0.039
c	0.10	0.15	0.25	0.004	0.006	0.009
D	1.75	1.90	2.05	0.069	0.075	0.081
E	3.60	3.80	3.90	0.142	0.150	0.154
E1	2.80	2.95	3.10	0.110	0.116	0.122
L	0.50	0.55	0.80	0.020	0.022	0.031
L1	2.10	2.40	2.60	0.083	0.094	0.102
L2	0.45	0.60	0.75	0.018	0.024	0.030
L3	0.20	0.35	0.50	0.008	0.014	0.020

Figure 12: Footprint recommendations, dimensions in mm (inches)

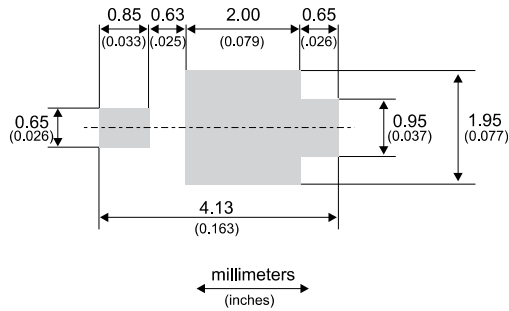

Figure 13: Marking layout (refer to ordering information table for marking)

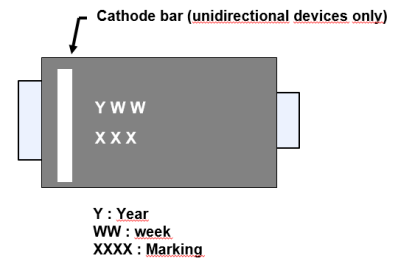
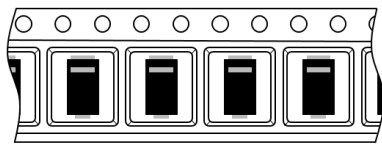

Figure 14: Package orientation in reel



Taped according to EIA-481
 Note: Pocket dimensions are not on scale
 Pocket shape may vary depending on package
 On bidirectional devices, marking and logo may be not always in the same direction

Figure 15: Tape and reel orientation

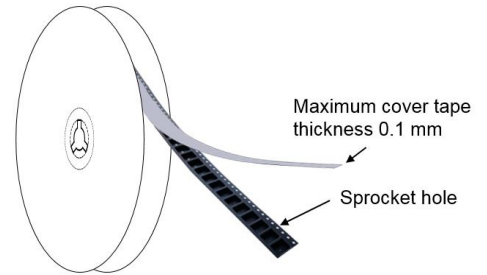

Figure 16: Reel dimensions (mm)

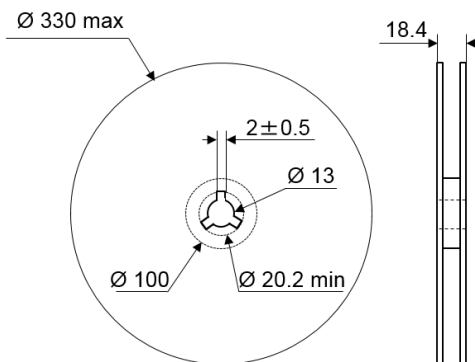

Figure 17: Inner box dimensions (mm)

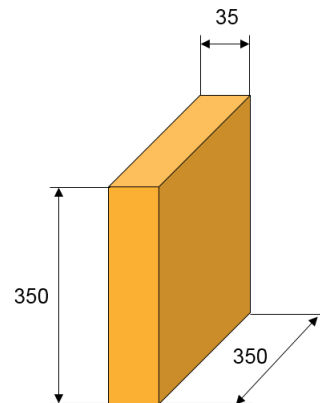

Figure 18: Tape and reel outline

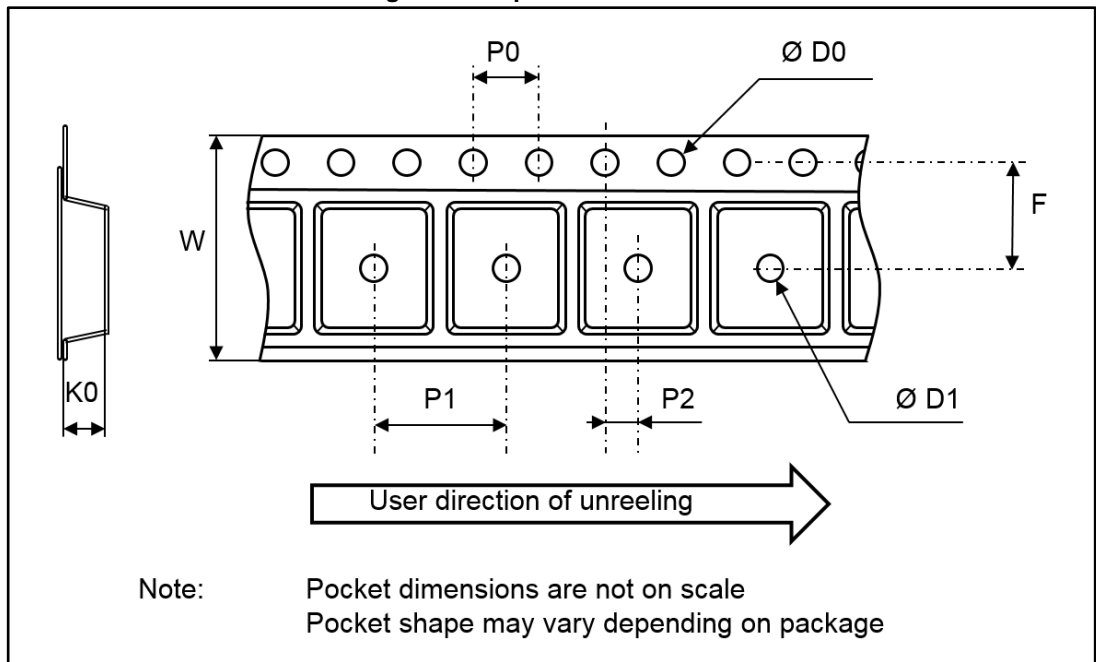

Table 5: Tape and reel mechanical data

Ref.	Dimensions		
	Millimeters		
	Min.	Typ.	Max.
P0	3.9	4	4.1
P1	3.9	4	4.1
P2	1.9	2	2.1
ØD0	1.5	1.55	1.6
ØD1	1.5		
F	5.2	5.25	5.3
K0	1.2	1.3	1.4
W	11.7	12	12.3

3 Ordering information

Figure 19: Ordering information scheme

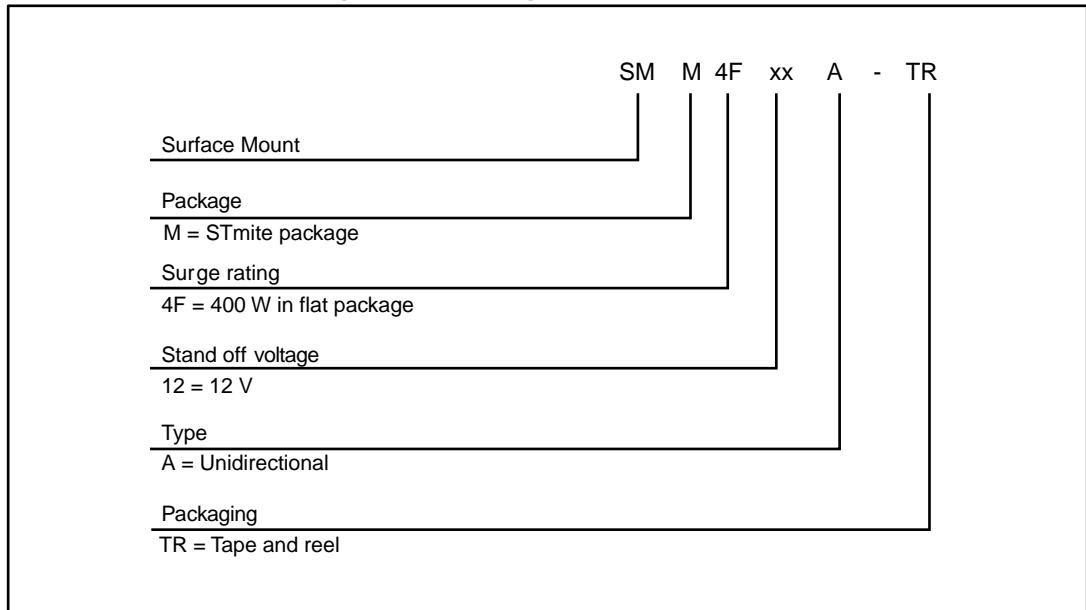

Table 6: Ordering information

Order code	Marking	Package	Weight	Base qty.	Delivery mode
SMM4FxxA-TR	See Table 6 .	STmite Flat	16 mg	12000	Tape and reel

Table 7: Marking

Type	Marking
SMM4F5.0A-TR	4UA
SMM4F6.0A-TR	4UB
SMM4F6.5A-TR	4UC
SMM4F8.5A-TR	4UD
SMM4F10A-TR	4UE
SMM4F12A-TR	4UF
SMM4F13A-TR	4UG
SMM4F15A-TR	4UH
SMM4F18A-TR	4UJ
SMM4F20A-TR	4UK
SMM4F24A-TR	4UM
SMM4F26A-TR	4UN
SMM4F28A-TR	4UO
SMM4F33A-TR	4UQ

4 Revision history

Table 8: Document revision history

Date	Revision	Changes
29-Nov-2007	1	First issue.
19-Dec-2007	2	Updated I_{PP} and R_D parameters in columns 10 and 11 of <i>Table 4</i> .
19-Aug-2014	3	Updated package name.
19-Jan-2017	4	Updated cover page and <i>Table 4</i> .

IMPORTANT NOTICE – PLEASE READ CAREFULLY

STMicroelectronics NV and its subsidiaries ("ST") reserve the right to make changes, corrections, enhancements, modifications, and improvements to ST products and/or to this document at any time without notice. Purchasers should obtain the latest relevant information on ST products before placing orders. ST products are sold pursuant to ST's terms and conditions of sale in place at the time of order acknowledgement.

Purchasers are solely responsible for the choice, selection, and use of ST products and ST assumes no liability for application assistance or the design of Purchasers' products.

No license, express or implied, to any intellectual property right is granted by ST herein.

Resale of ST products with provisions different from the information set forth herein shall void any warranty granted by ST for such product.



ST and the ST logo are trademarks of ST. All other product or service names are the property of their respective owners.

Information in this document supersedes and replaces information previously supplied in any prior versions of this document.

© 2017 STMicroelectronics – All rights reserved

Looking for pricing, stock, or lifecycle information?

Click below to explore more details on WIN SOURCE:

-  [View SMM4F33A-TR on WIN SOURCE](#)
-  [STMicroelectronics Information](#)

Optimize Your Supply Chain with WIN SOURCE Solutions

-  Global Sourcing Solution
-  Obsolete Management
-  Cost Control Management
-  Shortage Management
-  Alternative Solution
-  Excess Inventory Management