



**THE DATASHEET OF
LM48861TM/NOPB**



LM48861 Boomer® Audio Power Amplifier Series Ground-Referenced, Ultra Low Noise, Stereo Headphone Amplifier

Check for Samples: [LM48861](#), [LM48861TMBD](#)

FEATURES

- **Ground Referenced Outputs – Eliminates Output Coupling Capacitors**
- **Common-Mode Sensing**
- **Advanced Click-and-Pop Suppression**
- **Low Supply Current**
- **Minimum External Components**
- **Micro-Power Shutdown**
- **ESD Protection of 8kV HBM Contact**
- **Available in Space-Saving 12-Bump DSBGA Package**

APPLICATIONS

- **Mobile Phones**
- **Portable Electronic Devices**
- **MP3 Players**

KEY SPECIFICATIONS

- **Output Power/Channel at $V_{DD} = 1.5V$, THD+N = 1%**
 - $R_L = 16\Omega$ 12mW (typ)
 - $R_L = 32\Omega$ 13mW (typ)
- **Output Power/Channel at $V_{DD} = 1.8V$, THD+N = 1%**
 - $R_L = 16\Omega$ 24mW (typ)
 - $R_L = 32\Omega$ 22mW (typ)
- **Quiescent Power Supply Current at 1.5V 2mA (typ)**
- **PSRR at 217Hz 83dB (typ)**
- **Shutdown Current 0.01 μ A (typ)**

DESCRIPTION

The LM48861 is a single supply, ground-referenced stereo headphone amplifier. Part of TI's PowerWise™ product family, the LM48861 consumes only 3mW of power, yet still provides great audio performance. The ground-referenced architecture eliminates the larger DC blocking capacitors required by traditional headphone amplifier's saving board space and reducing cost.

The LM48861 features common-mode sensing that corrects for any differences between the amplifier ground and the potential at the headphone return terminal, minimizing noise created by any ground mismatches.

The LM48861 delivers 22mW/channel into a 32 Ω load with <1% THD+N with a 1.8V supply. Power supply requirements allow operation from 1.2V to 2.8V. High power supply rejection ratio (PSRR), 83dB at 217Hz, allows the device to operate in noisy environments without additional power supply conditioning. A low power shutdown mode reduces supply current consumption to 0.01 μ A.

Superior click and pop suppression eliminates audible transients on power-up/down and during shutdown. The LM48861 is available in an ultra-small 12-bump, 0.4mm pitch, DSBGA package (1.215mm x 1.615mm).



Please be aware that an important notice concerning availability, standard warranty, and use in critical applications of Texas Instruments semiconductor products and disclaimers thereto appears at the end of this data sheet.

PowerWise is a trademark of Texas Instruments.

All other trademarks are the property of their respective owners.

Typical Application

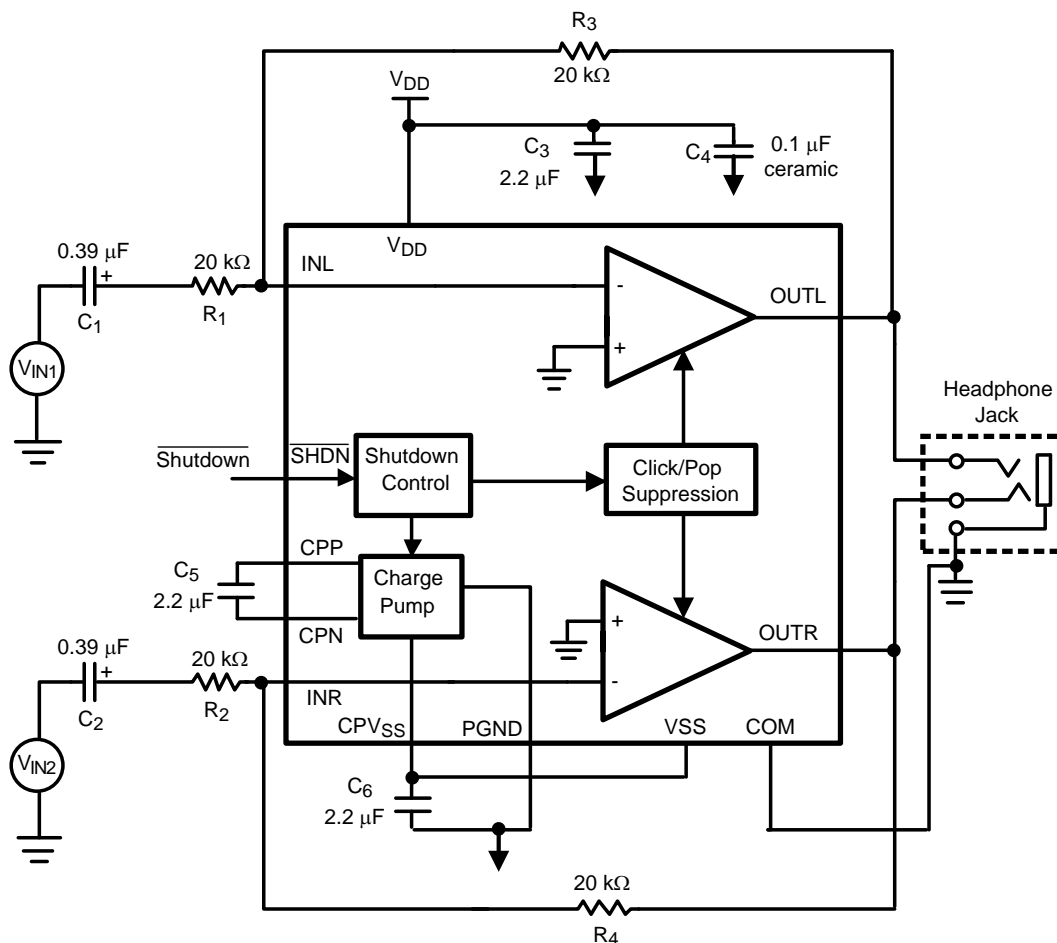

Figure 1. Typical Audio Amplifier Application Circuit

Connection Diagrams

Figure 2. YFQ Package
1.215mm x 1.615mm x 0.6mm
Top View
See Package Number YFQ0012AAA

BUMP DESCRIPTION

Bump	Name	Description
A1	CPP	Charge Pump Flying Capacitor Positive Terminal
A2	PGND	Power Ground
A3	CPN	Charge Pump Flying Capacitor Negative Terminal
B1	V _{DD}	Positive Power Supply
B2	$\overline{\text{SHDN}}$	Active Low Shutdown
B3	CPV _{SS}	Charge Pump Output
C1	OUTL	Left Channel Output
C2	V _{SS}	Negative Power Supply
C3	INL	Left Channel Input
D1	OUTR	Right Channel Output
D2	COM	Ground reference for inputs and HP
D3	INR	Right Channel Input

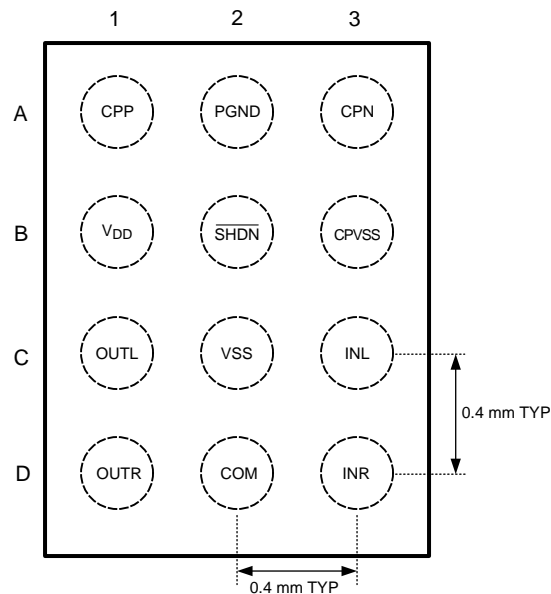

These devices have limited built-in ESD protection. The leads should be shorted together or the device placed in conductive foam during storage or handling to prevent electrostatic damage to the MOS gates.

Absolute Maximum Ratings⁽¹⁾⁽²⁾⁽³⁾

Supply Voltage ⁽¹⁾		3V
Storage Temperature		-65°C to +150°C
Input Voltage		-0.3V to V _{DD} + 0.3V
Power Dissipation ⁽⁴⁾		Internally Limited
ESD Ratings (HBM) ⁽⁵⁾		2000V
ESD Ratings(OUTL, OUTR) ⁽⁵⁾		8000V
ESD Susceptibility (Machine Model) ⁽⁶⁾		200V
Junction Temperature		150°C
Thermal Resistance	θ_{JA} (YFQ)	70°C/W (typ)

- (1) “*Absolute Maximum Ratings*” indicate limits beyond which damage to the device may occur, including inoperability and degradation of device reliability and/or performance. Functional operation of the device and/or non-degradation at the *Absolute Maximum Ratings* or other conditions beyond those indicated in the *Recommended Operating Conditions* is not implied. The *Recommended Operating Conditions* indicate conditions at which the device is functional and the device should not be operated beyond such conditions. All voltages are measured with respect to the ground pin, unless otherwise specified
- (2) The *Electrical Characteristics* tables list ensured specifications under the listed *Recommended Operating Conditions* except as otherwise modified or specified by the *Electrical Characteristics Conditions* and/or Notes. Typical specifications are estimations only and are not ensured.
- (3) If Military/Aerospace specified devices are required, please contact the TI Sales Office/ Distributors for availability and specifications.
- (4) Maximum allowable power dissipation is $P_{DMAX} = (T_{JMAX} - T_A) / \theta_{JA}$ or the number given in *Absolute Maximum Ratings*, whichever is lower.
- (5) Human body model, applicable std. JESD22-A114C.
- (6) Machine model, applicable std. JESD22-A115-A.

Operating Ratings

Temperature Range $T_{MIN} \leq T_A \leq T_{MAX}$		$-40^\circ\text{C} \leq T_A \leq +85^\circ\text{C}$
Supply Voltage (V _{DD})		$1.2\text{V} \leq V_{DD} \leq 2.8\text{V}$

Electrical Characteristics $V_{DD} = 1.5V^{(1)(2)}$

The following specifications apply for $V_{DD} = 1.5V$, $A_V = -1V/V$, $R_L = 32k\Omega$, $f = 1kHz$, unless otherwise specified. Limits apply for $T_A = 25^\circ C$.

Symbol	Parameter	Conditions	LM48861		Units (Limits)
			Typical ⁽³⁾	Limit ⁽⁴⁾	
I_{DD}	Quiescent Power Supply Current	$V_{IN} = 0V$, Both channels enabled	2	2.8	mA (max)
I_{SD}	Shutdown Current	Shutdown Enabled $V_{SHDN} = GND$	0.01	1.5	μA (max)
V_{OS}	Output Offset Voltage	$V_{IN} = 0V$, $R_L = 32\Omega$ Both channels enabled	0.5	1.5	mV (max)
V_{IH}	Shutdown Input Voltage High			1.4	V(min)
V_{IL}	Shutdown Input Voltage Low			0.4	V(max)
T_{WU}	Wake Up Time		500	700	μs (max)
P_O	Output Power	THD+N = 1% $R_L = 32\Omega$, $f = 1kHz$, Both channels in phase and active $V_{DD} = 1.5V$ $V_{DD} = 1.8V$	13 22	12 20	mW (min) mW (min)
		THD+N = 1% $R_L = 16\Omega$, $f = 1kHz$, Both channels in phase and active $V_{DD} = 1.5V$ $V_{DD} = 1.8V$	12 24		mW mW
$V_{LINE-OUT}$	Output Voltage to Line Out	$R_L = 10k\Omega$, $f = 1kHz$			
		$V_{DD} = 1.5V$, THD+N = 1%, $R_L = 10k\Omega$	1.1	1	V_{RMS} (min)
		$V_{DD} = 1.8V$, THD+N = 1%, $R_L = 10k\Omega$	1.3	1.2	V_{RMS} (min)
THD+N	Total Harmonic Distortion + Noise	$P_O = 8mW$, $f = 1kHz$, $R_L = 32\Omega$	0.04		%
		$P_O = 8mW$, $f = 1kHz$, $R_L = 16\Omega$	0.07		%
		$V_{OLIF} = 900mV_{RMS}$, $f = 1kHz$, $R_L = 10k\Omega$	0.001		%
PSRR	Power Supply Rejection Ratio	$V_{RIPPLE} = 200mV_{P-P}$ Sine, Inputs AC GND, $C1 = C2 = 0.39\mu F$			
		$f_{RIPPLE} = 217Hz$	83		dB
		$f_{RIPPLE} = 1kHz$	77		dB
		$f_{RIPPLE} = 15kHz$	57		dB
SNR	Signal-to-Noise Ratio	$R_L = 32\Omega$, $P_{OUT} = 8mW$ (A-weighted), $f = 1kHz$ $BW = 20Hz$ to $22kHz$	102		dB
X_{TALK}	Crosstalk	$R_L = 32\Omega$, $P_{OUT} = 5mW$, $f = 1kHz$	93		dB
N_{OUT}	Output Noise	A-weighted, $A_V = 5.1dB$ $R1 = R2 = 10k\Omega$, $R3 = R4 = 18k\Omega$	5		μV
C-P	Click-Pop	Inputs Grounded $BW = <10Hz$ to $>500kHz$	79		dB

- (1) "Absolute Maximum Ratings" indicate limits beyond which damage to the device may occur, including inoperability and degradation of device reliability and/or performance. Functional operation of the device and/or non-degradation at the *Absolute Maximum Ratings* or other conditions beyond those indicated in the *Recommended Operating Conditions* is not implied. The *Recommended Operating Conditions* indicate conditions at which the device is functional and the device should not be operated beyond such conditions. All voltages are measured with respect to the ground pin, unless otherwise specified.
- (2) The *Electrical Characteristics* tables list ensured specifications under the listed *Recommended Operating Conditions* except as otherwise modified or specified by the *Electrical Characteristics Conditions* and/or Notes. Typical specifications are estimations only and are not ensured.
- (3) Typical values represent most likely parametric norms at $T_A = +25^\circ C$, and at the *Recommended Operation Conditions* at the time of product characterization and are not ensured.
- (4) Datasheet min/max specification limits are ensured by test or statistical analysis.

Typical Performance Characteristics

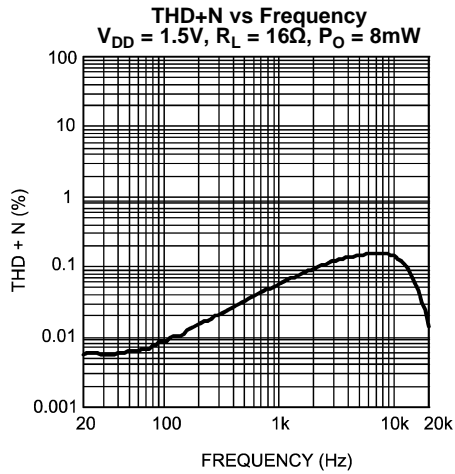

Figure 3.

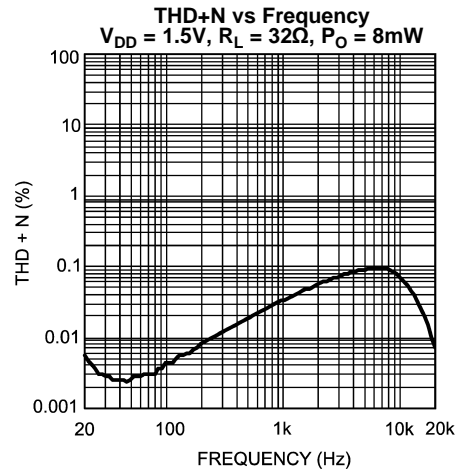

Figure 4.

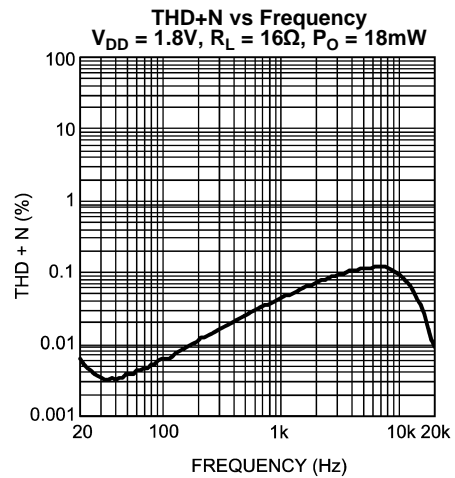

Figure 5.

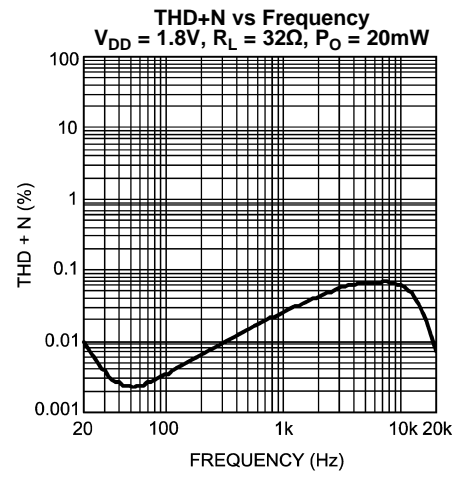

Figure 6.

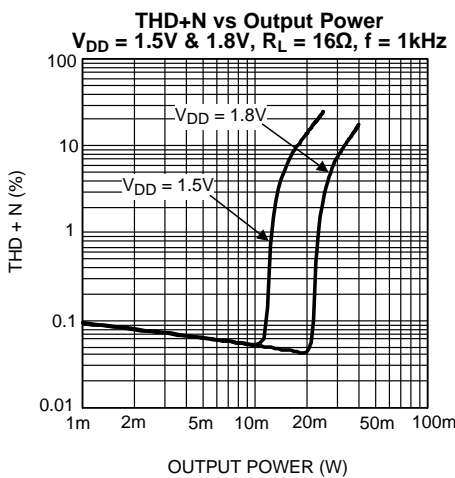

Figure 7.

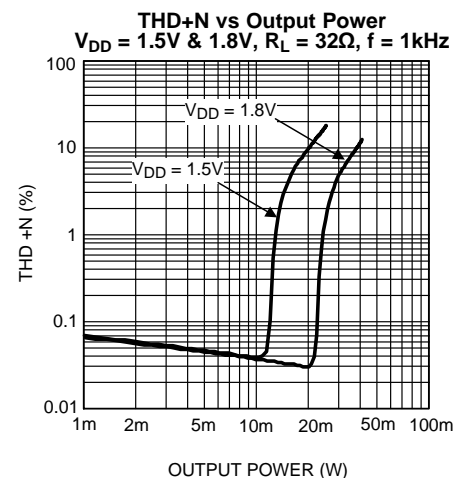

Figure 8.

Typical Performance Characteristics (continued)

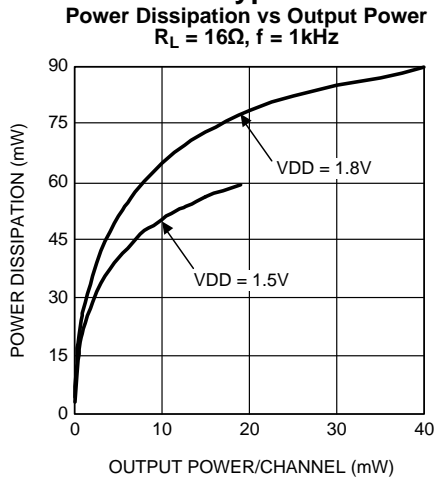

Figure 9.

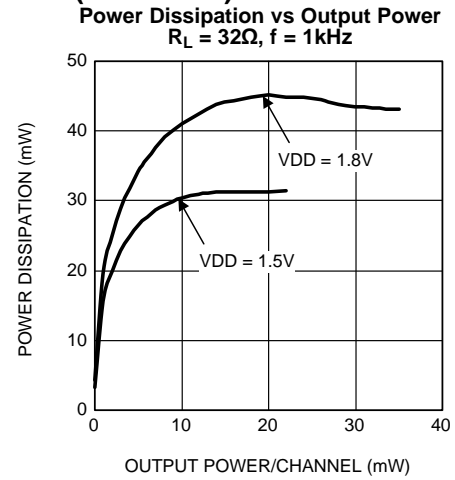

Figure 10.

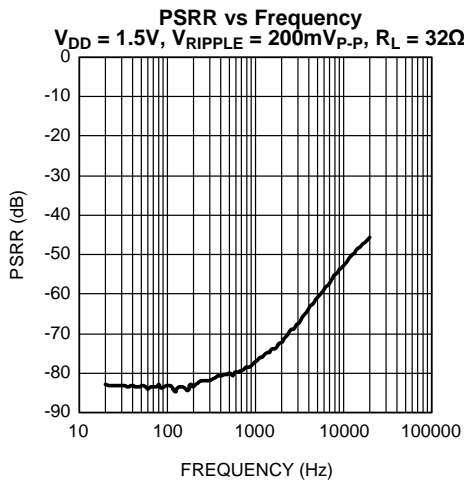

Figure 11.

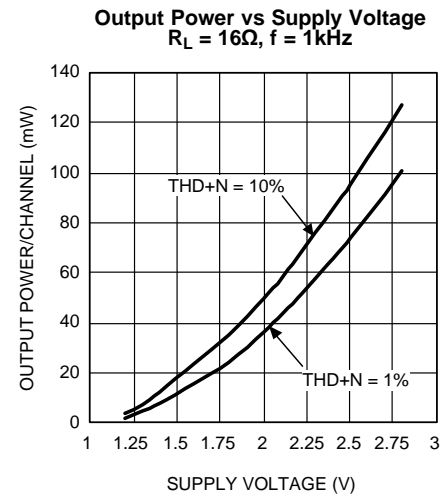

Figure 12.

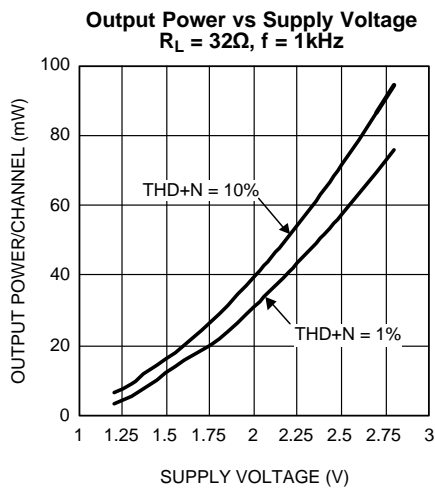

Figure 13.

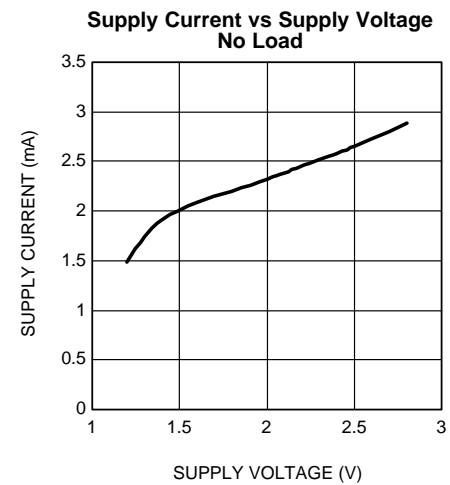
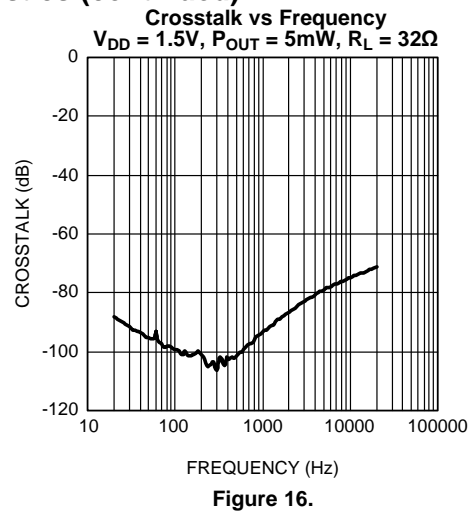
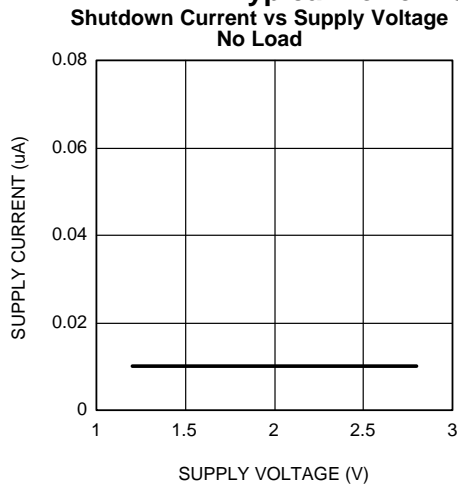

Figure 14.

Typical Performance Characteristics (continued)



APPLICATION INFORMATION

GENERAL AMPLIFIER FUNCTION

The LM48861 headphone amplifier features TI's ground referenced architecture that eliminates the large DC-blocking capacitors required at the outputs of traditional headphone amplifiers. A low-noise inverting charge pump creates a negative supply (CPV_{SS}) from the positive supply voltage (V_{DD}). The headphone amplifiers operate from these bipolar supplies, with the amplifier outputs biased about GND, instead of a nominal DC voltage (typically V_{DD}/2), like traditional amplifiers. Because there is no DC component to the headphone output signals, the large DC-blocking capacitors (typically 220µF) are not necessary, conserving board space and system cost, while improving frequency response.

COMMON MODE SENSE

The LM48861 features a ground (common mode) sensing feature. In noisy applications, or where the headphone jack is used as a line out to other devices, noise pick up and ground imbalance can degrade audio quality. The LM48861 COM input senses and corrects any noise at the headphone return, or any ground imbalance between the headphone return and device ground, improving audio reproduction. Connect COM directly to the headphone return terminal of the headphone jack [Figure 17](#). No additional external components are required. Connect COM to GND if the common-mode sense feature is not in use.

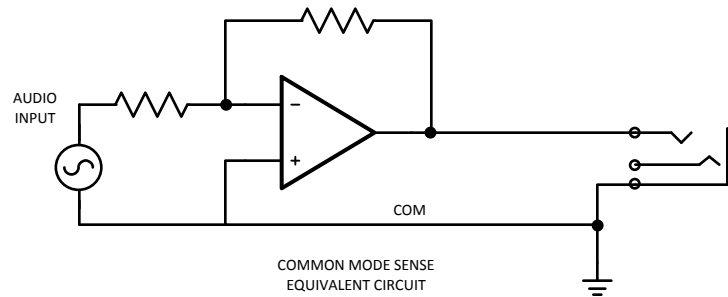

Figure 17.

MICRO POWER SHUTDOWN

The voltage applied to the shutdown ($\overline{\text{SHDN}}$) pin controls the LM48861's shutdown function. Activate micro-power shutdown by applying a logic-low voltage to the $\overline{\text{SHDN}}$ pin. When active, the LM48861's micro-power shutdown feature turns off the amplifier's bias circuitry, reducing the supply current. The trigger point is 0.4V (max) for a logic-low level, and 1.4V (min) for a logic-high level. The low 0.1µA (typ) shutdown current is achieved by applying a voltage that is as near as ground as possible to the $\overline{\text{SHDN}}$ pin. A voltage that is higher than ground may increase the shutdown current.

There are a few ways to control the micro-power shutdown. These include using a single-pole, single-throw switch, a microprocessor, or a microcontroller. When using a switch, connect an external 100kΩ pull-up resistor between the $\overline{\text{SHDN}}$ pin and GND. Connect the switch between the $\overline{\text{SHDN}}$ pin and V_{DD}. Select normal amplifier operation by closing the switch. Opening the switch connects the $\overline{\text{SHDN}}$ pin to ground, activating micro-power shutdown. The switch and resistor ensure that the $\overline{\text{SHDN}}$ pin will not float. This prevents unwanted state changes. In a system with a microprocessor or microcontroller, use a digital output to apply the control voltage to the $\overline{\text{SHDN}}$ pin. Driving the $\overline{\text{SHDN}}$ pin with active circuitry eliminates the pull-up resistor.

POWER DISSIPATION

Power dissipation is a major concern when using any power amplifier, especially one in mobile devices. In the LM48861, the power dissipation comes from the charge pump and two operational amplifiers. Refer to the [Figure 10 Power Dissipation vs Output Power](#) curve in the [Typical Performance Characteristics](#) section of the datasheet to find the power dissipation associated the output power level of the LM48861. The power dissipation should not exceed the maximum power dissipation point of the DSBGA package given in [Equation 1](#).

$$P_{\text{DMAX}} = (T_{\text{JMAX}} - T_{\text{A}}) / (\theta_{\text{JA}}) \quad (1)$$

For the LM48861TM DSBGA package, $\theta_{JA} = 70^{\circ}\text{C/W}$. $T_{JMAX} = 150^{\circ}\text{C}$, and T_A is the ambient temperature of the system surroundings.

PROPER SELECTION OF EXTERNAL COMPONENTS

Power Supply Bypassing/Filtering

Proper power supply bypassing is critical for low noise performance and high PSRR. Place the supply bypass capacitors as close to the supply pins as possible. Place a $1\mu\text{F}$ ceramic capacitor from V_{DD} to GND. Additional bulk capacitance may be added as required.

Charge Pump Capacitor Selection

Use low ESR ceramic capacitors (less than $100\text{m}\Omega$) for optimum performance.

Charge Pump Flying Capacitor (C5)

The flying capacitor (C5) affects the load regulation and output impedance of the charge pump. A C5 value that is too low results in a loss of current drive, leading to a loss of amplifier headroom. A higher valued C5 improves load regulation and lowers charge pump output impedance to an extent. Above $2.2\mu\text{F}$, the $R_{DS(ON)}$ of the charge pump switches and the ESR of C5 and C6 dominate the output impedance. A lower value capacitor can be used in systems with low maximum output power requirements.

Charge Pump Hold Capacitor (C6)

The value and ESR of the hold capacitor (C6) directly affects the ripple on CPV_{SS} . Increasing the value of C6 reduces output ripple. Decreasing the ESR of C6 reduces both output ripple and charge pump output impedance. A lower value capacitor can be used in systems with low maximum output power requirements.

Power Supply Bypassing /Filtering

Proper power supply bypassing is critical for low noise performance and high PSRR. Place the supply bypass capacitors as close to the device as possible. Typical applications employ a voltage regulator with $10\mu\text{F}$ and $0.1\mu\text{F}$ bypass capacitors that increase supply stability. These capacitors do not eliminate the need for bypassing of the LM48861 supply pins. A $1\mu\text{F}$ capacitor is recommended.

Input Capacitor Selection

The LM48861 requires input coupling capacitors. Input capacitors block the DC component of the audio signal, eliminating any conflict between the DC component of the audio source and the bias voltage of the LM48861. The input capacitors create a high-pass filter with the input resistors R_{IN} . The -3dB point of the high-pass filter is found using [Equation 2](#) below.

$$f = 1 / 2\pi R_{IN} C_{IN}$$

Where

- the value of R_{IN} is selected based on the gain-setting resistor selection. (2)

In relation to [Figure 1](#), $R_{IN} = R_1 = R_2$, $C_{IN} = C_1 = C_2$.

The input capacitors can also be used to remove low frequency content from the audio signal. Small speakers can not reproduce, and may even be damaged by low frequencies. High-pass filtering the audio signal helps protect the speakers. When the LM48861 is using a single-ended source, power supply noise on the ground is seen as an input signal. Setting the high-pass filter point above the power supply noise frequencies, 217Hz in a GSM phone, for example, filters out the noise such that it is not amplified and heard on the output. Capacitors with a tolerance of 10% or better are recommended for impedance matching and improved CMRR and PSRR.

PCB Layout Guidelines

Minimize trace impedance of the power, ground and all output traces for optimum performance. Voltage loss due to trace resistance between the LM48861 and the load results in decreased output power and efficiency. Trace resistance between the power supply and ground has the same effect as a poorly regulated supply, increased ripple and reduced peak output power. Use wide traces for power supply inputs and amplifier outputs to minimize losses due to trace resistance, as well as route heat away from the device. Proper grounding improves audio performance, minimizes crosstalk between channels and prevents switching noise from interfering with the audio signal. Use of power and ground planes is recommended.

As described in the Common Mode Sense section, the LM48861 features a ground sensing feature. On the PCB layout, connect the COM pin (pin D2) directly to the headphone jack ground and also to the left and right input grounds. This will help correct any noise or any ground imbalance between the headphone return, input, and the device ground, therefore improving audio reproduction.

The charge pump capacitors and traces connecting the capacitor to the device should be kept away from the input and output traces to avoid any switching noise injected into the input or output.

Demo Board Schematic and Layout

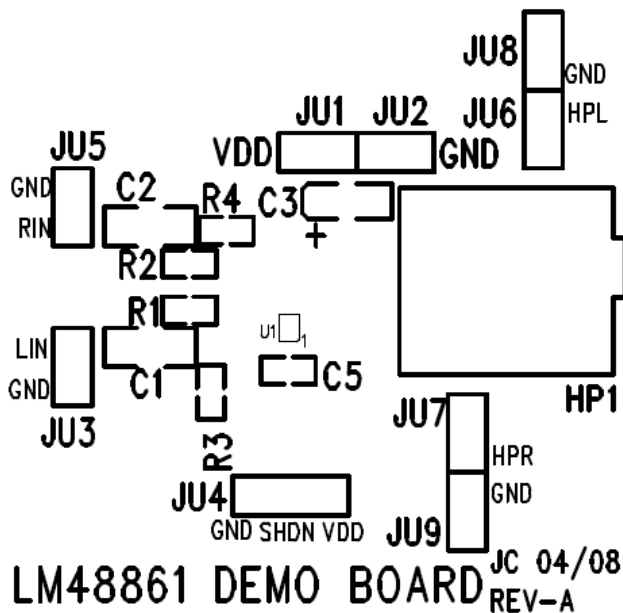

Figure 18. Top Silkscreen Layer

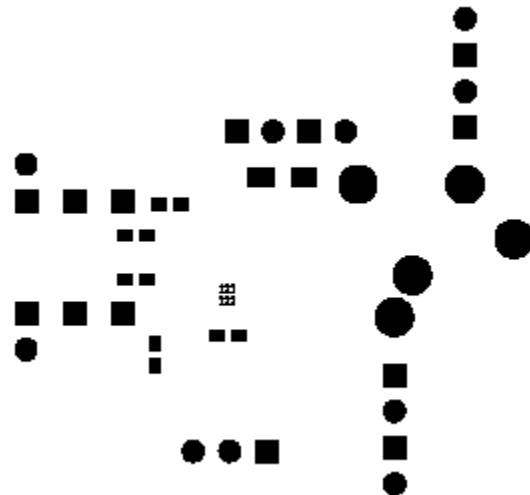

Figure 19. Top Solder Mask

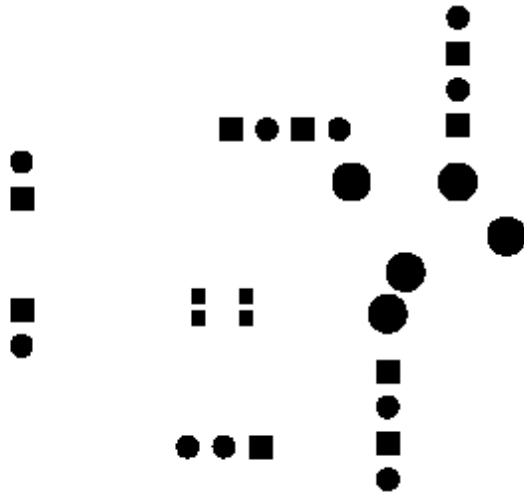

Figure 20. Bottom Solder Mask

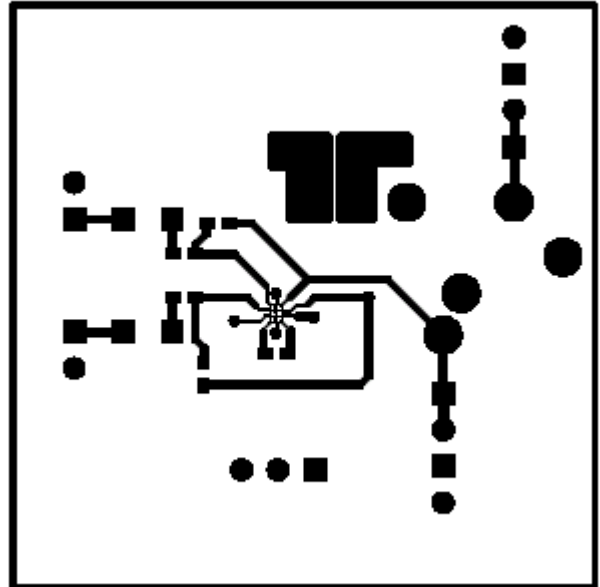

Figure 21. Top Layer

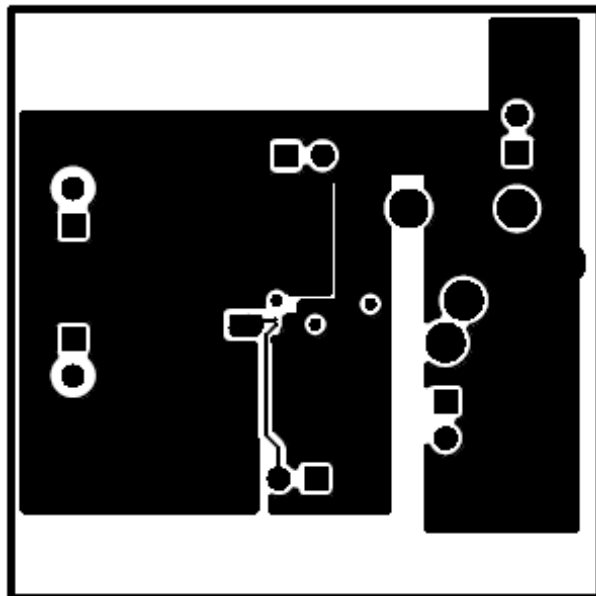

Figure 22. Layer 2

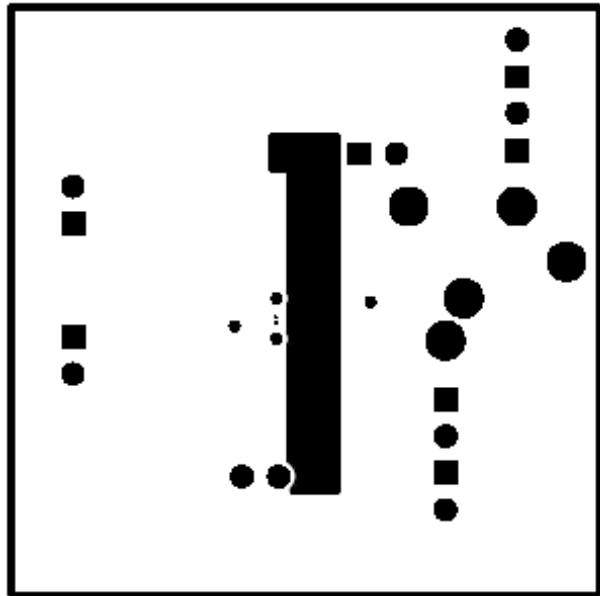

Figure 23. Layer 3

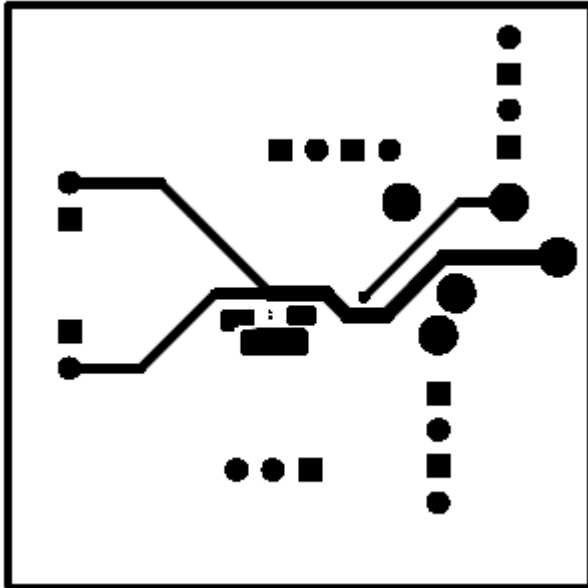

Figure 24. Bottom Layer



221800087-001 REV-B

Figure 25. Bottom Silkscreen

REVISION HISTORY

Rev	Date	Description
1.0	06/11/08	Initial release.
1.01	02/08/10	Input text edits.
B	05/02/2013	Changed layout of National Data Sheet to TI format.

PACKAGING INFORMATION

Orderable Device	Status (1)	Package Type	Package Drawing	Pins	Package Qty	Eco Plan (2)	Lead/Ball Finish (6)	MSL Peak Temp (3)	Op Temp (°C)	Device Marking (4/5)	Samples
LM48861TM/NOPB	ACTIVE	DSBGA	YFQ	12	250	Green (RoHS & no Sb/Br)	SNAGCU	Level-1-260C-UNLIM	-40 to 85	G K3	Samples

(1) The marketing status values are defined as follows:

ACTIVE: Product device recommended for new designs.

LIFEBUY: TI has announced that the device will be discontinued, and a lifetime-buy period is in effect.

NRND: Not recommended for new designs. Device is in production to support existing customers, but TI does not recommend using this part in a new design.

PREVIEW: Device has been announced but is not in production. Samples may or may not be available.

OBSELETE: TI has discontinued the production of the device.

(2) Eco Plan - The planned eco-friendly classification: Pb-Free (RoHS), Pb-Free (RoHS Exempt), or Green (RoHS & no Sb/Br) - please check <http://www.ti.com/productcontent> for the latest availability information and additional product content details.

TBD: The Pb-Free/Green conversion plan has not been defined.

Pb-Free (RoHS): TI's terms "Lead-Free" or "Pb-Free" mean semiconductor products that are compatible with the current RoHS requirements for all 6 substances, including the requirement that lead not exceed 0.1% by weight in homogeneous materials. Where designed to be soldered at high temperatures, TI Pb-Free products are suitable for use in specified lead-free processes.

Pb-Free (RoHS Exempt): This component has a RoHS exemption for either 1) lead-based flip-chip solder bumps used between the die and package, or 2) lead-based die adhesive used between the die and leadframe. The component is otherwise considered Pb-Free (RoHS compatible) as defined above.

Green (RoHS & no Sb/Br): TI defines "Green" to mean Pb-Free (RoHS compatible), and free of Bromine (Br) and Antimony (Sb) based flame retardants (Br or Sb do not exceed 0.1% by weight in homogeneous material)

(3) MSL, Peak Temp. - The Moisture Sensitivity Level rating according to the JEDEC industry standard classifications, and peak solder temperature.

(4) There may be additional marking, which relates to the logo, the lot trace code information, or the environmental category on the device.

(5) Multiple Device Markings will be inside parentheses. Only one Device Marking contained in parentheses and separated by a "~" will appear on a device. If a line is indented then it is a continuation of the previous line and the two combined represent the entire Device Marking for that device.

(6) Lead/Ball Finish - Orderable Devices may have multiple material finish options. Finish options are separated by a vertical ruled line. Lead/Ball Finish values may wrap to two lines if the finish value exceeds the maximum column width.

Important Information and Disclaimer:The information provided on this page represents TI's knowledge and belief as of the date that it is provided. TI bases its knowledge and belief on information provided by third parties, and makes no representation or warranty as to the accuracy of such information. Efforts are underway to better integrate information from third parties. TI has taken and continues to take reasonable steps to provide representative and accurate information but may not have conducted destructive testing or chemical analysis on incoming materials and chemicals. TI and TI suppliers consider certain information to be proprietary, and thus CAS numbers and other limited information may not be available for release.

In no event shall TI's liability arising out of such information exceed the total purchase price of the TI part(s) at issue in this document sold by TI to Customer on an annual basis.

TAPE AND REEL INFORMATION



QUADRANT ASSIGNMENTS FOR PIN 1 ORIENTATION IN TAPE



*All dimensions are nominal

Device	Package Type	Package Drawing	Pins	SPQ	Reel Diameter (mm)	Reel Width W1 (mm)	A0 (mm)	B0 (mm)	K0 (mm)	P1 (mm)	W (mm)	Pin1 Quadrant
LM48861TM/NOPB	DSBGA	YFQ	12	250	178.0	8.4	1.35	1.75	0.76	4.0	8.0	Q1

TAPE AND REEL BOX DIMENSIONS



*All dimensions are nominal

Device	Package Type	Package Drawing	Pins	SPQ	Length (mm)	Width (mm)	Height (mm)
LM48861TM/NOPB	DSBGA	YFQ	12	250	210.0	185.0	35.0

IMPORTANT NOTICE

Texas Instruments Incorporated (TI) reserves the right to make corrections, enhancements, improvements and other changes to its semiconductor products and services per JESD46, latest issue, and to discontinue any product or service per JESD48, latest issue. Buyers should obtain the latest relevant information before placing orders and should verify that such information is current and complete.

TI's published terms of sale for semiconductor products (<http://www.ti.com/sc/docs/stdterms.htm>) apply to the sale of packaged integrated circuit products that TI has qualified and released to market. Additional terms may apply to the use or sale of other types of TI products and services.

Reproduction of significant portions of TI information in TI data sheets is permissible only if reproduction is without alteration and is accompanied by all associated warranties, conditions, limitations, and notices. TI is not responsible or liable for such reproduced documentation. Information of third parties may be subject to additional restrictions. Resale of TI products or services with statements different from or beyond the parameters stated by TI for that product or service voids all express and any implied warranties for the associated TI product or service and is an unfair and deceptive business practice. TI is not responsible or liable for any such statements.

Buyers and others who are developing systems that incorporate TI products (collectively, "Designers") understand and agree that Designers remain responsible for using their independent analysis, evaluation and judgment in designing their applications and that Designers have full and exclusive responsibility to assure the safety of Designers' applications and compliance of their applications (and of all TI products used in or for Designers' applications) with all applicable regulations, laws and other applicable requirements. Designer represents that, with respect to their applications, Designer has all the necessary expertise to create and implement safeguards that (1) anticipate dangerous consequences of failures, (2) monitor failures and their consequences, and (3) lessen the likelihood of failures that might cause harm and take appropriate actions. Designer agrees that prior to using or distributing any applications that include TI products, Designer will thoroughly test such applications and the functionality of such TI products as used in such applications.

TI's provision of technical, application or other design advice, quality characterization, reliability data or other services or information, including, but not limited to, reference designs and materials relating to evaluation modules, (collectively, "TI Resources") are intended to assist designers who are developing applications that incorporate TI products; by downloading, accessing or using TI Resources in any way, Designer (individually or, if Designer is acting on behalf of a company, Designer's company) agrees to use any particular TI Resource solely for this purpose and subject to the terms of this Notice.

TI's provision of TI Resources does not expand or otherwise alter TI's applicable published warranties or warranty disclaimers for TI products, and no additional obligations or liabilities arise from TI providing such TI Resources. TI reserves the right to make corrections, enhancements, improvements and other changes to its TI Resources. TI has not conducted any testing other than that specifically described in the published documentation for a particular TI Resource.

Designer is authorized to use, copy and modify any individual TI Resource only in connection with the development of applications that include the TI product(s) identified in such TI Resource. NO OTHER LICENSE, EXPRESS OR IMPLIED, BY ESTOPPEL OR OTHERWISE TO ANY OTHER TI INTELLECTUAL PROPERTY RIGHT, AND NO LICENSE TO ANY TECHNOLOGY OR INTELLECTUAL PROPERTY RIGHT OF TI OR ANY THIRD PARTY IS GRANTED HEREIN, including but not limited to any patent right, copyright, mask work right, or other intellectual property right relating to any combination, machine, or process in which TI products or services are used. Information regarding or referencing third-party products or services does not constitute a license to use such products or services, or a warranty or endorsement thereof. Use of TI Resources may require a license from a third party under the patents or other intellectual property of the third party, or a license from TI under the patents or other intellectual property of TI.

TI RESOURCES ARE PROVIDED "AS IS" AND WITH ALL FAULTS. TI DISCLAIMS ALL OTHER WARRANTIES OR REPRESENTATIONS, EXPRESS OR IMPLIED, REGARDING RESOURCES OR USE THEREOF, INCLUDING BUT NOT LIMITED TO ACCURACY OR COMPLETENESS, TITLE, ANY EPIDEMIC FAILURE WARRANTY AND ANY IMPLIED WARRANTIES OF MERCHANTABILITY, FITNESS FOR A PARTICULAR PURPOSE, AND NON-INFRINGEMENT OF ANY THIRD PARTY INTELLECTUAL PROPERTY RIGHTS. TI SHALL NOT BE LIABLE FOR AND SHALL NOT DEFEND OR INDEMNIFY DESIGNER AGAINST ANY CLAIM, INCLUDING BUT NOT LIMITED TO ANY INFRINGEMENT CLAIM THAT RELATES TO OR IS BASED ON ANY COMBINATION OF PRODUCTS EVEN IF DESCRIBED IN TI RESOURCES OR OTHERWISE. IN NO EVENT SHALL TI BE LIABLE FOR ANY ACTUAL, DIRECT, SPECIAL, COLLATERAL, INDIRECT, PUNITIVE, INCIDENTAL, CONSEQUENTIAL OR EXEMPLARY DAMAGES IN CONNECTION WITH OR ARISING OUT OF TI RESOURCES OR USE THEREOF, AND REGARDLESS OF WHETHER TI HAS BEEN ADVISED OF THE POSSIBILITY OF SUCH DAMAGES.

Unless TI has explicitly designated an individual product as meeting the requirements of a particular industry standard (e.g., ISO/TS 16949 and ISO 26262), TI is not responsible for any failure to meet such industry standard requirements.

Where TI specifically promotes products as facilitating functional safety or as compliant with industry functional safety standards, such products are intended to help enable customers to design and create their own applications that meet applicable functional safety standards and requirements. Using products in an application does not by itself establish any safety features in the application. Designers must ensure compliance with safety-related requirements and standards applicable to their applications. Designer may not use any TI products in life-critical medical equipment unless authorized officers of the parties have executed a special contract specifically governing such use. Life-critical medical equipment is medical equipment where failure of such equipment would cause serious bodily injury or death (e.g., life support, pacemakers, defibrillators, heart pumps, neurostimulators, and implantables). Such equipment includes, without limitation, all medical devices identified by the U.S. Food and Drug Administration as Class III devices and equivalent classifications outside the U.S.

TI may expressly designate certain products as completing a particular qualification (e.g., Q100, Military Grade, or Enhanced Product). Designers agree that it has the necessary expertise to select the product with the appropriate qualification designation for their applications and that proper product selection is at Designers' own risk. Designers are solely responsible for compliance with all legal and regulatory requirements in connection with such selection.

Designer will fully indemnify TI and its representatives against any damages, costs, losses, and/or liabilities arising out of Designer's non-compliance with the terms and provisions of this Notice.

Looking for pricing, stock, or lifecycle information?

Click below to explore more details on WIN SOURCE:

 [View LM48861TM/NOPB on WIN SOURCE](#)

 [Texas Instruments](#) Information

Optimize Your Supply Chain with WIN SOURCE Solutions

-  Global Sourcing Solution
-  Obsolete Management
-  Cost Control Management
-  Shortage Management
-  Alternative Solution
-  Excess Inventory Management