



# THE DATASHEET OF CSFA105-G



## CSFA101-G Thru. CSFA105-G

Reverse Voltage: 50 to 600 Volts

Forward Current: 1.0 Amp

RoHS Device

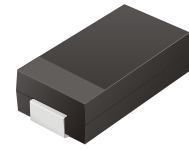

### Features

- Ideal for surface mount applications.
- Easy pick and place.
- Plastic package has Underwriters Lab. flammability classification 94V-0.
- Super fast recovery time 35nS.
- Built-in strain relief.
- Low forward voltage drop.

### Mechanical data

- Case: JEDEC DO-214AC, molded plastic.
- Terminals: solderable per MIL-STD-750, method 2026.
- Polarity: Color band denotes cathode end.
- Approx. weight: 0.063 grams

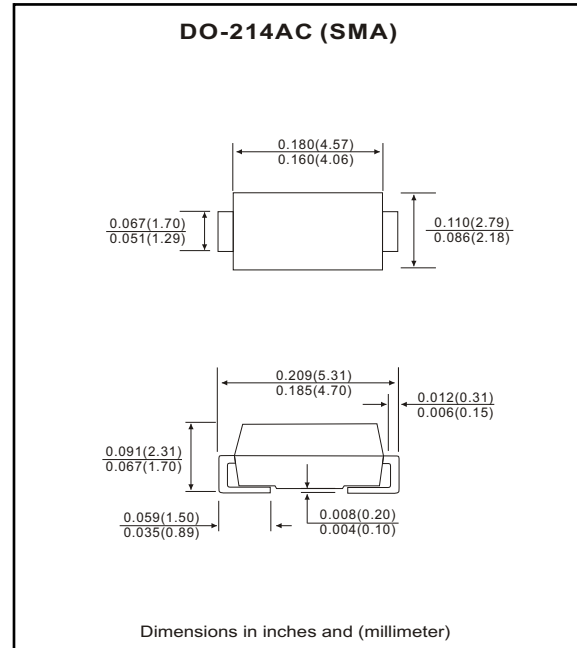

### Maximum Ratings and Electrical Characteristics

Parameter	Symbol	CSFA101-G	CSFA102-G	CSFA103-G	CSFA104-G	CSFA105-G	Units
Max. repetitive peak reverse voltage	$V_{RRM}$	50	100	200	400	600	V
Max. DC blocking voltage	$V_{DC}$	50	100	200	400	600	V
Max. RMS voltage	$V_{RMS}$	35	70	140	280	420	V
Peak surge forward current, 8.3ms single half sine-wave superimposed on rate load (JEDEC method)	$I_{FSM}$	30					A
Max. average forward current	$I_o$	1.0					A
Max. instantaneous forward voltage at 1.0A	$V_F$	0.95			1.25	1.5	V
Reverse recovery time	$T_{rr}$	35					nS
Max. DC reverse current at $T_A=25^{\circ}C$ rated DC blocking voltage $T_A=100^{\circ}C$	$I_R$				5.0	100	$\mu A$
Max. thermal resistance (Note 1)	$R_{\theta JL}$	35					$^{\circ}C/W$
Max. operating junction temperature	$T_J$	150					$^{\circ}C$
Storage temperature	$T_{STG}$	-55 to +150					$^{\circ}C$

Notes: 1. Thermal resistance from junction to lead mounted on P.C.B. with 8.0×8.0 mm<sup>2</sup> copper pad area.

## RATING AND CHARACTERISTIC CURVES (CSFA101-G thru CSFA105-G)

Fig.1 Reverse Characteristics

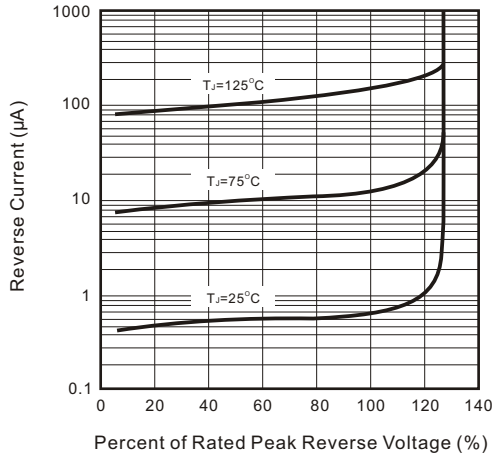

Fig.2 Forward Characteristics

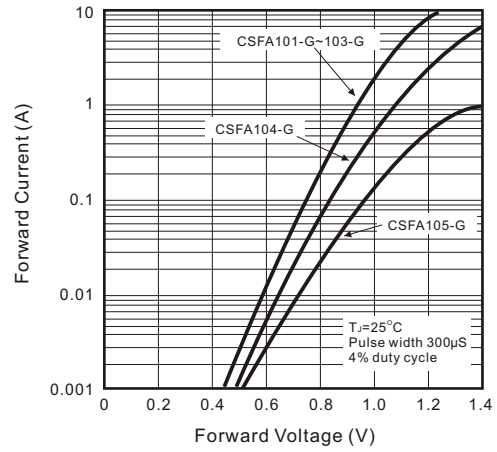

Fig.3 Junction Capacitance

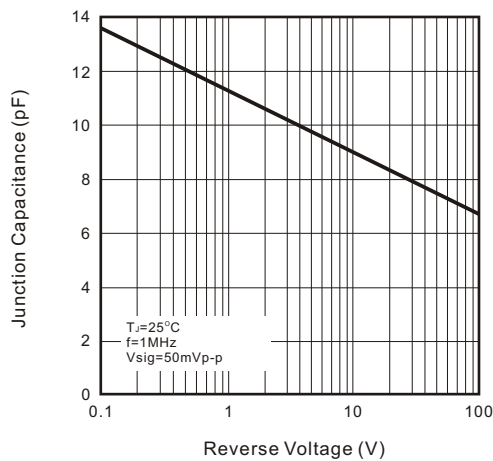

Fig.4 Non-repetitive Forward Surge Current

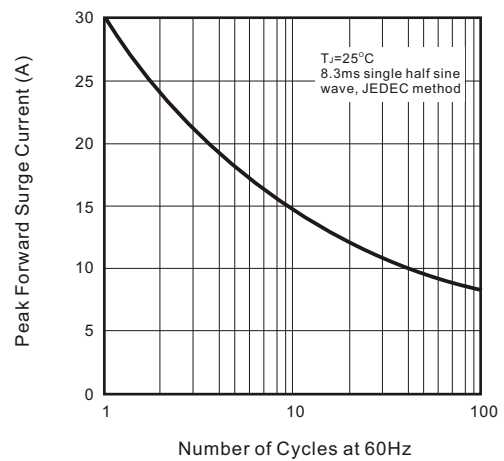

Fig.5 Test Circuit Diagram and Reverse Recovery Time Characteristics

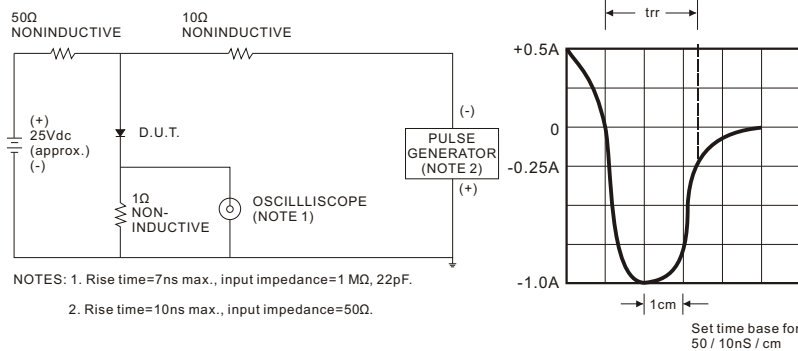
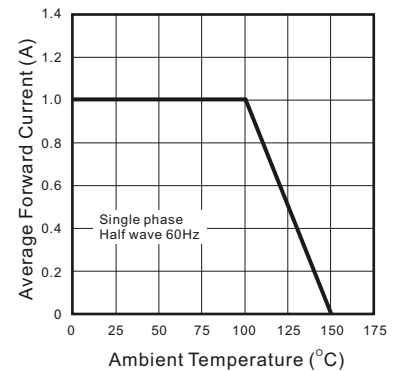

Fig.6 Current Derating Curve



## Looking for pricing, stock, or lifecycle information?

Click below to explore more details on WIN SOURCE:

- [View CSFA105-G on WIN SOURCE](#)
- [Comchip Technology Information](#)

## Optimize Your Supply Chain with WIN SOURCE Solutions

- ✓ Global Sourcing Solution
- ✓ Obsolete Management
- ✓ Cost Control Management
- ✓ Shortage Management
- ✓ Alternative Solution
- ✓ Excess Inventory Management