

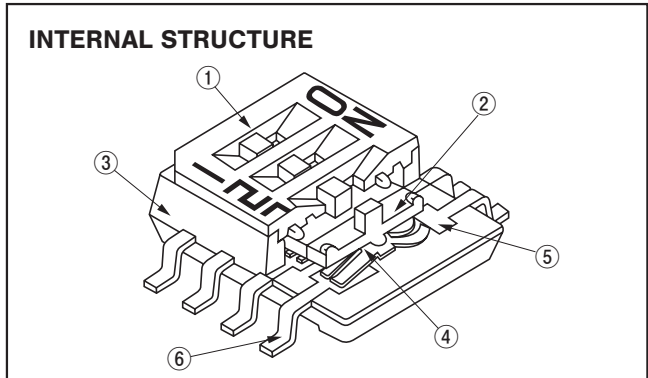

# THE DATASHEET OF CHS-01TA

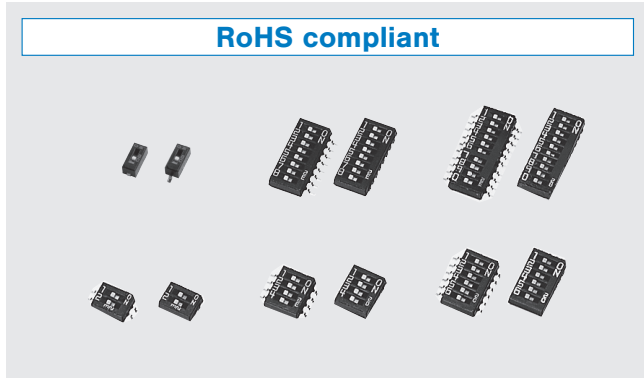

# SLIDE SWITCHES (HALF PITCH)



## FEATURES

- RoHS compliant
- Meets EIAJ SOP standard outline dimensions (B type)
- Low profile design of 2.5 mm
- 12 types of 1, 2, 4, 6, 8 or 10 bit with either gull wing or J-hook available
- Excellent contact stability by twin Gold-plated contact
- Resin material is UL Recognized 94V-0

| Part name |                | Material                  |
|-----------|----------------|---------------------------|
| ①         | Cover          | Polyphenylenesulfide      |
| ②         | Slider         | Polyamide                 |
| ③         | Housing        | Polyphenylenesulfide      |
| ④         | Slider contact | Copper alloy, Gold-plated |
| ⑤         | Fixed contact  |                           |
| ⑥         | Terminal pin   |                           |

## PART NUMBER DESIGNATION

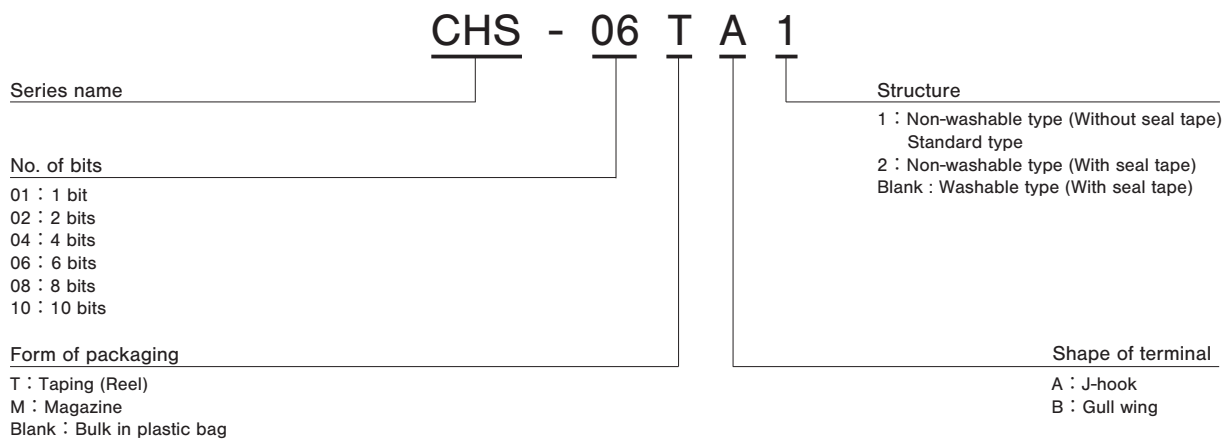

※ Please refer to the LIST OF PART NUMBERS when placing orders.

### LIST OF PART NUMBERS

| No. of bits | Form of packaging | Shape of terminals | Non-washable type (Without seal tape) |        |           |           | Non-washable type (With seal tape) |        |           |                | Packaging quantity |
|-------------|-------------------|--------------------|---------------------------------------|--------|-----------|-----------|------------------------------------|--------|-----------|----------------|--------------------|
|             |                   |                    | A                                     | J-hook | B         | Gull wing | A                                  | J-hook | B         | Gull wing      |                    |
| 1           | Taping            |                    | CHS-01TA1                             |        | CHS-01TB1 |           | CHS-01TA2                          |        | CHS-01TB2 | 1000 pcs./reel |                    |
|             | Magazine          |                    |                                       |        |           |           |                                    |        |           |                |                    |
|             | Plastic bag       |                    | CHS-01A1                              |        | CHS-01B1  |           |                                    |        |           | 50 pcs./pack   |                    |
| 2           | Taping            |                    | CHS-02TA1                             |        | CHS-02TB1 |           | CHS-02TA2                          |        | CHS-02TB2 | 500 pcs./reel  |                    |
|             | Magazine          |                    |                                       |        |           |           |                                    |        |           |                |                    |
|             | Plastic bag       |                    | CHS-02A1                              |        | CHS-02B1  |           |                                    |        |           | 50 pcs./pack   |                    |
| 4           | Taping            |                    | CHS-04TA1                             |        | CHS-04TB1 |           | CHS-04TA2                          |        | CHS-04TB2 | 500 pcs./reel  |                    |
|             | Magazine          |                    | CHS-04MA1                             |        | CHS-04MB1 |           |                                    |        |           | 70 pcs./stick  |                    |
|             | Plastic bag       |                    | CHS-04A1                              |        | CHS-04B1  |           |                                    |        |           | 50 pcs./pack   |                    |
| 6           | Taping            |                    | CHS-06TA1                             |        | CHS-06TB1 |           | CHS-06TA2                          |        | CHS-06TB2 | 500 pcs./reel  |                    |
|             | Magazine          |                    | CHS-06MA1                             |        | CHS-06MB1 |           |                                    |        |           | 50 pcs./stick  |                    |
|             | Plastic bag       |                    | CHS-06A1                              |        | CHS-06B1  |           |                                    |        |           | 50 pcs./pack   |                    |
| 8           | Taping            |                    | CHS-08TA1                             |        | CHS-08TB1 |           | CHS-08TA2                          |        | CHS-08TB2 | 500 pcs./reel  |                    |
|             | Magazine          |                    | CHS-08MA1                             |        | CHS-08MB1 |           |                                    |        |           | 40 pcs./stick  |                    |
|             | Plastic bag       |                    | CHS-08A1                              |        | CHS-08B1  |           |                                    |        |           | 50 pcs./pack   |                    |
| 10          | Taping            |                    | CHS-10TA1                             |        | CHS-10TB1 |           | CHS-10TA2                          |        | CHS-10TB2 | 500 pcs./ree   |                    |
|             | Magazine          |                    | CHS-10MA1                             |        | CHS-10MB1 |           |                                    |        |           | 30 pcs./stick  |                    |
|             | Plastic bag       |                    | CHS-10A1                              |        | CHS-10B1  |           |                                    |        |           | 50 pcs./pack   |                    |

| No. of bits | Form of packaging | Shape of terminals | Washable type (With seal tape) |        |          |                | Packaging quantity |
|-------------|-------------------|--------------------|--------------------------------|--------|----------|----------------|--------------------|
|             |                   |                    | A                              | J-hook | B        | Gull wing      |                    |
| 1           | Taping            |                    | CHS-01TA                       |        | CHS-01TB | 1000 pcs./reel |                    |
|             | Magazine          |                    |                                |        |          |                |                    |
|             | Plastic bag       |                    | CHS-01A                        |        | CHS-01B  | 50 pcs./pack   |                    |
| 2           | Taping            |                    | CHS-02TA                       |        | CHS-02TB | 500 pcs./reel  |                    |
|             | Magazine          |                    |                                |        |          |                |                    |
|             | Plastic bag       |                    | CHS-02A                        |        | CHS-02B  | 50 pcs./pack   |                    |
| 4           | Taping            |                    | CHS-04TA                       |        | CHS-04TB | 500 pcs./reel  |                    |
|             | Magazine          |                    | CHS-04MA                       |        | CHS-04MB | 70 pcs./stick  |                    |
|             | Plastic bag       |                    | CHS-04A                        |        | CHS-04B  | 50 pcs./pack   |                    |
| 6           | Taping            |                    | CHS-06TA                       |        | CHS-06TB | 500 pcs./reel  |                    |
|             | Magazine          |                    | CHS-06MA                       |        | CHS-06MB | 50 pcs./stick  |                    |
|             | Plastic bag       |                    | CHS-06A                        |        | CHS-06B  | 50 pcs./pack   |                    |
| 8           | Taping            |                    | CHS-08TA                       |        | CHS-08TB | 500 pcs./reel  |                    |
|             | Magazine          |                    | CHS-08MA                       |        | CHS-08MB | 40 pcs./stick  |                    |
|             | Plastic bag       |                    | CHS-08A                        |        | CHS-08B  | 50 pcs./pack   |                    |
| 10          | Taping            |                    | CHS-10TA                       |        | CHS-10TB | 500 pcs./ree   |                    |
|             | Magazine          |                    | CHS-10MA                       |        | CHS-10MB | 30 pcs./stick  |                    |
|             | Plastic bag       |                    | CHS-10A                        |        | CHS-10B  | 50 pcs./pack   |                    |

☐ : Not manufactured

※ Verify the above part numbers when placing orders.

Taping and magazine version can be supplied only in reel or stick units.

### STANDARD SPECIFICATIONS

|                       |   |
|-----------------------|---|
| Operating temp. range | - 40 ~ 85 °C  |
| Storage temp. range   |   |
| Sealing               | Washable type available with seal tape  |
| Net weight            | Approx. 0.05 g (CHS-01) Approx. 0.08 g (CHS-02)<br>Approx. 0.12 g (CHS-04) Approx. 0.17 g (CHS-06)<br>Approx. 0.22 g (CHS-08) Approx. 0.25 g (CHS-10) |

### ELECTRICAL CHARACTERISTICS

|   |   |
|---|---|
| Contact rating<br>Non-switching<br>Switching<br>Minimum | DC50 V, 100 mA<br>DC6 V, 100 mA DC24 V, 25 mA<br>DC20 mV 1 μA |
| Contact resistance                                      | 50 mΩ maximum   |
| Insulation resistance                                   | 1000 MΩ (DC100 V) minimum                                     |
| Dielectric strength                                     | AC500 V, 60 s   |

### MECHANICAL CHARACTERISTICS

|                   |   |
|-------------------|---|
| Operating force   | 0.5 ~ 5 N {0.05 ~ 0.51 kgf}   |
| Stop strength     | 10 N {1.02 kgf}, 60 s   |
| Solderability     | 245 ± 3 °C, 2 ~ 3 s   |
| Soldering heat    | Reflow : 255 °C (Peak temperature)<br>(Please refer to the profile below) |
|                   | Manual soldering : 350 ± 10 °C, 3 ~ 4 s                                   |
| Shear (Adhesion)  | 5 N {0.51 kgf} 10 s   |
| Substrate bending | Width 90 mm, bend 3 mm, 5 s, 1 time                                       |
| Pull-off strength | 5 N {0.51 kgf} 10 s   |

{ } : Reference only

### ENVIRONMENTAL CHARACTERISTICS

|                     |  |
|---------------------|--|
| Vibration           | (Amplitude) 1.5 mm or (Acceleration) 98 m/s <sup>2</sup> ,<br>10-500 Hz, 3 directions for 10 cycles each |
| Shock               | 490 m/s <sup>2</sup> , 11 ms<br>6 directions for 3 times each  |
| Load life           | Continuous load 2000 cycles,<br>DC6 ± 0.5 V, 100 ± 10 mA   |
| Humidity            | -10 ~ 65 °C, Relative humidity 0 ~ 96 %,<br>24 h for 10 cycles   |
| High temp. exposure | 85 °C, 96 h  |
| Low temp. exposure  | -40 °C, 96 h   |
| Thermal shock       | -40 (0.5 h) ~ 85 °C (0.5 h), 5 cycles  |

### <Reflow profile for soldering heat evaluation>

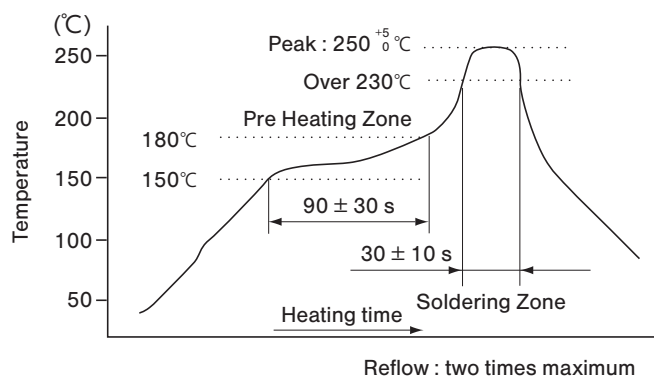

# CHS

## SLIDE SWITCHES (HALF PITCH)

### OUTLINE DIMENSIONS

Unless otherwise specified, tolerance :  $\pm 0.3$  (Unit : mm)

#### CHS-01A1 Non-washable type (Without seal tape)

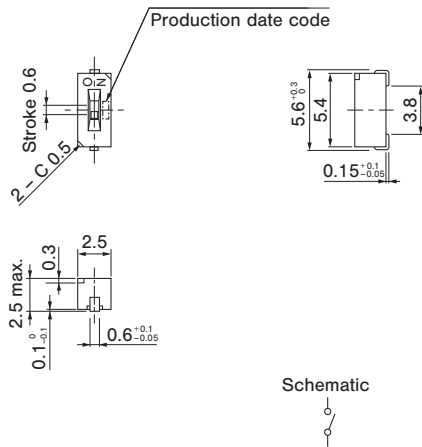

#### CHS-01B1 Non-washable type (Without seal tape)

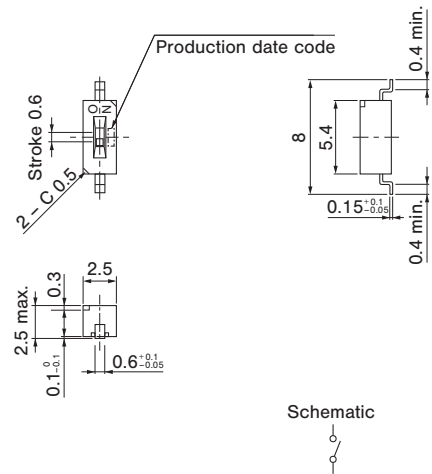

#### CHS-02A1 Non-washable type (Without seal tape)

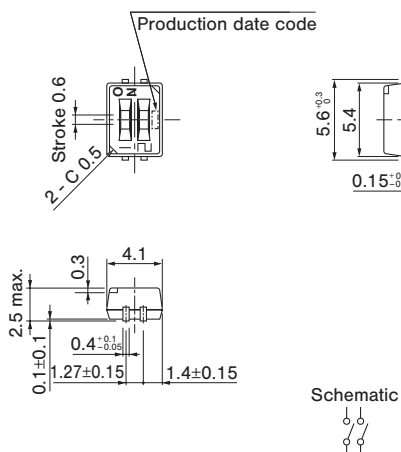

#### CHS-02B1 (In accordance with EIAJ ED-7402-1) Non-washable type (Without seal tape)

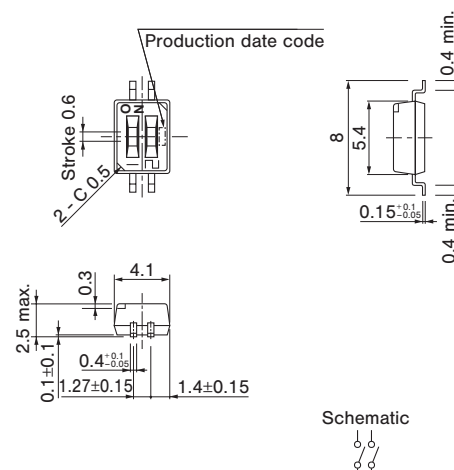

### OUTLINE DIMENSIONS

Unless otherwise specified, tolerance : ± 0.3 (Unit : mm)

● **CHS-04A1**  
**Non-washable type**  
**(Without seal tape)**

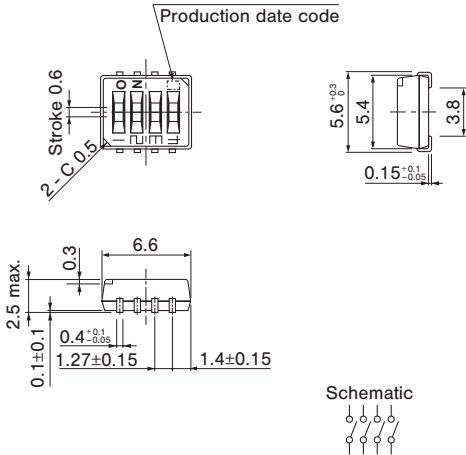

● **CHS-04B1** (In accordance with EIAJ ED-7402-1)  
**Non-washable type**  
**(Without seal tape)**

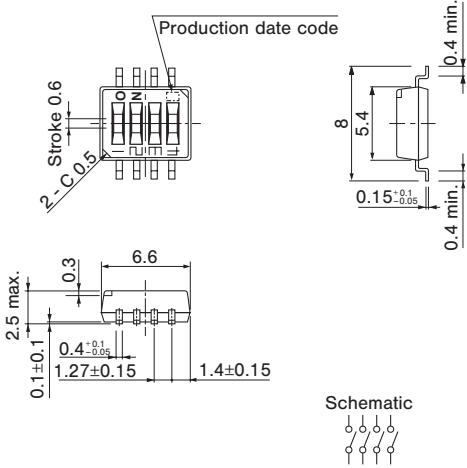

● **CHS-06A1**  
**Non-washable type**  
**(Without seal tape)**

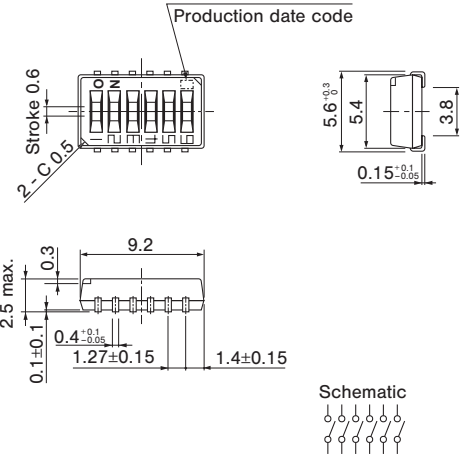

● **CHS-06B1** (In accordance with EIAJ ED-7402-1)  
**Non-washable type**  
**(Without seal tape)**

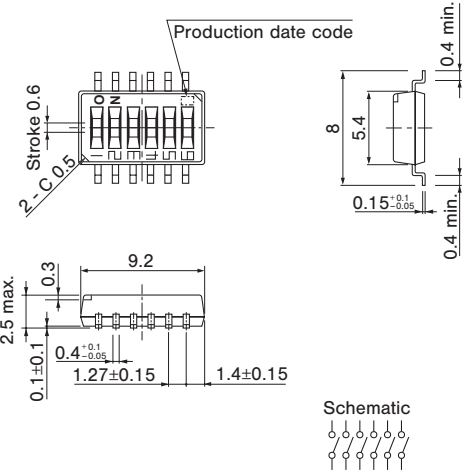

# CHS

## SLIDE SWITCHES (HALF PITCH)

### OUTLINE DIMENSIONS

Unless otherwise specified, tolerance :  $\pm 0.3$  (Unit : mm)

#### CHS-08A1 Non-washable type (Without seal tape)

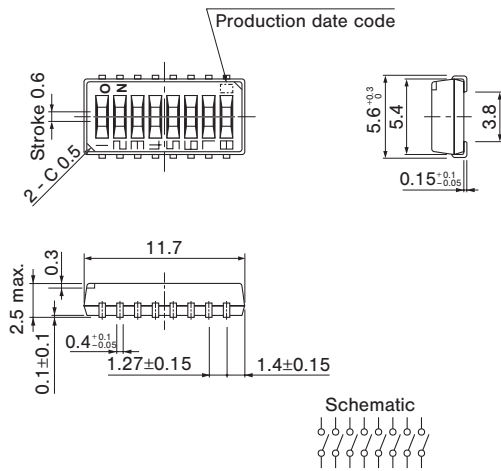

#### CHS-08B1 (In accordance with EIAJ ED-7402-1) Non-washable type (Without seal tape)

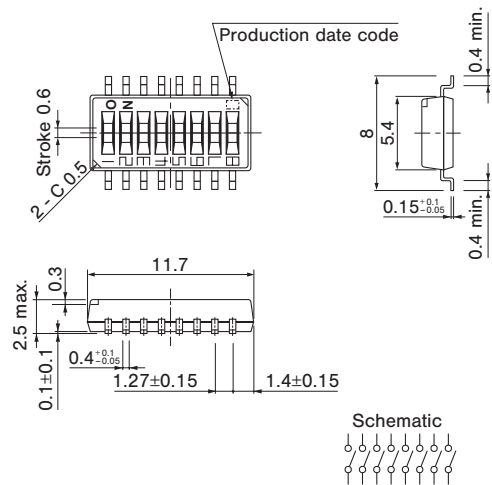

#### CHS-10A1 Non-washable type (Without seal tape)

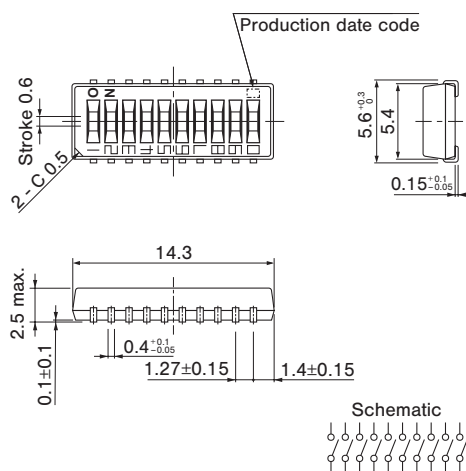

#### CHS-10B1 (In accordance with EIAJ ED-7402-1) Non-washable type (Without seal tape)

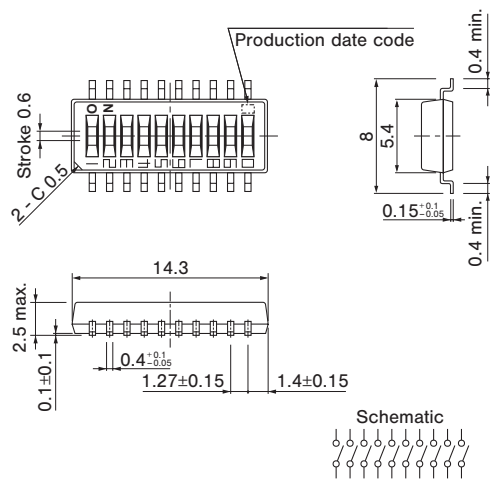

# CHS

## SLIDE SWITCHES (HALF PITCH)

### OUTLINE DIMENSIONS

Unless otherwise specified, tolerance :  $\pm 0.3$  (Unit : mm)

- **CHS-01A**  
Washable type (With seal tape)

- **CHS-01TA2**  
Non-washable type (With seal tape)

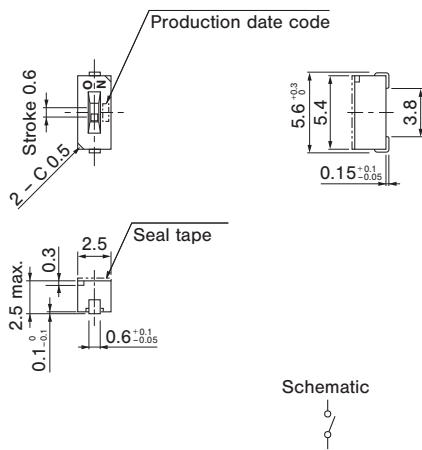

- **CHS-01B**  
Washable type (With seal tape)

- **CHS-01TB2**  
Non-washable type (With seal tape)

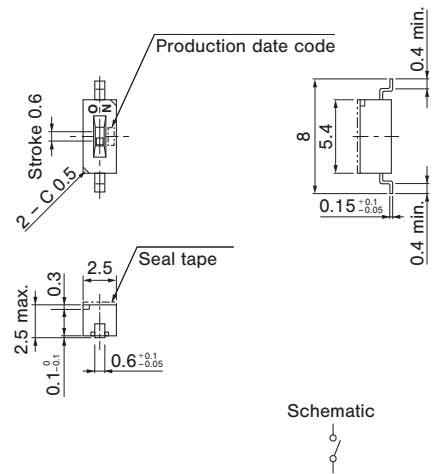

- **CHS-02A**  
Washable type (With seal tape)

- **CHS-02TA2**  
Non-washable type (With seal tape)

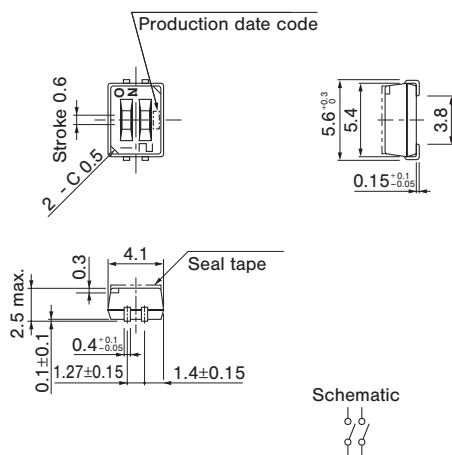

- **CHS-02B**  
Washable type (With seal tape)

- **CHS-02TB2**  
Non-washable type (With seal tape)

(In accordance with EIAJ ED-7402-1)

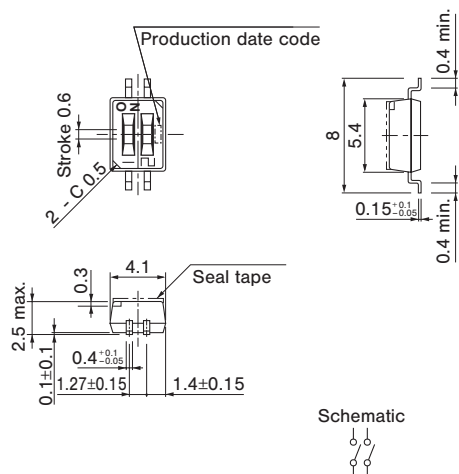

# CHS

## SLIDE SWITCHES (HALF PITCH)

### OUTLINE DIMENSIONS

Unless otherwise specified, tolerance :  $\pm 0.3$  (Unit : mm)

- **CHS-04A**  
Washable type (With seal tape)
- **CHS-04TA2**  
Non-washable type (With seal tape)

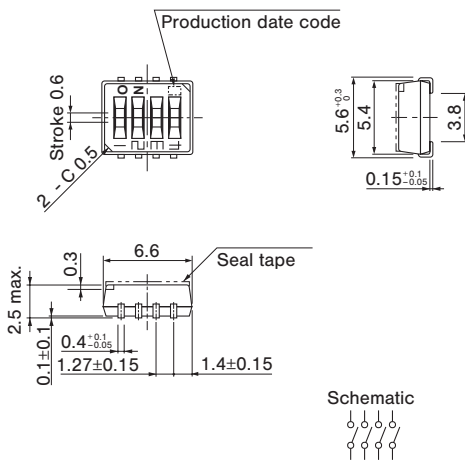

- **CHS-04B**  
Washable type (With seal tape)
- **CHS-04TB2**  
Non-washable type (With seal tape)

(In accordance with EIAJ ED-7402-1)

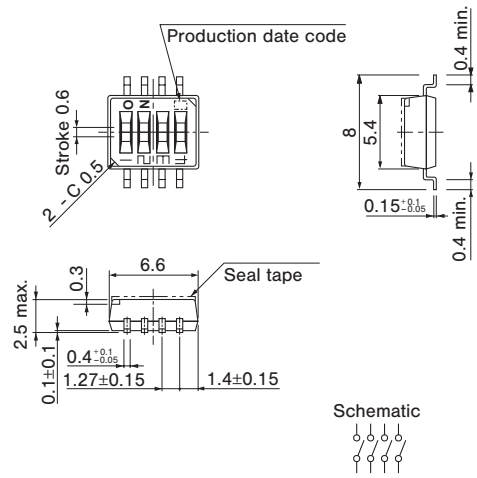

- **CHS-06A**  
Washable type (With seal tape)
- **CHS-06TA2**  
Non-washable type (With seal tape)

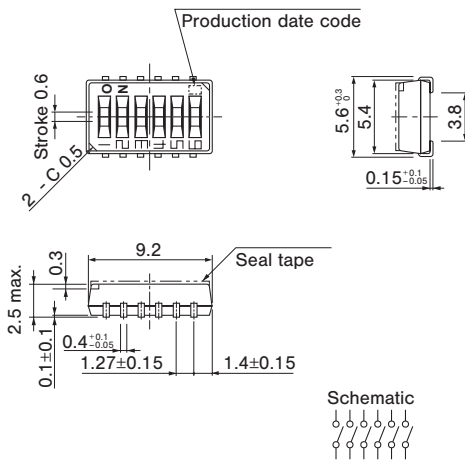

- **CHS-06B**  
Washable type (With seal tape)
- **CHS-06TB2**  
Non-washable type (With seal tape)

(In accordance with EIAJ ED-7402-1)

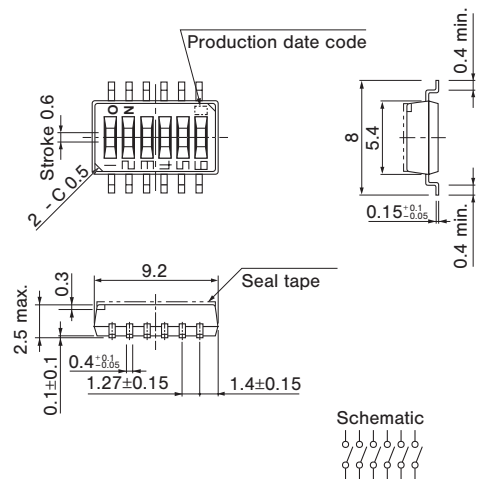

# CHS

## SLIDE SWITCHES (HALF PITCH)

### OUTLINE DIMENSIONS

Unless otherwise specified, tolerance :  $\pm 0.3$  (Unit : mm)

- **CHS-08A**  
Washable type (With seal tape)

- **CHS-08TA2**  
Non-washable type (With seal tape)

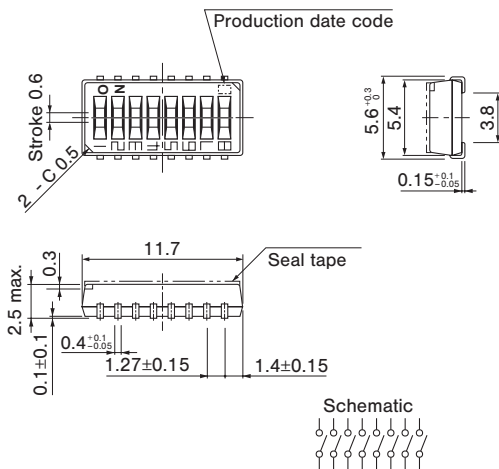

- **CHS-08B**  
Washable type (With seal tape)

- **CHS-08TB2**  
Non-washable type (With seal tape)

(In accordance with EIAJ ED-7402-1)

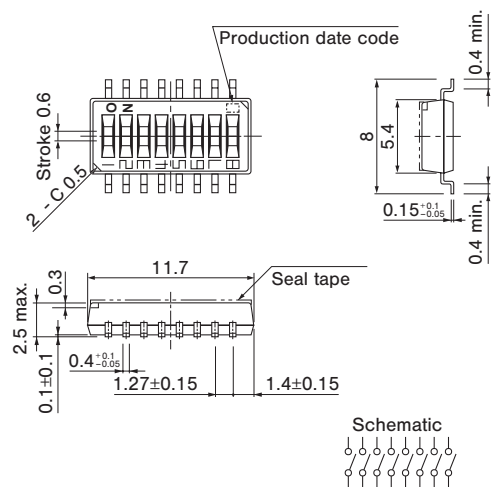

- **CHS-10A**  
Washable type (With seal tape)

- **CHS-10TA2**  
Non-washable type (With seal tape)

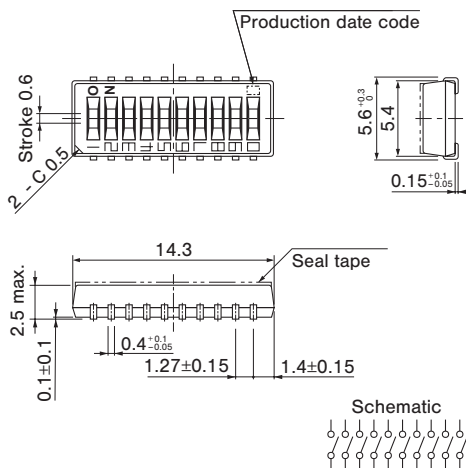

- **CHS-10B**  
Washable type (With seal tape)

- **CHS-10TB2**  
Non-washable type (With seal tape)

(In accordance with EIAJ ED-7402-1)

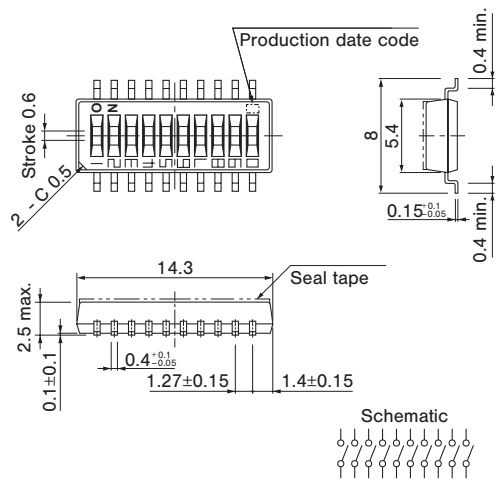

# CHS

## SLIDE SWITCHES (HALF PITCH)

### OUTLINE DIMENSIONS

Unless otherwise specified, tolerance :  $\pm 0.3$  (Unit : mm)

< Reference > The D version with opposite pin direction is available upon receipt of your order.

#### CHS-08D

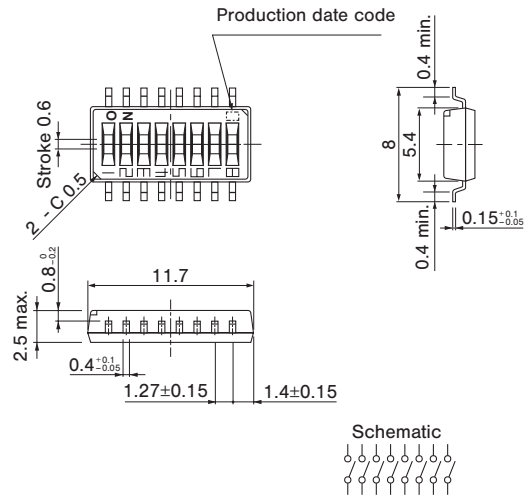
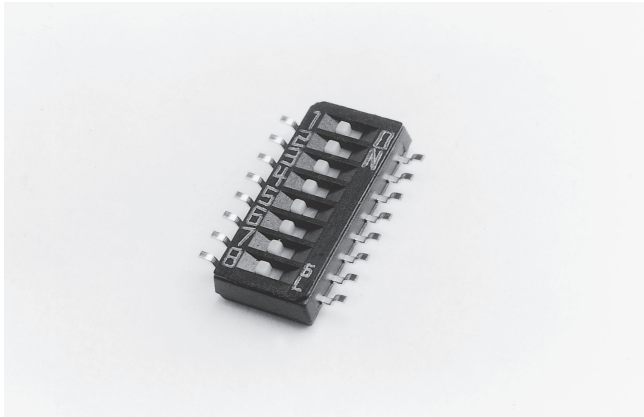

### RECOMMENDED P.C.B. PAD OUTLINE DIMENSIONS

#### 1 bit

(Unit : mm)

##### A type

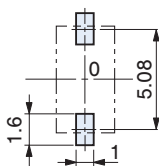

##### B type

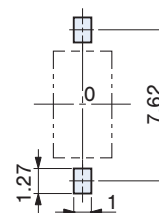

#### 2 bits

##### A type

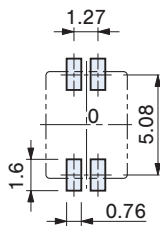

##### B type

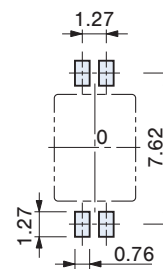

Note) The zero point is the center of mounting.

### RECOMMENDED P.C.B. PAD OUTLINE DIMENSIONS

(Unit : mm)

#### 4 bits

##### A type

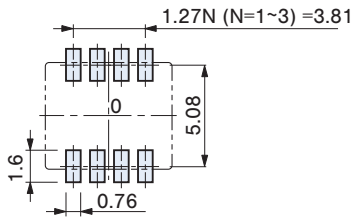

##### B type

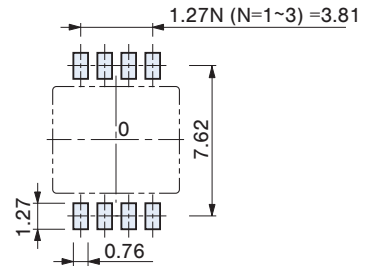

#### 6 bits

##### A type

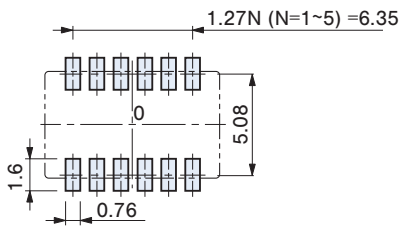

##### B type

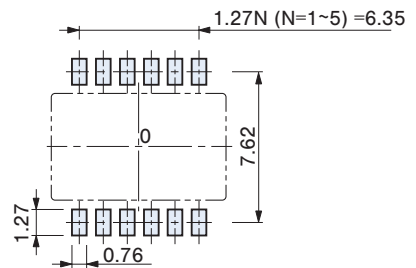

#### 8 bits

##### A type

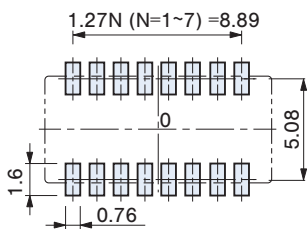

##### B type

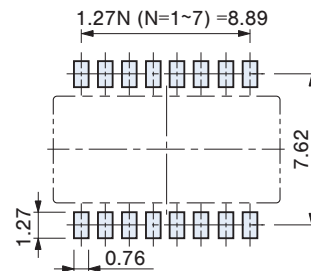

#### 10 bits

##### A type

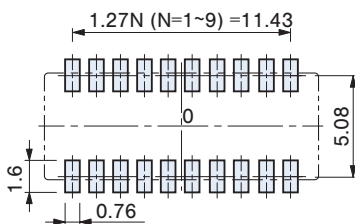

##### B type

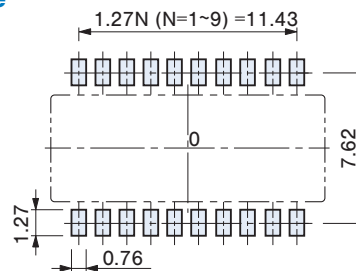

Note) The zero point is the center of mounting.

# CHS

## SLIDE SWITCHES (HALF PITCH)

### PACKAGING SPECIFICATIONS

#### <Taping packaging specifications>

- Taping version (CHS-02 ~ 10 types) are packaged in 500 pcs. per reel. Orders will be accepted for units of 500 pcs., i.e., 500, 1000, 1500 pcs., etc.  
CHS-01 type is packaged in 1000 pcs. per reel. Orders will be accepted for units of 1000 pcs., i.e., 2000, 3000 pcs., etc.
- Taping version is boxed with two reels.

Maximum number of consecutive missing pieces=2  
Leader length and reel dimension are shown in the diagrams below:

#### ● Embossed tape dimensions

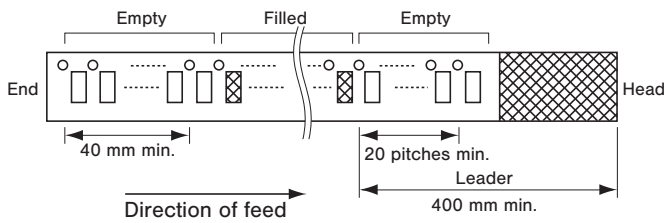

#### ● Reel dimensions

(Conforms to JIS C 0806-3)  
(In accordance with EIAJ ET-7200A)

(Unit: mm)

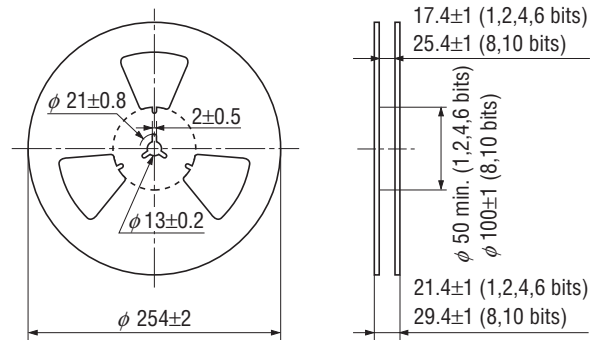

#### ● 1 bit

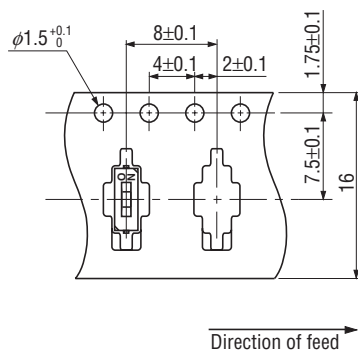

(Conforms to JIS C 0806)

(Unit : mm)

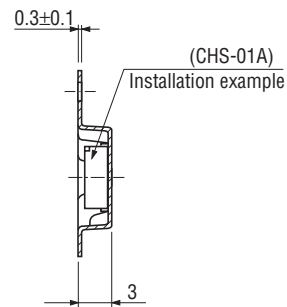

#### ● 2 bits

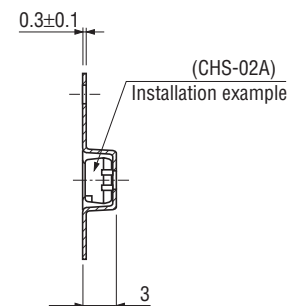
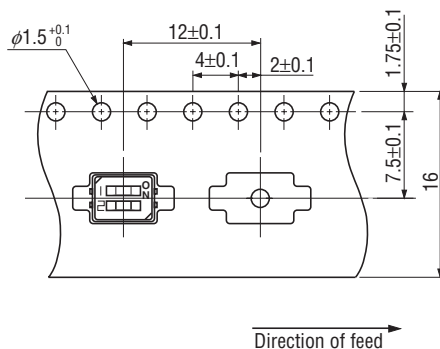

# CHS SLIDE SWITCHES (HALF PITCH)

## ● 4 bits

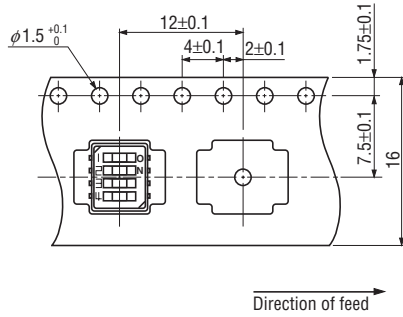

(Conforms to JIS C 0806)

(Unit : mm)

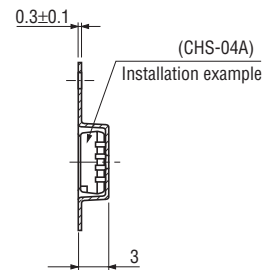

## ● 6 bits

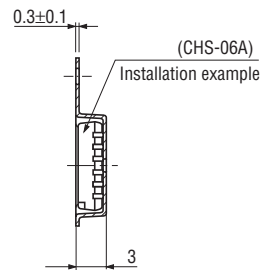
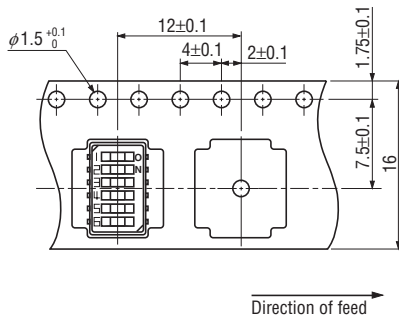

## ● 8 bits

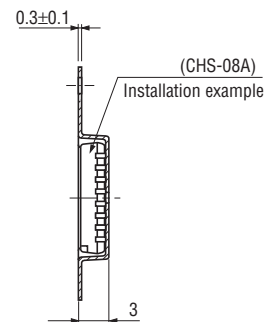
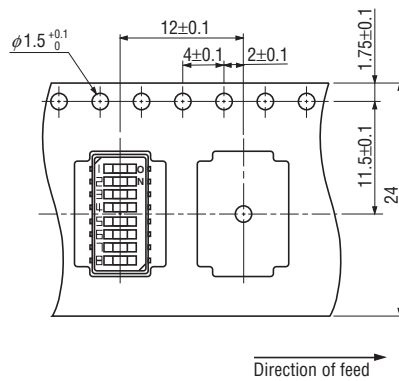

## ● 10 bits

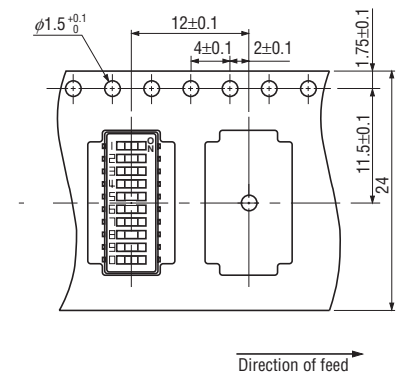

# CHS

## SLIDE SWITCHES (HALF PITCH)

---

### <Magazine packaging specifications>

- Packing quantities of magazines are different depending on the bit number of the switches.  
Please order the multiple numbers of the specific packing quantities. (e.g. 70 pcs., 140 pcs., 210 pcs., etc., in case of 4 bits version)

Pieces in package : 4 bits, 70pcs./stick  
6 bits, 50pcs./stick  
8 bits, 40pcs./stick  
10 bits, 30pcs./stick

### ● Magazine dimensions

(Unit : mm)

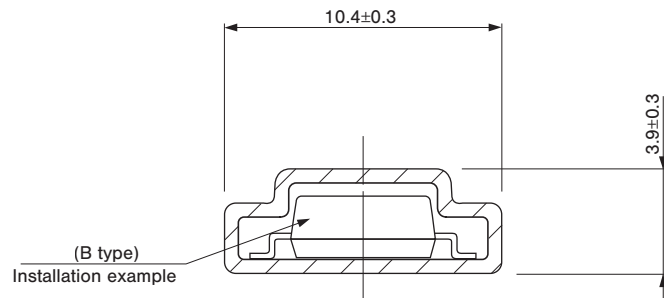



※ The magazine is common to A and B terminal pin.  
Magazine length :  $500 \pm 2$  mm long

### <Bulk pack specifications>

- The smallest unit of bulk pack in a plastic bag is 10 pcs. per pack.  
Orders will be accepted for unit of minimum 10 pcs., i.e., 10, 20, 30 pcs., etc.
- Boxing of bulk in a plastic bag is performed with 50 pcs. (standard 200 pcs.) per box.

## Looking for pricing, stock, or lifecycle information?

Click below to explore more details on WIN SOURCE:

-  [View CHS-01TA on WIN SOURCE](#)
-  [Copal Electronics Inc. Information](#)

## Optimize Your Supply Chain with WIN SOURCE Solutions

-  Global Sourcing Solution
-  Obsolete Management
-  Cost Control Management
-  Shortage Management
-  Alternative Solution
-  Excess Inventory Management