



**THE DATASHEET OF  
CDBA5819-G**



## CDBA5819-HF

Reverse Voltage: 40 Volts

Forward Current: 1A

RoHS Device

Halogen Free

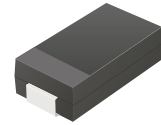

### Features

- Ideal for surface mount applications.
- Easy pick and place.
- Plastic package has Underwriters Lab. flammability classification 94V-0.
- Built-in strain relief.
- Low forward voltage drop.

### Mechanical data

- Case: JEDEC DO-214AC, molded plastic.
- Terminals: Solderable per MIL-STD-750, method 2026.
- Polarity: Color band denotes cathode end.
- Weight: 0.064 grams(Approx.).

### Circuit diagram

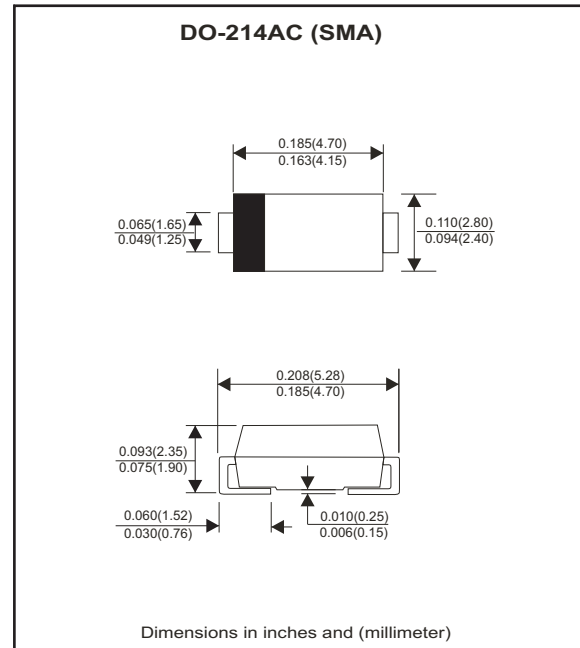

### Maximum Ratings (at TA=25°C unless otherwise noted)

Parameter	Symbol	Value	Unit
Maximum repetitive peak reverse voltage	V <sub>RRM</sub>	40	V
Maximum DC bolcking voltage	V <sub>DC</sub>	40	V
Maximum RMS voltage	V <sub>RMS</sub>	28	V
Peak surge forward current 8.3ms single half sine-wave superimposed on rate load (JEDEC method)	I <sub>FSM</sub>	20	A
Maximum Average forward current	I <sub>O</sub>	1	A
Thermal resistance from junction to ambience	R <sub>θJA</sub>	55	°C/W
Operating junction temperature range	T <sub>j</sub>	-55 to +125	°C
Storage temperature range	T <sub>STG</sub>	-55 to +125	°C

### Electrical Characteristics (at TA=25°C unless otherwise noted)

Parameter	Symbol	Value	Unit
Max. Forward voltage at 1.0 A (Note 1)	V <sub>F</sub>	0.55	V
Max. DC reverse current at rated DC blocking voltage	I <sub>R</sub>	0.5 20	mA
		T <sub>a</sub> = 25°C	
		T <sub>a</sub> = 100°C	

Note 1: Pulse test:300µs pulse width, 1% duty cycle.

## RATING AND CHARACTERISTIC CURVES (CDBA5819-HF)

Fig.1 - Typical Forward Characteristics

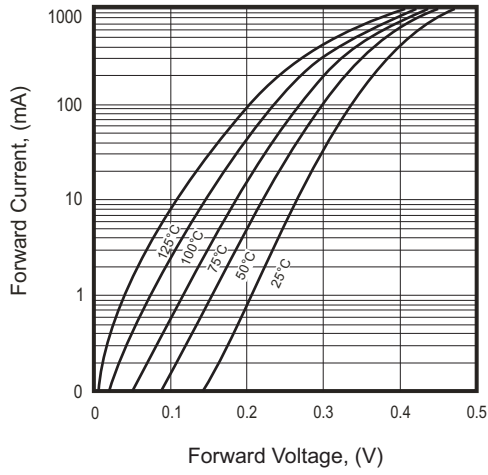

Fig.2 - Typical Reverse characteristics

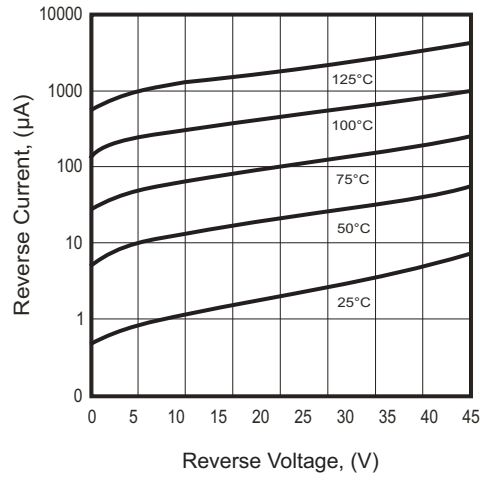

Fig.3 - Current Derating Curve

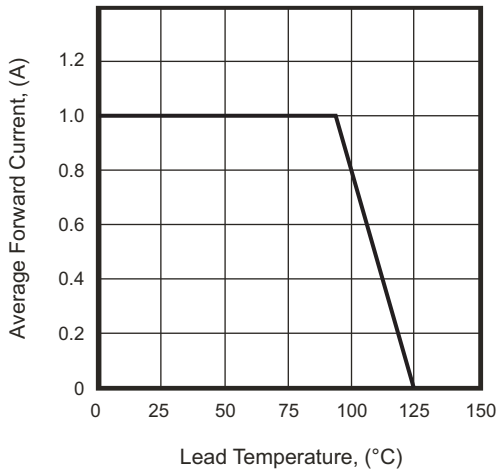
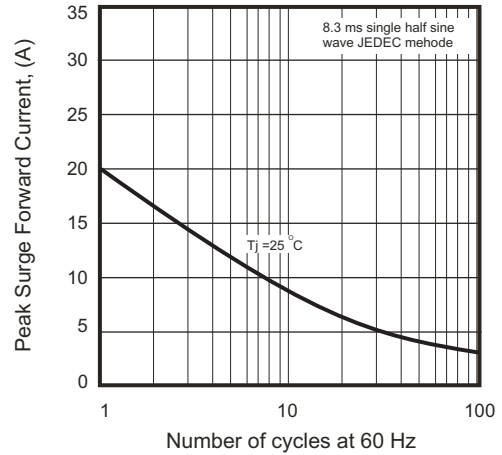
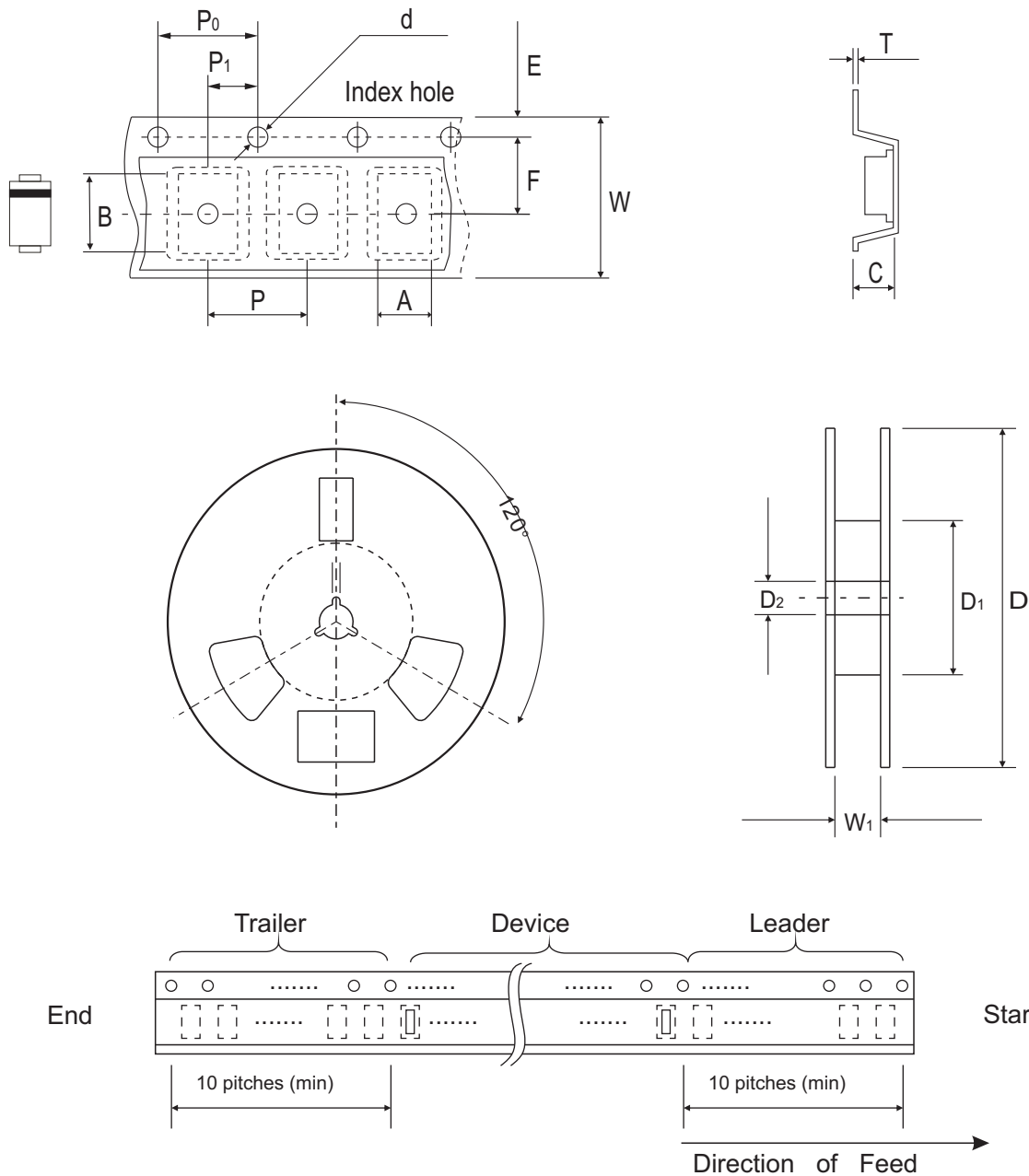

Fig.4 - Non Repetitive Peak Forward Surge Current



## Reel Taping Specification



SMA (DO-214AC)	SYMBOL	A	B	C	d	D	D1	D2
	(mm)	2.60 ± 0.15	5.18 ± 0.17	2.36 ± 0.10	1.50 ± 0.10	330 ± 1.50	75.00 ± 1.00	13.50 ± 0.50
	(inch)	0.102 ± 0.006	0.204 ± 0.007	0.093 ± 0.004	0.059 ± 0.004	12.992 ± 0.060	2.953 ± 0.040	0.531 ± 0.020

SMA (DO-214AC)	SYMBOL	E	F	P	P0	P1	W	W1
	(mm)	1.75 ± 0.10	5.50 ± 0.05	4.00 ± 0.10	4.00 ± 0.10	2.00 ± 0.05	12.00 ± 0.200	13.50 ± 0.50
	(inch)	0.069 ± 0.004	0.217 ± 0.002	0.157 ± 0.004	0.157 ± 0.004	0.079 ± 0.002	0.472 ± 0.008	0.531 ± 0.020

## Marking Code

Part Number	Marking Code
CDBA5819-HF	5819

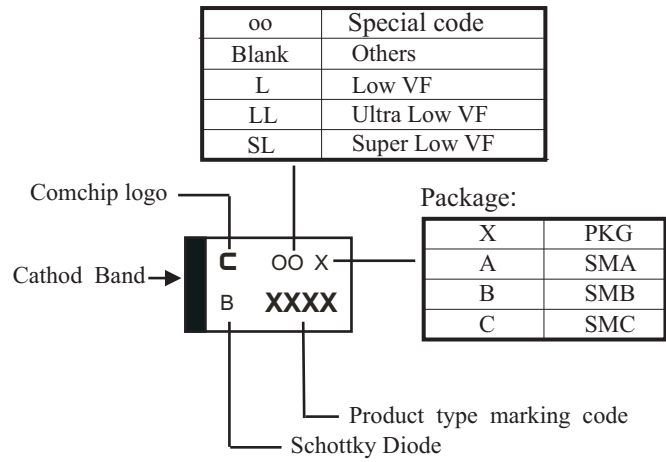

## Suggested PAD Layout

SIZE	DO-214AC (SMA)	
	(mm)	(inch)
A	4.00	0.157
B	2.50	0.098
C	1.70	0.068
D	6.50	0.256
E	1.50	0.060

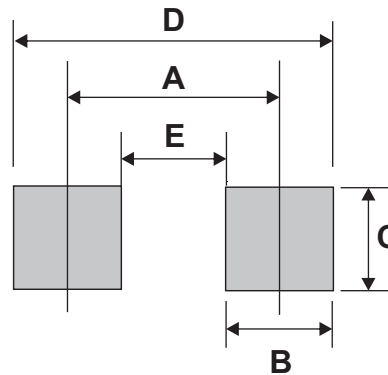



## Standard Packaging





Case Type	REEL PACK	
	REEL ( pcs )	Reel Size (inch)
DO-214AC (SMA)	5,000	13

## Looking for pricing, stock, or lifecycle information?

Click below to explore more details on WIN SOURCE:

-  [View CDBA5819-G on WIN SOURCE](#)
-  [Comchip Technology Information](#)

## Optimize Your Supply Chain with WIN SOURCE Solutions

-  Global Sourcing Solution
-  Obsolete Management
-  Cost Control Management
-  Shortage Management
-  Alternative Solution
-  Excess Inventory Management