



# THE DATASHEET OF B1100CARP



**Battrax® Series Positive/Negative - Modified DO-214**



**Description**

The Battrax® series offers programmable SIDACtor® overvoltage protection devices for SLIC applications. This series is offered in a negative Battrax version and a positive Battrax version. The B1xx0C\_ is for a  $-V_{REF}$  supply and the B2050C\_ is for a  $+V_{REF}$  supply. Designed using an SCR and a gate diode, the B1xx0C\_ Battrax begins to conduct at  $| -V_{REF} | + | -1.2 V |$  while the B2050C\_ Battrax begins to conduct at  $| +V_{REF} | + | 1.2 V |$ .

**Features and Benefits**

- Low voltage overshoot
- Low on-state voltage
- Does not degrade surge capability after multiple surge events within limit.
- Fails short circuit when surged in excess of ratings
- Robust surge current ratings
- Gate triggered tracking devices
- Pb-free E3 means 2nd level interconnect is Pb-free and the terminal finish material is tin(Sn) (IPC/JEDEC J-STD-609A.01)

**Agency Approvals**

Agency	Agency File Number
	E133083

**Pinout Designation**

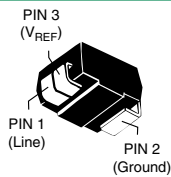

**Schematic Symbol**

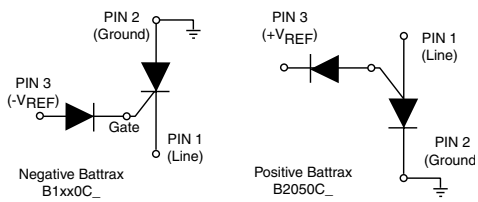

**Applicable Global Standards**

- TIA-968-A
- TIA-968-B
- ITU K.20/21 Enhanced Level\*
- ITU K.20/21 Basic Level
- GR 1089 Inter-building\*
- GR 1089 Intra-building
- IEC 61000-4-5
- YD/T 1082
- YD/T 993
- YD/T 950

\*A-rated parts require series resistance

**Electrical Characteristics**

Part Number	Marking	$V_{DRM}$	$V_S$	$I_H$	$I_S$	$I_T$	$V_T$	Capacitance*	
		@ $I_{DRM}=5\mu A$	@ $100V/\mu s$				@ $I_T=2.2 A$ mps	pF	
		V min	V max	mA min	mA max	A max	V max	Min	Max
B1100CALRP	B10A	$-V_{REF} + I + I-1.2V$	$-V_{REF} + I + I-10V$	100	100	2.2	4	30	200
B1160CALRP	B16A	$-V_{REF} + I + I-1.2V$	$-V_{REF} + I + I-10V$	160	100	2.2	4	30	200
B1200CALRP	B12A	$-V_{REF} + I + I-1.2V$	$-V_{REF} + I + I-10V$	200	100	2.2	4	30	200
B2050CALRP	B25A	$+V_{REF} + I + I1.2V$	$+V_{REF} + I + I10V$	5	50	2.2	4	20	200
B1100CCLRP	B10C	$-V_{REF} + I + I-1.2V$	$-V_{REF} + I + I-10V$	100	100	2.2	4	30	200
B1160CCLRP	B16C	$-V_{REF} + I + I-1.2V$	$-V_{REF} + I + I-10V$	160	100	2.2	4	30	200
B1200CCLRP	B12C	$-V_{REF} + I + I-1.2V$	$-V_{REF} + I + I-10V$	200	100	2.2	4	30	200
B2050CCLRP	B25C	$+V_{REF} + I + I1.2V$	$+V_{REF} + I + I10V$	5	50	2.2	4	20	200

Notes:  
 - Absolute maximum ratings measured at  $T_A = 25^\circ C$  (unless otherwise noted).  
 - Devices are uni-directional  
 - All electrical characteristics shown are defined from Tip (pin 1) to Ground (pin 2), and Ring (pin 1) to Ground (pin 2)

$-V_{REF}$  Max Value for the negative Battrax is -200 V.  
 $-V_{REF}$  Max Value for the positive Battrax is 110 V.  
 \* Off-state capacitance ( $C_o$ ) is measured across pins 1 & 2 at 1 MHz with a 2V bias.

**Surge Ratings**

Series	$I_{PP}$									$I_{TSM}$ 50/60 Hz	di/dt
	0.2x310 <sup>1</sup> 0.5x700 <sup>2</sup>	2x10 <sup>1</sup> 2x10 <sup>2</sup>	8x20 <sup>1</sup> 1.2x50 <sup>2</sup>	10x160 <sup>1</sup> 10x160 <sup>2</sup>	10x560 <sup>1</sup> 10x560 <sup>2</sup>	5x320 <sup>1</sup> 9x720 <sup>2</sup>	10x360 <sup>1</sup> 10x360 <sup>2</sup>	10x1000 <sup>1</sup> 10x1000 <sup>2</sup>	5x310 <sup>1</sup> 10x700 <sup>2</sup>		
	A min	A min	A min	A min	A min	A min	A min	A min	A min		
A	20	150	150	90	50	75	75	45	75	20	500
C	50	500	400	200	150	200	175	100	200	50	500

Notes:

- 1 Current waveform in  $\mu$ s
- 2 Voltage waveform in  $\mu$ s

- Peak pulse current rating ( $I_{PP}$ ) is repetitive and guaranteed for the life of the product that remains in thermal equilibrium.
- $I_{PP}$  ratings applicable over temperature range of -40°C to +85°C ( $I_{PP}$  rating assumes  $V_{REF}$  equals +/- 48V)
- The device must initially be in thermal equilibrium with -40°C  $\leq$   $T_J$   $\leq$  +150°C

**Thermal Considerations**

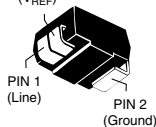
Package	Symbol	Parameter	Value	Unit
Modified DO-214AA PIN 3 ( $V_{REF}$ )  PIN 1 (Line) PIN 2 (Ground)	$T_J$	Operating Junction Temperature Range	-40 to +150	°C
	$T_S$	Storage Temperature Range	-65 to +150	°C
	$R_{\theta JA}$	Thermal Resistance: Junction to Ambient	85	°C/W

**V-I Characteristics - Negative Batrrex**

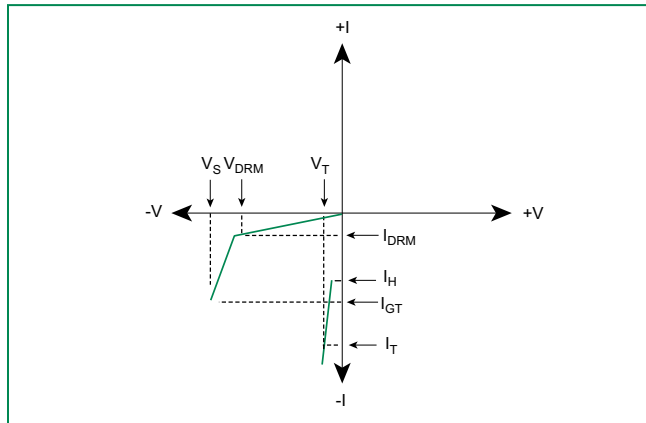

**V-I Characteristics - Positive Batrrex**

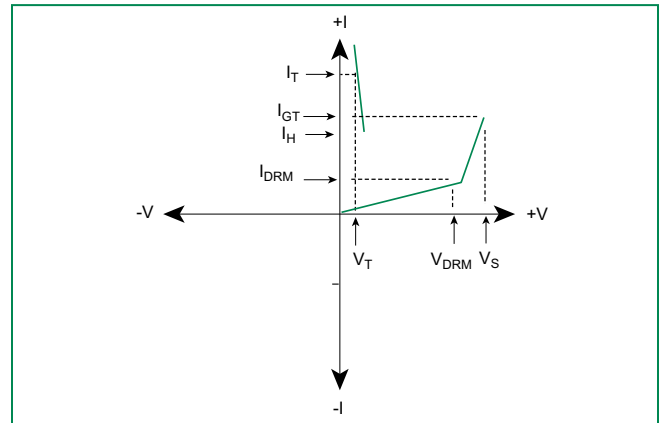

**Normalized  $V_S$  Change vs. Junction Temperature**

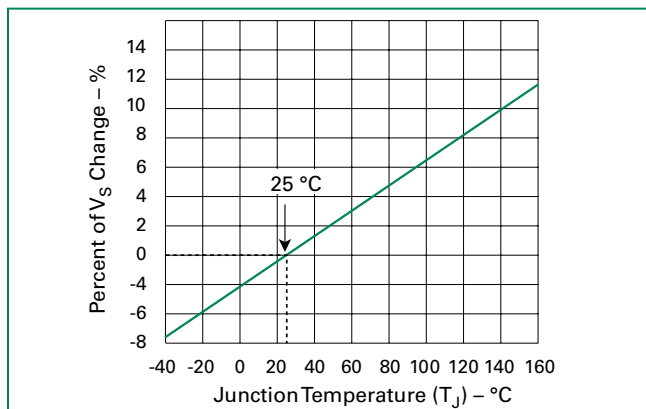

**Normalized DC Holding Current vs. Case Temperature**

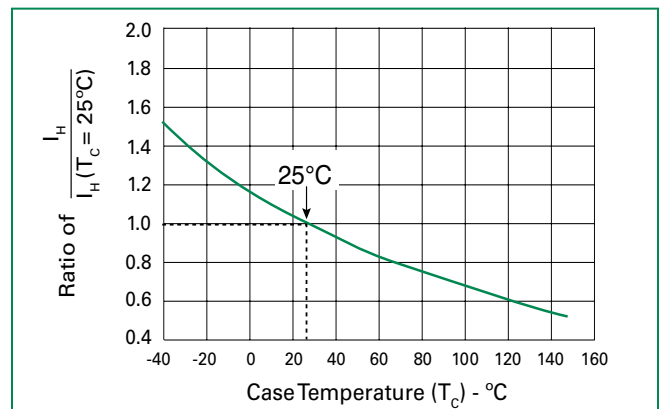

**$t_r \times t_d$  Pulse Waveform**

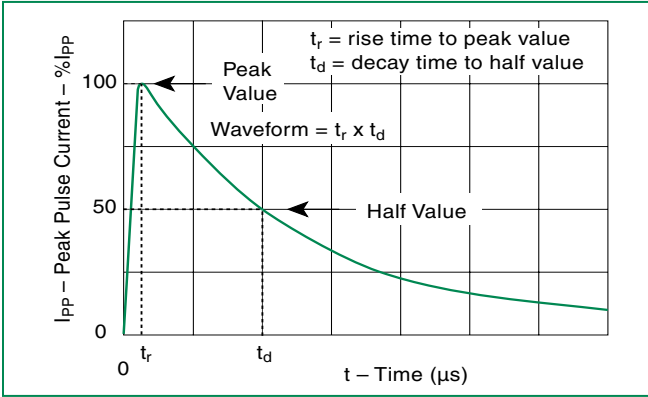

**Physical Specifications**

<b>Lead Material</b>	Copper Alloy
<b>Terminal Finish</b>	100% Matte-Tin Plated
<b>Body Material</b>	UL recognized epoxy meeting flammability classification 94V-0

**Environmental Specifications**

<b>High Temp Voltage Blocking</b>	80% Rated $V_{REF}$ Max. ( $V_{DC}$ Peak) +125°C or +150°C, 504 or 1008 hrs. MIL-STD-750 (Method 1040) JEDEC, JESD22-A-101
<b>Temp Cycling</b>	-65°C to +150°C, 15 min. dwell, 10 up to 100 cycles. MIL-STD-750 (Method 1051) EIA/JEDEC, JESD22-A-104
<b>Biased Temp &amp; Humidity</b>	52 $V_{DC}$ (+85°C) 85%RH, 504 up to 1008 hrs. EIA/JEDEC, JESD22-A-101
<b>High Temp Storage</b>	+150°C 1008 hrs. MIL-STD-750 (Method 1031) JEDEC, JESD22-A-101
<b>Low Temp Storage</b>	-65°C, 1008 hrs.
<b>Thermal Shock</b>	0°C to +100°C, 5 min. dwell, 10 sec. transfer, 10 cycles. MIL-STD-750 (Method 1056) JEDEC, JESD22-A-106
<b>Autoclave (Pressure Cooker Test)</b>	+121°C, 100%RH, 2atm, 24 up to 168 hrs. EIA/JEDEC, JESD22-A-102
<b>Resistance to Solder Heat</b>	+260°C, 30 secs. MIL-STD-750 (Method 2031)
<b>Moisture Sensitivity Level</b>	85%RH, +85°C, 168 hrs., 3 reflow cycles (+260°C Peak). JEDEC-J-STD-020, Level 1

**Soldering Parameters**

<b>Reflow Condition</b>	Pb-Free assembly (see Fig. 1)	
<b>Pre Heat</b>	-Temperature Min ( $T_{s(min)}$ )	+150°C
	-Temperature Max ( $T_{s(max)}$ )	+200°C
	-Time (Min to Max) ( $t_s$ )	60-180 secs.
<b>Average ramp up rate (Liquidus Temp (<math>T_L</math>) to peak)</b>	3°C/sec. Max.	
<b><math>T_{s(max)}</math> to <math>T_L</math> - Ramp-up Rate</b>	3°C/sec. Max.	
<b>Reflow</b>	-Temperature ( $T_L$ ) (Liquidus)	+217°C
	-Temperature ( $t_L$ )	60-150 secs.
<b>Peak Temp (<math>T_p</math>)</b>	+260(+0/-5)°C	
<b>Time within 5°C of actual Peak Temp (<math>t_p</math>)</b>	30 secs. Max.	
<b>Ramp-down Rate</b>	6°C/sec. Max.	
<b>Time 25°C to Peak Temp (<math>T_p</math>)</b>	8 min. Max.	
<b>Do not exceed</b>	+260°C	

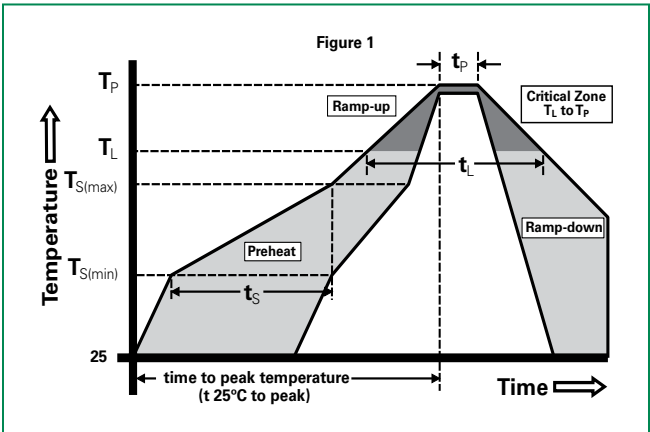

**Part Numbering**

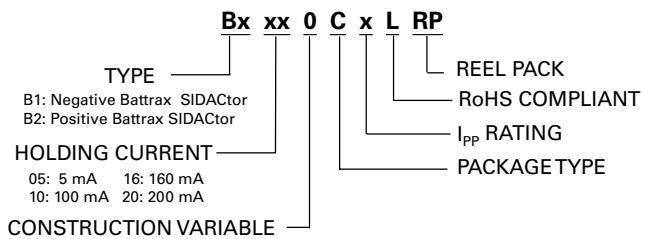

**Part Marking**

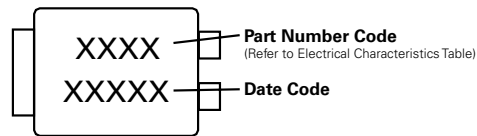

**Dimensions — Modified DO-214AA**

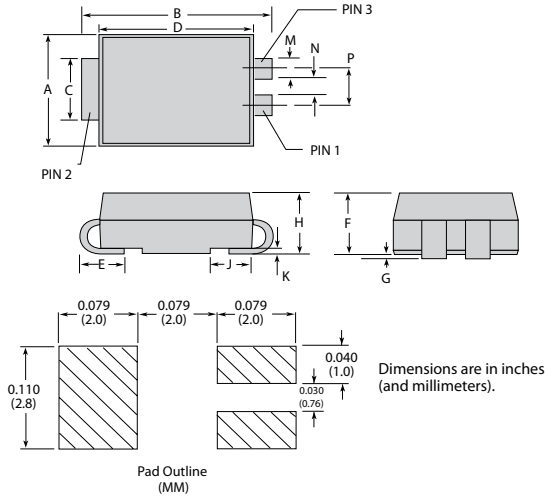

Dimensions	Inches		Millimeters	
	Min	Max	Min	Max
<b>A</b>	0.130	0.156	3.30	3.95
<b>B</b>	0.201	0.220	5.10	5.60
<b>C</b>	0.077	0.087	1.95	2.20
<b>D</b>	0.159	0.181	4.05	4.60
<b>E</b>	0.030	0.063	0.75	1.60
<b>F</b>	0.075	0.096	1.90	2.45
<b>G</b>	0.002	0.008	0.05	0.20
<b>H</b>	0.077	0.104	1.95	2.65
<b>K</b>	0.006	0.016	0.15	0.41
<b>M</b>	0.022	0.028	0.56	0.71
<b>N</b>	0.027	0.033	0.69	0.84
<b>P</b>	0.052	0.058	1.32	1.47

**Packing Options**

Package Type	Description	Quantity	Added Suffix	Industry Standard
C	Modified DO-214AA 3-leaded Tape and Reel Pack	2500	RP	EIA-481-D

**Tape and Reel Specification — Modified DO-214AA**

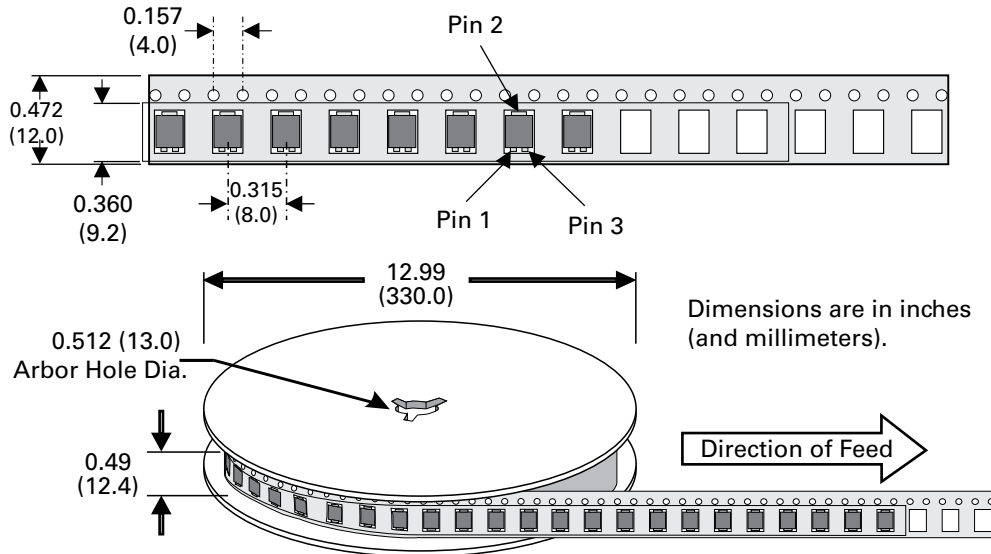

**Additional Information**



Datasheet



Resources



Samples

## Looking for pricing, stock, or lifecycle information?

Click below to explore more details on WIN SOURCE:

 [View B1100CARP on WIN SOURCE](#)

 [Littelfuse Inc. Information](#)

## Optimize Your Supply Chain with WIN SOURCE Solutions

-  Global Sourcing Solution
-  Obsolete Management
-  Cost Control Management
-  Shortage Management
-  Alternative Solution
-  Excess Inventory Management