



**THE DATASHEET OF  
ABM8W-28.3220MHZ-4-B1U-T3**



# IoT OPTIMIZED LOW PROFILE QUARTZ CRYSTAL



3.2 x 2.5 x 0.75mm

 RoHS/RoHS II Compliant

MSL = N/A: NOT APPLICABLE

## ABM8W SERIES

### FEATURES

- Optimized for energy saving wearables and IoT applications
- Plated at exceptionally low plating capacitance, as low as 4pF, with optimized ESR
- 0.75 mm max height ideally suited for height constrained designs
- Seam sealed for longterm reliability

### APPLICATIONS

- Wearables
- Internet of Things (IoT)
- Bluetooth/Bluetooth Low Energy (BLE)
- Wireless modules
- Machine-to-machine (M2M) connectivity
- Ultra-low power MCU
- Near Field Communication (NFC)
- ISM Band

### STANDARD SPECIFICATIONS

Parameters	Minimum	Typical	Maximum	Units	Notes
Frequency Range	10.0000		54.0000	MHz	
Operation Mode	Fundamental				
Operating Temperature Range	-40		+125	°C	See options
Storage Temperature	-55		+125	°C	
Frequency Tolerance @ +25°C	-10		+10	ppm	See options
Frequency Stability over the Operating Temperature ( ref. to +25°C)	-10		+10	ppm	See options
Equivalent series resistance (R1) (over -40°C to +125°C)		< 100	200	Ω	10.0000 – 11.9999MHz
		< 60	100		12.0000 – 15.9999MHz
		< 40	70		16.0000 – 19.9999MHz
		< 25	50		20.0000 – 29.9999MHz
		< 20	40		30.0000 – 39.9999MHz
		< 18	30		40.0000 – 54.0000MHz
Shunt capacitance (C0)		< 1.2	2.0	pF	
Load capacitance (CL)		4.0		pF	See options
Drive Level		10	100	μW	
Aging (1 year)	-2		+2	ppm	@ 25°C±3°C
Insulation Resistance	500			MΩ	@ 100Vdc ± 15V

# IoT OPTIMIZED LOW PROFILE QUARTZ CRYSTAL

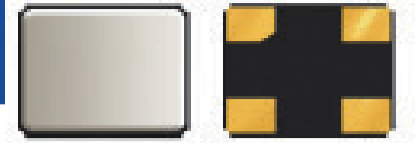

3.2 x 2.5 x 0.75mm



RoHS/RoHS II Compliant

MSL = N/A: NOT APPLICABLE

## ABM8W SERIES

### OPTIONS AND PART IDENTIFICATION (NOTE 1)

Note 1: Contact Abracon for part number requests with carrier frequency callouts up to 5&6 digit accuracy after the decimal.

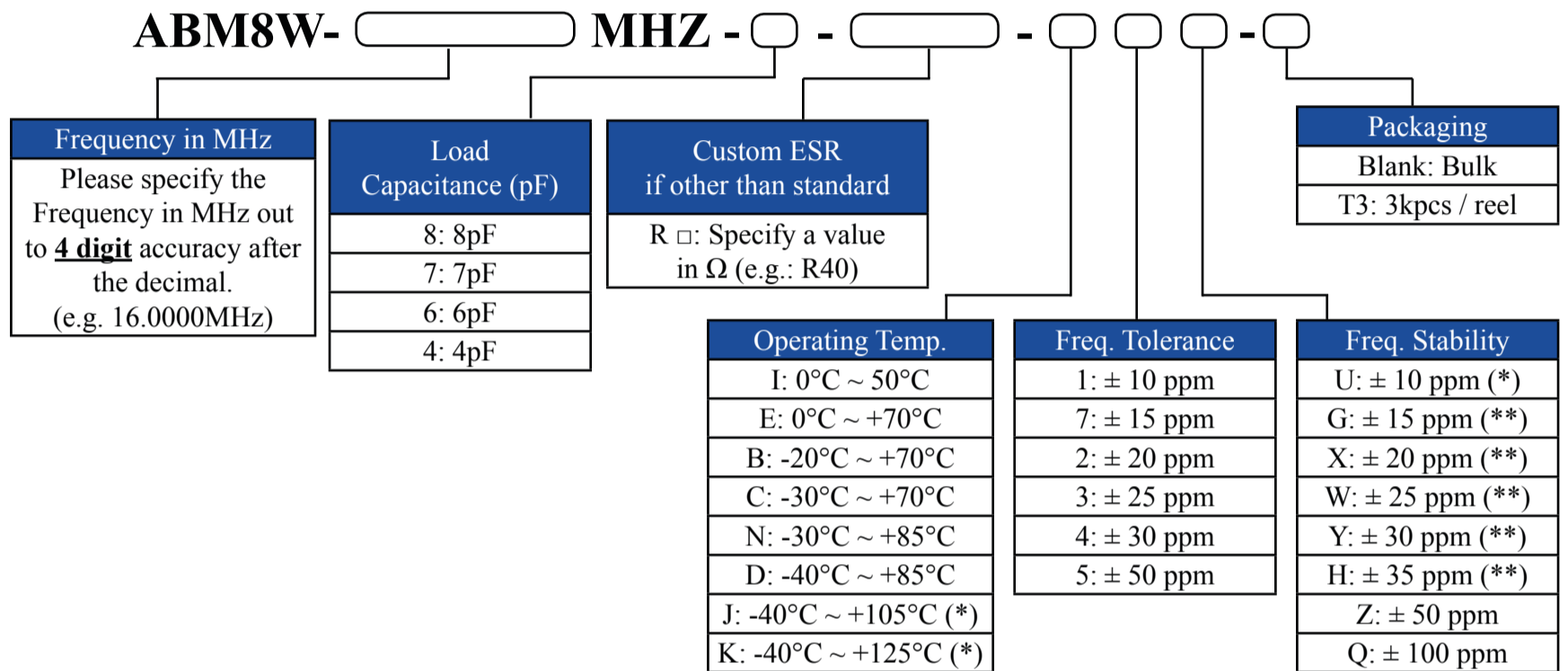

(\*) Only offered @ Freq. Stability options: Z & Q.

Contact ABRACON for tighter Frequency Stability.

(\*) Only offered @ Operating Temp. Range options: I, E, & B

(\*\*) Only offered @ Operating Temp. Range options: I, E, B, C, N, & D

Contact ABRACON for wider Operating Temp. Range.

# IoT OPTIMIZED LOW PROFILE QUARTZ CRYSTAL



3.2 x 2.5 x 0.75mm

RoHS/RoHS II Compliant

MSL = N/A: NOT APPLICABLE

## ABM8W SERIES

### TYPICAL ESR (EQUIVALENT SERIES RESISTANCE) Vs. TEMPERATURE CHARACTERISTICS

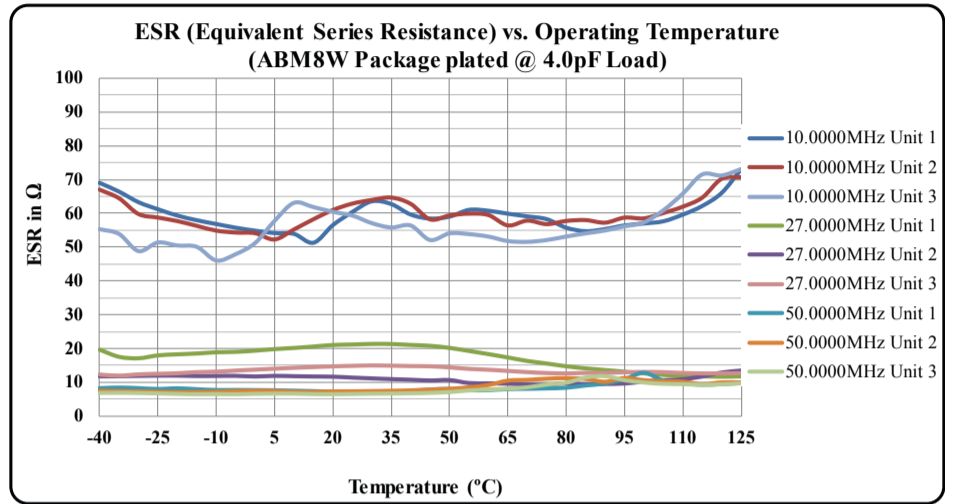
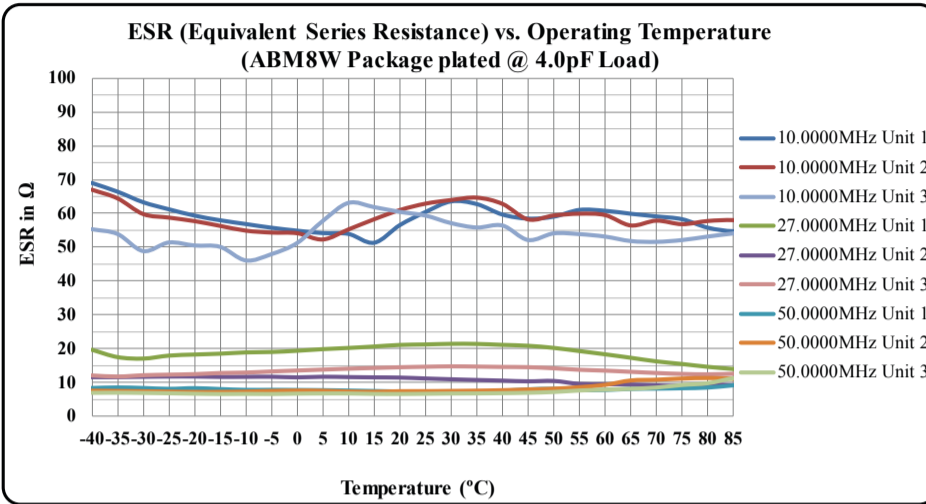

### TYPICAL FREQUENCY Vs. TEMPERATURE CHARACTERISTICS

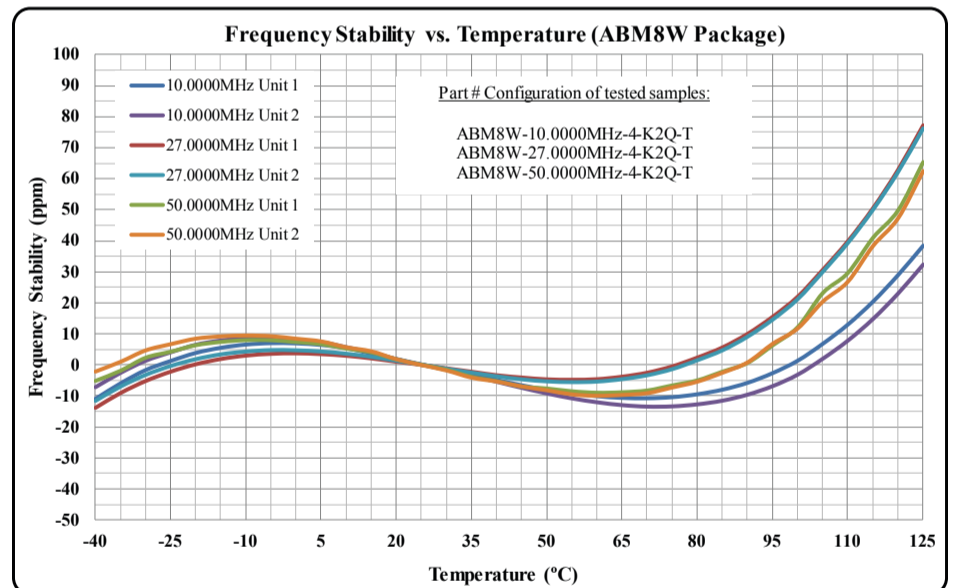
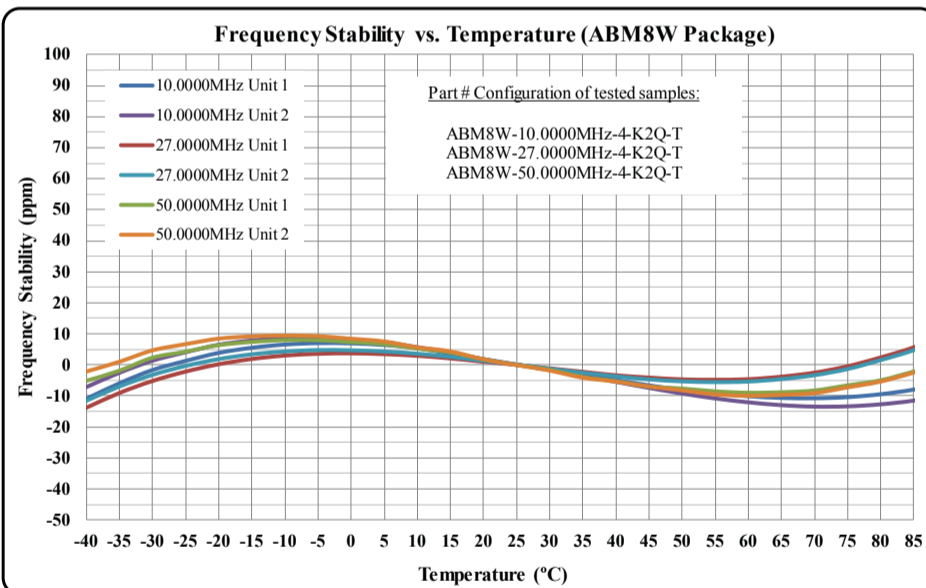

# IoT OPTIMIZED LOW PROFILE QUARTZ CRYSTAL

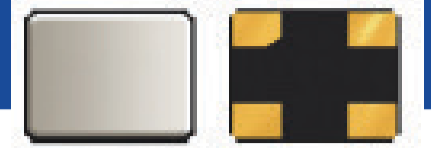

ABM8W SERIES

3.2 x 2.5 x 0.75mm



RoHS/RoHS II Compliant

MSL = N/A: NOT APPLICABLE

## TYPICAL FREQUENCY TOLERANCE DISTRIBUTION (AT 25°C ± 3°C)

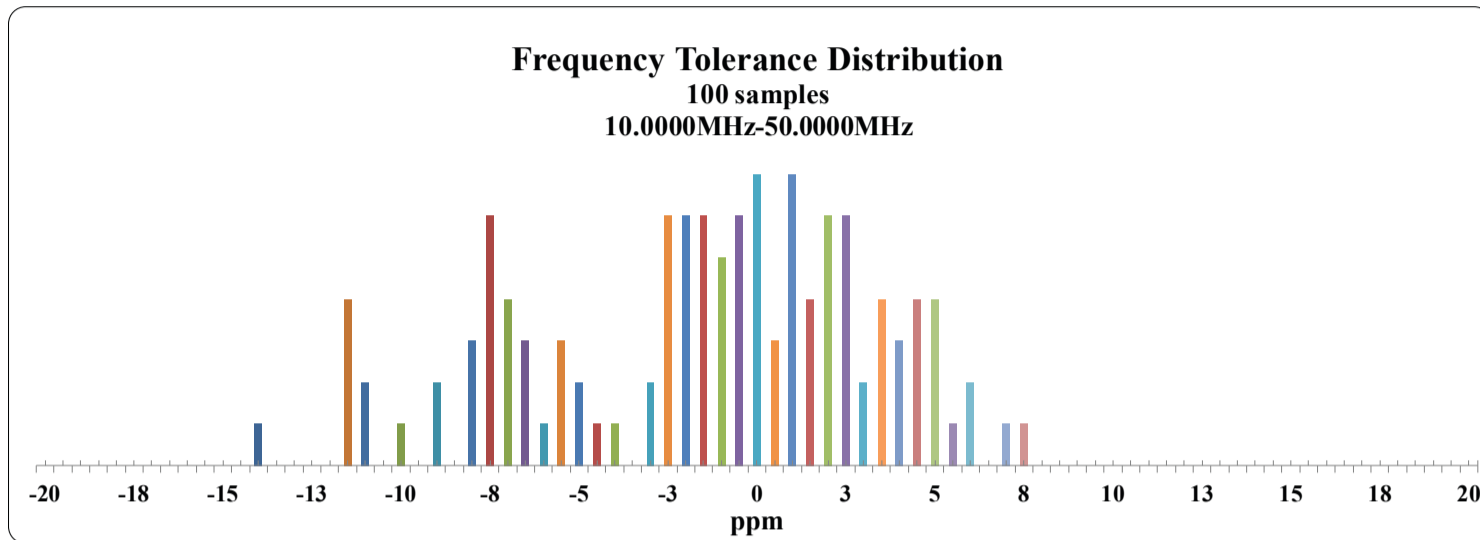

## TYPICAL ESR DISTRIBUTION (AT 25°C ± 3°C)

### ESR Distribution @ 10.0000MHz

100 samples  
MAX ESR = 77.7 Ω

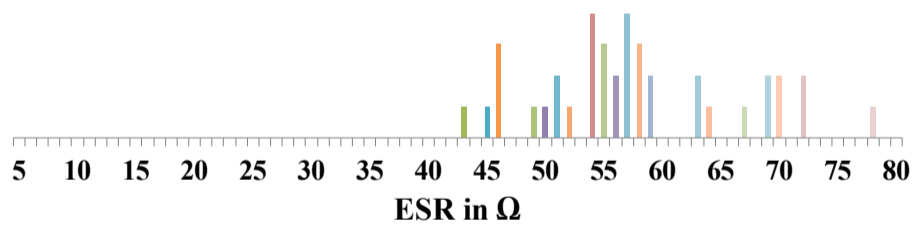

### ESR Distribution @ 27.0000MHz

100 samples  
MAX ESR = 21.6 Ω

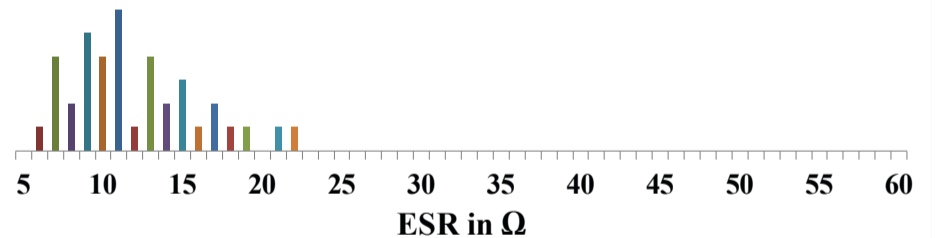

### ESR Distribution @ 50.0000MHz

100 samples  
MAX ESR = 10.23 Ω

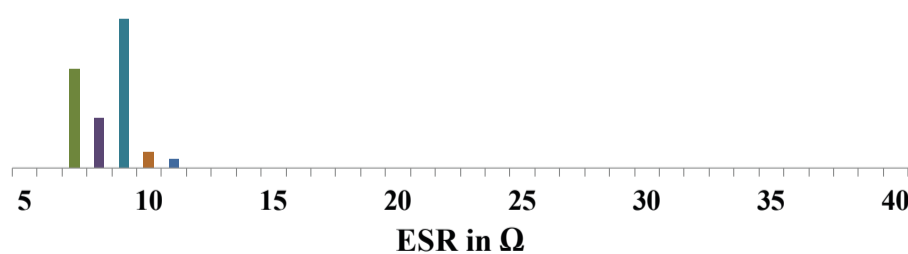

# IoT OPTIMIZED LOW PROFILE QUARTZ CRYSTAL



ABM8W SERIES

3.2 x 2.5 x 0.75mm



RoHS/RoHS II Compliant

MSL = N/A: NOT APPLICABLE

## SPICE MODELS (BASED ON TYPICAL VALUES AT 25°C ± 3°C)

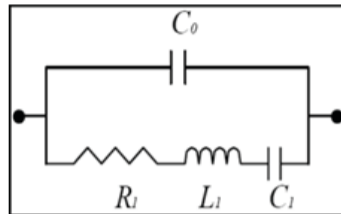

<b>Frequency: 10.0000MHz</b> <b>Plating Load: 4pF</b>			<b>Frequency: 10.0000MHz</b> <b>Plating Load: 6pF</b>		
C0	=	0.88 pF	C0	=	0.86 pF
R1	=	53.82 Ω	R1	=	60.62 Ω
L1	=	162.02 mH	L1	=	164.96 mH
C1	=	1.56 fF	C1	=	1.54 fF
<b>Frequency: 27.0000MHz</b> <b>Plating Load: 4pF</b>			<b>Frequency: 27.0000MHz</b> <b>Plating Load: 6pF</b>		
C0	=	1.16 pF	C0	=	1.16 pF
R1	=	11.83 Ω	R1	=	11.06 Ω
L1	=	9.16 mH	L1	=	9.10 mH
C1	=	3.80 fF	C1	=	3.82 fF
<b>Frequency: 50.0000MHz</b> <b>Plating Load: 4pF</b>			<b>Frequency: 50.0000MHz</b> <b>Plating Load: 6pF</b>		
C0	=	1.16 pF	C0	=	1.15 pF
R1	=	7.61 Ω	R1	=	8.06 Ω
L1	=	2.45 mH	L1	=	2.49 mH
C1	=	4.14 fF	C1	=	4.07 fF

## MECHANICAL DIMENSIONS

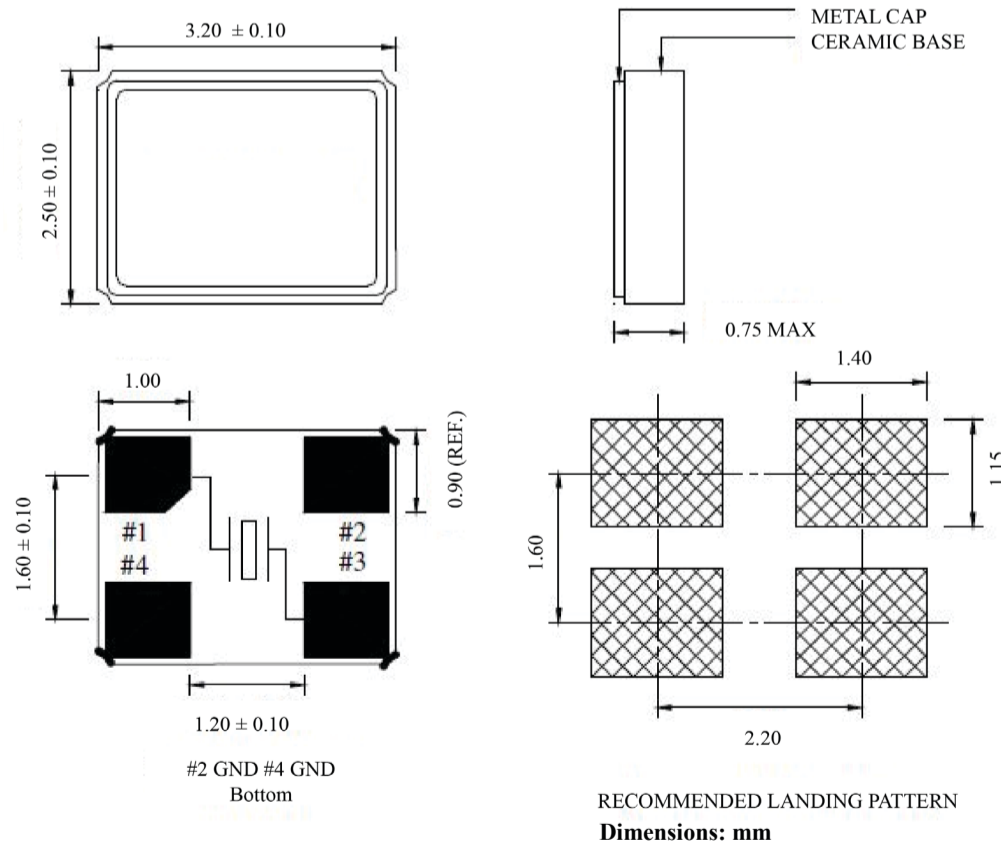

### Note:

Due to material availability the Chamfer could be located on pin #1, 2 or 4. Be advised that the Chamfer location has no impact on the electrical performance of the device.

# IoT OPTIMIZED LOW PROFILE QUARTZ CRYSTAL

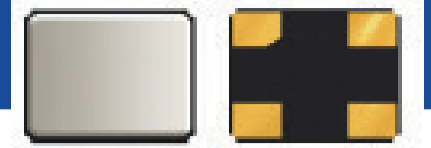

ABM8W SERIES

3.2 x 2.5 x 0.75mm



RoHS/RoHS II Compliant

MSL = N/A: NOT APPLICABLE

## REFLOW PROFILE

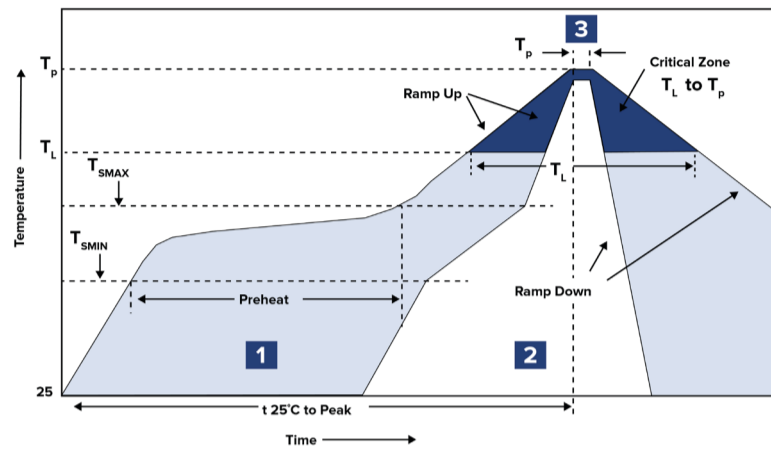

Zone	Description	Temperature	Time
1	Preheat	$T_{SMIN} \sim T_{SMAX}$ 150°C ~ 180°C	60 ~ 120 sec.
2	Reflow	$T_L$ 217°C	45 ~ 90 sec.
3	Peak Heat	$T_P$ 260°C MAX	10 sec.

## PACKAGING

T3: Tape and reel (3,000 pcs/reel)

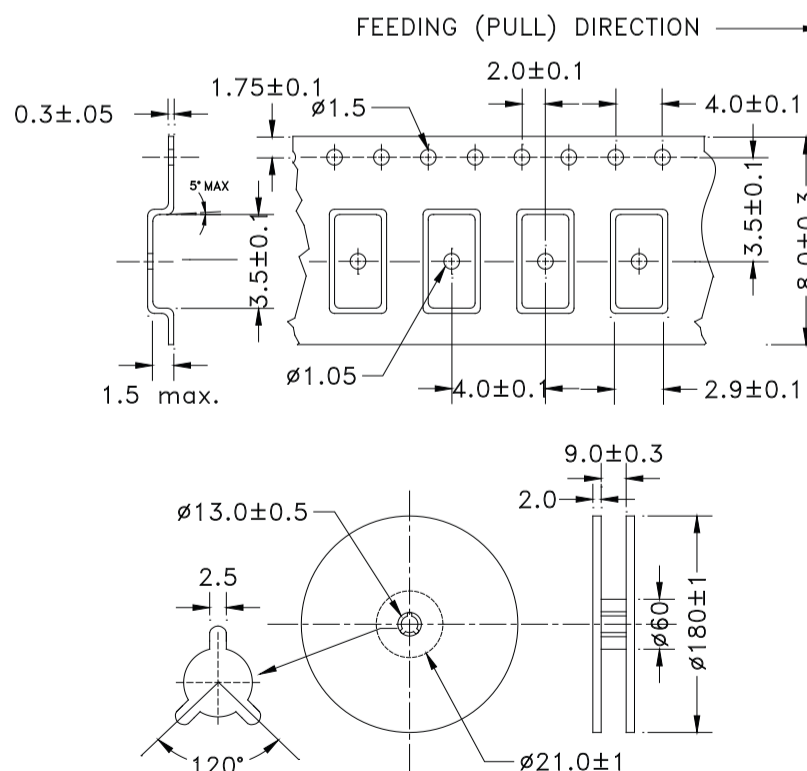

DIMENSIONS: mm

## Looking for pricing, stock, or lifecycle information?

Click below to explore more details on WIN SOURCE:

- [View ABM8W-28.3220MHZ-4-B1U-T3 on WIN SOURCE](#)
- [Abracon LLC Information](#)

## Optimize Your Supply Chain with WIN SOURCE Solutions

- ✓ Global Sourcing Solution
- ✓ Obsolete Management
- ✓ Cost Control Management
- ✓ Shortage Management
- ✓ Alternative Solution
- ✓ Excess Inventory Management