

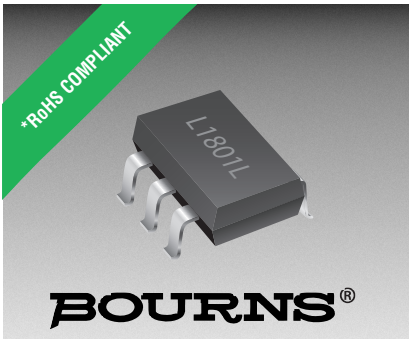

**THE DATASHEET OF
CDSOT236-T24C**





Features

- Lead free device
- RoHS compliant*
- Unidirectional and bidirectional configurations
- Protects 4 or 5 lines
- ESD, EFT and surge protection

Applications

- Cell phones
- PDAs and notebooks
- Digital cameras
- GPS
- MP3 players

CDSOT236-T05~T24C Series - TVS Diode Arrays

General Information

Portable communications, computing and video equipment manufacturers are challenging the semiconductor industry to develop increasingly smaller electronic components.

Bourns offers Transient Voltage Suppressor Array diodes for ESD, EFT and surge protection applications, in SOT23-6 package size format. The Transient Voltage Suppressor Array series offers a choice of voltage types ranging from 5 V to 24 V in a bidirectional configuration. Bourns® Chip Diodes conform to JEDEC standards, are easy to handle on standard pick and place equipment and their flat configuration minimizes roll away.

The Bourns® device will meet IEC 61000-4-2 (ESD), IEC 61000-4-4 (EFT) and IEC 61000-4-5 (Surge) requirements.

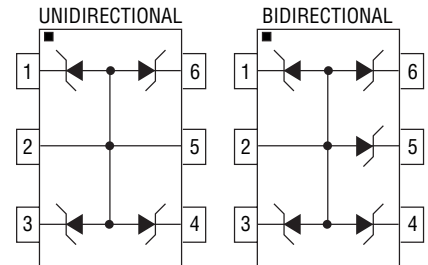

Electrical & Thermal Characteristics (@ T_A = 25 °C Unless Otherwise Noted)

Parameter	Symbol	Value	Unit
Peak Pulse Power (t _p = 8/20 μs) ¹	P _{PP}	350	W
Operating Temperature	T _J	-55 to +150	°C
Storage Temperature	T _{STG}	-55 to +150	°C

Parameter	Symbol	CDSOT236-								Unit
		Uni-T05	Bi-T05C	Uni-T12	Bi-T12C	Uni-T15	Bi-T15C	Uni-T24	Bi-T24C	
Min. Breakdown Voltage @ 1 mA	V _{BR}	6.0	6.0	13.3	13.3	16.7	16.7	26.7	26.7	V
Working Peak Voltage	V _{WM}	5.0	5.0	12.0	12.0	15.0	15.0	24.0	24.0	V
Max. Clamping Voltage @ I _P = 1 A	V _C	9.8	9.8	19.0	19.0	24.0	24.0	43.0	43.0	V
Max. Clamping Voltage @ 8/20 μs @ I _{PP}	V _C	21.0 V @ 17 A	21.0 V @ 17 A	29.2 V @ 12 A	29.2 V @ 12 A	34.6 V @ 10 A	34.6 V @ 10 A	58.3 V @ 6 A	58.3 V @ 6 A	V
Max. Leakage Current @ V _{WM}	I _D	20	20	1	1	1	1	1	1	μA
Typ. Capacitance @ 0 V, 1 MHz	C _J	150	150	80	80	50	50	40	40	pF

Notes:

1. See Peak Pulse Power vs. Pulse Time.

BOURNS®

Asia-Pacific: Tel: +886-2 2562-4117 • Email: asiacus@bourns.com

EMEA: Tel: +36 88 520 390 • Email: eurocus@bourns.com

The Americas: Tel: +1-951 781-5500 • Email: americus@bourns.com

www.bourns.com

*RoHS Directive 2002/95/EC Jan. 27, 2003 including annex and RoHS Recast 2011/65/EU June 8, 2011.

Specifications are subject to change without notice.

Specifications are subject to change without notice.

The device characteristics and parameters in this data sheet can and do vary in different applications and actual device performance may vary over time.

Users should verify actual device performance in their specific applications.

CDSOT236-T05~T24C Series - TVS Diode Arrays



Mechanical Characteristics

This is a molded JEDEC SOT23-6 package with lead free 100 % Tin (Sn) on the lead frame. It weighs approximately 15 mg and has a flammability rating of UL 94V-0.

Product Dimensions

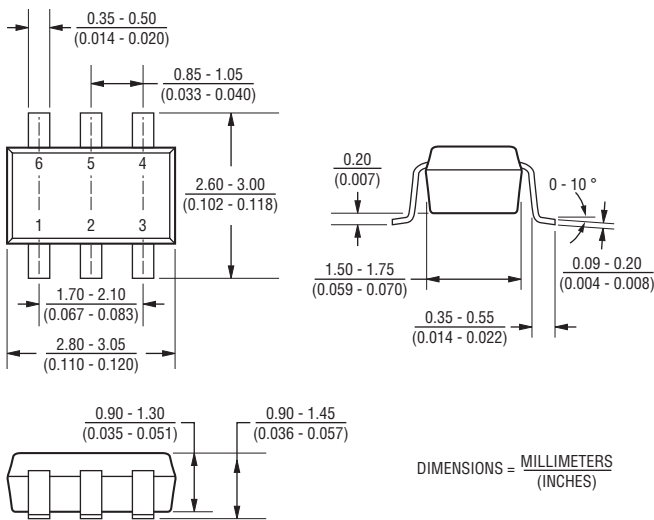

Recommended Footprint

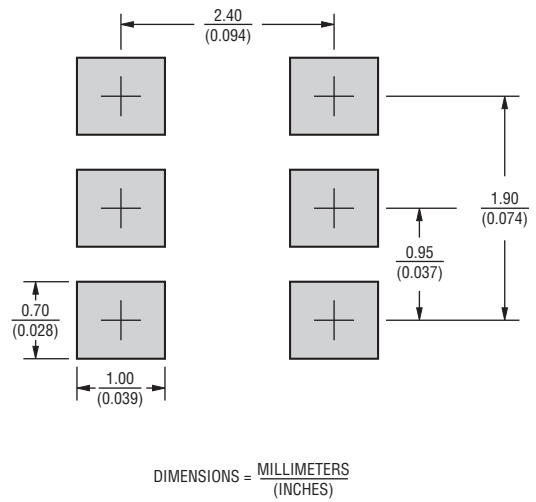

Block Diagram

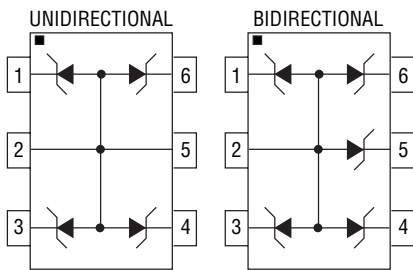

Typical Part Marking

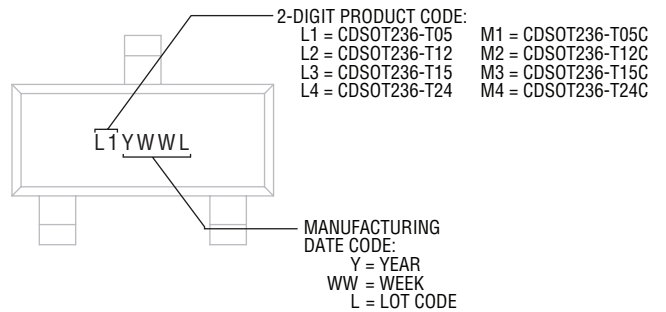

Specifications are subject to change without notice. The device characteristics and parameters in this data sheet can and do vary in different applications and actual device performance may vary over time. Users should verify actual device performance in their specific applications.

CDSOT236-T05~T24C Series - TVS Diode Arrays

BOURNS®

Performance Graphs

Peak Pulse Power vs. Pulse Time

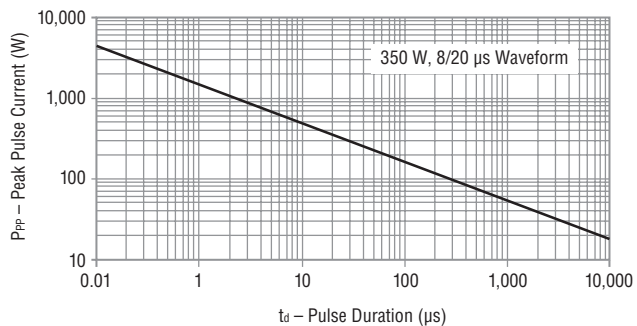

Pulse Waveform

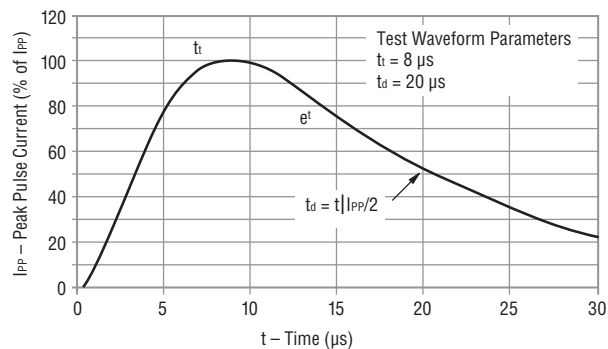

Power Derating Curve

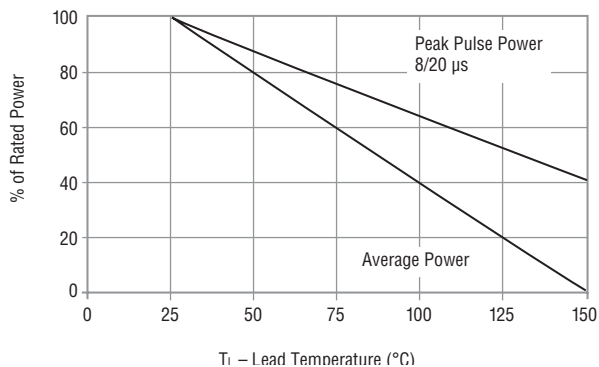

How to Order

CD SOT236 - T 05 C

Common Code _____
 Chip Diode _____
 Package _____
 SOT236 = SOT23-6 Package _____
 Model _____
 T = Transient Voltage Suppressor _____
 Working Peak Reverse Voltage _____
 05 = 5 V_{RWM} (Volts) _____
 Suffix _____
 C = Bidirectional Diode _____

Environmental Specifications

Moisture Sensitivity Level 1
 ESD Classification (HBM)..... 3B

Specifications are subject to change without notice.
 The device characteristics and parameters in this data sheet can and do vary in different applications and actual device performance may vary over time.
 Users should verify actual device performance in their specific applications.

CDSOT236-T05~T24C Series - TVS Diode Arrays

BOURNS®

Packaging Information

The product is packaged in tape and reel format per EIA-481 standard.

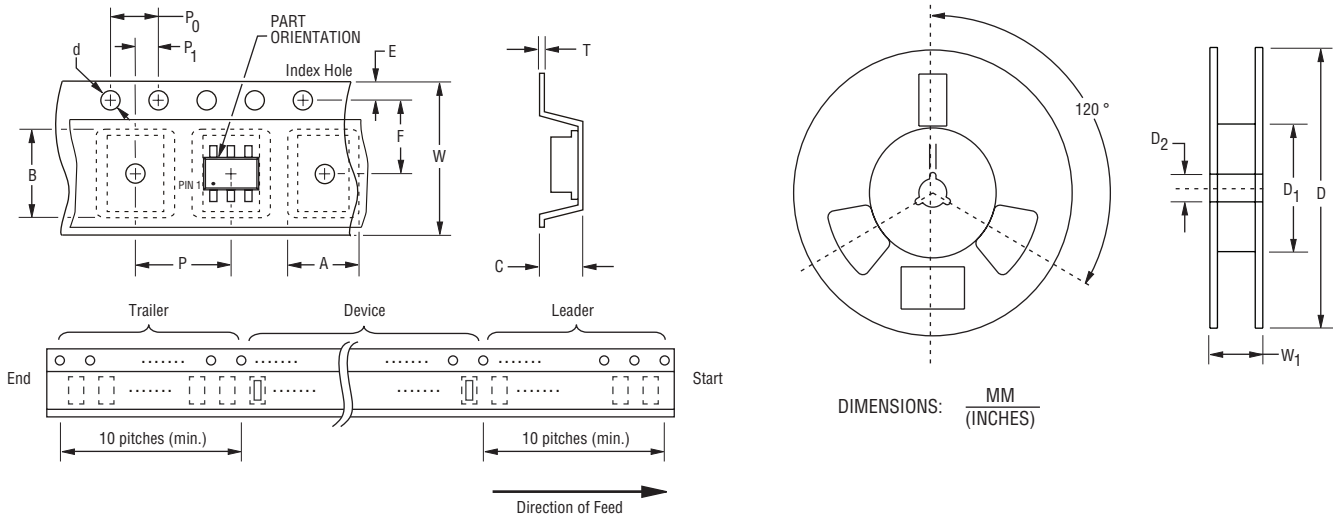

Item	Symbol	SOT23-6
Carrier Width	A	$\frac{3.90 \pm 0.10}{(0.154 \pm 0.004)}$
Carrier Length	B	$\frac{3.90 \pm 0.10}{(0.154 \pm 0.004)}$
Carrier Depth	C	$\frac{0.90 \pm 0.10}{(0.035 \pm 0.004)}$
Sprocket Hole	d	$\frac{1.55 \pm 0.05}{(0.061 \pm 0.002)}$
Reel Outside Diameter	D	$\frac{178}{(7.008)}$
Reel Inner Diameter	D ₁	$\frac{50.0}{(1.969)}$ MIN.
Feed Hole Diameter	D ₂	$\frac{13.0 \pm 0.20}{(0.512 \pm 0.008)}$
Sprocket Hole Position	E	$\frac{1.75 \pm 0.10}{(0.069 \pm 0.004)}$
Punch Hole Position	F	$\frac{3.50 \pm 0.05}{(0.138 \pm 0.002)}$
Punch Hole Pitch	P	$\frac{4.00 \pm 0.10}{(0.157 \pm 0.004)}$
Sprocket Hole Pitch	P ₀	$\frac{4.00 \pm 0.10}{(0.157 \pm 0.004)}$
Embossment Center	P ₁	$\frac{2.00 \pm 0.05}{(0.079 \pm 0.002)}$
Overall Tape Thickness	T	$\frac{0.20 \pm 0.10}{(0.008 \pm 0.004)}$
Tape Width	W	$\frac{8.00 \pm 0.20}{(0.315 \pm 0.008)}$
Reel Width	W ₁	$\frac{14.4}{(0.567)}$ MAX.
Quantity per Reel	--	3000

REV. 01/18

Specifications are subject to change without notice. The device characteristics and parameters in this data sheet can and do vary in different applications and actual device performance may vary over time. Users should verify actual device performance in their specific applications.

Looking for pricing, stock, or lifecycle information?

Click below to explore more details on WIN SOURCE:

- ⊖ [View CDSOT236-T24C on WIN SOURCE](#)
- ⊖ [Bourns Inc. Information](#)

Optimize Your Supply Chain with WIN SOURCE Solutions

- ✓ Global Sourcing Solution
- ✓ Obsolete Management
- ✓ Cost Control Management
- ✓ Shortage Management
- ✓ Alternative Solution
- ✓ Excess Inventory Management