



# THE DATASHEET OF TSH120ICT



## 2.2V to 5V video buffer with SAG correction

### Features

- Very low consumption
- Standby mode available
- Internal reconstruction filter
- Internal gain of 6dB
- Rail-to-rail output
- Tested with +2.5V and +3.3V single supply
- Operation supply from +2.2V to +5.5V
- SAG correction
- Excellent video performance
  - Differential gain 0.5%
  - Differential phase 0.5°
  - Group delay=10ns
- Specified for 150Ω load
- Input DC level shifter
- Min. and max. limits are tested in full production

### Applications

- Camera phones
- Digital still camera
- Digital video camera
- Set-top box and D\ D video outputs

### Description

The TSH120 is a video buffer that includes a voltage feedback amplifier with an internal gain of 6dB, rail-to-rail output, internal input biasing and SAG correction. A power down function offers a sleep mode with ultra low consumption.

The TSH120 also features an internal reconstruction filter in order to attenuate the parasitic 27MHz frequency from the clock of the video DAC.

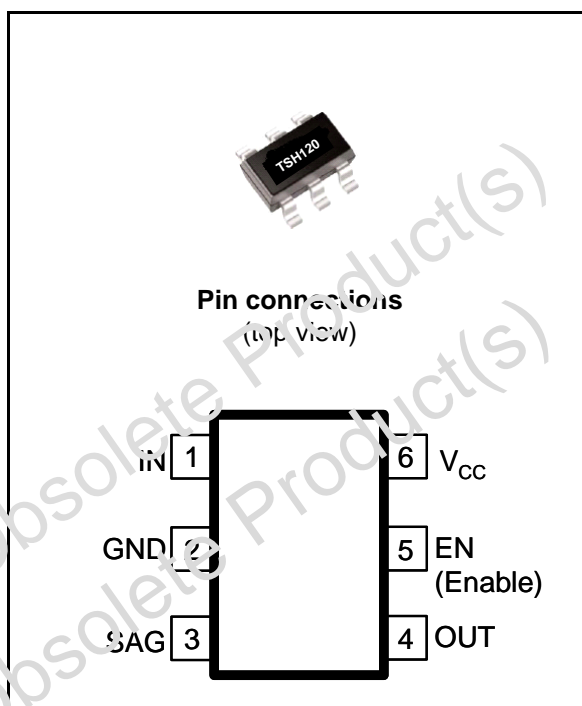

The TSH120 is a single operator available in a tiny SC70 plastic package for space saving.

# 1 Absolute maximum ratings

**Table 1. Absolute maximum ratings**

Symbol	Parameter	Value	Unit
V <sub>CC</sub>	Supply voltage <sup>(1)</sup>	6	V
V <sub>in</sub>	Input voltage range <sup>(2)</sup>	2	V
T <sub>oper</sub>	Operating free air temperature range	-40 to +105	°C
T <sub>stg</sub>	Storage temperature	-65 to +150	°C
T <sub>j</sub>	Maximum junction temperature	150	°C
R <sub>thja</sub>	Thermal resistance junction to ambient	430	°C/W
R <sub>thjc</sub>	Thermal resistance junction to case	58	°C/W
P <sub>max</sub>	Maximum power dissipation <sup>(3)</sup> for T <sub>j</sub> =150°C T <sub>a</sub> =+25°C T <sub>a</sub> =+85°C	290 150	mW
ESD	HBM: human body model <sup>(4)</sup> except pin-4 pin-4	2 1.5	kV
	MM: machine model <sup>(5)</sup>	200	V
	Latch-up immunity	200	mA

1. All voltage values are measured with respect to the ground pin.
2. The magnitude of input and output voltage must never exceed V<sub>CC</sub> +0.3V.
3. Short-circuits can cause excessive heating. Destructive dissipation can result from short-circuits on amplifiers.
4. Human body model: A 100pF capacitor is charged to the specified voltage, then discharged through a 1.5kΩ resistor between two pins of the device. This is done for all couples of connected pin combinations while the other pins are floating.
5. Machine model: A 200pF capacitor is charged to the specified voltage, then discharged directly between two pins of the device with no external series resistor (internal resistor < 5Ω). This is done for all couples of connected pin combinations while the other pins are floating. This is a minimum value.

**Table 2. Operating conditions**

Symbol	Parameter	Value	Unit
V <sub>CC</sub>	Supply voltage <sup>(1)</sup>	2.2 to 5.5	V

1. Tested in full production at +2.5V and +3.3V single supply voltage.

## 2 Electrical characteristics

**Table 3. Electrical characteristics for  $V_{CC} = +2.5V$  and  $+3.3V$ ,  $T_{amb} = 25^{\circ}C$  (unless otherwise specified)**

Symbol	Parameter	Test conditions	Min.	Typ.	Max.	Unit
<b>DC performance</b>						
$V_{dc}$	Output DC level shift	$R_L = 150\Omega$	94	129	158	mV
		$T_{min} \leq T_{amb} \leq T_{max}$		403		$\mu V/^{\circ}C$
$I_{ib}$	Input bias current	$V_{CC} = +3.3V$ $T_{min} \leq T_{amb} \leq T_{max}$	-880	-550 -650		nA
		$V_{CC} = +2.5V$ $T_{min} \leq T_{amb} \leq T_{max}$	-840	-550 -620		
G	Internal voltage gain	$V_{in} = 1V$ $T_{min} \leq T_{amb} \leq T_{max}$	5.95	6.1 6.05	6.2	dB
PSRR	Power supply rejection ratio $20 \log(\Delta V_{CC}/\Delta V_{out})$	$\Delta V_{CC} = \pm 100mV$ at 1MHz		55		dB
$I_{CC}$	Current consumption	No load, $V_{in} = +0.5V$ $V_{CC} = +3.3V$ $T_{min} \leq T_{amb} \leq T_{max}$		5.8 6.7	6.6	mA
		No load, $V_{in} = +0.5V$ $V_{CC} = +2.5V$ $T_{min} \leq T_{amb} \leq T_{max}$		5.8 6.7	6.3	mA
<b>Enable/standby (EN pin)</b>						
$I_{STBY}$	Consumption in standby mode	$V_{CC} = +3.3V$			4	$\mu A$
		$V_{CC} = +2.5V$			2	
$V_{STBY-low}$	Standby low level	Standby mode			+0.3	V
$V_{STBY-high}$	Standby high level	Enable mode	+0.8			V
$T_{on}$	Time from standby to enable			5		$\mu s$
$T_{off}$	Time from enable to standby			5		$\mu s$
<b>Dynamic performance and output characteristics</b>						
FR	Frequency response	$V_{out} = 2V_{pp}$ , $R_L = 150\Omega$ $V_{CC} = +3.3V$ , $F = 4.5MHz$ $T_{min} \leq T_{amb} \leq T_{max}$	-0.4	-0.1 -0.48	0.4	dB
		$V_{out} = 2V_{pp}$ , $R_L = 150\Omega$ $V_{CC} = +2.5V$ , $F = 4.5MHz$		0		
		$V_{CC} = +3.3V$ , $F = 27MHz$ $T_{min} \leq T_{amb} \leq T_{max}$	-20	-25 -23		
$V_{OH}$	High level output voltage	$V_{CC} = +3.3V$ , $R_L = 150\Omega$ $V_{CC} = +2.5V$ , $R_L = 150\Omega$	3.13 2.36	3.21 2.42		V

**Table 3. Electrical characteristics for  $V_{CC} = +2.5V$  and  $+3.3V$ ,  $T_{amb} = 25^{\circ}C$  (unless otherwise specified) (continued)**

Symbol	Parameter	Test conditions	Min.	Typ.	Max.	Unit
$V_{OL}$	Low level output voltage	$V_{in} = -100mV$ , $R_L = 150\Omega$ $V_{CC} = +3.3V$ $T_{min} \leq T_{amb} \leq T_{max}$		5 5.6	34	mV
		$V_{in} = -100mV$ , $R_L = 150\Omega$ $V_{CC} = +2.5V$ $T_{min} \leq T_{amb} \leq T_{max}$		5 5.5	33	
$I_{out}$	$I_{source}$	$V_{CC} = +3.3V$ , output to GND		30		mA
$\Delta G$	Differential gain	$V_{CC} = +3.3V$ , $R_L = 150\Omega$		0.5		%
$\Delta\phi$	Differential phase	$V_{CC} = +3.3V$ , $R_L = 150\Omega$		0.5		°
Gd	Group delay	10kHz to 6MHz			10 <sup>(1)</sup>	ns
<b>Noise</b>						
eN	Total output noise	F = 100kHz, no load		25		nV/√Hz
SNR	Output signal to noise ratio	$V_{CC} = +3.3V$ , $R_L = 150\Omega$ $V_{out} = 2V_{pp}$ from 0 to 6MHz		60		dB

1. Guaranteed by design. The parameter is not tested.

Figure 1. Frequency response

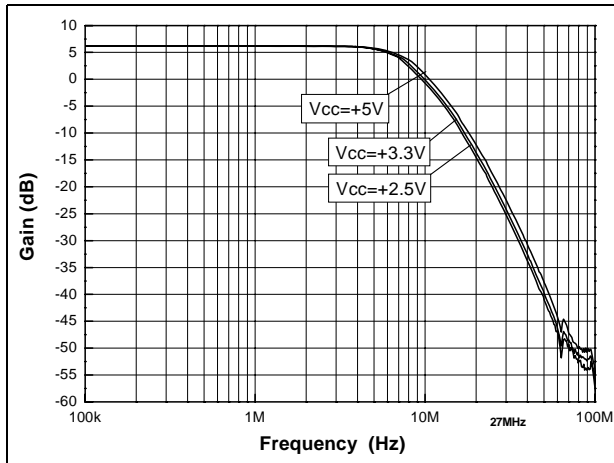

Figure 2. Gain flatness

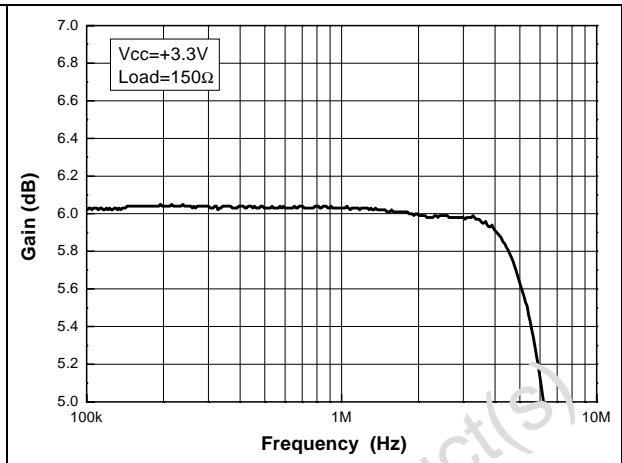

Figure 3. Total input noise vs. frequency

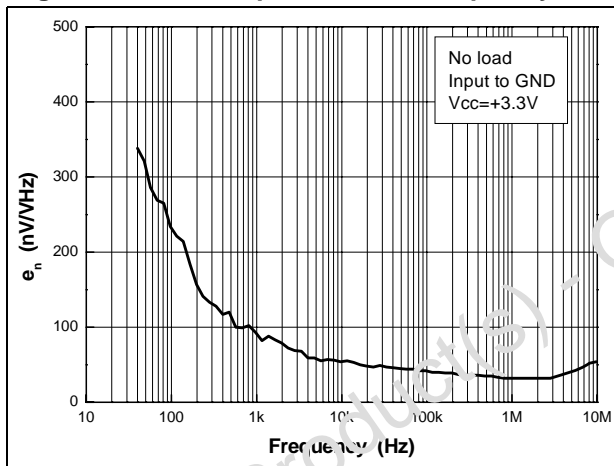

Figure 4. Distortion on 150Ω load

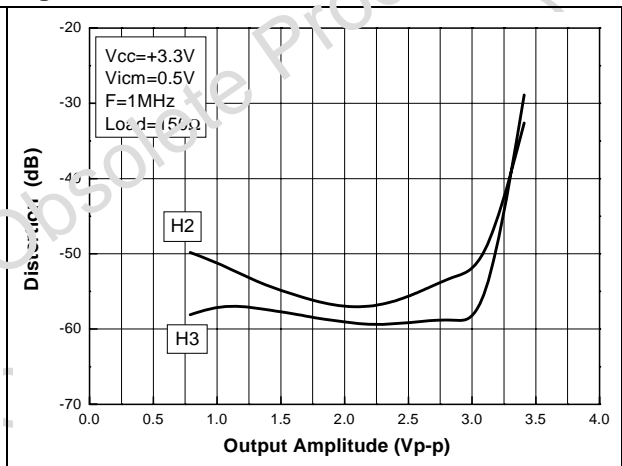

Figure 5. Output voltage swing vs. supply

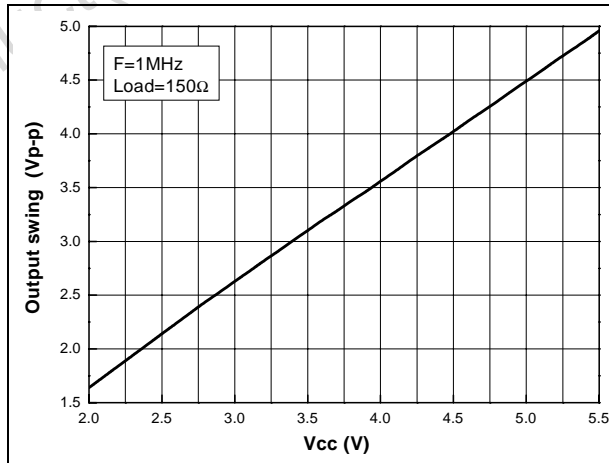

Figure 6. Quiescent current vs. supply

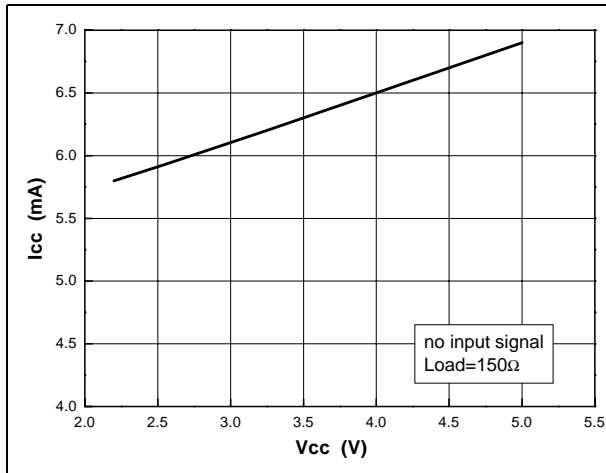

Figure 7. Output DC shift vs. V<sub>CC</sub>

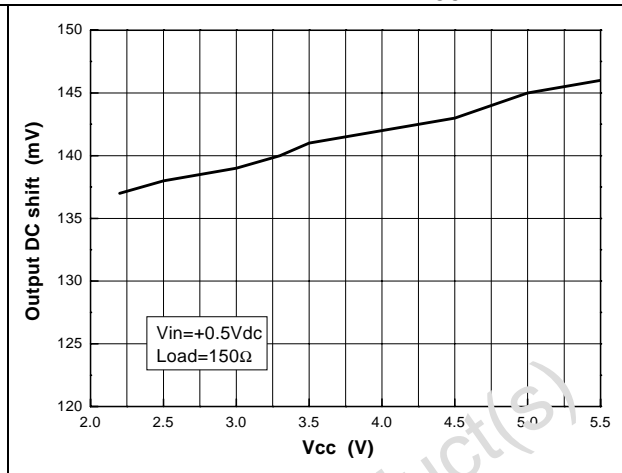

Figure 8. Standby - Output T<sub>on</sub> (V<sub>CC</sub>=+3.3V)

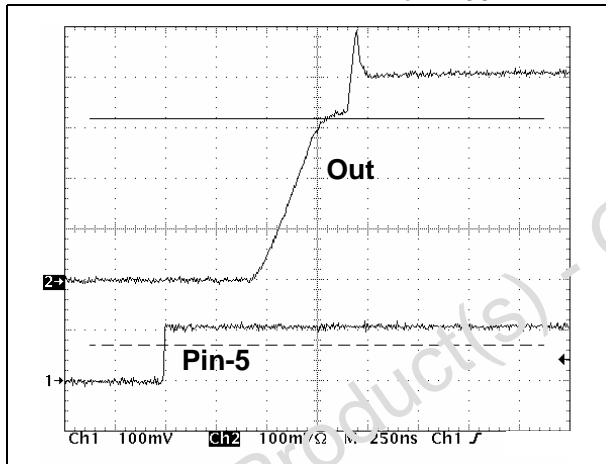

Figure 9. Standby - Output T<sub>off</sub> (V<sub>CC</sub>=+3.3V)

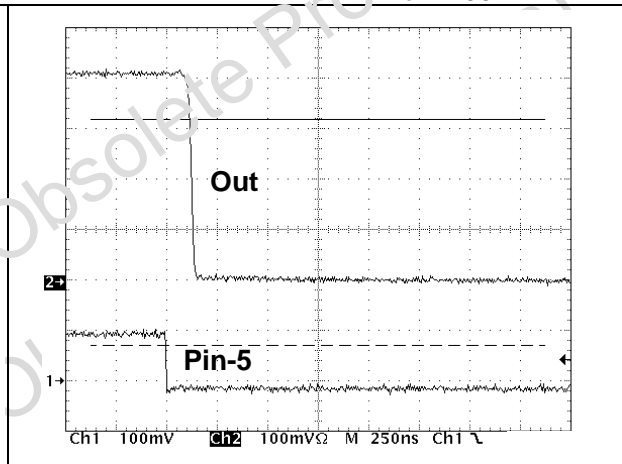

Figure 10. Flatness vs. T<sub>amb</sub>

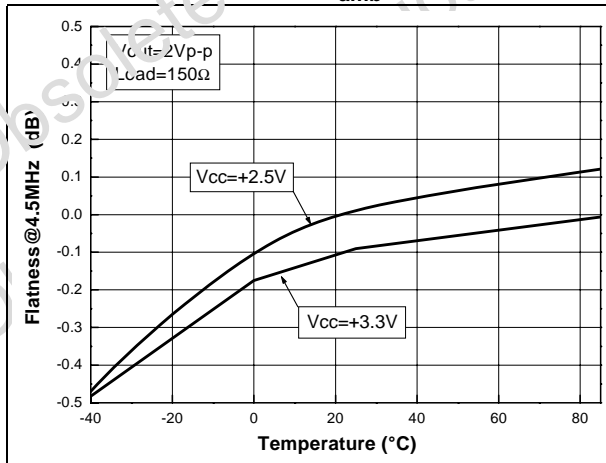

Figure 11. I<sub>bias</sub> vs. T<sub>amb</sub>

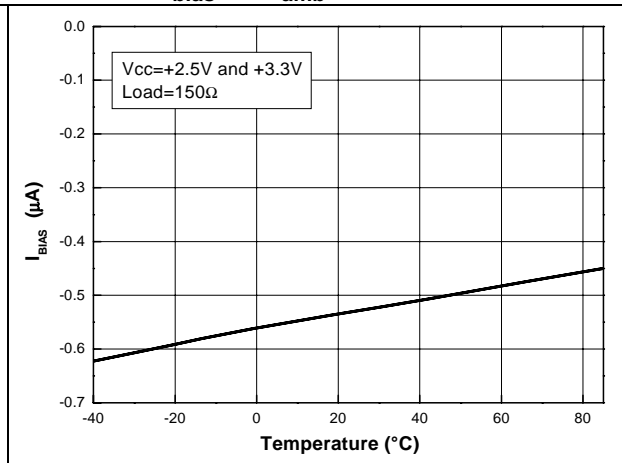

Figure 12. Voltage gain vs.  $T_{amb}$

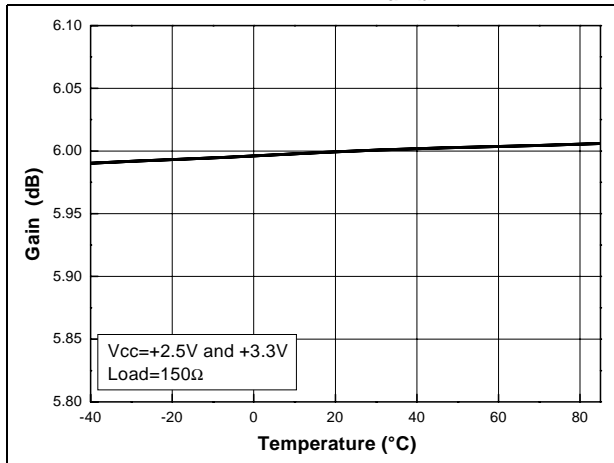

Figure 13. Filter attenuation vs.  $T_{amb}$

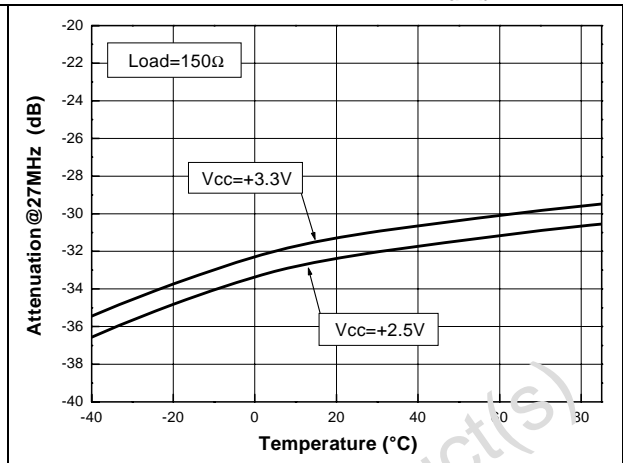

Figure 14. Supply current vs.  $T_{amb}$

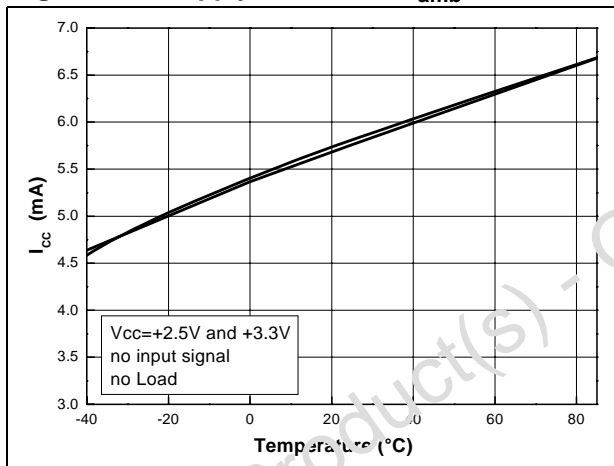

Figure 15. Output DC shift vs.  $T_{amb}$

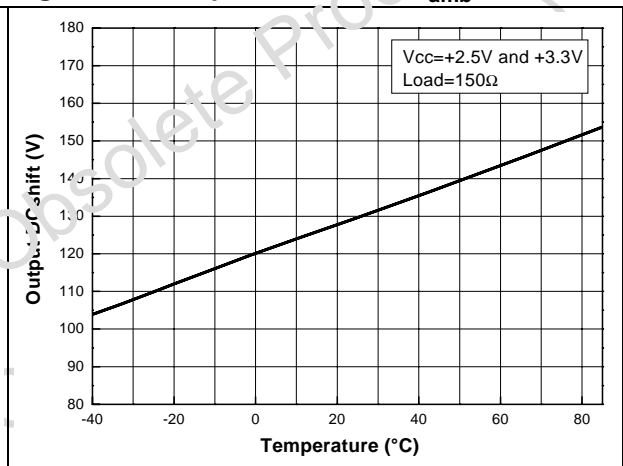

Figure 16.  $V_{OH}$  vs.  $T_{amb}$

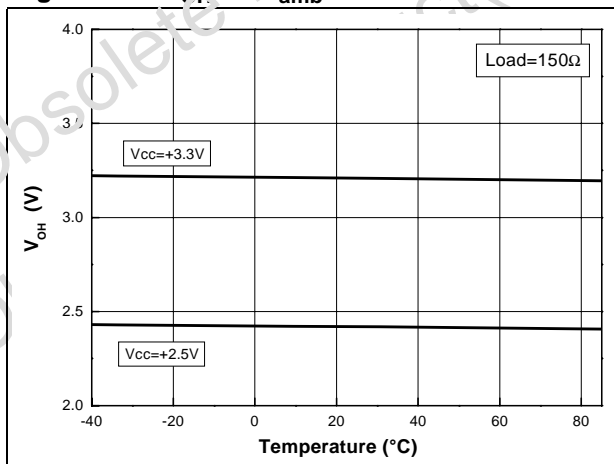
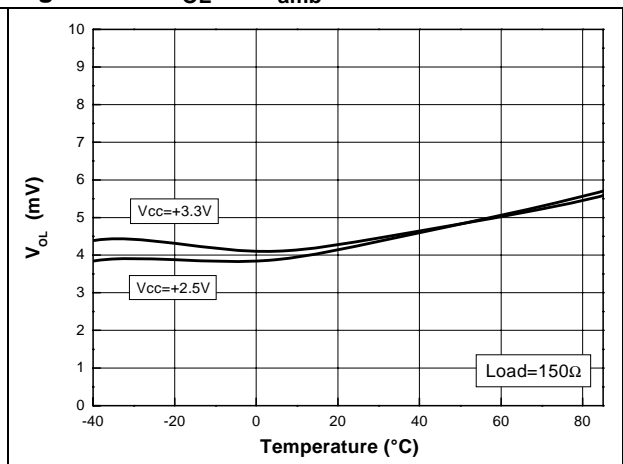

Figure 17.  $V_{OL}$  vs.  $T_{amb}$



### 3 Implementation in the application

This section explains how the TSH120 video buffer operates in a typical application.

On the input, a DC level shifter optimizes the position of the video signal with no clamping on the output rails. The filter is a reconstruction filter. It is used to attenuate the DAC's sampling frequency which causes a parasitic signal in the video spectrum (typically at 27MHz in the case of standard video). This function must be achieved while keeping a low group delay.

On the output, the SAG correction decreases  $C_{out}$  while keeping a very low frequency pole (see [Figure 18](#)). Nevertheless, the output can be directly connected to the line without any capacitor. In this case, both OUT and SAG pins are connected together and the equivalent gain of the buffer remains 6dB (see [Figure 19](#)).

Figure 18. Schematic diagram with output capacitor

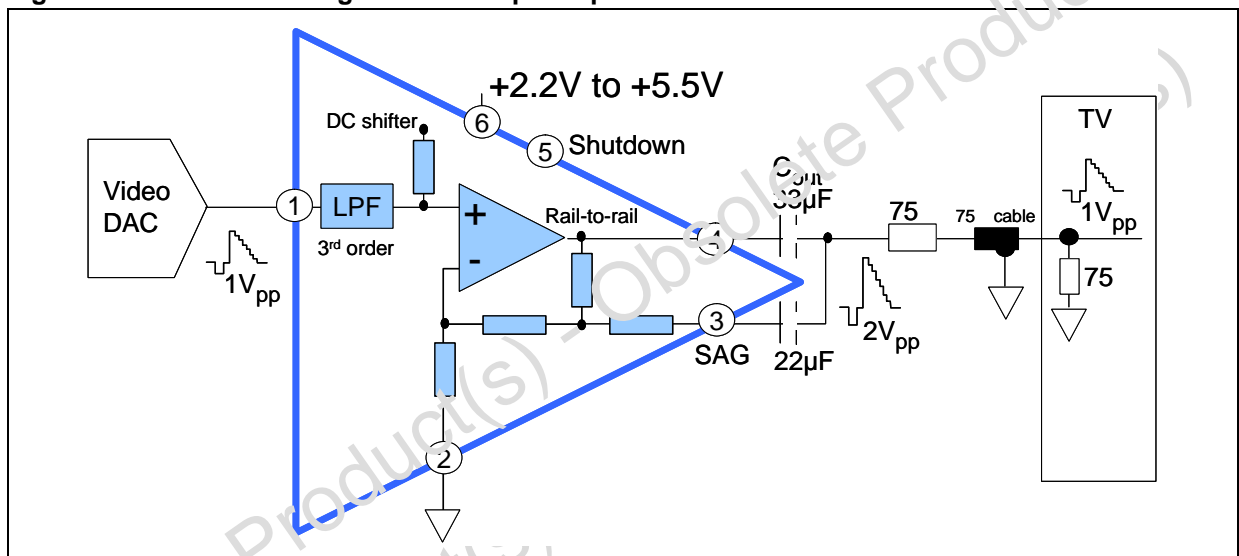
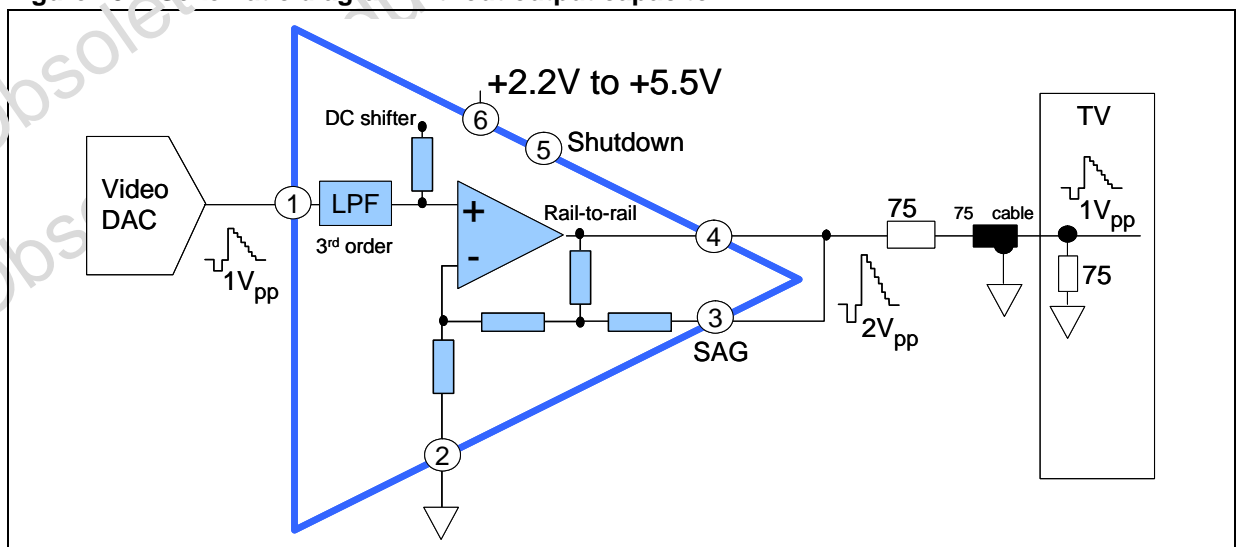

Figure 19. Schematic diagram without output capacitor



## 4 Power supply considerations

Correct power supply bypassing is very important for optimizing performance in the high-frequency range. A bypass capacitor greater than 10μF is necessary to minimize the distortion. For better quality bypassing at higher frequencies, a capacitor of 10nF must be added as close as possible to the IC pin of V<sub>CC</sub>.

**Figure 20. Circuit for power supply bypassing**

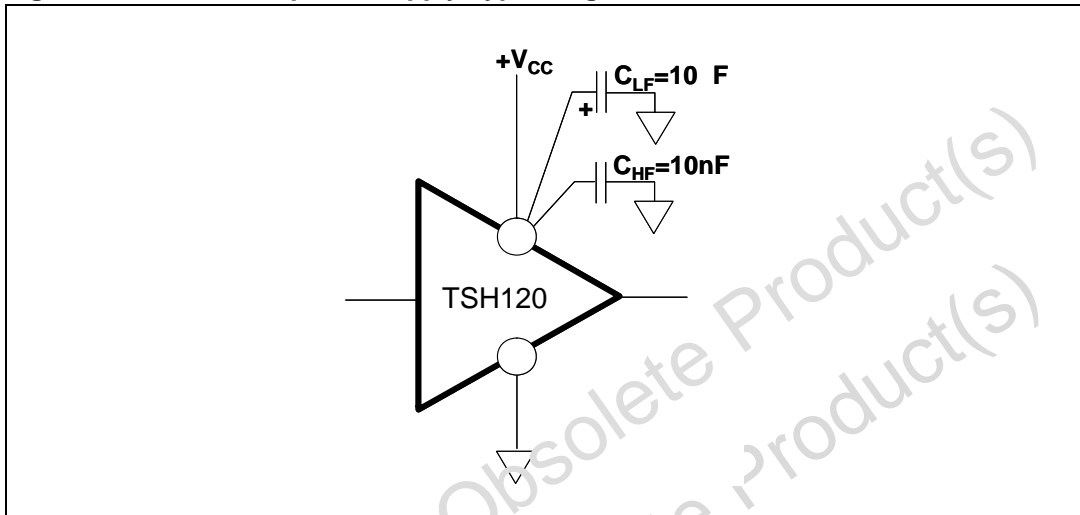
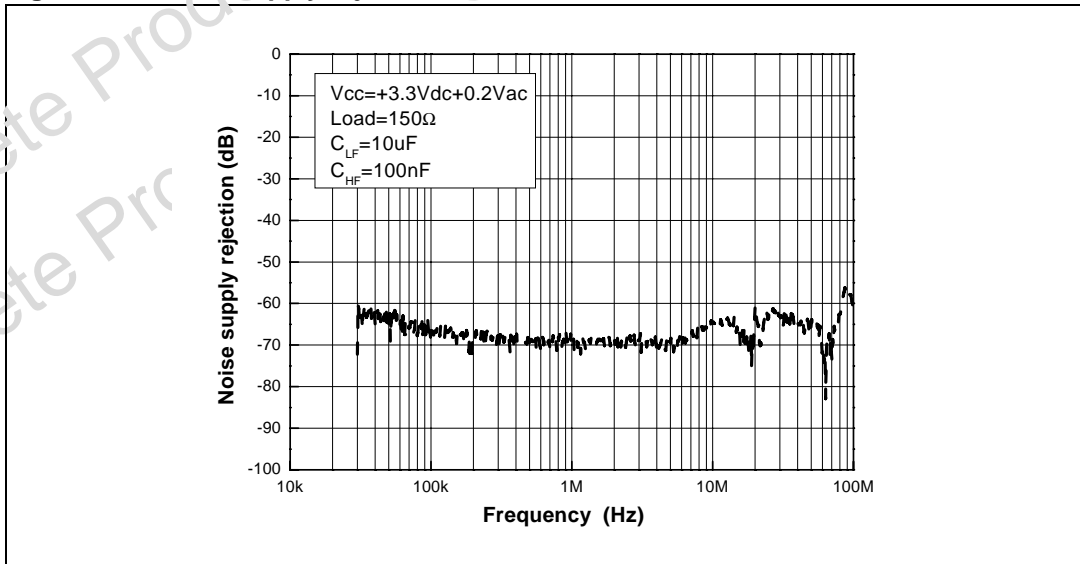

Figure 21 shows the noise supply rejection improvement with bypass capacitors expressed by:

$$20 \log (\Delta V_{out} / \Delta V_{CC})$$

**Figure 21. Noise supply rejection**



## 5 Package information

In order to meet environmental requirements, STMicroelectronics offers these devices in ECOPACK<sup>®</sup> packages. These packages have a lead-free second level interconnect. The category of second level interconnect is marked on the package and on the inner box label, in compliance with JEDEC Standard JESD97. The maximum ratings related to soldering conditions are also marked on the inner box label. ECOPACK is an STMicroelectronics trademark. ECOPACK specifications are available at: [www.st.com](http://www.st.com).

**Figure 22. SC70-6 (or SOT323-6) package footprint (in millimeters)**

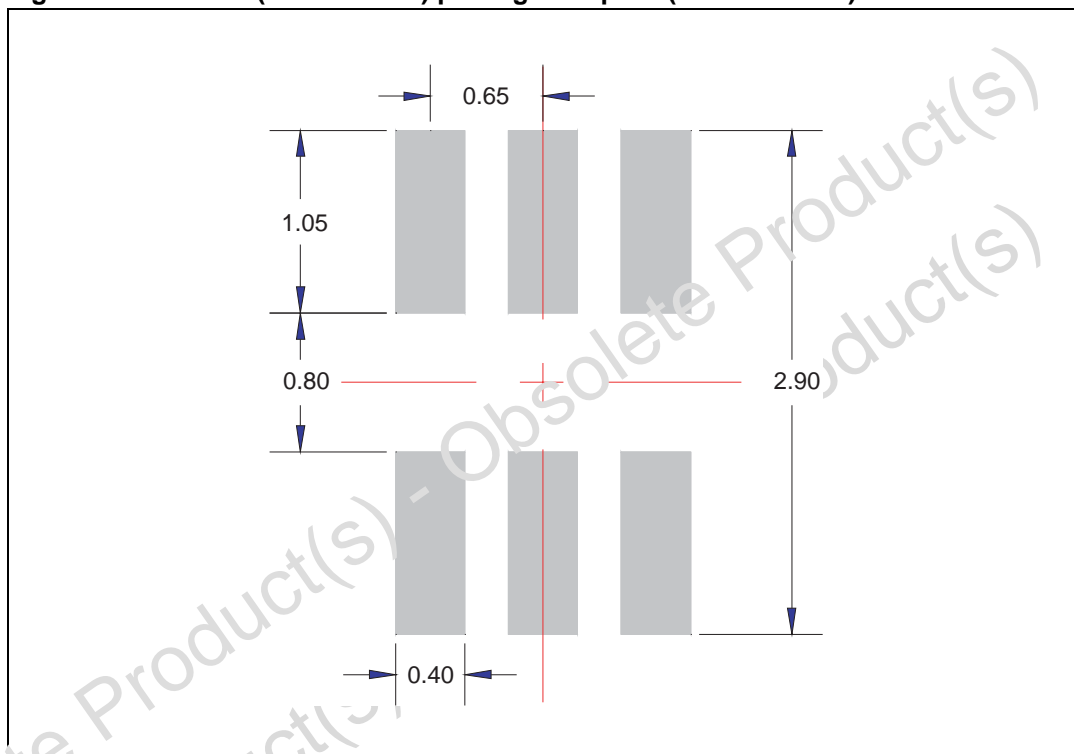
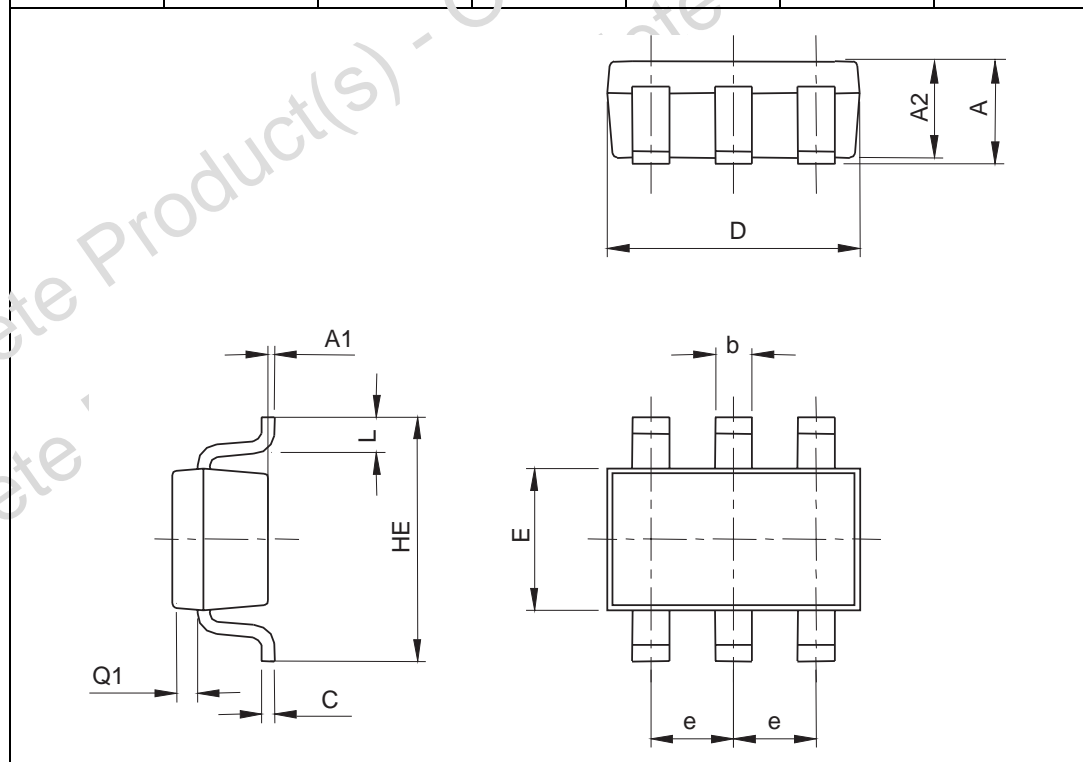

Figure 23. SC70-6 (or SOT323-6) package mechanical data

Ref	Dimensions					
	Millimeters			Mils		
	Min	Typ	Max	Min	Typ	Max
A	0.80		1.10	31.5		43.3
A1	0		0.10	0		3.9
A2	0.80		1.00	31.5		39.3
b	0.15		0.30	5.9		11.8
c	0.10		0.18	3.9		7.0
D	1.80		2.20	70.8		86.6
E	1.15		1.35	45.2		43.1
e		0.65			25.6	
HE	1.8		2.4	70.8		94.5
L	0.10		0.40	3.9		15.7
Q1	0.10		0.40	3.9		15.7



## 6 Ordering information

**Table 4. Order codes**

Part number	Temperature range	Package	Packaging	Marking
TSH120ICT	-40°C to +85°C	SC70-6 (or SOT323-6)	Tape & reel	K30

## 7 Revision history

**Table 5. Document revision history**

Date	Revision	Changes
29-May-2007	1	Initial version, preliminary data.
20-Jun-2007	2	First complete datasheet.
21-Aug-2007	3	Corrected pinout diagram on cover page (SAG missing).

**Please Read Carefully:**

Information in this document is provided solely in connection with ST products. STMicroelectronics NV and its subsidiaries ("ST") reserve the right to make changes, corrections, modifications or improvements, to this document, and the products and services described herein at any time, without notice.

All ST products are sold pursuant to ST's terms and conditions of sale.

Purchasers are solely responsible for the choice, selection and use of the ST products and services described herein, and ST assumes no liability whatsoever relating to the choice, selection or use of the ST products and services described herein.

No license, express or implied, by estoppel or otherwise, to any intellectual property rights is granted under this document. If any part of this document refers to any third party products or services it shall not be deemed a license grant by ST for the use of such third party products or services, or any intellectual property contained therein or considered as a warranty covering the use in any manner whatsoever of such third party products or services or any intellectual property contained therein.

**UNLESS OTHERWISE SET FORTH IN ST'S TERMS AND CONDITIONS OF SALE ST DISCLAIMS ANY EXPRESS OR IMPLIED WARRANTY WITH RESPECT TO THE USE AND/OR SALE OF ST PRODUCTS INCLUDING WITHOUT LIMITATION IMPLIED WARRANTIES OF MERCHANTABILITY, FITNESS FOR A PARTICULAR PURPOSE (AND THEIR EQUIVALENTS UNDER THE LAWS OF ANY JURISDICTION), OR INFRINGEMENT OF ANY PATENT, COPYRIGHT OR OTHER INTELLECTUAL PROPERTY RIGHT.**

**UNLESS EXPRESSLY APPROVED IN WRITING BY AN AUTHORIZED ST REPRESENTATIVE, ST PRODUCTS ARE NOT RECOMMENDED, AUTHORIZED OR WARRANTED FOR USE IN MILITARY, AIR CRAFT, SPACE, LIFE SAVING, OR LIFE SUSTAINING APPLICATIONS, NOR IN PRODUCTION OR SYSTEMS WHERE FAILURE OR MALFUNCTION MAY RESULT IN PERSONAL INJURY, DEATH, OR SEVERE PROPERTY OR ENVIRONMENTAL DAMAGE. ST PRODUCTS WHICH ARE NOT SPECIFIED AS "AUTOMOTIVE GRADE" MAY ONLY BE USED IN AUTOMOTIVE APPLICATIONS AT USER'S OWN RISK.**

Resale of ST products with provisions different from the statements and/or technical features set forth in this document shall immediately void any warranty granted by ST for the ST product or service described herein and shall not create or extend in any manner whatsoever, any liability of ST.

ST and the ST logo are trademarks or registered trademarks of ST in various countries.

Information in this document supersedes and replaces all information previously supplied.

The ST logo is a registered trademark of STMicroelectronics. All other names are the property of their respective owners.

© 2007 STMicroelectronics - All rights reserved



STMicroelectronics group of companies

Australia - Belgium - Brazil - Canada - China - Czech Republic - Finland - France - Germany - Hong Kong - India - Israel - Italy - Japan - Malaysia - Malta - Morocco - Singapore - Spain - Sweden - Switzerland - United Kingdom - United States of America

[www.st.com](http://www.st.com)

## Looking for pricing, stock, or lifecycle information?

Click below to explore more details on WIN SOURCE:

-  [View TSH120ICT](#) on WIN SOURCE
-  [STMicroelectronics](#) Information

## Optimize Your Supply Chain with WIN SOURCE Solutions

-  Global Sourcing Solution
-  Obsolete Management
-  Cost Control Management
-  Shortage Management
-  Alternative Solution
-  Excess Inventory Management