



**THE DATASHEET OF
LM7171AIN/NOPB**



LM7171

LM7171 Very High Speed, High Output Current, Voltage Feedback Amplifier



Literature Number: SNOS760A

LM7171

Very High Speed, High Output Current, Voltage Feedback Amplifier

General Description

The LM7171 is a high speed voltage feedback amplifier that has the slewing characteristic of a current feedback amplifier; yet it can be used in all traditional voltage feedback amplifier configurations. The LM7171 is stable for gains as low as +2 or -1. It provides a very high slew rate at 4100V/ μ s and a wide unity-gain bandwidth of 200 MHz while consuming only 6.5 mA of supply current. It is ideal for video and high speed signal processing applications such as HDSL and pulse amplifiers. With 100 mA output current, the LM7171 can be used for video distribution, as a transformer driver or as a laser diode driver.

Operation on $\pm 15V$ power supplies allows for large signal swings and provides greater dynamic range and signal-to-noise ratio. The LM7171 offers low SFDR and THD, ideal for ADC/DAC systems. In addition, the LM7171 is specified for $\pm 5V$ operation for portable applications.

The LM7171 is built on National's advanced VIP™ III (Vertically integrated PNP) complementary bipolar process.

Features

(Typical Unless Otherwise Noted)

- Easy-to-use voltage feedback topology
- Very high slew rate: 4100 V/ μ s
- Wide unity-gain bandwidth: 200 MHz
- -3 dB frequency @ $A_v = +2$: 220 MHz
- Low supply current: 6.5 mA
- High open loop gain: 85 dB
- High output current: 100 mA
- Differential gain and phase: 0.01%, 0.02°
- Specified for $\pm 15V$ and $\pm 5V$ operation

Applications

- HDSL and ADSL drivers
- Multimedia broadcast systems
- Professional video cameras
- Video amplifiers
- Copiers/scanners/fax
- HDTV amplifiers
- Pulse amplifiers and peak detectors
- CATV/fiber optics signal processing

Typical Performance

Large Signal Pulse Response
 $A_v = +2, V_s = \pm 15V$

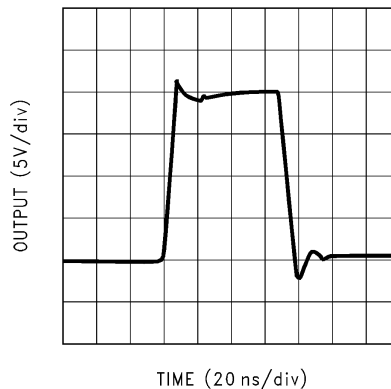

01238501

VIP™ is a trademark of National Semiconductor Corporation.

Absolute Maximum Ratings (Note 1)

If Military/Aerospace specified devices are required, please contact the National Semiconductor Sales Office/Distributors for availability and specifications.

ESD Tolerance (Note 2)	2.5 kV
Supply Voltage ($V^+ - V^-$)	36V
Differential Input Voltage (Note 11)	$\pm 10V$
Output Short Circuit to Ground (Note 3)	Continuous
Storage Temperature Range	-65°C to $+150^\circ\text{C}$

Maximum Junction Temperature (Note 4)

150°C

Operating Ratings (Note 1)

Supply Voltage	$5.5V \leq V_S \leq 36V$
Junction Temperature Range	$-40^\circ\text{C} \leq T_J \leq +85^\circ\text{C}$
LM7171AI, LM7171BI	
Thermal Resistance (θ_{JA})	
8-Pin MDIP	108°C/W
8-Pin SOIC	172°C/W

 $\pm 15V$ DC Electrical Characteristics

Unless otherwise specified, all limits guaranteed for $T_J = 25^\circ\text{C}$, $V^+ = +15V$, $V^- = -15V$, $V_{CM} = 0V$, and $R_L = 1\text{ k}\Omega$. **Boldface** limits apply at the temperature extremes

Symbol	Parameter	Conditions	Typ (Note 5)	LM7171AI Limit (Note 6)	LM7171BI Limit (Note 6)	Units
V_{OS}	Input Offset Voltage		0.2	1 4	3 7	mV max
TC V_{OS}	Input Offset Voltage Average Drift		35			$\mu\text{V}/^\circ\text{C}$
I_B	Input Bias Current		2.7	10 12	10 12	μA max
I_{OS}	Input Offset Current		0.1	4 6	4 6	μA max
R_{IN}	Input Resistance	Common Mode	40			M Ω
		Differential Mode	3.3			
R_O	Open Loop Output Resistance		15			Ω
CMRR	Common Mode Rejection Ratio	$V_{CM} = \pm 10V$	105	85 80	75 70	dB min
PSRR	Power Supply Rejection Ratio	$V_S = \pm 15V$ to $\pm 5V$	90	85 80	75 70	dB min
V_{CM}	Input Common-Mode Voltage Range	CMRR > 60 dB	± 13.35			V
A_V	Large Signal Voltage Gain (Note 7)	$R_L = 1\text{ k}\Omega$	85	80 75	75 70	dB min
		$R_L = 100\Omega$	81	75 70	70 66	dB min
V_O	Output Swing	$R_L = 1\text{ k}\Omega$	13.3	13 12.7	13 12.7	V min
			-13.2	-13 -12.7	-13 -12.7	V max
		$R_L = 100\Omega$	11.8	10.5 9.5	10.5 9.5	V min
			-10.5	-9.5 -9	-9.5 -9	V max
	Output Current (Open Loop) (Note 8)	Sourcing, $R_L = 100\Omega$	118	105 95	105 95	mA min
		Sinking, $R_L = 100\Omega$	105	95 90	95 90	mA max

±15V DC Electrical Characteristics (Continued)

Unless otherwise specified, all limits guaranteed for $T_J = 25^\circ\text{C}$, $V^+ = +15\text{V}$, $V^- = -15\text{V}$, $V_{\text{CM}} = 0\text{V}$, and $R_L = 1\text{ k}\Omega$. **Boldface** limits apply at the temperature extremes

Symbol	Parameter	Conditions	Typ (Note 5)	LM7171AI Limit (Note 6)	LM7171BI Limit (Note 6)	Units
	Output Current (in Linear Region)	Sourcing, $R_L = 100\Omega$	100			mA
		Sinking, $R_L = 100\Omega$	100			
I_{SC}	Output Short Circuit Current	Sourcing	140			mA
		Sinking	135			
I_S	Supply Current		6.5	8.5	8.5	mA
				9.5	9.5	

±15V AC Electrical Characteristics

Unless otherwise specified, $T_J = 25^\circ\text{C}$, $V^+ = +15\text{V}$, $V^- = -15\text{V}$, $V_{\text{CM}} = 0\text{V}$, and $R_L = 1\text{ k}\Omega$.

Symbol	Parameter	Conditions	Typ (Note 5)	LM7171AI Limit (Note 6)	LM7171BI Limit (Note 6)	Units
SR	Slew Rate (Note 9)	$A_V = +2$, $V_{\text{IN}} = 13\text{ V}_{\text{PP}}$	4100			V/ μs
		$A_V = +2$, $V_{\text{IN}} = 10\text{ V}_{\text{PP}}$	3100			
	Unity-Gain Bandwidth		200			MHz
	-3 dB Frequency	$A_V = +2$	220			MHz
ϕ_m	Phase Margin		50			Deg
t_s	Settling Time (0.1%)	$A_V = -1$, $V_O = \pm 5\text{V}$ $R_L = 500\Omega$	42			ns
t_p	Propagation Delay	$A_V = -2$, $V_{\text{IN}} = \pm 5\text{V}$, $R_L = 500\Omega$	5			ns
A_D	Differential Gain (Note 10)		0.01			%
ϕ_D	Differential Phase (Note 10)		0.02			Deg
	Second Harmonic (Note 12)	$f_{\text{IN}} = 10\text{ kHz}$	-110			dBc
		$f_{\text{IN}} = 5\text{ MHz}$	-75			
	Third Harmonic (Note 12)	$f_{\text{IN}} = 10\text{ kHz}$	-115			dBc
		$f_{\text{IN}} = 5\text{ MHz}$	-55			
e_n	Input-Referred Voltage Noise	$f = 10\text{ kHz}$	14			$\frac{\text{nV}}{\sqrt{\text{Hz}}}$
i_n	Input-Referred Current Noise	$f = 10\text{ kHz}$	1.5			$\frac{\text{pA}}{\sqrt{\text{Hz}}}$

±5V DC Electrical Characteristics

Unless otherwise specified, all limits guaranteed for $T_J = 25^\circ\text{C}$, $V^+ = +5\text{V}$, $V^- = -5\text{V}$, $V_{\text{CM}} = 0\text{V}$, and $R_L = 1\text{ k}\Omega$. **Boldface** limits apply at the temperature extremes

Symbol	Parameter	Conditions	Typ (Note 5)	LM7171AI Limit (Note 6)	LM7171BI Limit (Note 6)	Units
V_{OS}	Input Offset Voltage		0.3	1.5 4	3.5 7	mV max
TC V_{OS}	Input Offset Voltage Average Drift		35			$\mu\text{V}/^\circ\text{C}$
I_B	Input Bias Current		3.3	10 12	10 12	μA max
I_{OS}	Input Offset Current		0.1	4	4	μA

±5V DC Electrical Characteristics (Continued)

Unless otherwise specified, all limits guaranteed for $T_J = 25^\circ\text{C}$, $V^+ = +5\text{V}$, $V^- = -5\text{V}$, $V_{\text{CM}} = 0\text{V}$, and $R_L = 1\text{ k}\Omega$. **Boldface** limits apply at the temperature extremes

Symbol	Parameter	Conditions	Typ (Note 5)	LM7171AI Limit (Note 6)	LM7171BI Limit (Note 6)	Units
				6	6	max
R_{IN}	Input Resistance	Common Mode	40			$\text{M}\Omega$
		Differential Mode	3.3			
R_{O}	Output Resistance		15			Ω
CMRR	Common Mode Rejection Ratio	$V_{\text{CM}} = \pm 2.5\text{V}$	104	80	70	dB
				75	65	min
PSRR	Power Supply Rejection Ratio	$V_S = \pm 15\text{V to } \pm 5\text{V}$	90	85	75	dB
				80	70	min
V_{CM}	Input Common-Mode Voltage Range	CMRR > 60 dB	± 3.2			V
A_V	Large Signal Voltage Gain (Note 7)	$R_L = 1\text{ k}\Omega$	78	75	70	dB
		$R_L = 100\Omega$	76	72	68	dB
V_{O}	Output Swing	$R_L = 1\text{ k}\Omega$	3.4	3.2	3.2	V
			-3.4	-3.2	-3.2	V
		$R_L = 100\Omega$	3	3	min	
			-3	-3	max	
$R_L = 100\Omega$	3.1	2.9	2.9	V		
	-3.0	-2.9	-2.9	V		
	Output Current (Open Loop) (Note 8)	Sourcing, $R_L = 100\Omega$	31	29	29	mA
		Sinking, $R_L = 100\Omega$	30	29	29	mA
I_{SC}	Output Short Circuit Current	Sourcing	135			mA
		Sinking	100			
I_S	Supply Current		6.2	8	8	mA
				9	9	max

±5V AC Electrical Characteristics

Unless otherwise specified, $T_J = 25^\circ\text{C}$, $V^+ = +5\text{V}$, $V^- = -5\text{V}$, $V_{\text{CM}} = 0\text{V}$, and $R_L = 1\text{ k}\Omega$.

Symbol	Parameter	Conditions	Typ (Note 5)	LM7171AI Limit (Note 6)	LM7171BI Limit (Note 6)	Units
SR	Slew Rate (Note 9)	$A_V = +2$, $V_{\text{IN}} = 3.5\text{ V}_{\text{PP}}$	950			$\text{V}/\mu\text{s}$
	Unity-Gain Bandwidth		125			MHz
	-3 dB Frequency	$A_V = +2$	140			MHz
ϕ_m	Phase Margin		57			Deg
t_s	Settling Time (0.1%)	$A_V = -1$, $V_{\text{O}} = \pm 1\text{V}$, $R_L = 500\Omega$	56			ns
t_p	Propagation Delay	$A_V = -2$, $V_{\text{IN}} = \pm 1\text{V}$, $R_L = 500\Omega$	6			ns
A_D	Differential Gain (Note 1)		0.02			%
ϕ_D	Differential Phase (Note 10)		0.03			Deg

±5V AC Electrical Characteristics (Continued)Unless otherwise specified, $T_J = 25^\circ\text{C}$, $V^+ = +5\text{V}$, $V^- = -5\text{V}$, $V_{\text{CM}} = 0\text{V}$, and $R_L = 1\text{ k}\Omega$.

Symbol	Parameter	Conditions	Typ (Note 5)	LM7171AI Limit (Note 6)	LM7171BI Limit (Note 6)	Units
	Second Harmonic (Note 12)	$f_{\text{IN}} = 10\text{ kHz}$	-102			dBc
		$f_{\text{IN}} = 5\text{ MHz}$	-70			dBc
	Third Harmonic (Note 12)	$f_{\text{IN}} = 10\text{ kHz}$	-110			dBc
		$f_{\text{IN}} = 5\text{ MHz}$	-51			dBc
e_n	Input-Referred Voltage Noise	$f = 10\text{ kHz}$	14			$\frac{\text{nV}}{\sqrt{\text{Hz}}}$
i_n	Input-Referred Current Noise	$f = 10\text{ kHz}$	1.8			$\frac{\text{pA}}{\sqrt{\text{Hz}}}$

Note 1: Absolute Maximum Ratings indicate limits beyond which damage to the device may occur. Operating Ratings indicate conditions for which the device is intended to be functional, but specific performance is not guaranteed. For guaranteed specifications and the test conditions, see the Electrical Characteristics.

Note 2: Human body model, 1.5 k Ω in series with 100 pF.

Note 3: Applies to both single-supply and split-supply operation. Continuous short circuit operation at elevated ambient temperature can result in exceeding the maximum allowed junction temperature of 150°C.

Note 4: The maximum power dissipation is a function of $T_{\text{J(MAX)}}$, θ_{JA} , and T_{A} . The maximum allowable power dissipation at any ambient temperature is $P_{\text{D}} = (T_{\text{J(MAX)}} - T_{\text{A}}) / \theta_{\text{JA}}$. All numbers apply for packages soldered directly into a PC board.

Note 5: Typical values represent the most likely parametric norm.

Note 6: All limits are guaranteed by testing or statistical analysis.

Note 7: Large signal voltage gain is the total output swing divided by the input signal required to produce that swing. For $V_{\text{S}} = \pm 15\text{V}$, $V_{\text{OUT}} = \pm 5\text{V}$. For $V_{\text{S}} = \pm 5\text{V}$, $V_{\text{OUT}} = \pm 1\text{V}$.

Note 8: The open loop output current is guaranteed, by the measurement of the open loop output voltage swing, using 100 Ω output load.

Note 9: Slew Rate is the average of the raising and falling slew rates.

Note 10: Differential gain and phase are measured with $A_{\text{V}} = +2$, $V_{\text{IN}} = 1\text{ V}_{\text{PP}}$ at 3.58 MHz and both input and output 75 Ω terminated.

Note 11: Input differential voltage is applied at $V_{\text{S}} = \pm 15\text{V}$.

Note 12: Harmonics are measured with $V_{\text{IN}} = 1\text{ V}_{\text{PP}}$, $A_{\text{V}} = +2$ and $R_L = 100\Omega$.

Note 13: The THD measurement at low frequency is limited by the test instrument.

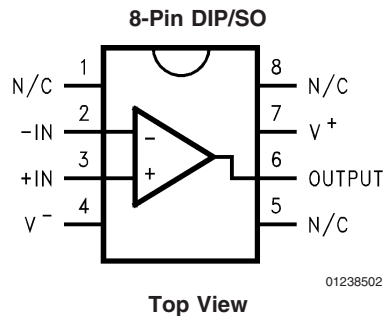
Connection Diagram**Ordering Information**

Package	Temperature Range		Transport Media	NSC Drawing
	Industrial -40°C to +85°C	Military -55°C to +125°C		
8-Pin SOIC	LM7171AIM		Rails	M08A
	LM7171AIMX		Tape and Reel	
	LM7171BIM		Rails	
	LM7171BIMX		Tape and Reel	
8-Pin MDIP	LM7171AIN		Rails	N08E
	LM7171BIN		Rails	

Typical Performance Characteristics unless otherwise noted, $T_A = 25^\circ\text{C}$

Supply Current vs. Supply Voltage

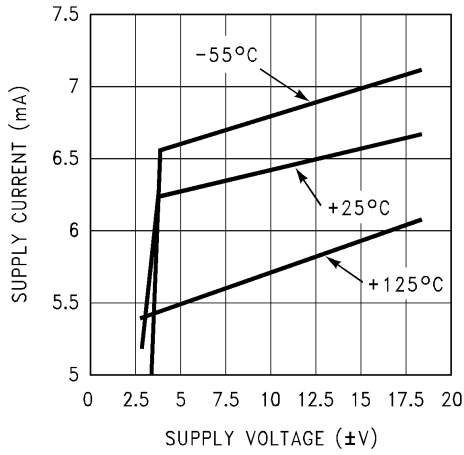

01238563

Supply Current vs. Temperature

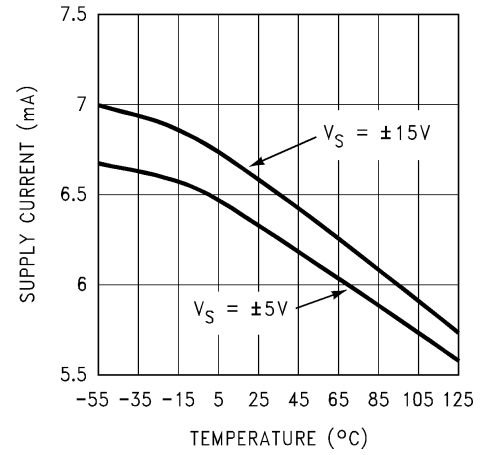

01238564

Input Offset Voltage vs. Temperature

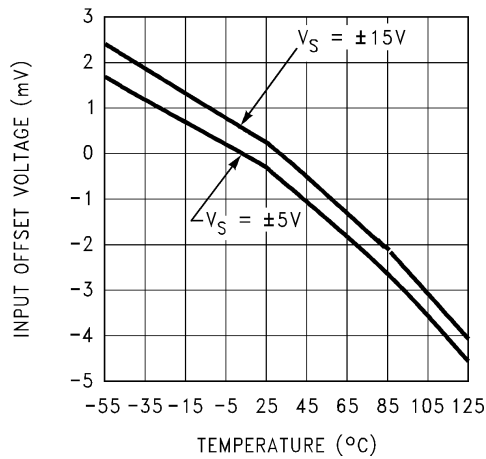

01238565

Input Bias Current vs. Temperature

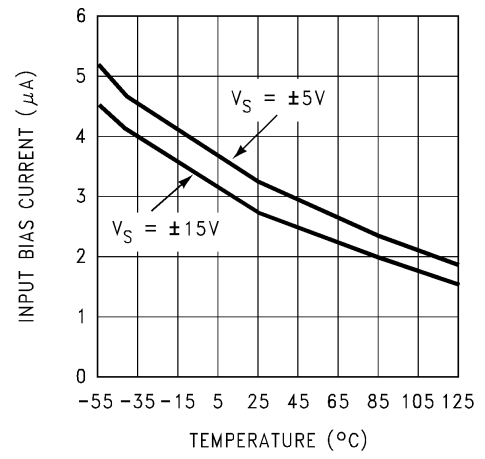

01238566

Short Circuit Current vs. Temperature (Sourcing)

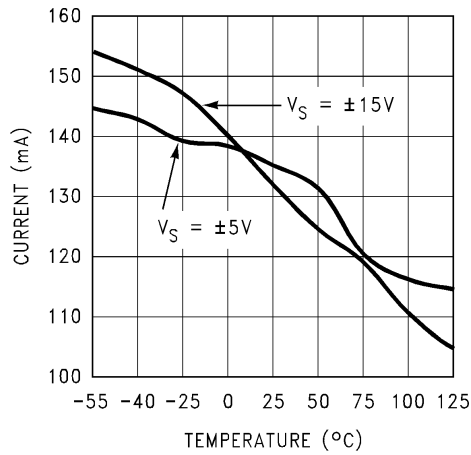

01238567

Short Circuit Current vs. Temperature (Sinking)

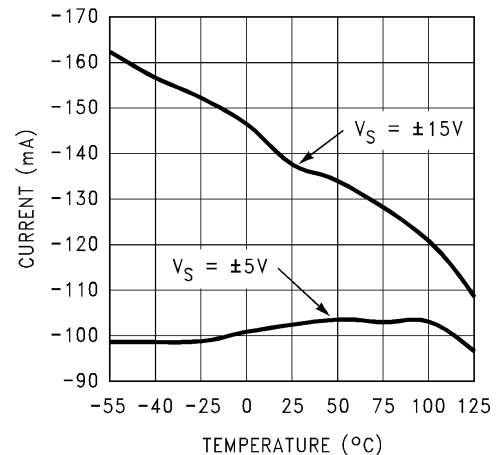

01238568

Typical Performance Characteristics unless otherwise noted, $T_A = 25^\circ\text{C}$ (Continued)

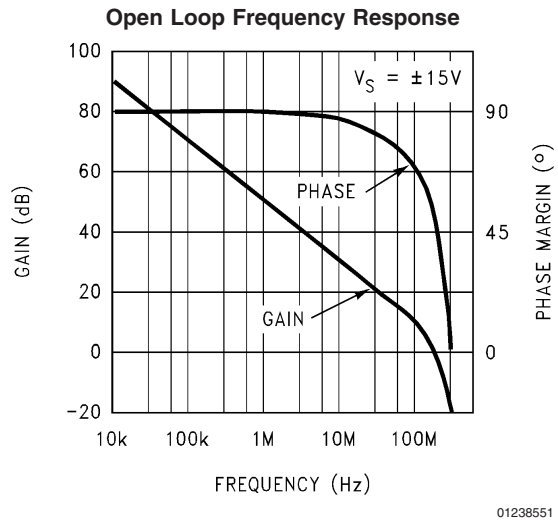
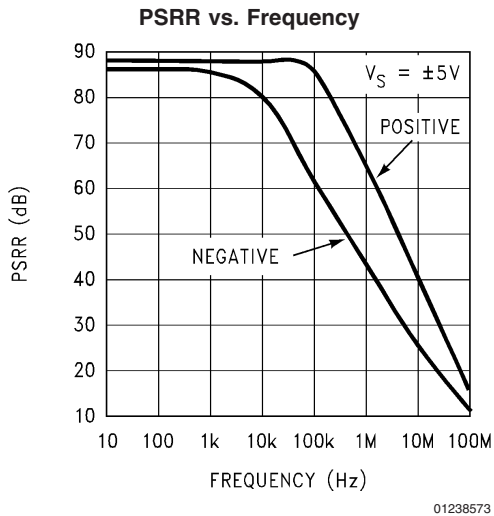
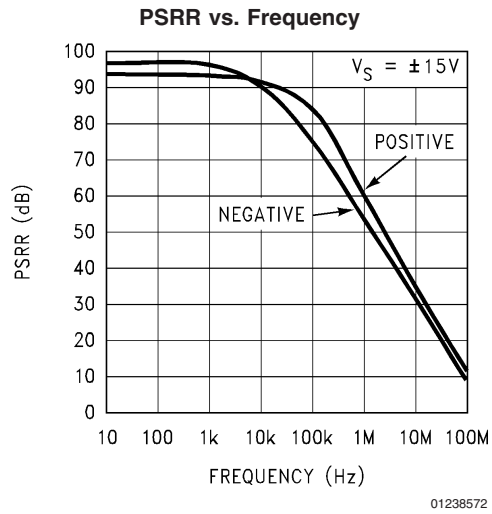
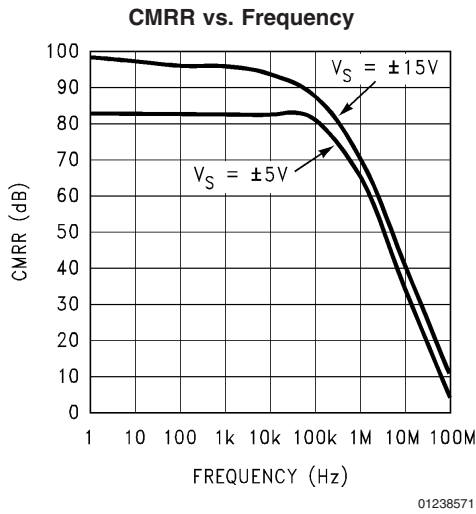
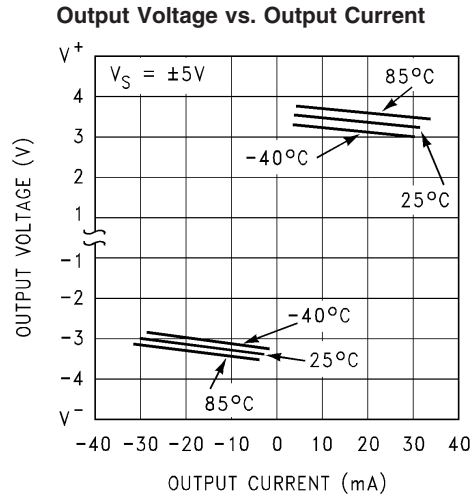
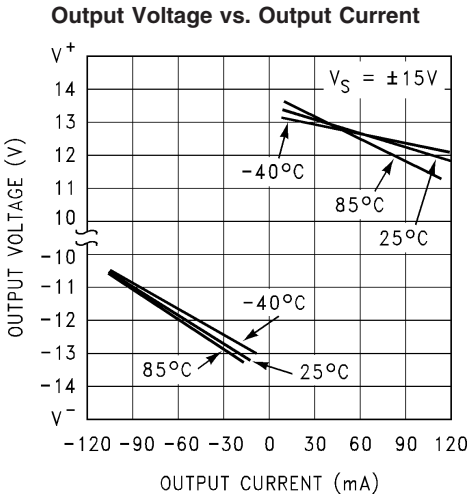

Typical Performance Characteristics unless otherwise noted, $T_A = 25^\circ\text{C}$ (Continued)

Open Loop Frequency Response

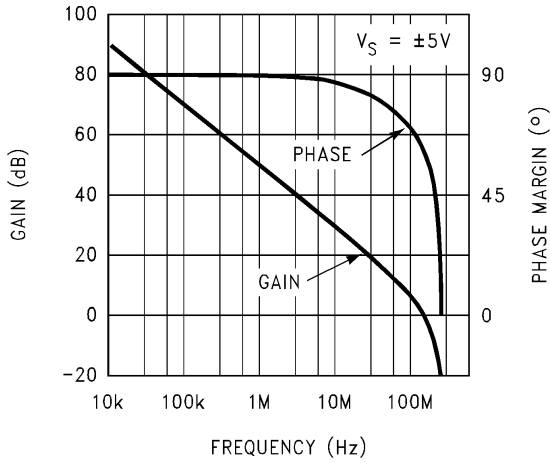

01238552

Gain-Bandwidth Product vs. Supply Voltage

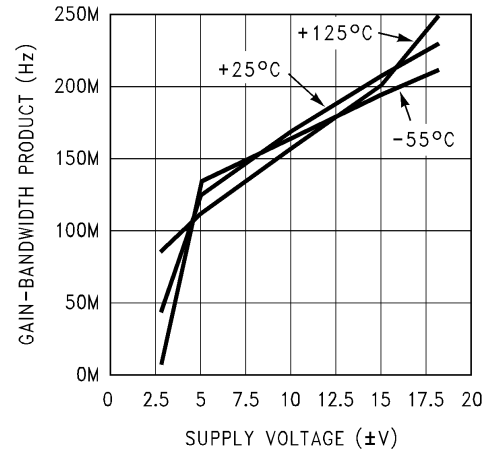

01238553

Gain-Bandwidth Product vs. Load Capacitance

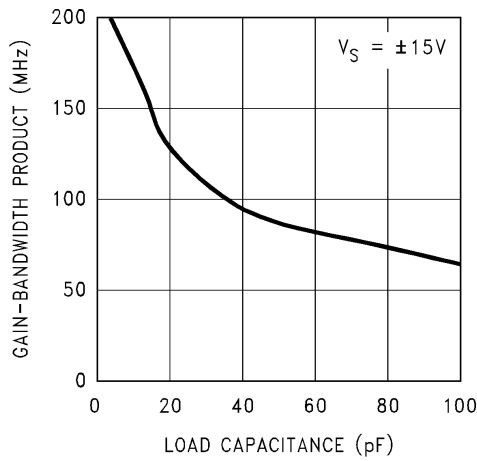

01238554

Large Signal Voltage Gain vs. Load

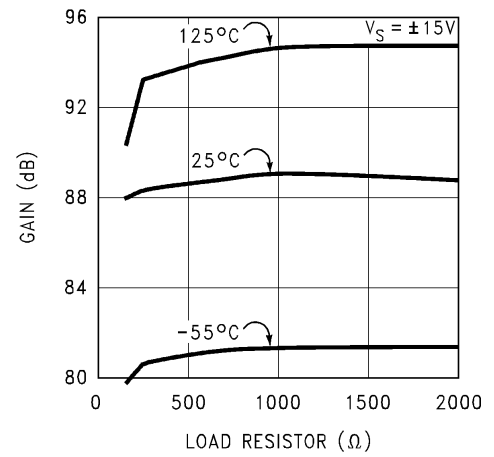

01238555

Large Signal Voltage Gain vs. Load

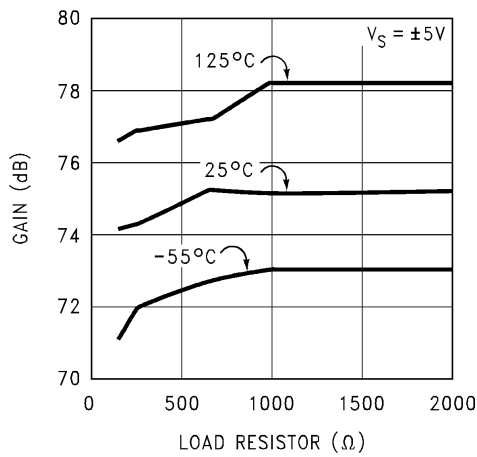

01238556

Input Voltage Noise vs. Frequency

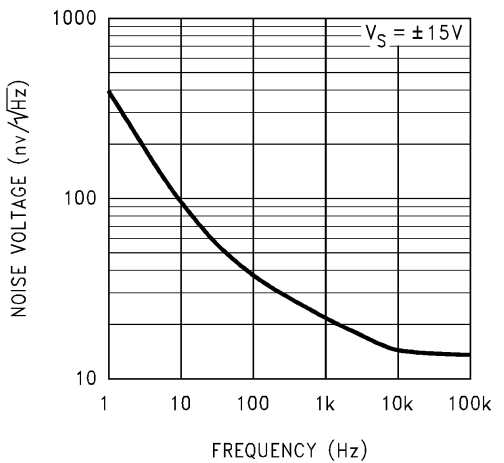

01238557

Typical Performance Characteristics unless otherwise noted, $T_A = 25^\circ\text{C}$ (Continued)

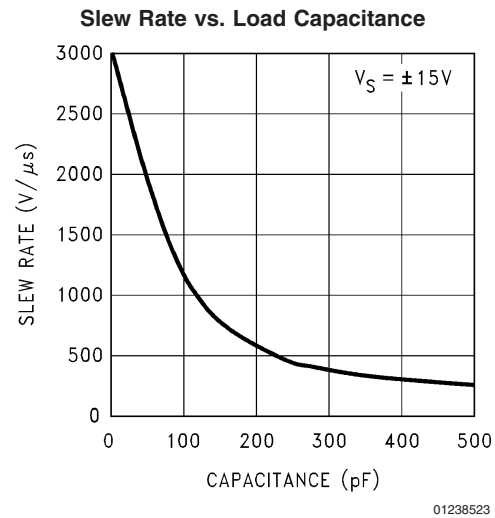
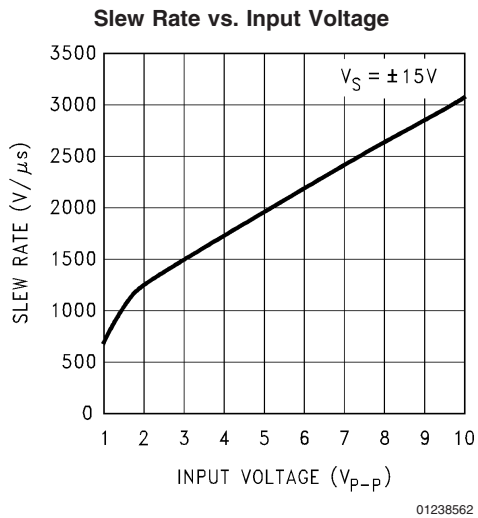
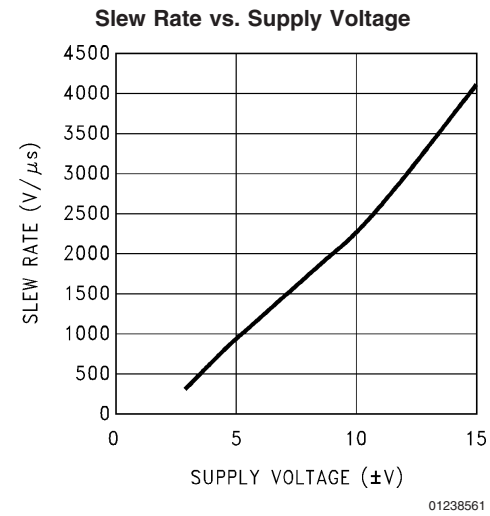
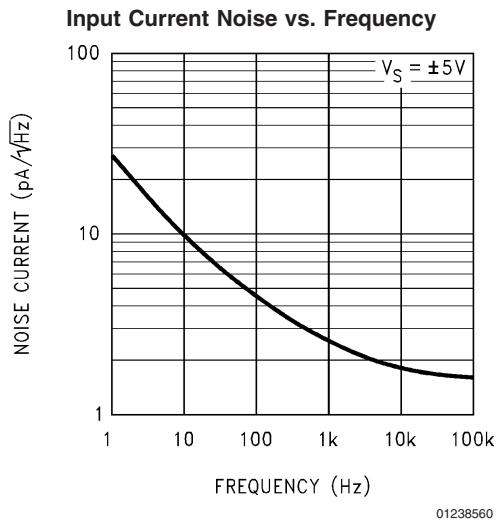
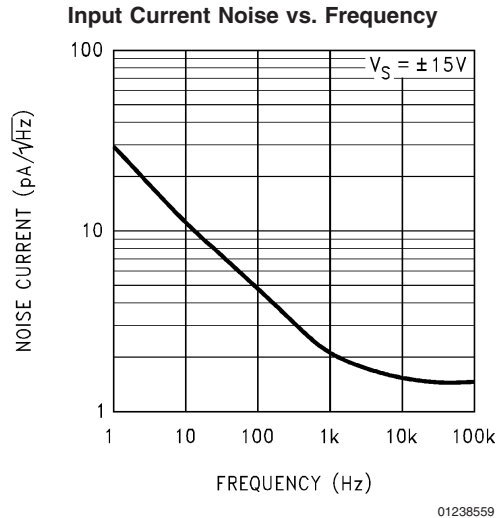
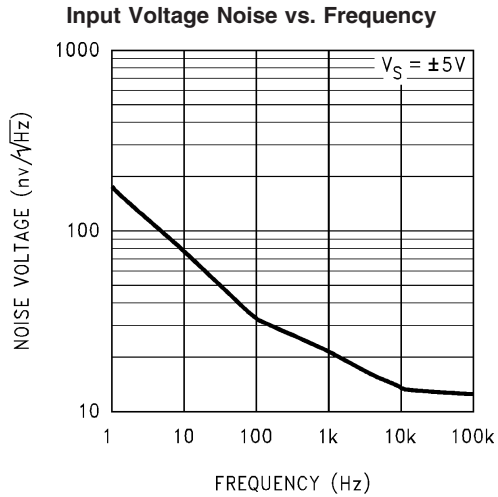

Typical Performance Characteristics unless otherwise noted, $T_A = 25^\circ\text{C}$ (Continued)

Open Loop Output Impedance vs. Frequency

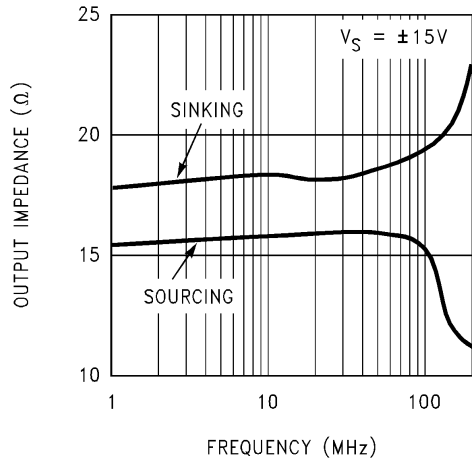

01238525

Open Loop Output Impedance vs. Frequency

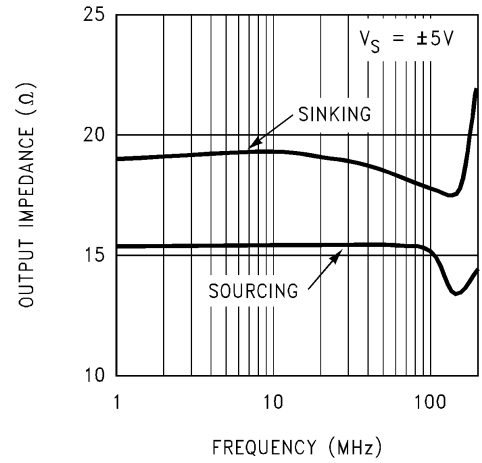

01238526

Large Signal Pulse Response
 $A_V = -1, V_S = \pm 15V$

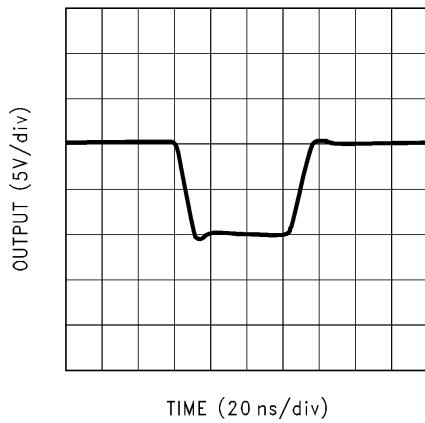

01238527

Large Signal Pulse Response
 $A_V = -1, V_S = \pm 5V$

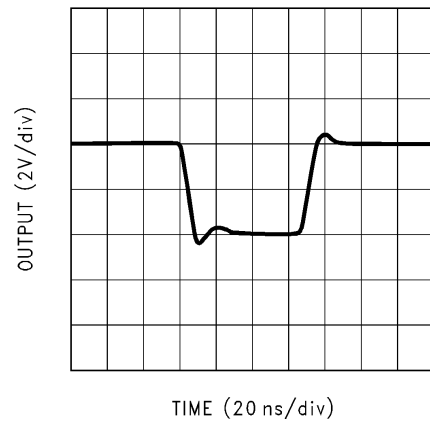

01238528

Large Signal Pulse Response
 $A_V = +2, V_S = \pm 15V$

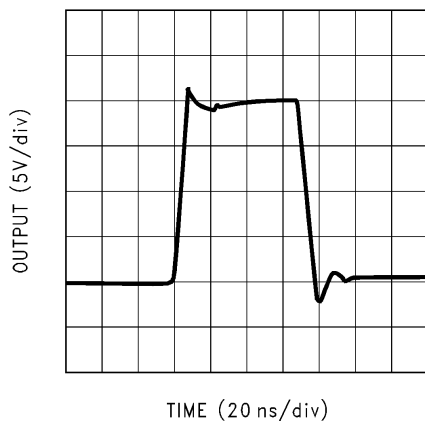

01238529

Large Signal Pulse Response
 $A_V = +2, V_S = \pm 5V$

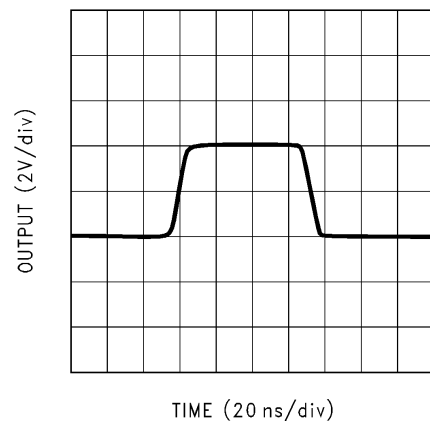

01238530

Typical Performance Characteristics unless otherwise noted, $T_A = 25^\circ\text{C}$ (Continued)

Small Signal Pulse Response
 $A_V = -1, V_S = \pm 15\text{V}$

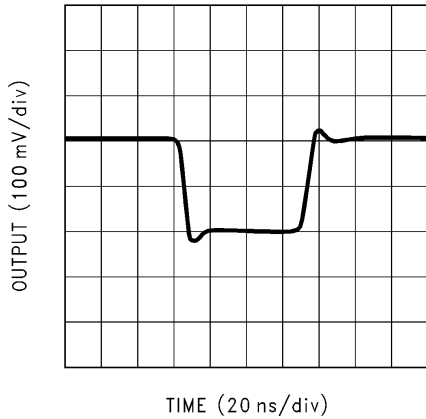

01238531

Small Signal Pulse Response
 $A_V = -1, V_S = \pm 5\text{V}$

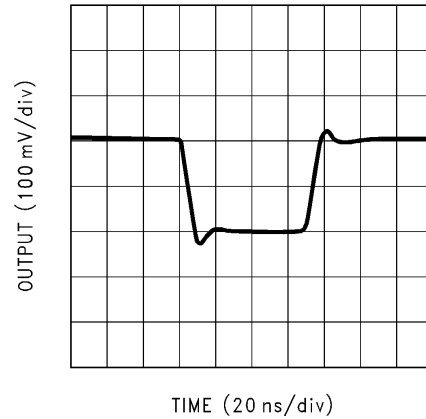

01238532

Small Signal Pulse Response
 $A_V = +2, V_S = \pm 15\text{V}$

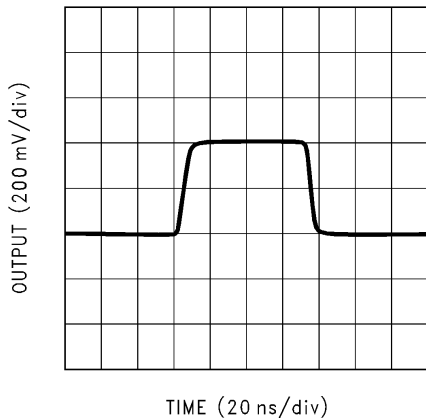

01238533

Small Signal Pulse Response
 $A_V = +2, V_S = \pm 5\text{V}$

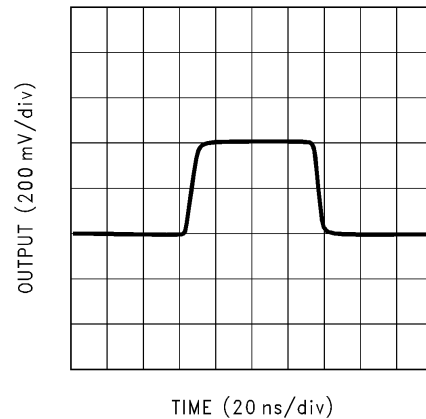

01238534

Closed Loop Frequency Response vs. Supply Voltage
 $(A_V = +2)$

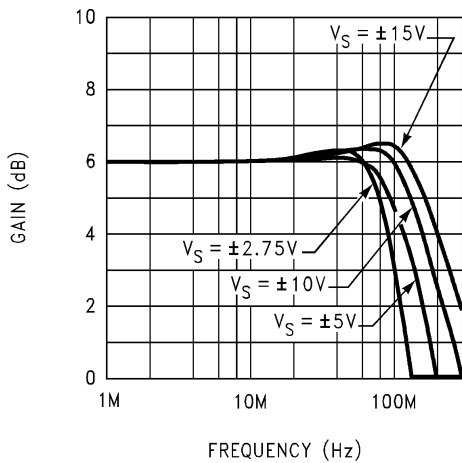

01238535

Closed Loop Frequency Response vs. Capacitive Load
 $(A_V = +2)$

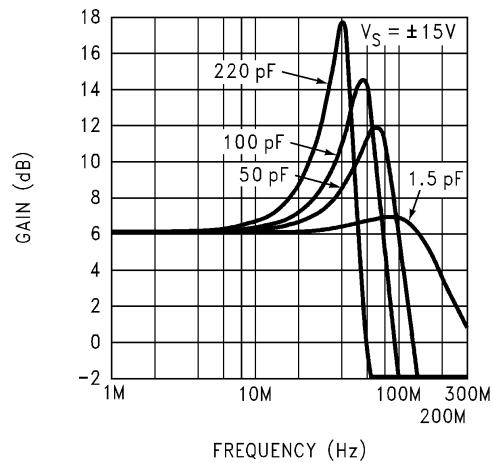

01238536

Typical Performance Characteristics unless otherwise noted, $T_A = 25^\circ\text{C}$ (Continued)

Closed Loop Frequency Response vs. Capacitive Load
($A_V = +2$)

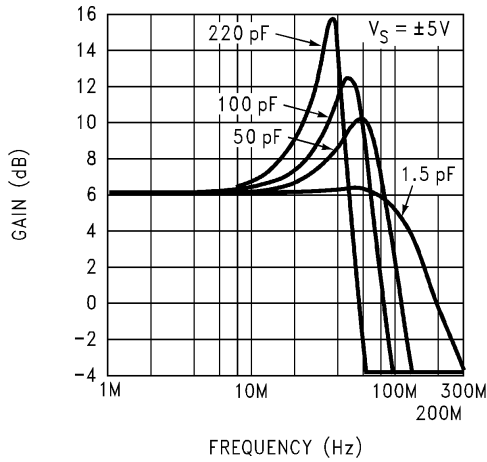

01238537

Closed Loop Frequency Response vs. Input Signal Level
($A_V = +2$)

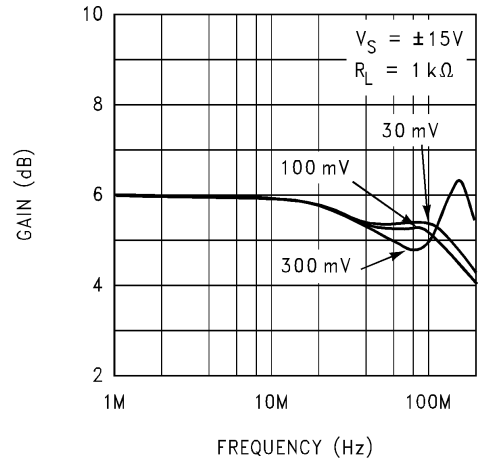

01238538

Closed Loop Frequency Response vs. Input Signal Level
($A_V = +2$)

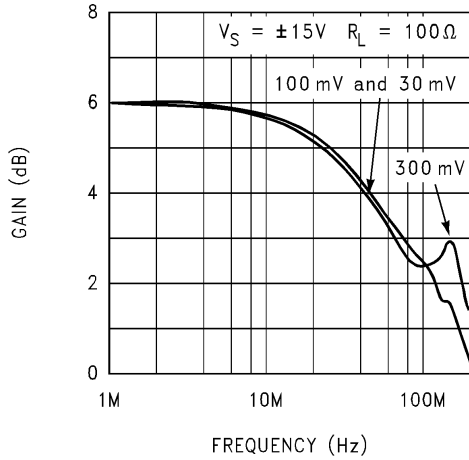

01238543

Closed Loop Frequency Response vs. Input Signal Level
($A_V = +2$)

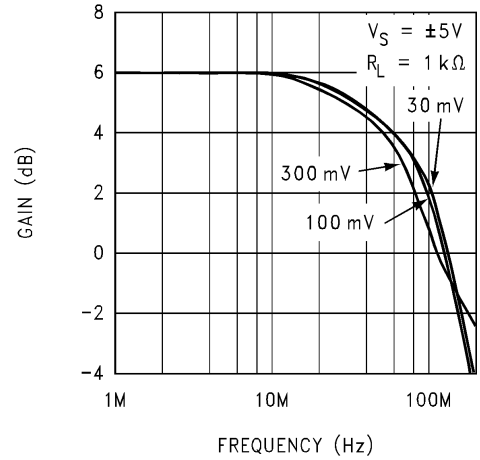

01238539

Closed Loop Frequency Response vs. Input Signal Level
($A_V = +2$)

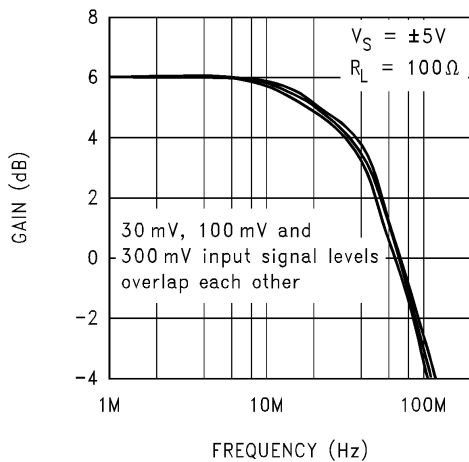

01238540

Closed Loop Frequency Response vs. Input Signal Level
($A_V = +4$)

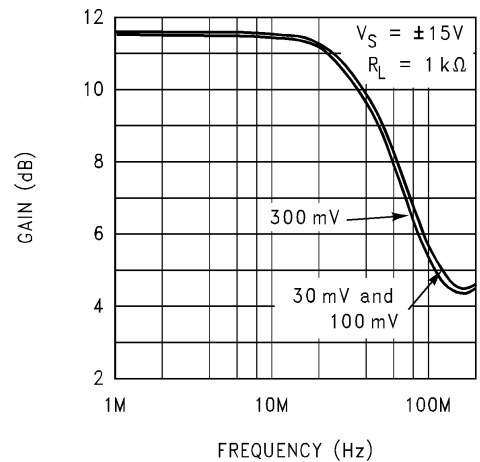

01238544

Typical Performance Characteristics unless otherwise noted, $T_A = 25^\circ\text{C}$ (Continued)

Closed Loop Frequency Response vs. Input Signal Level
($A_V = +4$)

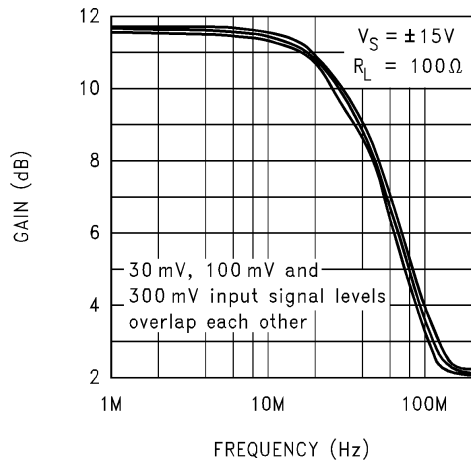

01238545

Closed Loop Frequency Response vs. Input Signal Level
($A_V = +4$)

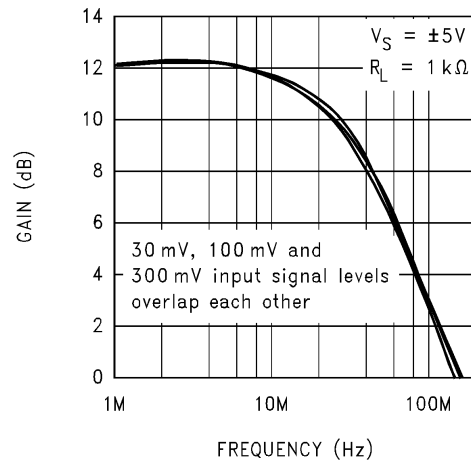

01238541

Closed Loop Frequency Response vs. Input Signal Level
($A_V = +4$)

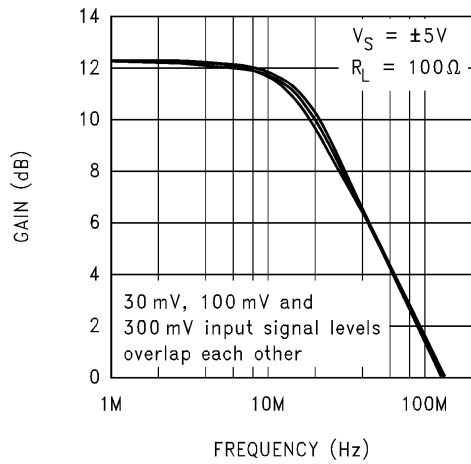

01238542

Total Harmonic Distortion vs. Frequency (Note 13)

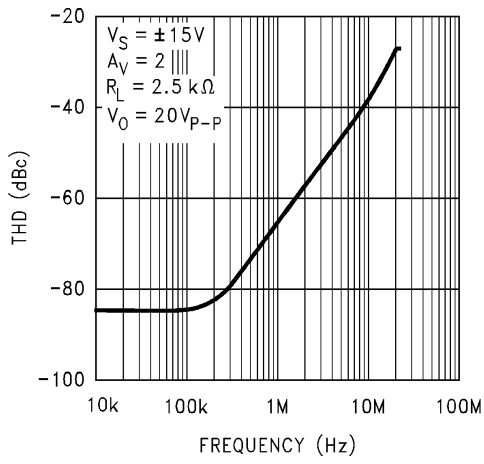

01238546

Total Harmonic Distortion vs. Frequency (Note 13)

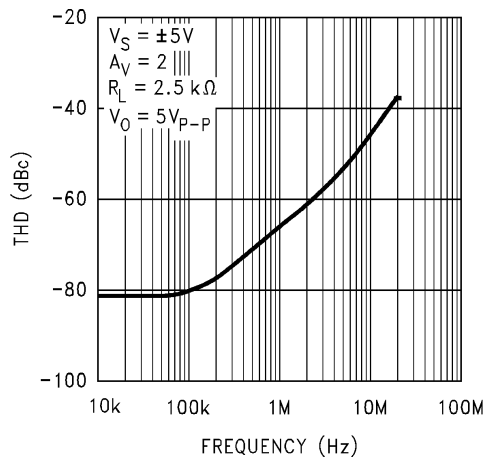

01238547

Undistorted Output Swing vs. Frequency

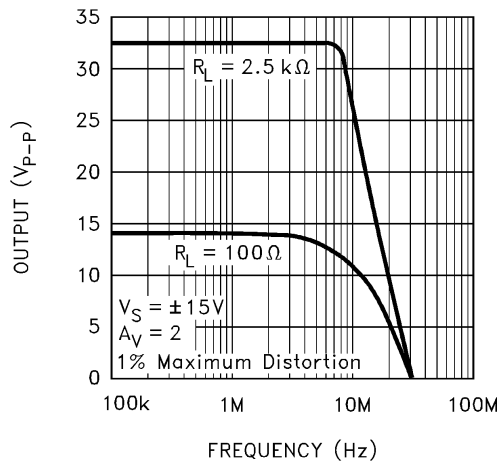

01238549

Typical Performance Characteristics unless otherwise noted, $T_A = 25^\circ\text{C}$ (Continued)

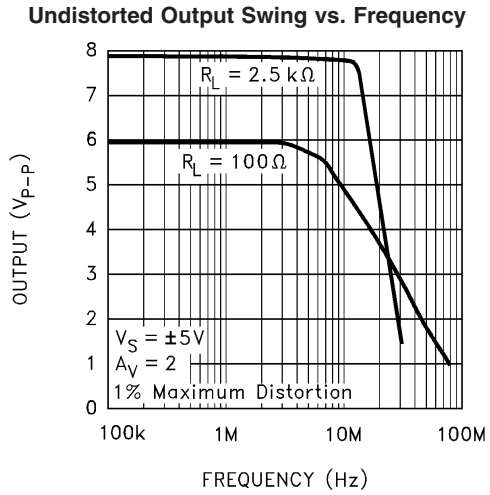

01238548

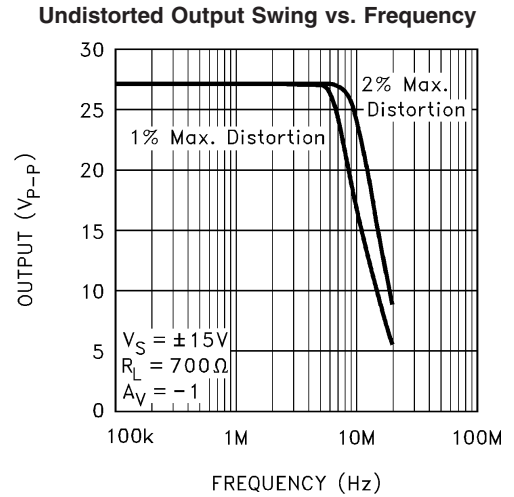

01238550

Harmonic Distortion vs. Frequency (Note 13)

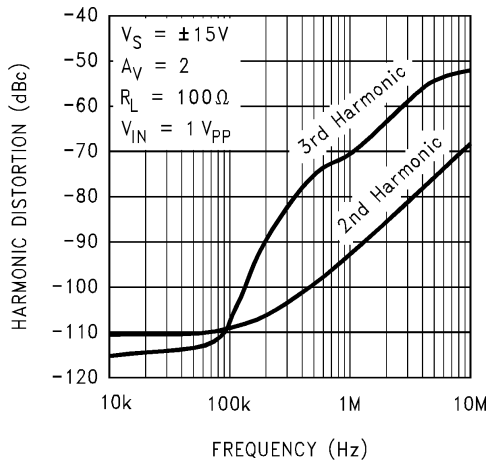

01238574

Harmonic Distortion vs. Frequency (Note 13)

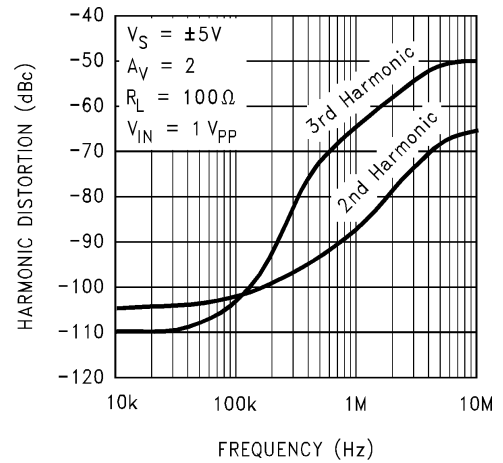

01238575

Maximum Power Dissipation vs. Ambient Temperature

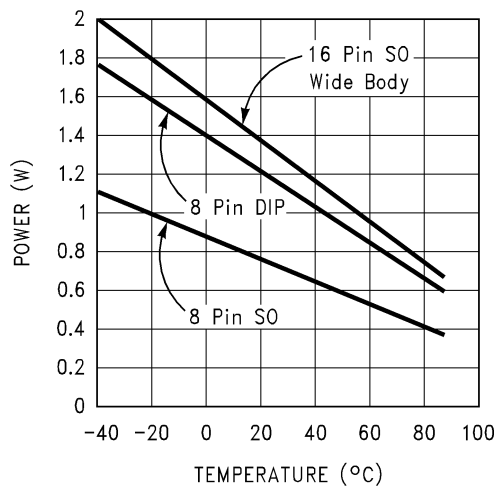

01238520

Simplified Schematic Diagram

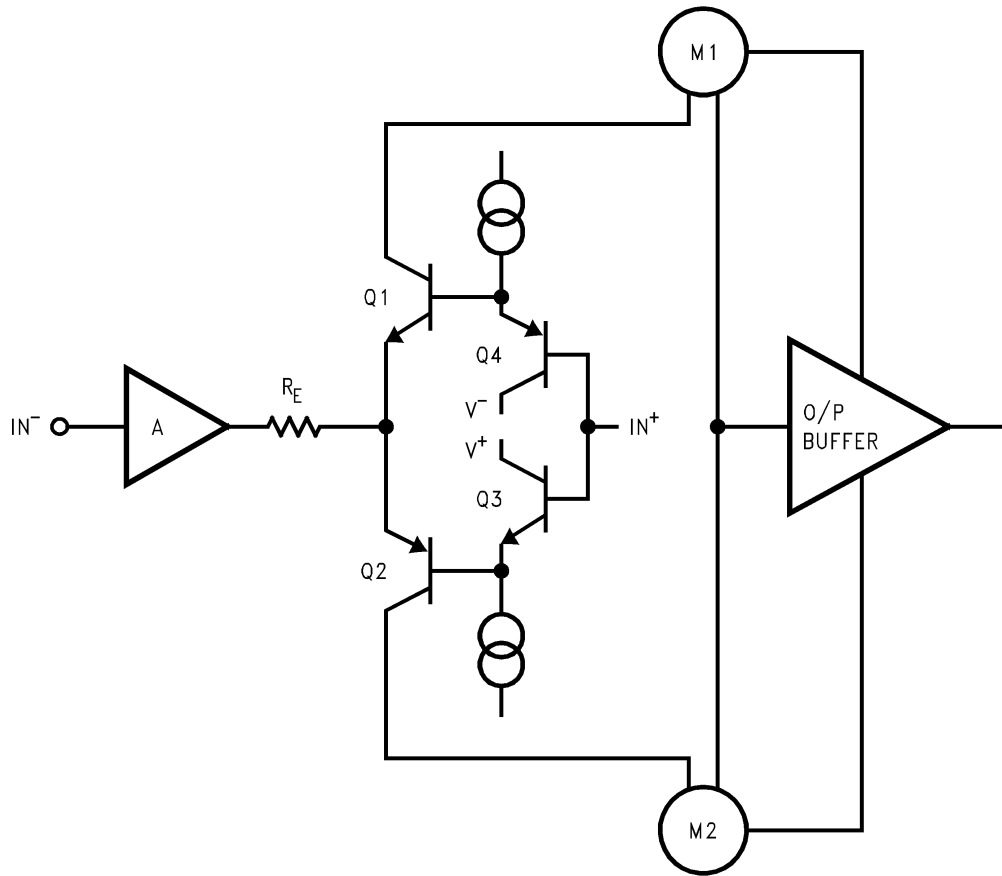

Note: M1 and M2 are current mirrors.

01238509

Application Notes

PERFORMANCE DISCUSSION

The LM7171 is a very high speed, voltage feedback amplifier. It consumes only 6.5 mA supply current while providing a unity-gain bandwidth of 200 MHz and a slew rate of 4100V/ μ s. It also has other great features such as low differential gain and phase and high output current.

The LM7171 is a true voltage feedback amplifier. Unlike current feedback amplifiers (CFAs) with a low inverting input impedance and a high non-inverting input impedance, both inputs of voltage feedback amplifiers (VFAs) have high impedance nodes. The low impedance inverting input in CFAs and a feedback capacitor create an additional pole that will lead to instability. As a result, CFAs cannot be used in traditional op amp circuits such as photodiode amplifiers, I-to-V converters and integrators where a feedback capacitor is required.

CIRCUIT OPERATION

The class AB input stage in LM7171 is fully symmetrical and has a similar slewing characteristic to the current feedback amplifiers. In the LM7171 Simplified Schematic, Q1 through Q4 form the equivalent of the current feedback input buffer, R_E the equivalent of the feedback resistor, and stage A buffers the inverting input. The triple-buffered output stage isolates the gain stage from the load to provide low output impedance.

SLEW RATE CHARACTERISTIC

The slew rate of LM7171 is determined by the current available to charge and discharge an internal high impedance node capacitor. This current is the differential input voltage divided by the total degeneration resistor R_E . Therefore, the slew rate is proportional to the input voltage level, and the higher slew rates are achievable in the lower gain configurations. A curve of slew rate versus input voltage level is provided in the "Typical Performance Characteristics".

When a very fast large signal pulse is applied to the input of an amplifier, some overshoot or undershoot occurs. By placing an external resistor such as 1 k Ω in series with the input of LM7171, the bandwidth is reduced to help lower the overshoot.

SLEW RATE LIMITATION

If the amplifier's input signal has too large of an amplitude at too high of a frequency, the amplifier is said to be slew rate limited; this can cause ringing in time domain and peaking in frequency domain at the output of the amplifier.

In the "Typical Performance Characteristics" section, there are several curves of $A_v = +2$ and $A_v = +4$ versus input signal levels. For the $A_v = +4$ curves, no peaking is present and the LM7171 responds identically to the different input signal levels of 30 mV, 100 mV and 300 mV.

For the $A_v = +2$ curves, with slight peaking occurs. This peaking at high frequency (>100 MHz) is caused by a large input signal at high enough frequency that exceeds the amplifier's slew rate. The peaking in frequency response does not limit the pulse response in time domain, and the LM7171 is stable with noise gain of $\geq +2$.

LAYOUT CONSIDERATION

Printed Circuit Board and High Speed Op Amps

There are many things to consider when designing PC boards for high speed op amps. Without proper caution, it is very easy to have excessive ringing, oscillation and other degraded AC performance in high speed circuits. As a rule, the signal traces should be short and wide to provide low inductance and low impedance paths. Any unused board space needs to be grounded to reduce stray signal pickup. Critical components should also be grounded at a common point to eliminate voltage drop. Sockets add capacitance to the board and can affect high frequency performance. It is better to solder the amplifier directly into the PC board without using any socket.

Using Probes

Active (FET) probes are ideal for taking high frequency measurements because they have wide bandwidth, high input impedance and low input capacitance. However, the probe ground leads provide a long ground loop that will produce errors in measurement. Instead, the probes can be grounded directly by removing the ground leads and probe jackets and using scope probe jacks.

Component Selection and Feedback Resistor

It is important in high speed applications to keep all component leads short. For discrete components, choose carbon composition-type resistors and mica-type capacitors. Surface mount components are preferred over discrete components for minimum inductive effect.

Large values of feedback resistors can couple with parasitic capacitance and cause undesirable effects such as ringing or oscillation in high speed amplifiers. For LM7171, a feedback resistor of 510 Ω gives optimal performance.

COMPENSATION FOR INPUT CAPACITANCE

The combination of an amplifier's input capacitance with the gain setting resistors adds a pole that can cause peaking or oscillation. To solve this problem, a feedback capacitor with a value

$$C_F > (R_G \times C_{IN})/R_F$$

can be used to cancel that pole. For LM7171, a feedback capacitor of 2 pF is recommended. Figure 1 illustrates the compensation circuit.

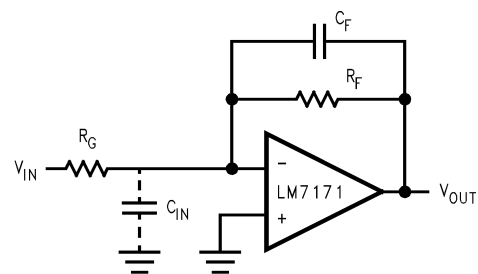

01238510

FIGURE 1. Compensating for Input Capacitance

POWER SUPPLY BYPASSING

Bypassing the power supply is necessary to maintain low power supply impedance across frequency. Both positive and negative power supplies should be bypassed individu-

Application Notes (Continued)

ally by placing 0.01 μF ceramic capacitors directly to power supply pins and 2.2 μF tantalum capacitors close to the power supply pins.

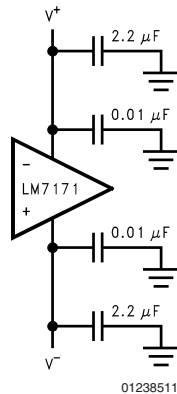

FIGURE 2. Power Supply Bypassing

TERMINATION

In high frequency applications, reflections occur if signals are not properly terminated. Figure 3 shows a properly terminated signal while Figure 4 shows an improperly terminated signal.

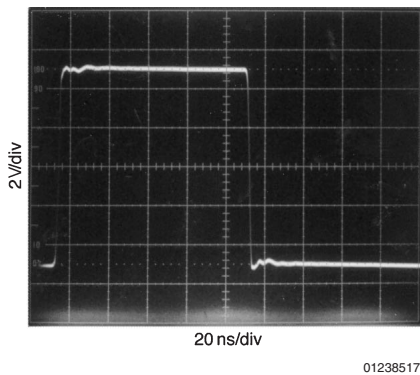

FIGURE 3. Properly Terminated Signal

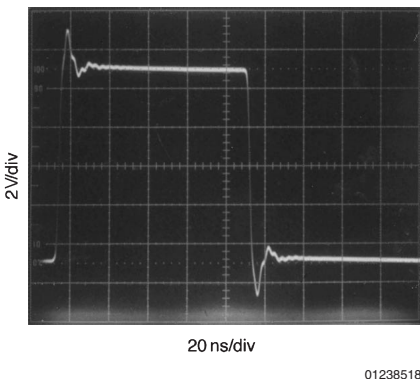

FIGURE 4. Improperly Terminated Signal

To minimize reflection, coaxial cable with matching characteristic impedance to the signal source should be used. The other end of the cable should be terminated with the same value terminator or resistor. For the commonly used cables, RG59 has 75 Ω characteristic impedance, and RG58 has 50 Ω characteristic impedance.

DRIVING CAPACITIVE LOADS

Amplifiers driving capacitive loads can oscillate or have ringing at the output. To eliminate oscillation or reduce ringing, an isolation resistor can be placed as shown below in Figure 5. The combination of the isolation resistor and the load capacitor forms a pole to increase stability by adding more phase margin to the overall system. The desired performance depends on the value of the isolation resistor; the bigger the isolation resistor, the more damped the pulse response becomes. For LM7171, a 50 Ω isolation resistor is recommended for initial evaluation. Figure 6 shows the LM7171 driving a 150 pF load with the 50 Ω isolation resistor.

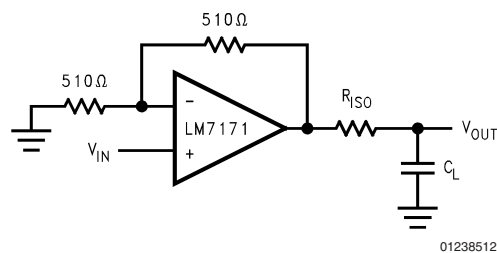

FIGURE 5. Isolation Resistor Used to Drive Capacitive Load

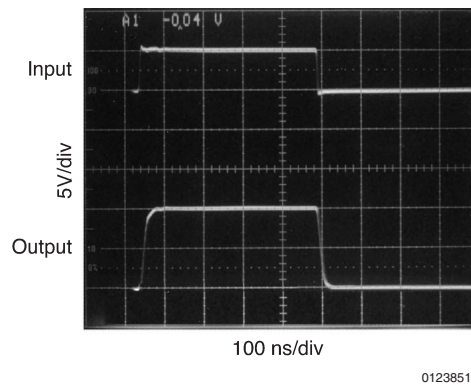

FIGURE 6. The LM7171 Driving a 150 pF Load with a 50 Ω Isolation Resistor

POWER DISSIPATION

The maximum power allowed to dissipate in a device is defined as:

$$P_D = (T_{J(\text{MAX})} - T_A) / \theta_{JA}$$

Where

- PD is the power dissipation in a device
- $T_{J(\text{max})}$ is the maximum junction temperature
- T_A is the ambient temperature
- θ_{JA} is the thermal resistance of a particular package

For example, for the LM7171 in a SO-8 package, the maximum power dissipation at 25 $^{\circ}\text{C}$ ambient temperature is 730 mW.

Application Notes (Continued)

Thermal resistance, θ_{JA} , depends on parameters such as die size, package size and package material. The smaller the die size and package, the higher θ_{JA} becomes. The 8-pin DIP package has a lower thermal resistance (108°C/W) than that of 8-pin SO (172°C/W). Therefore, for higher dissipation capability, use an 8-pin DIP package.

The total power dissipated in a device can be calculated as:

$$P_D = P_Q + P_L$$

P_Q is the quiescent power dissipated in a device with no load connected at the output. P_L is the power dissipated in the device with a load connected at the output; it is not the power dissipated by the load.

Furthermore,

P_Q : = supply current x total supply voltage with no load

P_L : = output current x (voltage difference between supply voltage and output voltage of the same side of supply voltage)

For example, the total power dissipated by the LM7171 with $V_S = \pm 15\text{V}$ and output voltage of 10V into $1\text{ k}\Omega$ is

$$\begin{aligned} P_D &= P_Q + P_L \\ &= (6.5\text{ mA}) \times (30\text{V}) + (10\text{ mA}) \times (15\text{V} - 10\text{V}) \\ &= 195\text{ mW} + 50\text{ mW} \\ &= 245\text{ mW} \end{aligned}$$

Application Circuit

Fast Instrumentation Amplifier

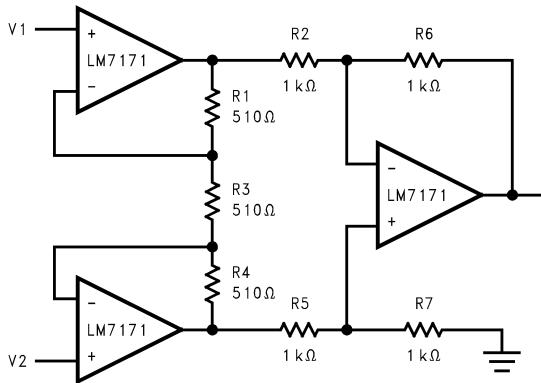

01238514

$$\begin{aligned} V_{IN} &= V_2 - V_1 \\ \text{if } R_6 &= R_2, R_7 = R_5, \text{ and } R_1 = R_4 \\ \frac{V_{OUT}}{V_{IN}} &= \frac{R_6}{R_2} \left(1 + 2 \frac{R_1}{R_3} \right) = 3 \end{aligned}$$

01238580

Multivibrator

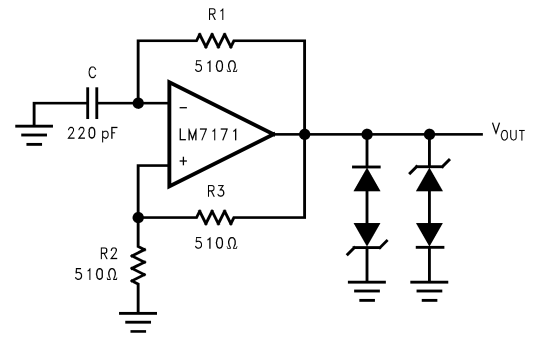

01238515

$$\begin{aligned} f &= \frac{1}{2 \left(R_1 C \ln \left(1 + 2 \frac{R_2}{R_3} \right) \right)} \\ f &= 4\text{ MHz} \end{aligned}$$

01238581

Pulse Width Modulator

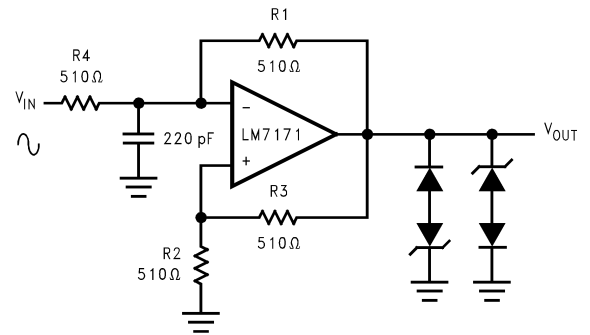

01238516

Video Line Driver

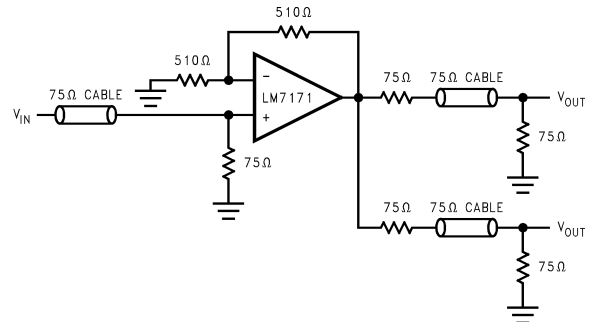

01238521

Physical Dimensions inches (millimeters) unless otherwise noted

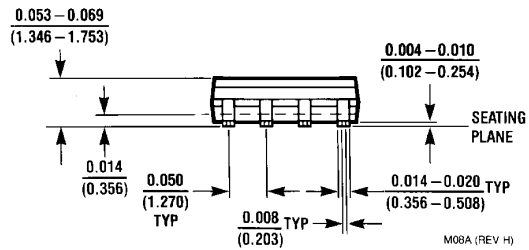
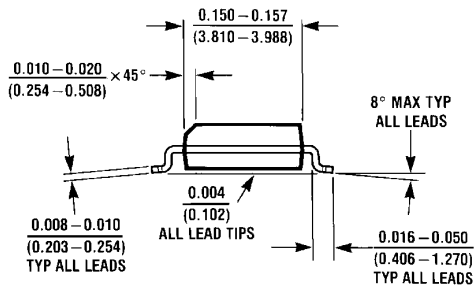
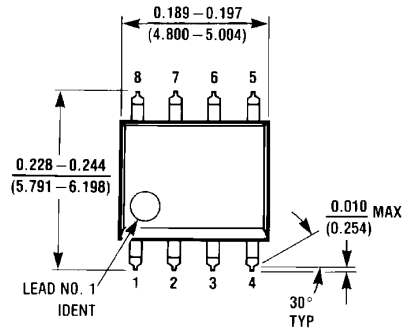

8-Pin SOIC
NS Package Number M08A

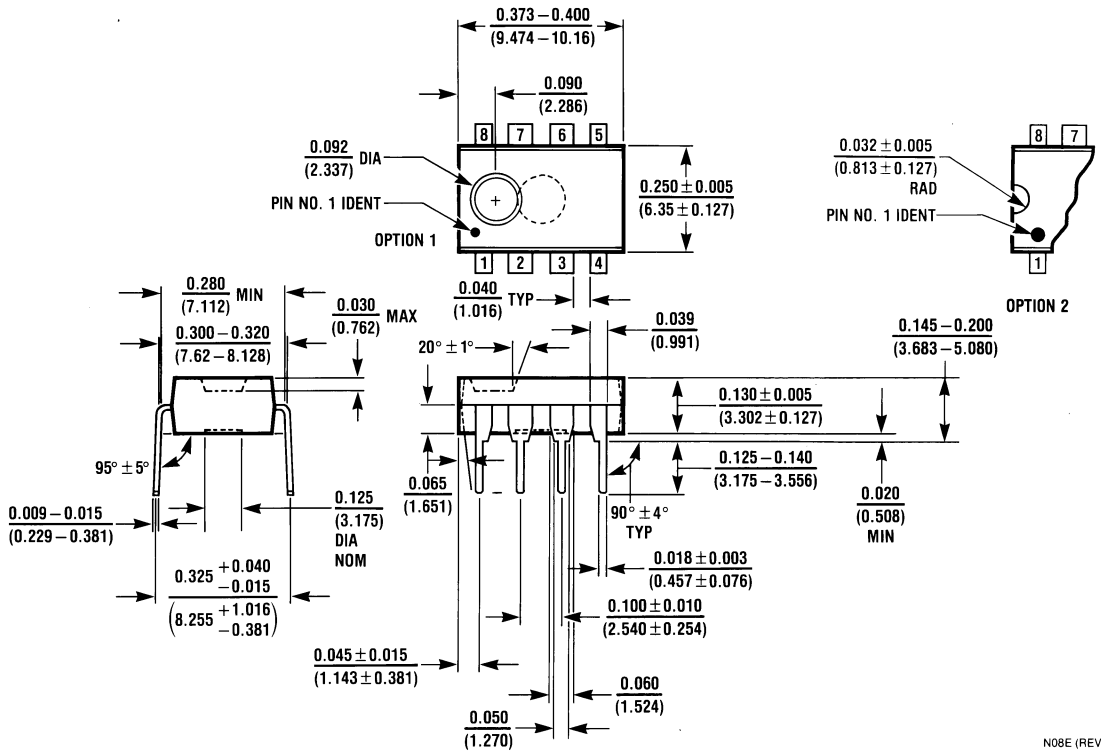

8-Pin MDIP
NS Package Number N08E

Notes

National does not assume any responsibility for use of any circuitry described, no circuit patent licenses are implied and National reserves the right at any time without notice to change said circuitry and specifications.

For the most current product information visit us at www.national.com.

LIFE SUPPORT POLICY

NATIONAL'S PRODUCTS ARE NOT AUTHORIZED FOR USE AS CRITICAL COMPONENTS IN LIFE SUPPORT DEVICES OR SYSTEMS WITHOUT THE EXPRESS WRITTEN APPROVAL OF THE PRESIDENT AND GENERAL COUNSEL OF NATIONAL SEMICONDUCTOR CORPORATION. As used herein:

1. Life support devices or systems are devices or systems which, (a) are intended for surgical implant into the body, or (b) support or sustain life, and whose failure to perform when properly used in accordance with instructions for use provided in the labeling, can be reasonably expected to result in a significant injury to the user.
2. A critical component is any component of a life support device or system whose failure to perform can be reasonably expected to cause the failure of the life support device or system, or to affect its safety or effectiveness.

BANNED SUBSTANCE COMPLIANCE

National Semiconductor follows the provisions of the Product Stewardship Guide for Customers (CSP-9-111C2) and Banned Substances and Materials of Interest Specification (CSP-9-111S2) for regulatory environmental compliance. Details may be found at: www.national.com/quality/green.

Lead free products are RoHS compliant.



National Semiconductor
Americas Customer
Support Center
Email: new.feedback@nsc.com
Tel: 1-800-272-9959

www.national.com

National Semiconductor
Europe Customer Support Center
Fax: +49 (0) 180-530 85 86
Email: europa.support@nsc.com
Deutsch Tel: +49 (0) 69 9508 6208
English Tel: +44 (0) 870 24 0 2171
Français Tel: +33 (0) 1 41 91 8790

National Semiconductor
Asia Pacific Customer
Support Center
Email: ap.support@nsc.com

National Semiconductor
Japan Customer Support Center
Fax: 81-3-5639-7507
Email: jpn.feedback@nsc.com
Tel: 81-3-5639-7560

IMPORTANT NOTICE

Texas Instruments Incorporated and its subsidiaries (TI) reserve the right to make corrections, modifications, enhancements, improvements, and other changes to its products and services at any time and to discontinue any product or service without notice. Customers should obtain the latest relevant information before placing orders and should verify that such information is current and complete. All products are sold subject to TI's terms and conditions of sale supplied at the time of order acknowledgment.

TI warrants performance of its hardware products to the specifications applicable at the time of sale in accordance with TI's standard warranty. Testing and other quality control techniques are used to the extent TI deems necessary to support this warranty. Except where mandated by government requirements, testing of all parameters of each product is not necessarily performed.

TI assumes no liability for applications assistance or customer product design. Customers are responsible for their products and applications using TI components. To minimize the risks associated with customer products and applications, customers should provide adequate design and operating safeguards.

TI does not warrant or represent that any license, either express or implied, is granted under any TI patent right, copyright, mask work right, or other TI intellectual property right relating to any combination, machine, or process in which TI products or services are used. Information published by TI regarding third-party products or services does not constitute a license from TI to use such products or services or a warranty or endorsement thereof. Use of such information may require a license from a third party under the patents or other intellectual property of the third party, or a license from TI under the patents or other intellectual property of TI.

Reproduction of TI information in TI data books or data sheets is permissible only if reproduction is without alteration and is accompanied by all associated warranties, conditions, limitations, and notices. Reproduction of this information with alteration is an unfair and deceptive business practice. TI is not responsible or liable for such altered documentation. Information of third parties may be subject to additional restrictions.

Resale of TI products or services with statements different from or beyond the parameters stated by TI for that product or service voids all express and any implied warranties for the associated TI product or service and is an unfair and deceptive business practice. TI is not responsible or liable for any such statements.

TI products are not authorized for use in safety-critical applications (such as life support) where a failure of the TI product would reasonably be expected to cause severe personal injury or death, unless officers of the parties have executed an agreement specifically governing such use. Buyers represent that they have all necessary expertise in the safety and regulatory ramifications of their applications, and acknowledge and agree that they are solely responsible for all legal, regulatory and safety-related requirements concerning their products and any use of TI products in such safety-critical applications, notwithstanding any applications-related information or support that may be provided by TI. Further, Buyers must fully indemnify TI and its representatives against any damages arising out of the use of TI products in such safety-critical applications.

TI products are neither designed nor intended for use in military/aerospace applications or environments unless the TI products are specifically designated by TI as military-grade or "enhanced plastic." Only products designated by TI as military-grade meet military specifications. Buyers acknowledge and agree that any such use of TI products which TI has not designated as military-grade is solely at the Buyer's risk, and that they are solely responsible for compliance with all legal and regulatory requirements in connection with such use.

TI products are neither designed nor intended for use in automotive applications or environments unless the specific TI products are designated by TI as compliant with ISO/TS 16949 requirements. Buyers acknowledge and agree that, if they use any non-designated products in automotive applications, TI will not be responsible for any failure to meet such requirements.

Following are URLs where you can obtain information on other Texas Instruments products and application solutions:

Products

Audio	www.ti.com/audio
Amplifiers	amplifier.ti.com
Data Converters	dataconverter.ti.com
DLP® Products	www.dlp.com
DSP	dsp.ti.com
Clocks and Timers	www.ti.com/clocks
Interface	interface.ti.com
Logic	logic.ti.com
Power Mgmt	power.ti.com
Microcontrollers	microcontroller.ti.com
RFID	www.ti-rfid.com
OMAP Mobile Processors	www.ti.com/omap
Wireless Connectivity	www.ti.com/wirelessconnectivity

Applications

Communications and Telecom	www.ti.com/communications
Computers and Peripherals	www.ti.com/computers
Consumer Electronics	www.ti.com/consumer-apps
Energy and Lighting	www.ti.com/energy
Industrial	www.ti.com/industrial
Medical	www.ti.com/medical
Security	www.ti.com/security
Space, Avionics and Defense	www.ti.com/space-avionics-defense
Transportation and Automotive	www.ti.com/automotive
Video and Imaging	www.ti.com/video

TI E2E Community Home Page

e2e.ti.com

Mailing Address: Texas Instruments, Post Office Box 655303, Dallas, Texas 75265
Copyright © 2011, Texas Instruments Incorporated







Looking for pricing, stock, or lifecycle information?

Click below to explore more details on WIN SOURCE:

 [View LM7171AIN/NOPB on WIN SOURCE](#)

 [Texas Instruments](#) Information

Optimize Your Supply Chain with WIN SOURCE Solutions

-  Global Sourcing Solution
-  Obsolete Management
-  Cost Control Management
-  Shortage Management
-  Alternative Solution
-  Excess Inventory Management