



**THE DATASHEET OF
ESD205B102ELE6327XTMA1**



Protection Device

TVS (Transient Voltage Suppressor)

ESD205-B1 Series

Bi-directional, 5.5 V, 5 pF, 0201, 0402, RoHS and Halogen Free compliant

ESD205-B1-02ELS
ESD205-B1-02EL

Data Sheet

Revision 1.4, 2014-05-14
Final

Edition 2014-05-14

Published by

Infineon Technologies AG

81726 Munich, Germany

© 2014 Infineon Technologies AG

All Rights Reserved.

Information

For further information on technology, delivery terms and conditions and prices, please contact the nearest Infineon Technologies Office (www.infineon.com)

Warnings

Due to technical requirements, components may contain dangerous substances. For information on the types in question, please contact the nearest Infineon Technologies Office.

Infineon Technologies components may be used in life-support devices or systems only with the express written approval of Infineon Technologies, if a failure of such components can reasonably be expected to cause the failure of that life-support device or system or to affect the safety or effectiveness of that device or system. Life support devices or systems are intended to be implanted in the human body or to support and/or maintain and sustain and/or protect human life. If they fail, it is reasonable to assume that the health of the user or other persons may be endangered.

1 Product Overview

1.1 Features

- ESD / transient protection of signal lines in low voltage applications according to:
 - IEC61000-4-2 (ESD): ± 20 kV (air / contact)
 - IEC61000-4-4 (EFT): ± 2.5 kV / ± 50 A (5/50 ns)
 - IEC61000-4-5 (Surge): ± 2.5 A (8/20 μ s)
- Bi-directional, working voltage up to $V_{RWM} = \pm 5.5$ V
- Low capacitance: $C_L = 5$ pF (typical)
- Low clamping voltage: $V_{CL} = +10 / -12$ V (typical) at $I_{TLP} = 16$ A
- Very low reverse current: $I_R < 1$ nA (typical)
- Pb-free (RoHS compliant) and halogen free package



1.2 Application Examples

- Keypad, touchpad, buttons, convenience keys
- LCD displays, Camera, audio lines, mobile communication, Consumer products (E-Book, MP3, DVD, DSC...)
- Notebooks tablets and desktop computers and their peripherals

1.3 Product Description

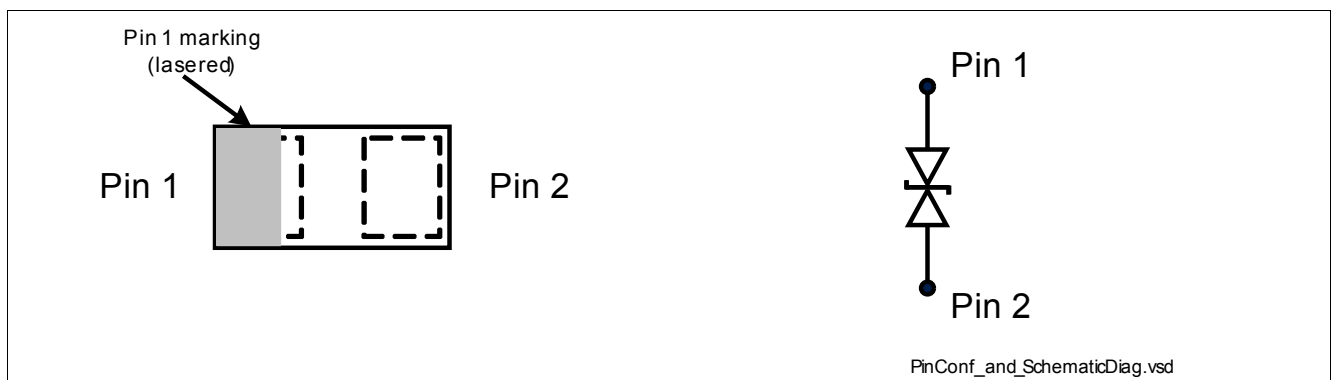

Figure 1-1 Pin Configuration and Schematic Diagram

Table 1-1 Ordering Information

Type	Package	Configuration	Marking code
ESD205-B1-02ELS	TSSLP-2-3	1 line, bi-directional	
ESD205-B1-02EL	TSLP-2-19	1 line, bi-directional	

2 Maximum Ratings

Table 2-1 Maximum Ratings at $T_A = 25\text{ }^\circ\text{C}$, unless otherwise specified

Parameter	Symbol	Values	Unit
ESD air discharge ¹⁾	V_{ESD}	± 20	kV
ESD contact discharge ¹⁾		± 20	
Peak pulse power ²⁾	P_{PK}	30	W
Peak pulse current ²⁾	I_{PP}	± 2.5	A
Operating temperature range	T_{OP}	-55 to 125	$^\circ\text{C}$
Storage temperature	T_{stg}	-65 to 150	$^\circ\text{C}$

1) V_{ESD} according to IEC61000-4-2

2) Non-repetitive current pulse 8/20 μs exponential decay waveform according to IEC61000-4-5

Attention: Stresses above the max. values listed here may cause permanent damage to the device. Exposure to absolute maximum rating conditions for extended periods may affect device reliability. Maximum ratings are absolute ratings; exceeding only one of these values may cause irreversible damage to the integrated circuit.

3 Electrical Characteristics at $T_A = 25\text{ }^\circ\text{C}$, unless otherwise specified

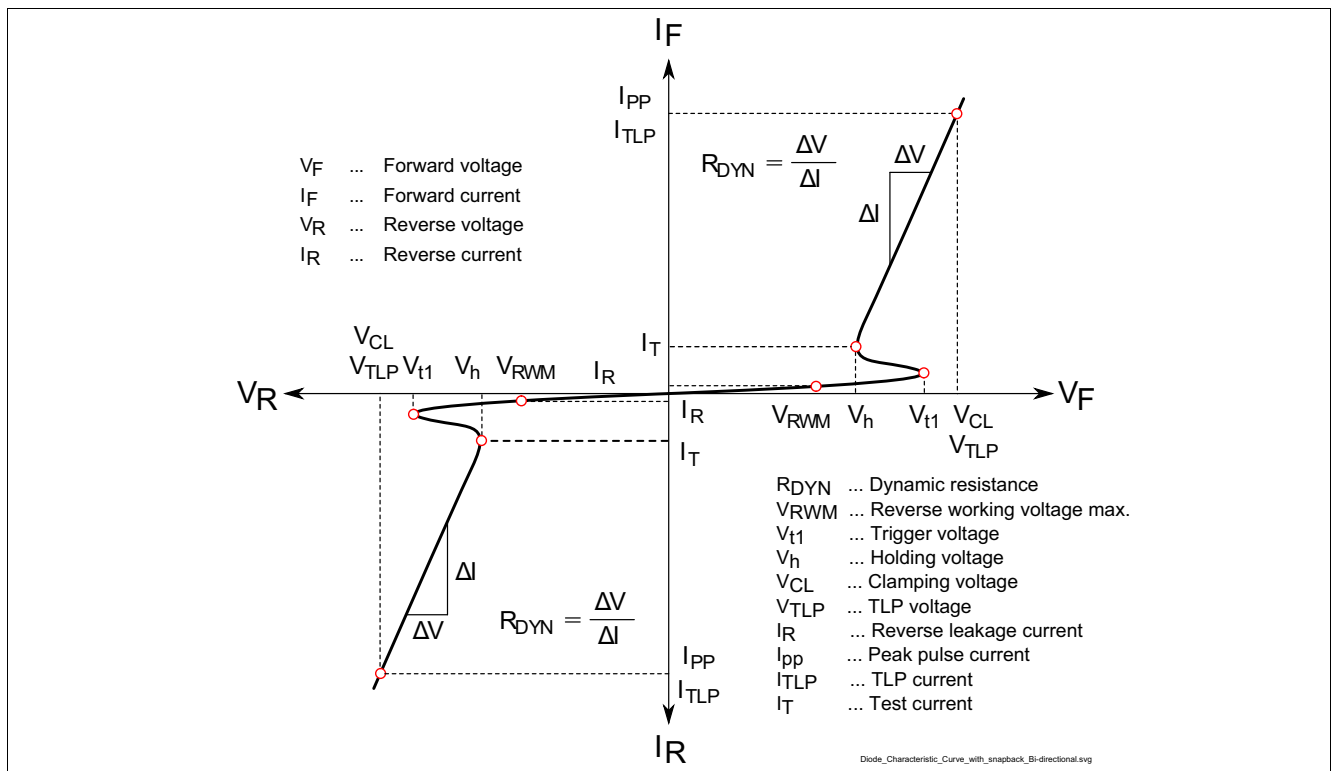

Figure 3-1 Definitions of electrical characteristics

Electrical Characteristics at $T_A = 25\text{ }^\circ\text{C}$, unless otherwise specified
Table 3-1 DC Characteristics at $T_A = 25\text{ }^\circ\text{C}$, unless otherwise specified

Parameter	Symbol	Values			Unit	Note / Test Condition
		Min.	Typ.	Max.		
Reverse working voltage	V_{RWM}	-5.5	–	5.5	V	
Trigger voltage	V_{t1}	6	–	–	V	
Holding voltage	V_h	6	8	10	V	$I_T = 1\text{ mA}$
Reverse current	I_R	–	<1	100	nA	$V_R = 5.5\text{ V}$

Table 3-2 AC Characteristics at $T_A = 25\text{ }^\circ\text{C}$, unless otherwise specified

Parameter	Symbol	Values			Unit	Note / Test Condition
		Min.	Typ.	Max.		
Line capacitance	C_L	4 –	5 5	7 –	pF	$V_R = 0\text{ V}, f = 1\text{ MHz}$ $V_R = 0\text{ V}, f = 1\text{ GHz}$
Series inductance	L_S	– –	0.2 0.4	– –	nH	ESD205-B1-02ELS ESD205-B1-02EL

Table 3-3 ESD and Surge Characteristics at $T_A = 25\text{ }^\circ\text{C}$, unless otherwise specified

Parameter	Symbol	Values			Unit	Note / Test Condition
		Min.	Typ.	Max.		
Clamping voltage ¹⁾	V_{CL}	–	10	–	V	$I_{TLP} = 16\text{ A}, t_p = 100\text{ ns}$ from Pin 1 to Pin 2
		–	13	–		$I_{TLP} = 30\text{ A}, t_p = 100\text{ ns}$ from Pin 1 to Pin 2
		–	12	–		$I_{TLP} = 16\text{ A}, t_p = 100\text{ ns}$ from Pin 2 to Pin 1
		–	17	–		$I_{TLP} = 30\text{ A}, t_p = 100\text{ ns}$ from Pin 2 to Pin 1
Clamping voltage ²⁾	V_{CL}	–	8	–	V	$I_{PP} = 1\text{ A}, t_p = 8/20\text{ }\mu\text{s}$ from Pin 1 to Pin 2
		–	8.5	–		$I_{PP} = 2.5\text{ A}, t_p = 8/20\text{ }\mu\text{s}$ from Pin 1 to Pin 2
		–	8	–		$I_{PP} = 1\text{ A}, t_p = 8/20\text{ }\mu\text{s}$ from Pin 2 to Pin 1
		–	9	–		$I_{PP} = 2.5\text{ A}, t_p = 8/20\text{ }\mu\text{s}$ from Pin 2 to Pin 1
Dynamic resistance ¹⁾	R_{DYN}	–	0.2	–	Ω	Pin 1 to Pin 2
		–	0.3	–	Ω	Pin 2 to Pin 1

1) Please refer to Application Note AN210[1]. TLP parameter: $Z_0 = 50\text{ }\Omega$, $t_p = 100\text{ ns}$, $t_r = 300\text{ ps}$.

2) Non-repetitive current pulse 8/20 μs exponential decay waveform according to IEC61000-4-5

4 Typical Characteristics Diagrams

Typical characteristics diagrams at $T_A = 25^\circ\text{C}$, unless otherwise specified

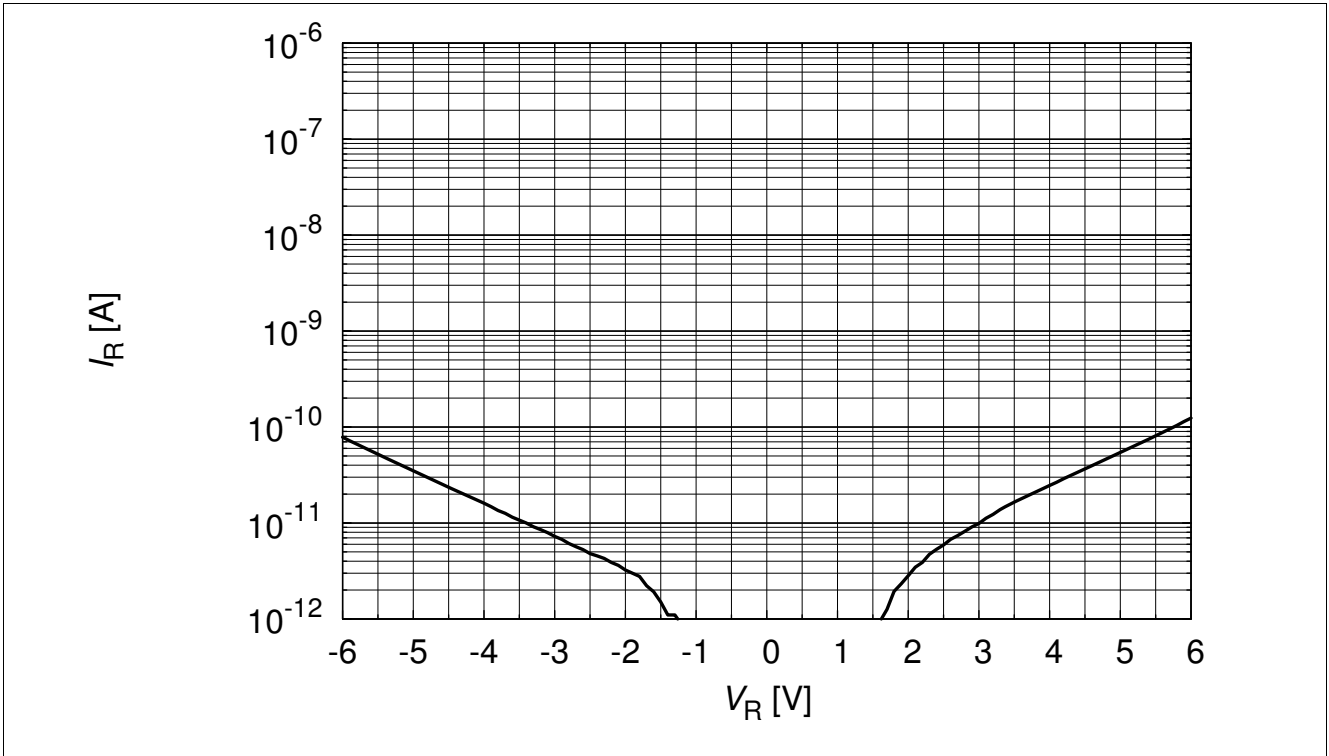

Figure 4-1 Reverse leakage current: $I_R = f(V_R)$

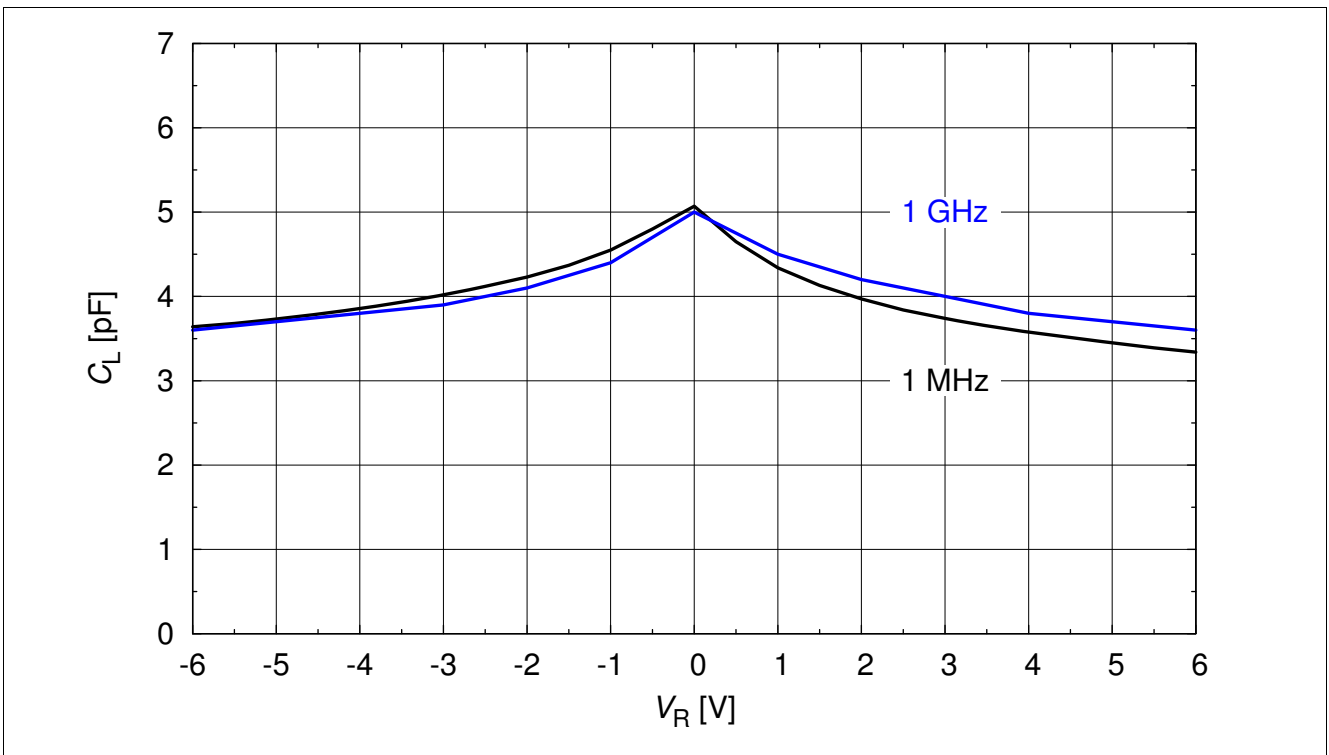

Figure 4-2 Line capacitance: $C_L = f(V_R)$

Typical Characteristics Diagrams

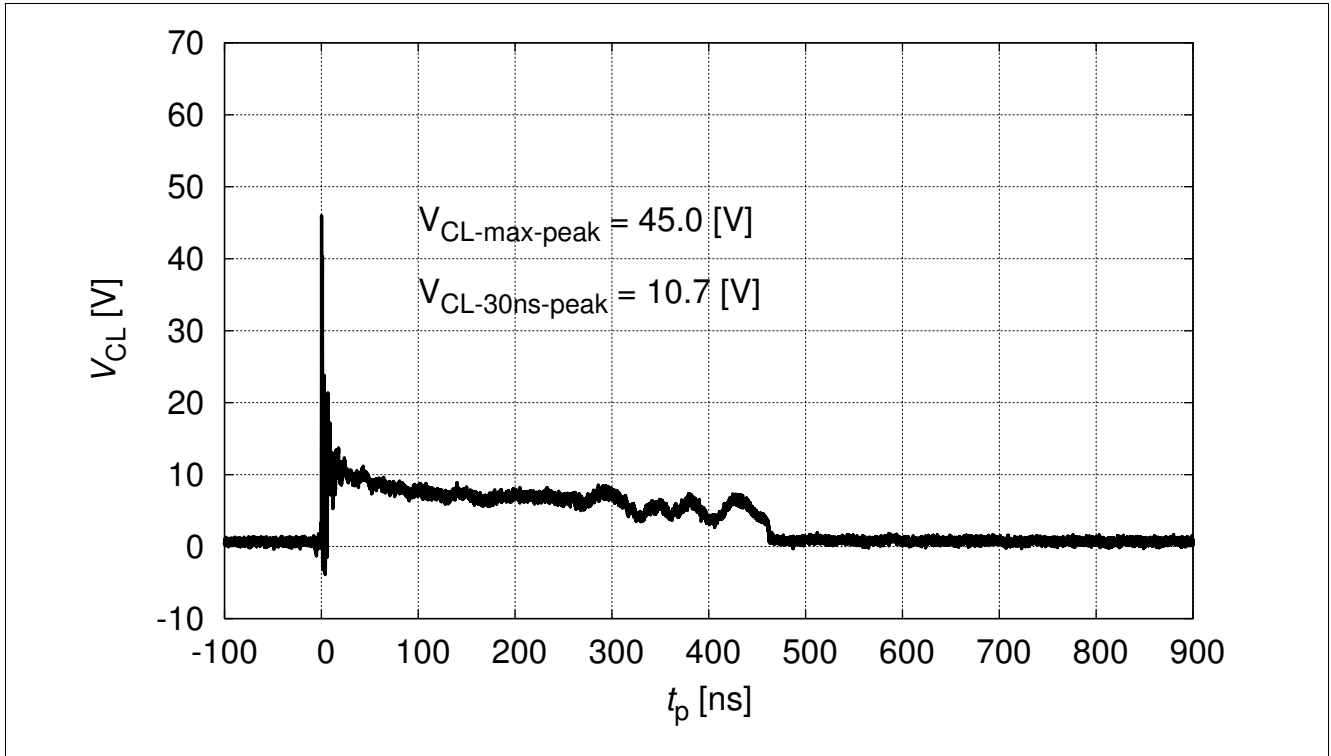

Figure 4-3 Clamping voltage (ESD): $V_{CL} = f(t)$, 8 kV positive pulse from pin 1 to pin 2

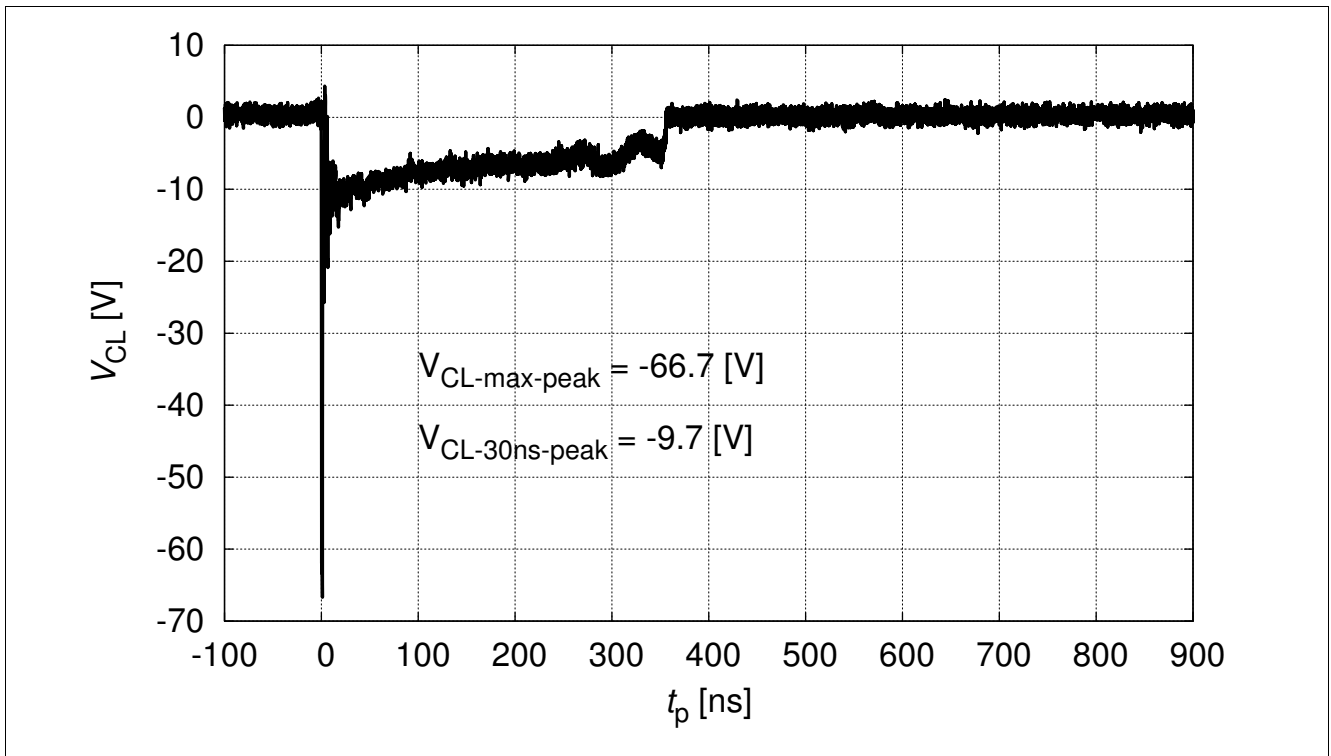

Figure 4-4 Clamping voltage (ESD) $V_{CL} = f(t)$, 8 kV negative pulse from pin 1 to pin 2

Typical Characteristics Diagrams

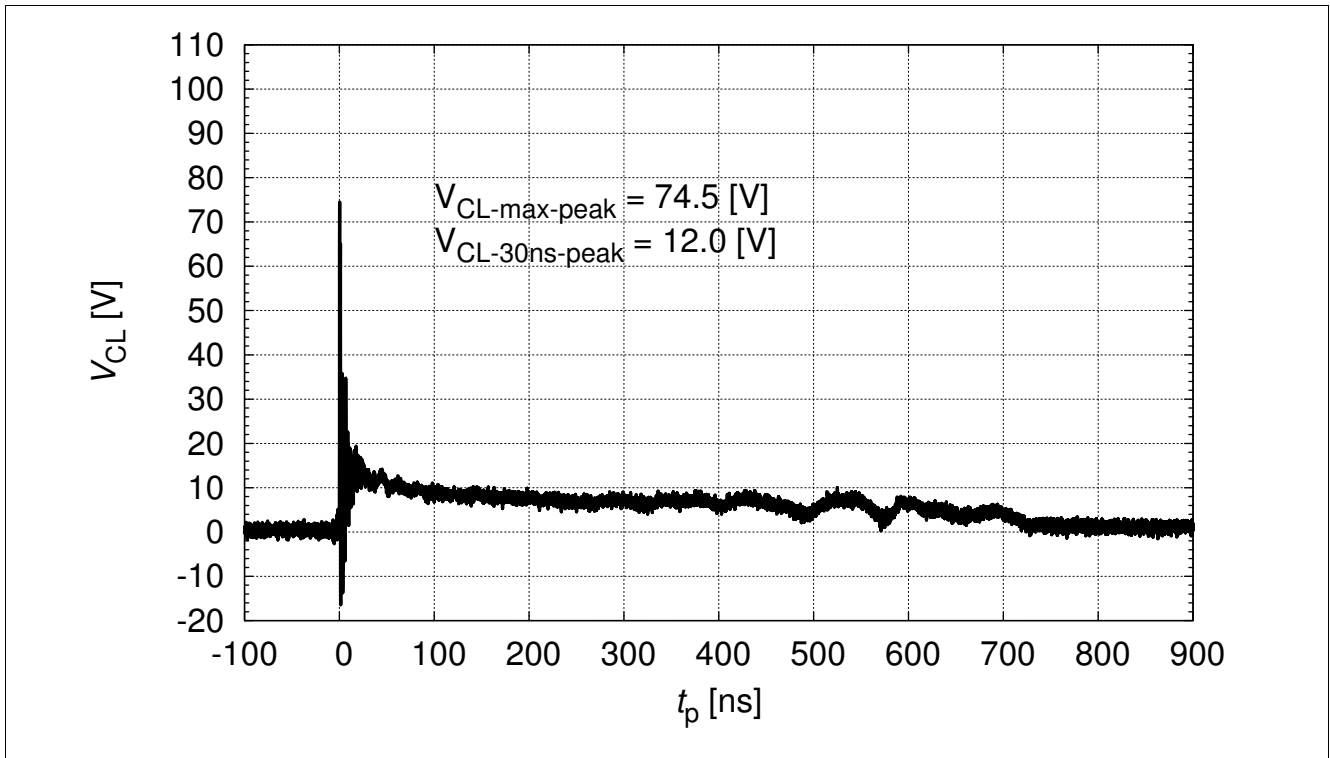

Figure 4-5 Clamping voltage (ESD) $V_{CL} = f(t)$, 15 kV positive pulse from pin 1 to pin 2

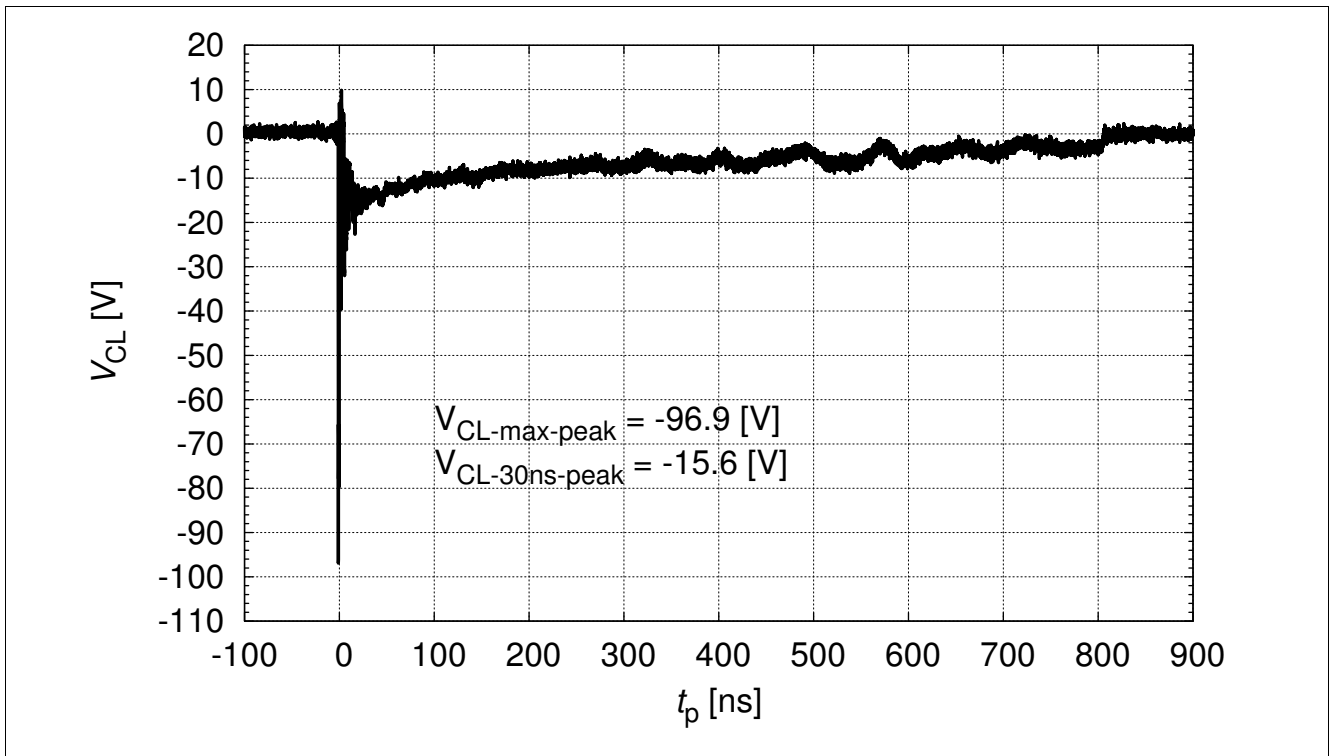

Figure 4-6 Clamping voltage (ESD) $V_{CL} = f(t)$, 15 kV negative pulse from pin 1 to pin 2

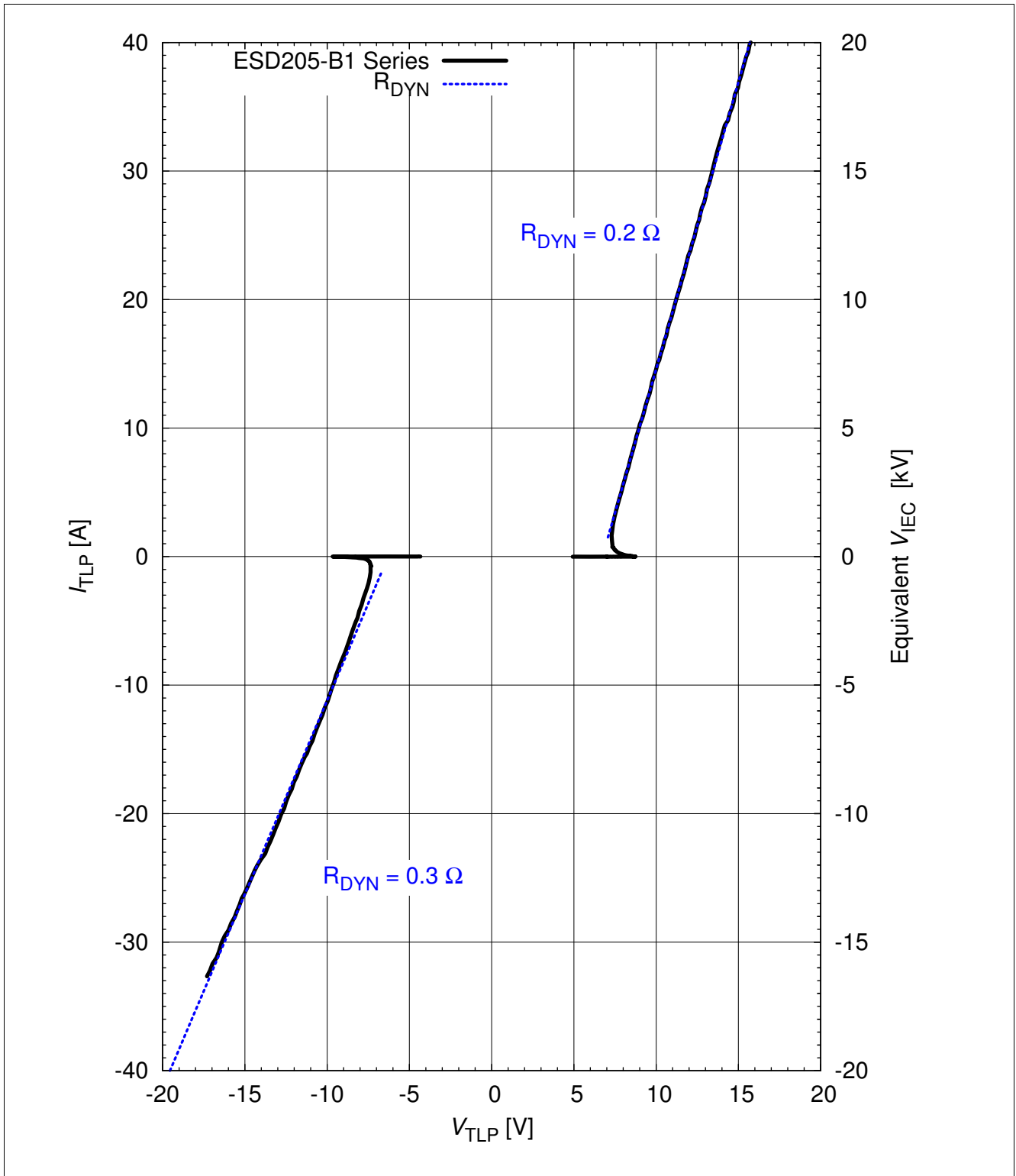

Figure 4-7 Clamping voltage (TLP): $I_{TLP} = f(V_{TLP})$ [1], pin 1 to pin 2

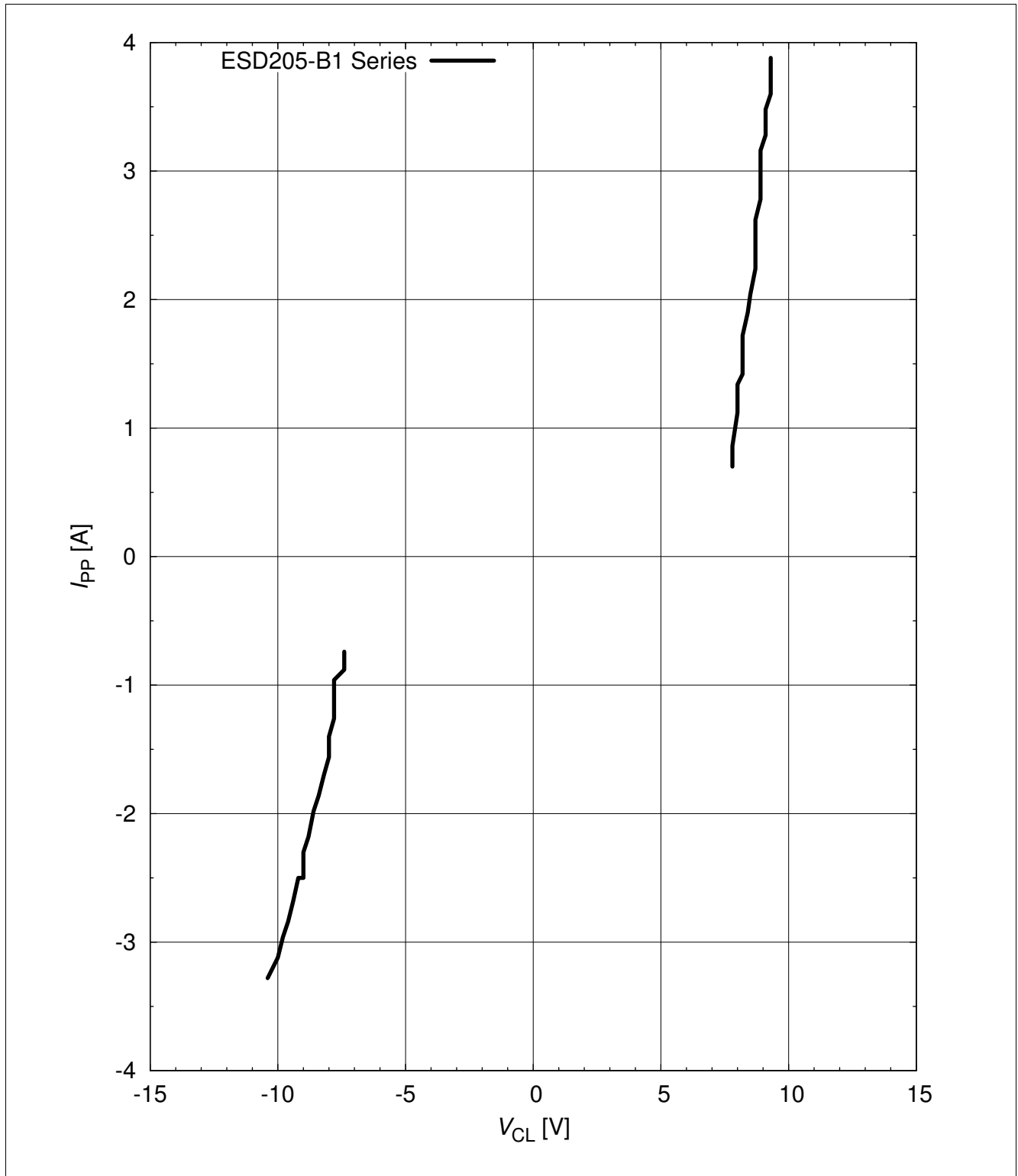

Figure 4-8 Clamping voltage (Surge): $I_{PP} = f(V_{CL})$ [1], pin 1 to pin 2

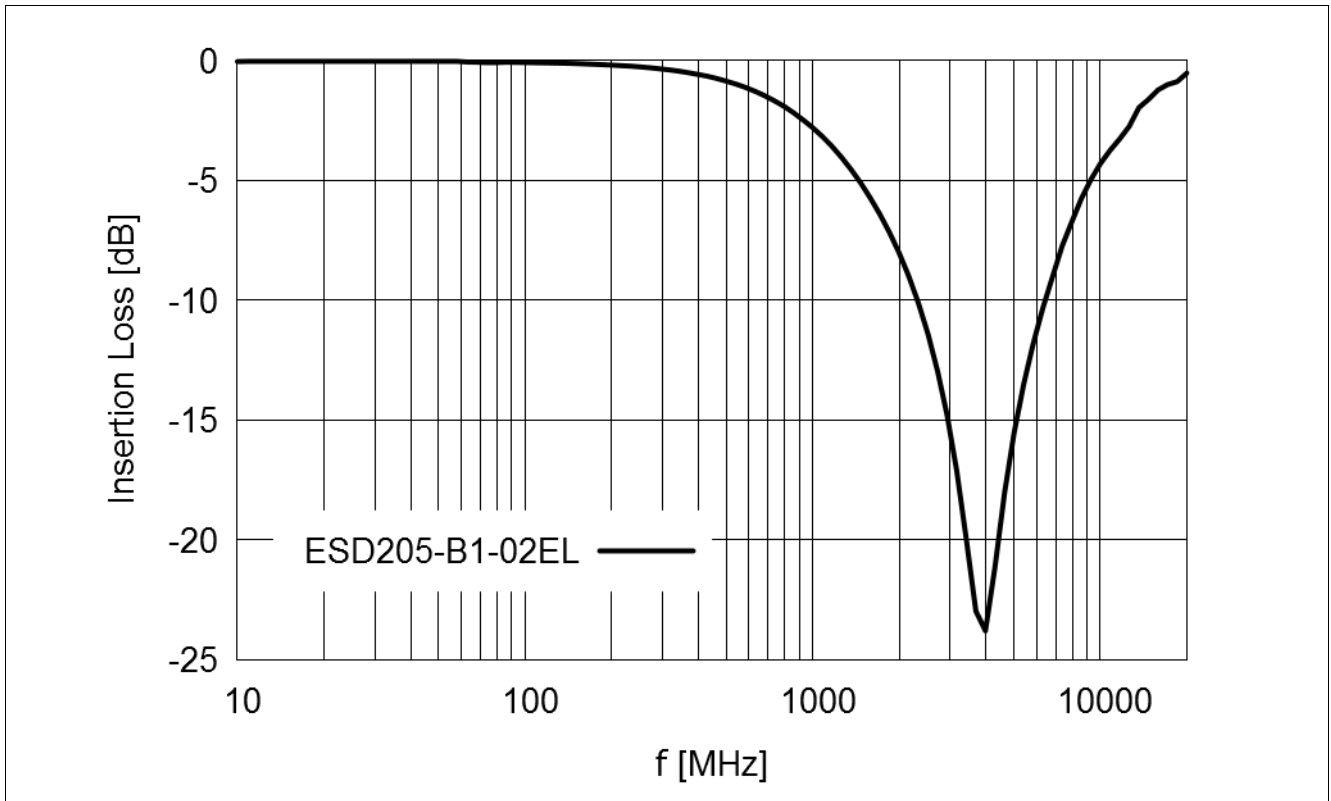

Figure 4-9 Insertion loss vs. frequency in a 50 Ω system

5 Package Information

5.1 TSSLP-2-3

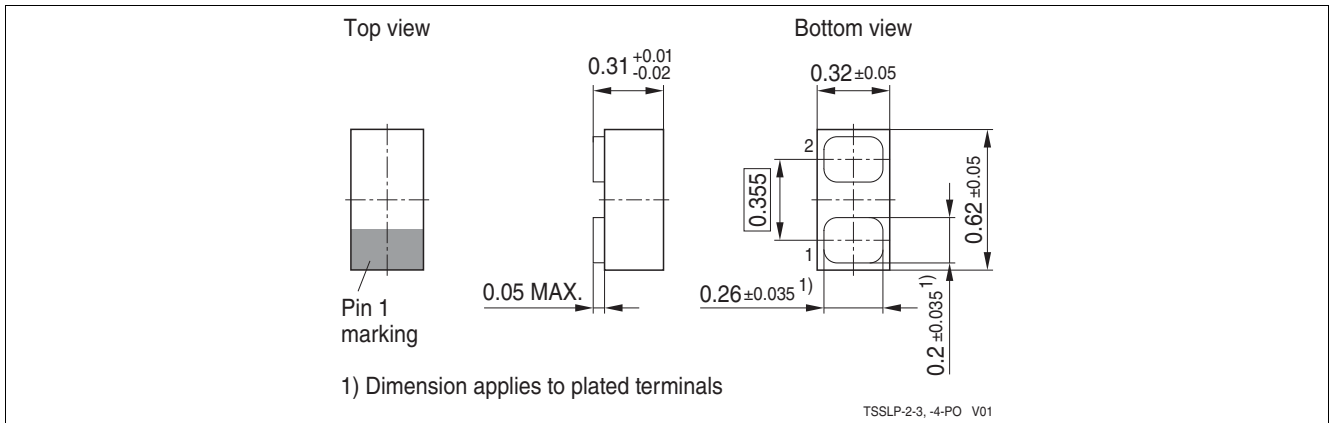

Figure 5-1 TSSLP-2-3 Package outline

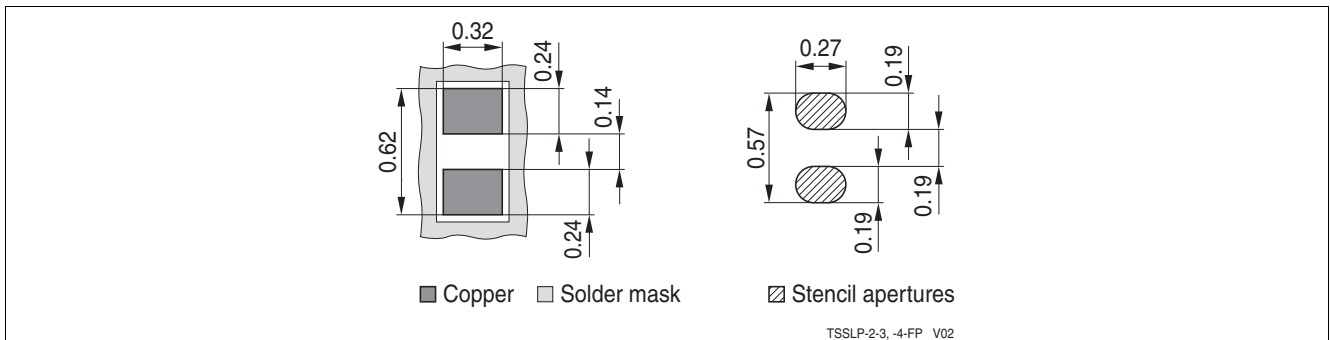

Figure 5-2 TSSLP-2-3 Footprint

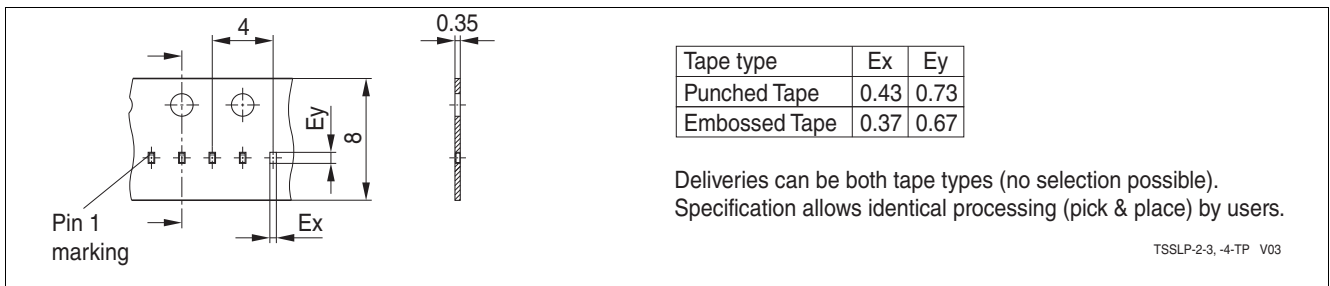

Figure 5-3 TSSLP-2-3 Packing

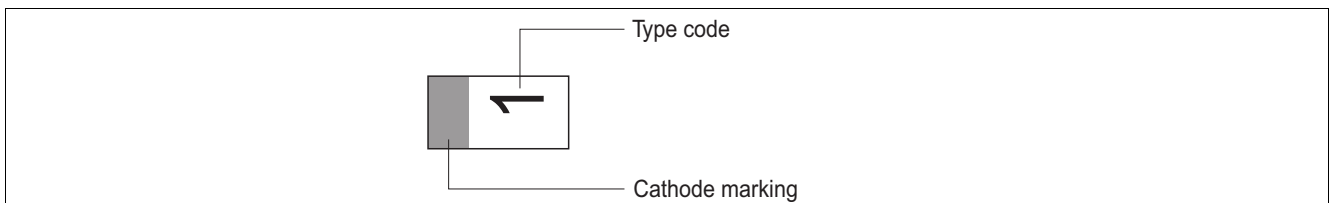

Figure 5-4 TSSLP-2-3 Marking example, Type code see: [Table 1-1 "Ordering Information" on Page 3](#)

5.2 TSLP-2-19

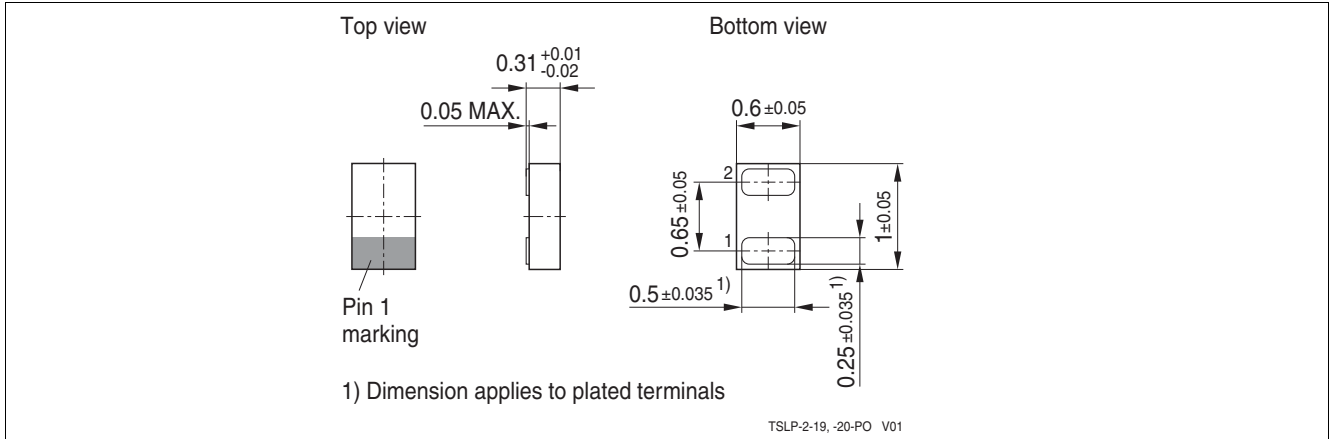

Figure 5-5 TSLP-2-19 Package outline

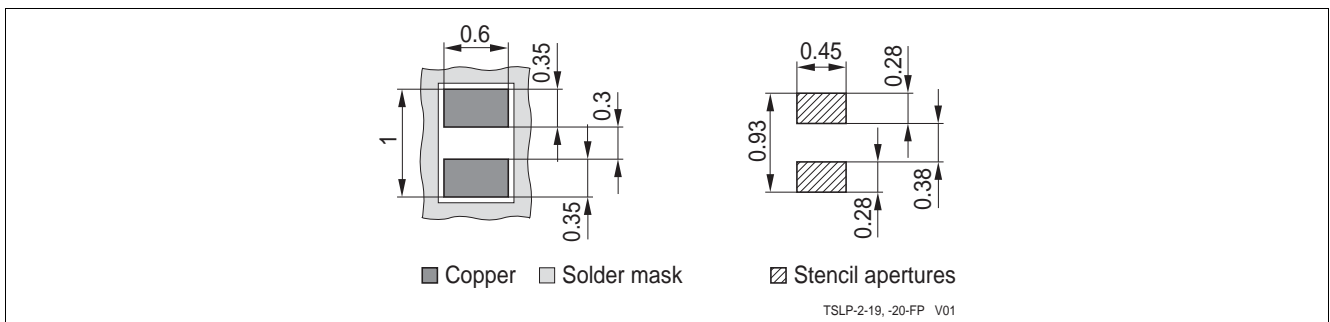

Figure 5-6 TSLP-2-19 Footprint

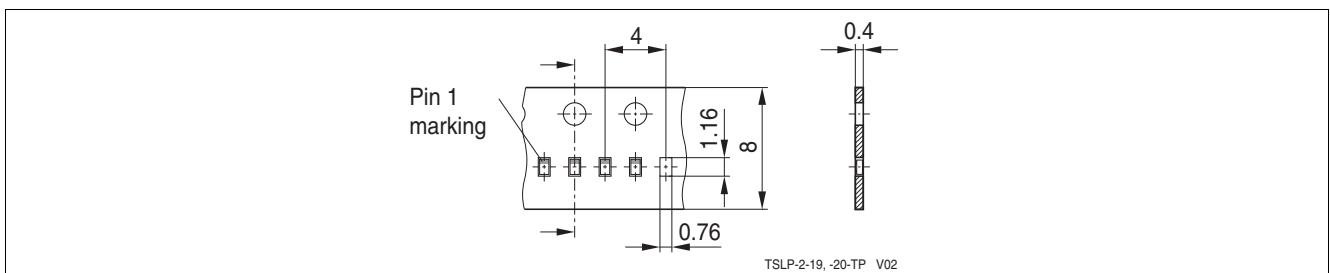

Figure 5-7 TSLP-2-19 Packing

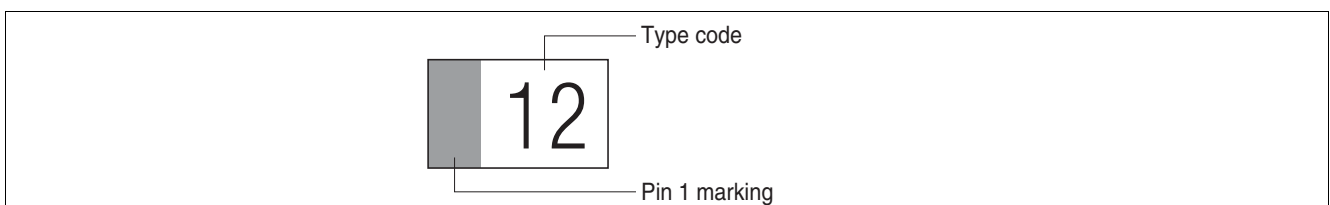

Figure 5-8 TSLP-2-19 Marking example, Type code see: [Table 1-1 “Ordering Information” on Page 3](#)

References

- [1] Infineon AG - **Application Note AN210**: Effective ESD Protection design at System Level Using VF-TLP Characterization Methodology
- [2] Infineon AG - Recommendations for PCB Assembly of Infineon TSLP and TSSLP Packages

Revision History: Revision 1.3, 2013-03-08

Page or Item	Subjects (major changes since previous revision)
Revision 1.4, 2014-05-14	
All	New type ESD205-B1-02EL inserted

Trademarks of Infineon Technologies AG

AURIX™, BlueMoon™, C166™, CanPAK™, CIPOS™, CIPURSE™, COMNEON™, EconoPACK™, CoolMOS™, CoolSET™, CORECONTROL™, CROSSAVE™, DAVE™, EasyPIM™, EconoBRIDGE™, EconoDUAL™, EconoPIM™, EiceDRIVER™, eupec™, FCOS™, HITFET™, HybridPACK™, I²RF™, ISOFACE™, IsoPACK™, MIPAQ™, ModSTACK™, my-d™, NovalithIC™, OmniTune™, OptiMOS™, ORIGA™, PRIMARION™, PrimePACK™, PrimeSTACK™, PRO-SIL™, PROFET™, RASIC™, ReverSave™, SatRIC™, SIEGET™, SINDRION™, SIPMOS™, SMARTi™, SmartLEWIS™, SOLID FLASH™, TEMPFET™, thinQ!™, TRENCHSTOP™, TriCore™, X-GOLD™, X-PMU™, XMM™, XPOSYS™.

Other Trademarks

Advance Design System™ (ADS) of Agilent Technologies, AMBA™, ARM™, MULTI-ICE™, KEIL™, PRIMECELL™, REALVIEW™, THUMB™, μVision™ of ARM Limited, UK. AUTOSAR™ is licensed by AUTOSAR development partnership. Bluetooth™ of Bluetooth SIG Inc. CAT-iq™ of DECT Forum. COLOSSUS™, FirstGPS™ of Trimble Navigation Ltd. EMV™ of EMVCo, LLC (Visa Holdings Inc.). EPCOS™ of Epcos AG. FLEXGO™ of Microsoft Corporation. FlexRay™ is licensed by FlexRay Consortium. HYPERTERMINAL™ of Hilgraeve Incorporated. IEC™ of Commission Electrotechnique Internationale. IrDA™ of Infrared Data Association Corporation. ISO™ of INTERNATIONAL ORGANIZATION FOR STANDARDIZATION. MATLAB™ of MathWorks, Inc. MAXIM™ of Maxim Integrated Products, Inc. MICROTEC™, NUCLEUS™ of Mentor Graphics Corporation. Mifare™ of NXP. MIPI™ of MIPI Alliance, Inc. MIPS™ of MIPS Technologies, Inc., USA. muRata™ of MURATA MANUFACTURING CO., MICROWAVE OFFICE™ (MWO) of Applied Wave Research Inc., OmniVision™ of OmniVision Technologies, Inc. Openwave™ Openwave Systems Inc. RED HAT™ Red Hat, Inc. RFMD™ RF Micro Devices, Inc. SIRIUS™ of Sirius Satellite Radio Inc. SOLARIS™ of Sun Microsystems, Inc. SPANSION™ of Spansion LLC Ltd. Symbian™ of Symbian Software Limited. TAIYO YUDEN™ of Taiyo Yuden Co. TEAKLITE™ of CEVA, Inc. TEKTRONIX™ of Tektronix Inc. TOKO™ of TOKO KABUSHIKI KAISHA TA. UNIX™ of X/Open Company Limited. VERILOG™, PALLADIUM™ of Cadence Design Systems, Inc. VLYNQ™ of Texas Instruments Incorporated. VXWORKS™, WIND RIVER™ of WIND RIVER SYSTEMS, INC. ZETEX™ of Diodes Zetex Limited.



Last Trademarks Update 2010-10-26

www.infineon.com

Published by Infineon Technologies AG

Looking for pricing, stock, or lifecycle information?

Click below to explore more details on WIN SOURCE:

-  [View ESD205B102ELE6327XTMA1 on WIN SOURCE](#)
-  [Infineon Technologies Information](#)

Optimize Your Supply Chain with WIN SOURCE Solutions

-  Global Sourcing Solution
-  Obsolete Management
-  Cost Control Management
-  Shortage Management
-  Alternative Solution
-  Excess Inventory Management