



# THE DATASHEET OF BAV756S,115



# BAV756S; BAW56 series

High-speed switching diodes

Rev. 6 — 18 March 2015

Product data sheet

## 1. Product profile

### 1.1 General description

High-speed switching diodes, encapsulated in small Surface-Mounted Device (SMD) plastic packages.

Table 1. Product overview

Type number	Package			Package configuration	Configuration
	Nexperia	JEITA	JEDEC		
BAV756S	SOT363	SC-88	-	very small	quadruple common anode/common cathode
BAW56	SOT23	-	TO-236AB	small	dual common anode
BAW56M	SOT883	SC-101	-	leadless ultra small	dual common anode
BAW56S	SOT363	SC-88	-	very small	quadruple common anode/common anode
BAW56T	SOT416	SC-75	-	ultra small	dual common anode
BAW56W	SOT323	SC-70	-	very small	dual common anode

### 1.2 Features and benefits

- High switching speed:  $t_{rr} \leq 4$  ns
- Low leakage current
- Small SMD plastic packages
- Low capacitance:  $C_d \leq 2$  pF
- Reverse voltage:  $V_R \leq 90$  V
- AEC-Q101 qualified

### 1.3 Applications

- High-speed switching
- General-purpose switching

### 1.4 Quick reference data

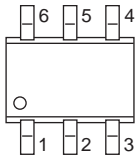
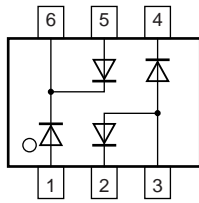
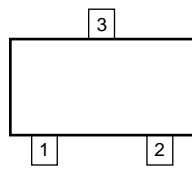
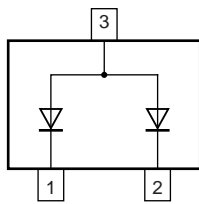
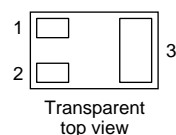
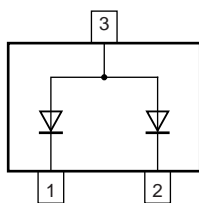
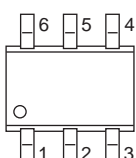
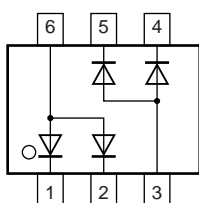
Table 2. Quick reference data

Symbol	Parameter	Conditions	Min	Typ	Max	Unit
Per diode						
$I_R$	reverse current	$V_R = 80$ V	-	-	0.5	$\mu$ A
$V_R$	reverse voltage		-	-	90	V
$t_{rr}$	reverse recovery time		[1]	-	4	ns

[1] When switched from  $I_F = 10$  mA to  $I_R = 10$  mA;  $R_L = 100$   $\Omega$ ; measured at  $I_R = 1$  mA.

## 2. Pinning information

Table 3. Pinning

Pin	Description	Simplified outline	Symbol
<b>BAV756S</b>			
1	anode (diode 1)		 <p>006aab103</p>
2	cathode (diode 2)		
3	common anode (diode 2 and diode 3)		
4	cathode (diode 3)		
5	anode (diode 4)		
6	common cathode (diode 1 and diode 4)		
<b>BAW56; BAW56T; BAW56W</b>			
1	cathode (diode 1)	 <p>006aaa144</p>	 <p>006aab099</p>
2	cathode (diode 2)		
3	common anode		
<b>BAW56M</b>			
1	cathode (diode 1)	 <p>Transparent top view</p>	 <p>006aab099</p>
2	cathode (diode 2)		
3	common anode		
<b>BAW56S</b>			
1	cathode (diode 1)		 <p>006aab102</p>
2	cathode (diode 2)		
3	common anode (diode 3 and diode 4)		
4	cathode (diode 3)		
5	cathode (diode 4)		
6	common anode (diode 1 and diode 2)		

### 3. Ordering information

Table 4. Ordering information

Type number	Package		Version
	Name	Description	
BAV756S	SC-88	plastic surface-mounted package; 6 leads	SOT363
BAW56	-	plastic surface-mounted package; 3 leads	SOT23
BAW56M	SC-101	leadless ultra small plastic package; 3 solder lands; body 1.0 × 0.6 × 0.5 mm	SOT883
BAW56S	SC-88	plastic surface-mounted package; 6 leads	SOT363
BAW56T	SC-75	plastic surface-mounted package; 3 leads	SOT416
BAW56W	SC-70	plastic surface-mounted package; 3 leads	SOT323

### 4. Marking

Table 5. Marking codes

Type number	Marking code <sup>[1]</sup>
BAV756S	A7*
BAW56	A1*
BAW56M	S5
BAW56S	A1*
BAW56T	A1
BAW56W	A1*

- [1] \* = -: made in Hong Kong  
 \* = p: made in Hong Kong  
 \* = t: made in Malaysia  
 \* = W: made in China

### 5. Limiting values

Table 6. Limiting values

In accordance with the Absolute Maximum Rating System (IEC 60134).

Symbol	Parameter	Conditions	Min	Max	Unit
<b>Per diode</b>					
$V_{RRM}$	repetitive peak reverse voltage		-	90	V
$V_R$	reverse voltage		-	90	V
$I_F$	forward current				
	BAV756S	$T_s = 60\text{ °C}$	-	250	mA
	BAW56	$T_{amb} \leq 25\text{ °C}$	-	215	mA
	BAW56M	$T_{amb} \leq 25\text{ °C}$	-	150	mA
	BAW56S	$T_s = 60\text{ °C}$	-	250	mA
	BAW56T	$T_s = 90\text{ °C}$	-	150	mA
	BAW56W	$T_{amb} \leq 25\text{ °C}$	-	150	mA

**Table 6. Limiting values ...continued**

In accordance with the Absolute Maximum Rating System (IEC 60134).

Symbol	Parameter	Conditions	Min	Max	Unit
$I_{FRM}$	repetitive peak forward current		-	500	mA
$I_{FSM}$	non-repetitive peak forward current	square wave [1]			
		$t_p = 1 \mu\text{s}$	-	4	A
		$t_p = 1 \text{ms}$	-	1	A
		$t_p = 1 \text{s}$	-	0.5	A
$P_{tot}$	total power dissipation	[2]			
	BAV756S	$T_s = 60 \text{ }^\circ\text{C}$	-	350	mW
	BAW56	$T_{amb} \leq 25 \text{ }^\circ\text{C}$	-	250	mW
	BAW56M	$T_{amb} \leq 25 \text{ }^\circ\text{C}$ [3]	-	250	mW
	BAW56S	$T_s = 60 \text{ }^\circ\text{C}$	-	350	mW
	BAW56T	$T_s = 90 \text{ }^\circ\text{C}$ [4]	-	170	mW
	BAW56W	$T_{amb} \leq 25 \text{ }^\circ\text{C}$	-	200	mW
<b>Per device</b>					
$I_F$	forward current				
	BAV756S	$T_s = 60 \text{ }^\circ\text{C}$	-	100	mA
	BAW56	$T_{amb} \leq 25 \text{ }^\circ\text{C}$	-	125	mA
	BAW56M	$T_{amb} \leq 25 \text{ }^\circ\text{C}$	-	75	mA
	BAW56S	$T_s = 60 \text{ }^\circ\text{C}$	-	100	mA
	BAW56T	$T_s = 90 \text{ }^\circ\text{C}$	-	75	mA
	BAW56W	$T_{amb} \leq 25 \text{ }^\circ\text{C}$	-	130	mA
$T_j$	junction temperature		-	150	$^\circ\text{C}$
$T_{amb}$	ambient temperature		-65	+150	$^\circ\text{C}$
$T_{stg}$	storage temperature		-65	+150	$^\circ\text{C}$

[1]  $T_j = 25 \text{ }^\circ\text{C}$  prior to surge.

[2] Device mounted on an FR4 Printed-Circuit Board (PCB), single-sided copper, tin-plated and standard footprint.

[3] Reflow soldering is the only recommended soldering method.

[4] Single diode loaded.

## 6. Thermal characteristics

**Table 7. Thermal characteristics**

Symbol	Parameter	Conditions	Min	Typ	Max	Unit
<b>Per diode</b>						
$R_{th(j-a)}$	thermal resistance from junction to ambient	in free air [1]				
	BAW56		-	-	500	K/W
	BAW56M	[2]	-	-	500	K/W
	BAW56W		-	-	625	K/W

Table 7. Thermal characteristics ...continued

Symbol	Parameter	Conditions	Min	Typ	Max	Unit
$R_{th(j-sp)}$	thermal resistance from junction to solder point					
	BAV756S		-	-	255	K/W
	BAW56		-	-	360	K/W
	BAW56S		-	-	255	K/W
	BAW56T		-	-	350	K/W
	BAW56W		-	-	300	K/W

[1] Device mounted on an FR4 PCB, single-sided copper, tin-plated and standard footprint.

[2] Reflow soldering is the only recommended soldering method.

## 7. Characteristics

Table 8. Characteristics

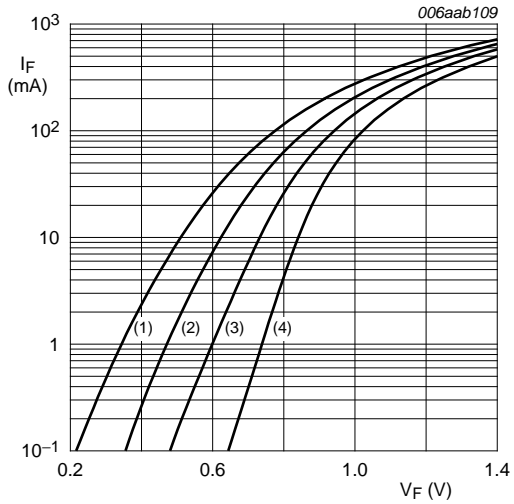
$T_{amb} = 25\text{ °C}$  unless otherwise specified.

Symbol	Parameter	Conditions	Min	Typ	Max	Unit
<b>Per diode</b>						
$V_F$	forward voltage	[1]				
		$I_F = 1\text{ mA}$	-	-	715	mV
		$I_F = 10\text{ mA}$	-	-	855	mV
		$I_F = 50\text{ mA}$	-	-	1	V
		$I_F = 150\text{ mA}$	-	-	1.25	V
$I_R$	reverse current	$V_R = 25\text{ V}$	-	-	30	nA
		$V_R = 80\text{ V}$	-	-	0.5	$\mu\text{A}$
		$V_R = 25\text{ V}; T_j = 150\text{ °C}$	-	-	30	$\mu\text{A}$
		$V_R = 80\text{ V}; T_j = 150\text{ °C}$	-	-	150	$\mu\text{A}$
$C_d$	diode capacitance	$V_R = 0\text{ V}; f = 1\text{ MHz}$	-	-	2	pF
$t_{rr}$	reverse recovery time	[2]	-	-	4	ns
$V_{FR}$	forward recovery voltage	[3]	-	-	1.75	V

[1] Pulse test:  $t_p \leq 300\text{ }\mu\text{s}$ ;  $\delta \leq 0.02$ .

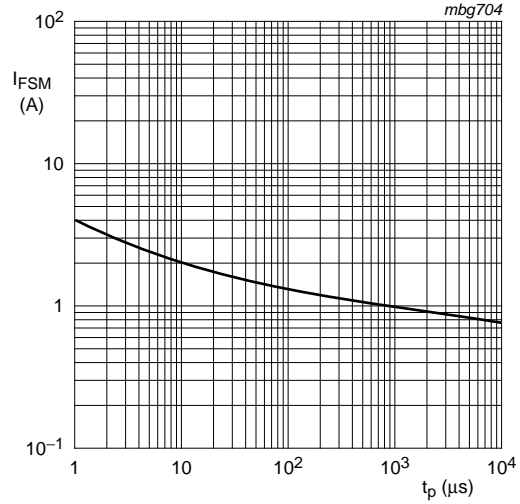
[2] When switched from  $I_F = 10\text{ mA}$  to  $I_R = 10\text{ mA}$ ;  $R_L = 100\text{ }\Omega$ ; measured at  $I_R = 1\text{ mA}$ .

[3] When switched from  $I_F = 10\text{ mA}$ ;  $t_r = 20\text{ ns}$ .



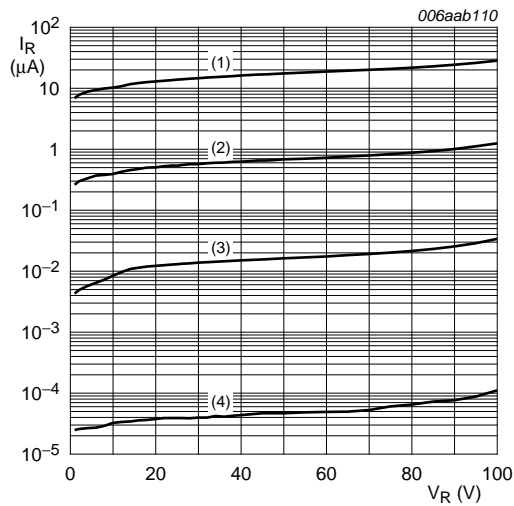
- (1)  $T_{amb} = 150^\circ\text{C}$
- (2)  $T_{amb} = 85^\circ\text{C}$
- (3)  $T_{amb} = 25^\circ\text{C}$
- (4)  $T_{amb} = -40^\circ\text{C}$

Fig 1. Forward current as a function of forward voltage; typical values



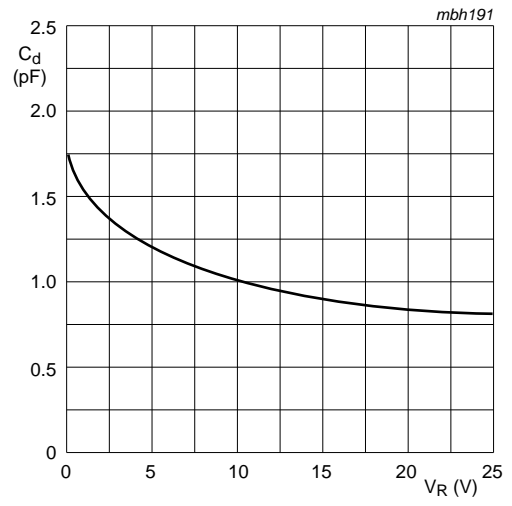
Based on square wave currents.  
 $T_j = 25^\circ\text{C}$ ; prior to surge

Fig 2. Non-repetitive peak forward current as a function of pulse duration; maximum values



- (1)  $T_{amb} = 150^\circ\text{C}$
- (2)  $T_{amb} = 85^\circ\text{C}$
- (3)  $T_{amb} = 25^\circ\text{C}$
- (4)  $T_{amb} = -40^\circ\text{C}$

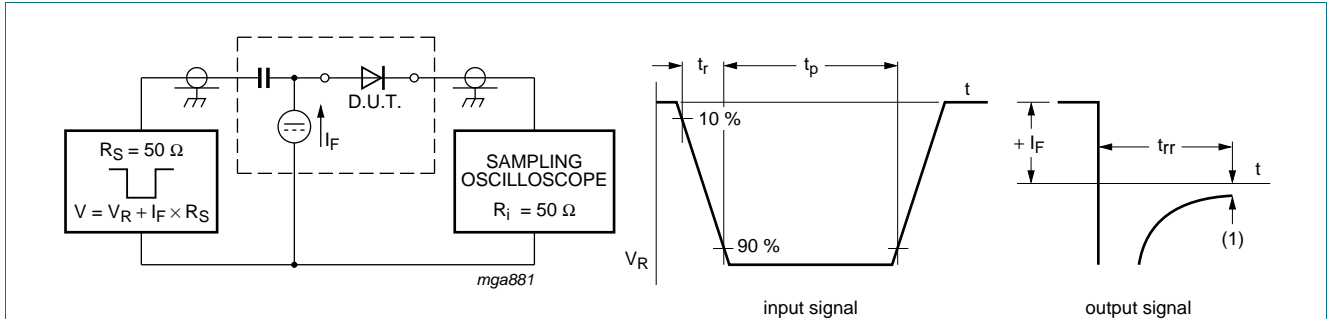
Fig 3. Reverse current as a function of reverse voltage; typical values



$f = 1\text{ MHz}$ ;  $T_{amb} = 25^\circ\text{C}$

Fig 4. Diode capacitance as a function of reverse voltage; typical values

**8. Test information**

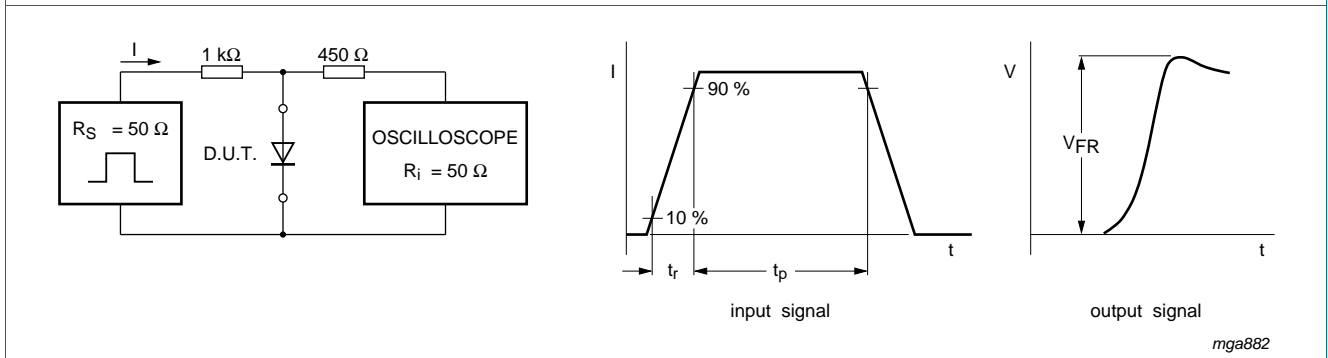


(1)  $I_R = 1 \text{ mA}$

Input signal: reverse pulse rise time  $t_r = 0.6 \text{ ns}$ ; reverse voltage pulse duration  $t_p = 100 \text{ ns}$ ; duty cycle  $\delta = 0.05$

Oscilloscope: rise time  $t_r = 0.35 \text{ ns}$

**Fig 5. Reverse recovery time test circuit and waveforms**



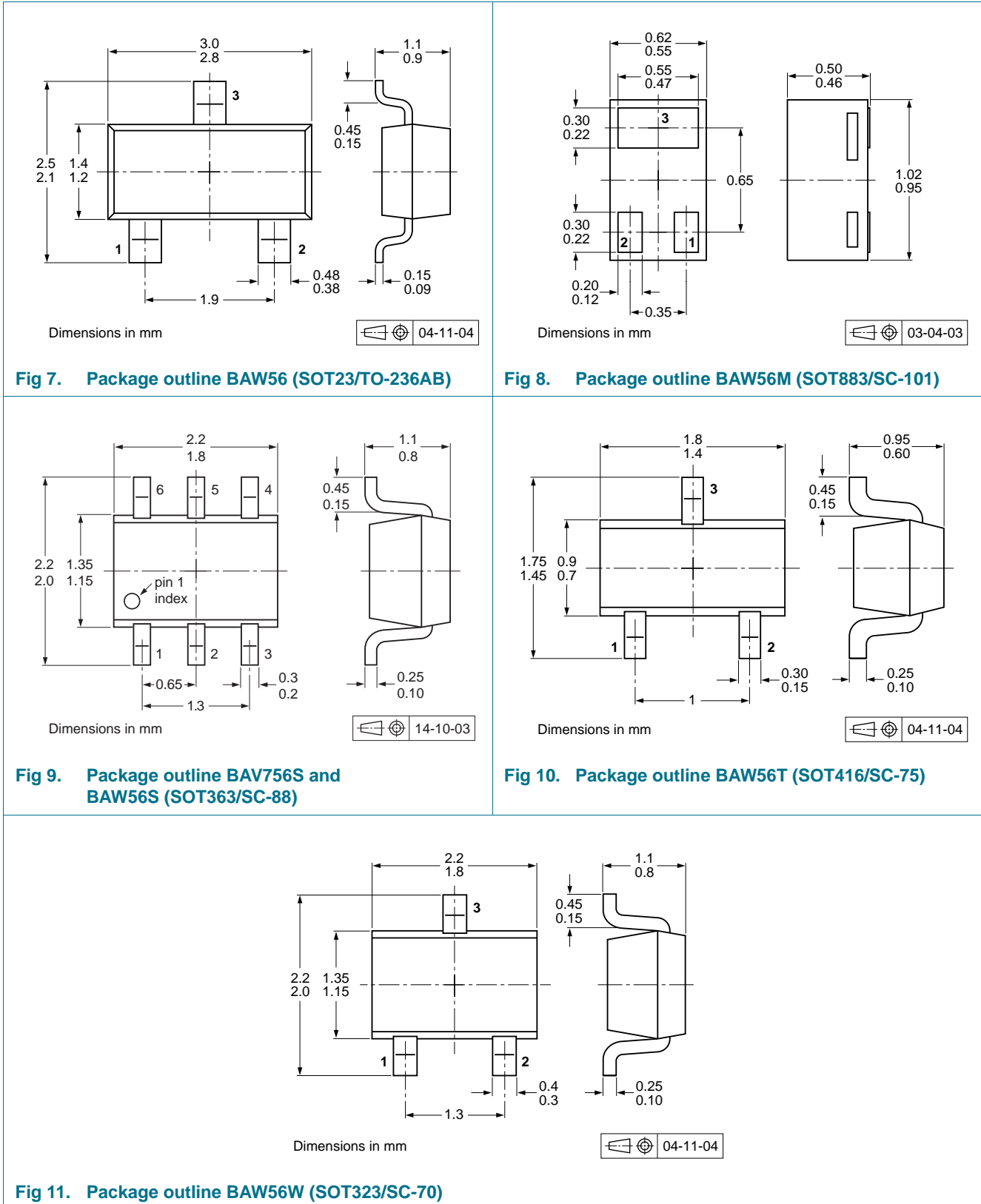
Input signal: forward pulse rise time  $t_r = 20 \text{ ns}$ ; forward current pulse duration  $t_p \geq 100 \text{ ns}$ ; duty cycle  $\delta \leq 0.005$

**Fig 6. Forward recovery voltage test circuit and waveforms**

**8.1 Quality information**

This product has been qualified in accordance with the Automotive Electronics Council (AEC) standard Q101 - *Stress test qualification for discrete semiconductors*, and is suitable for use in automotive applications.

**9. Package outline**



## 10. Packing information

**Table 9. Packing methods**

The indicated -xxx are the last three digits of the 12NC ordering code.<sup>[1]</sup>

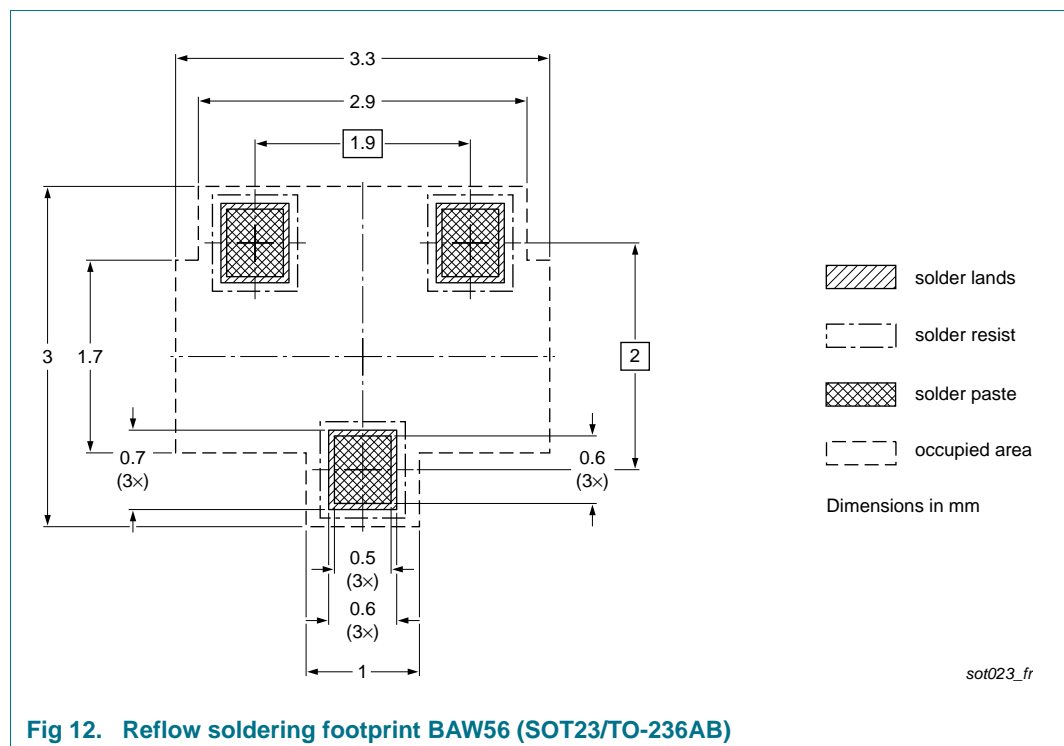
Type number	Package	Description	Packing quantity	
			3000	10000
BAV756S	SOT363	4 mm pitch, 8 mm tape and reel; T1 <sup>[2]</sup>	-115	-135
		4 mm pitch, 8 mm tape and reel; T2 <sup>[3]</sup>	-125	-165
BAW56	SOT23	4 mm pitch, 8 mm tape and reel	-215	-235
BAW56M	SOT883	2 mm pitch, 8 mm tape and reel	-	-315
BAW56S	SOT363	4 mm pitch, 8 mm tape and reel; T1 <sup>[2]</sup>	-115	-135
		4 mm pitch, 8 mm tape and reel; T2 <sup>[3]</sup>	-125	-165
BAW56T	SOT416	4 mm pitch, 8 mm tape and reel	-115	-135
BAW56W	SOT323	4 mm pitch, 8 mm tape and reel	-115	-135

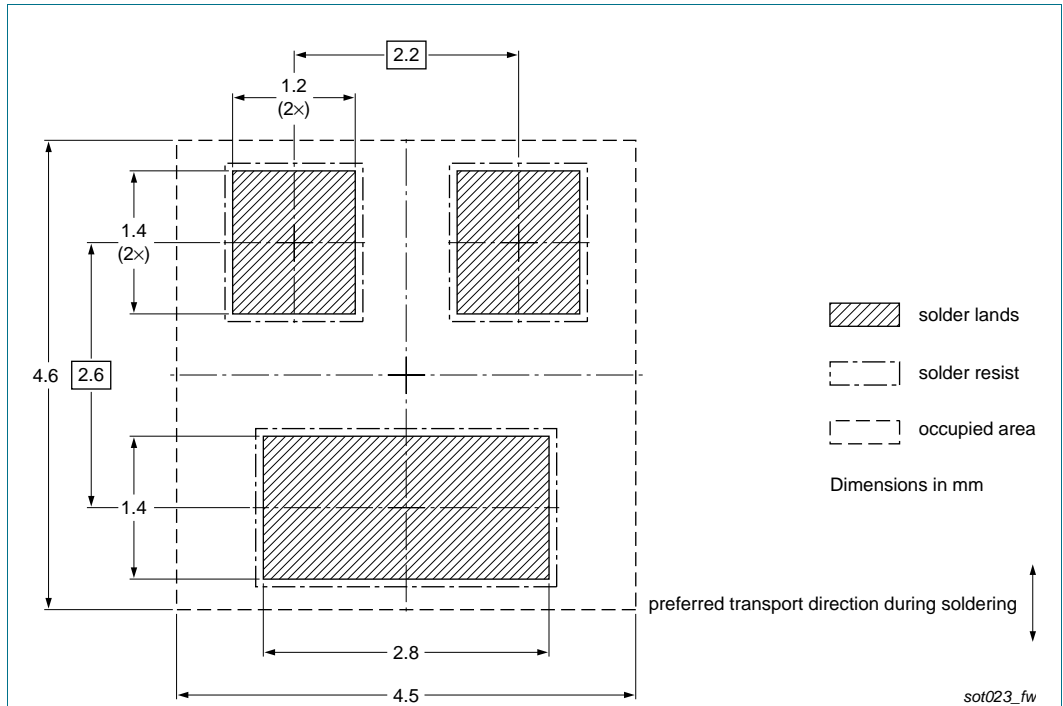
[1] For further information and the availability of packing methods, see [Section 14](#).

[2] T1: normal taping

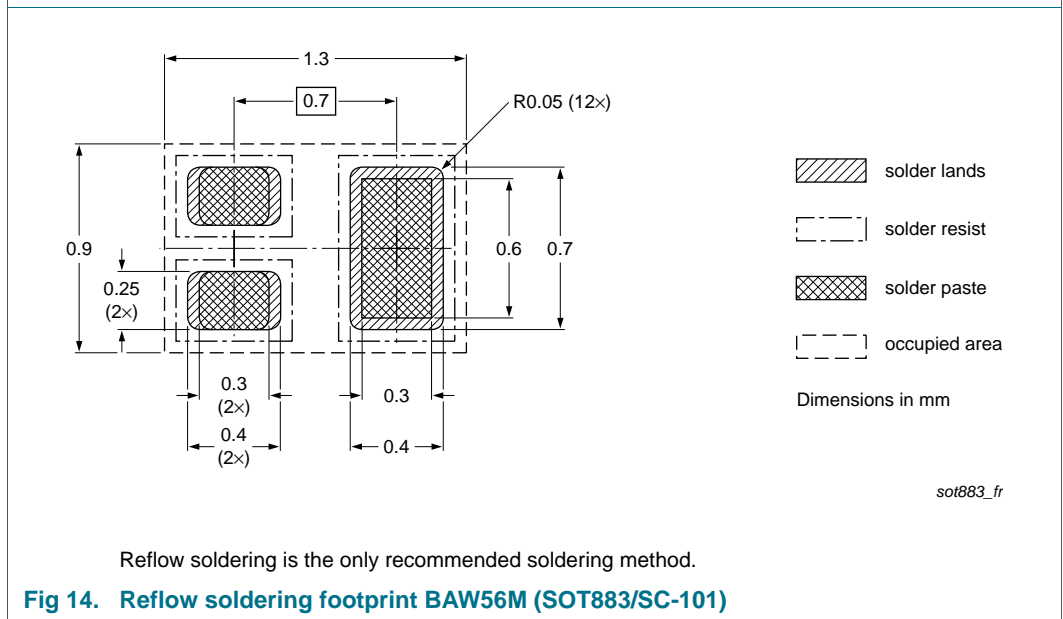
[3] T2: reverse taping

## 11. Soldering

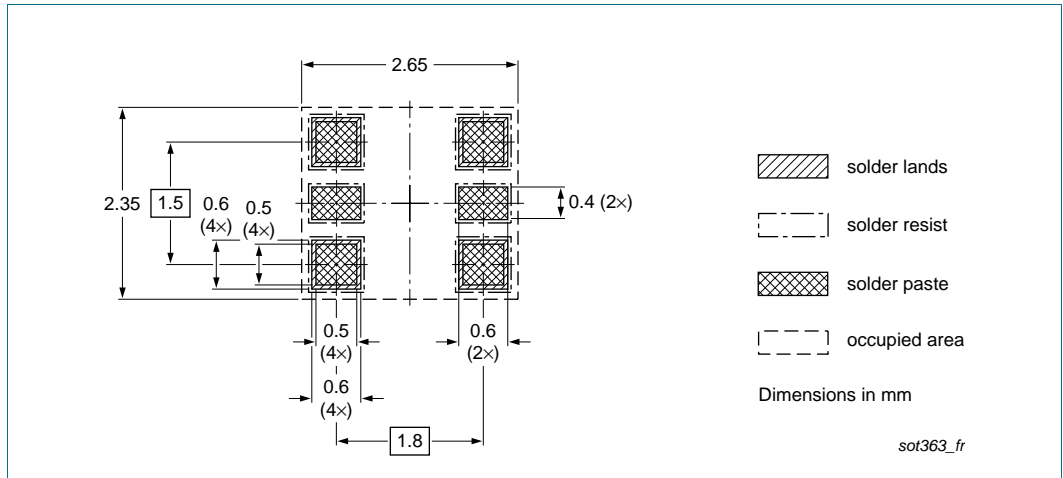




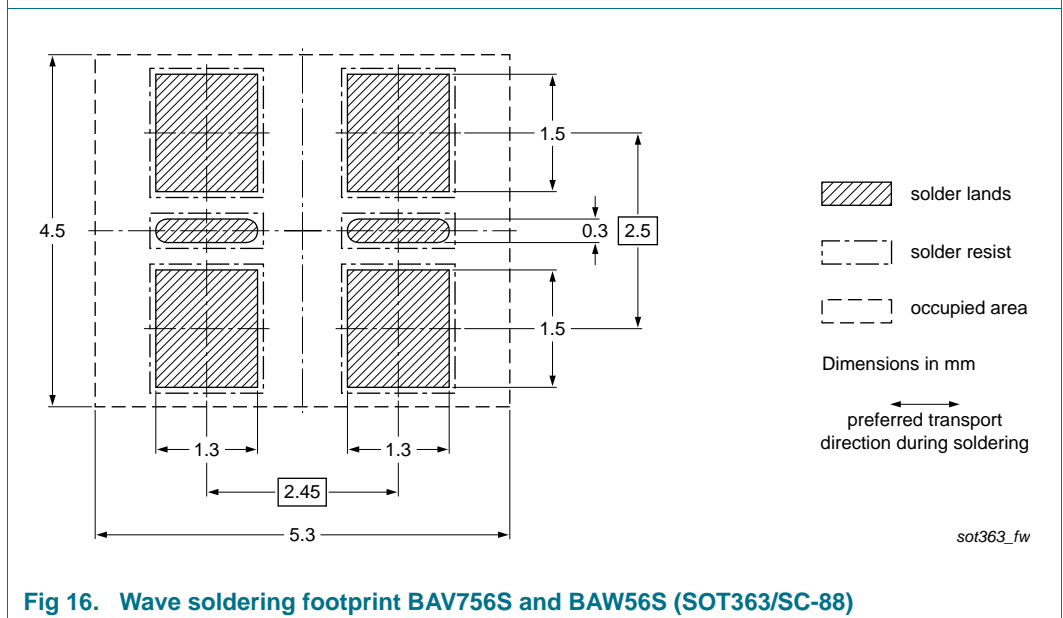
**Fig 13. Wave soldering footprint BAW56 (SOT23/TO-236AB)**



**Fig 14. Reflow soldering footprint BAW56M (SOT883/SC-101)**



**Fig 15. Reflow soldering footprint BAV756S and BAW56S (SOT363/SC-88)**



**Fig 16. Wave soldering footprint BAV756S and BAW56S (SOT363/SC-88)**

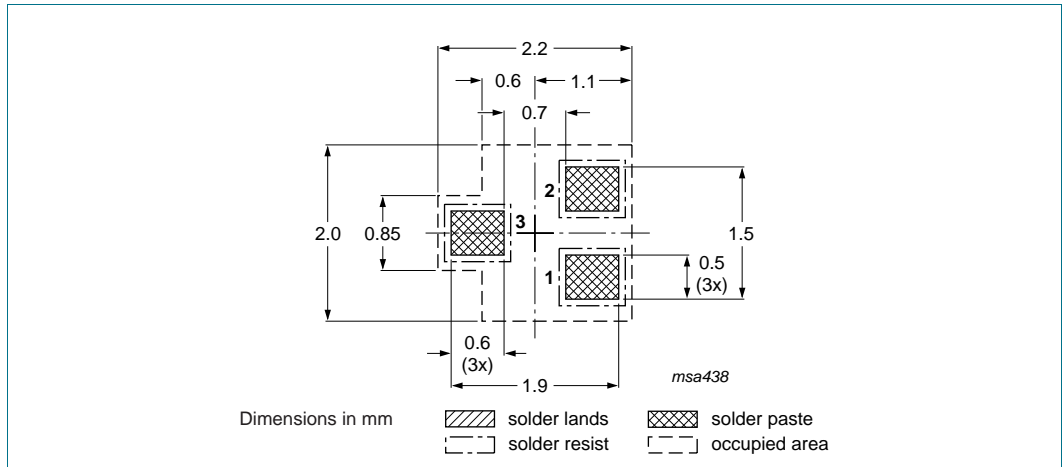


Fig 17. Reflow soldering footprint BAW56T (SOT416/SC-75)

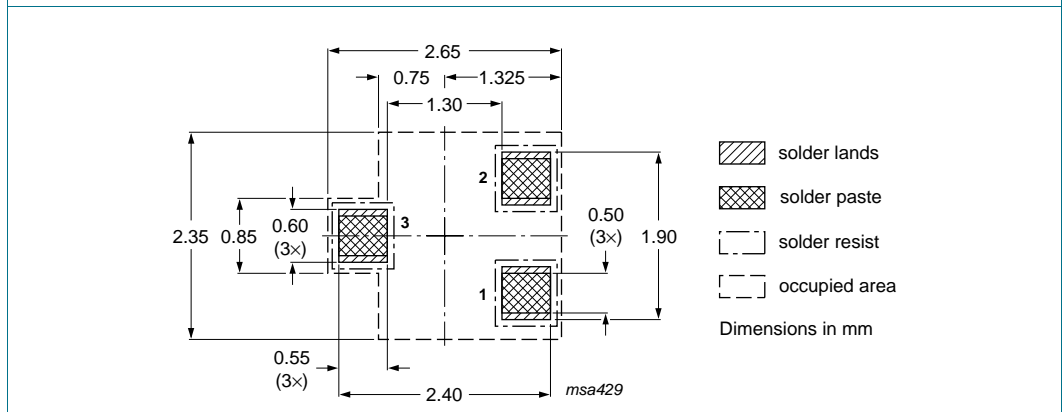


Fig 18. Reflow soldering footprint BAW56W (SOT323/SC-70)

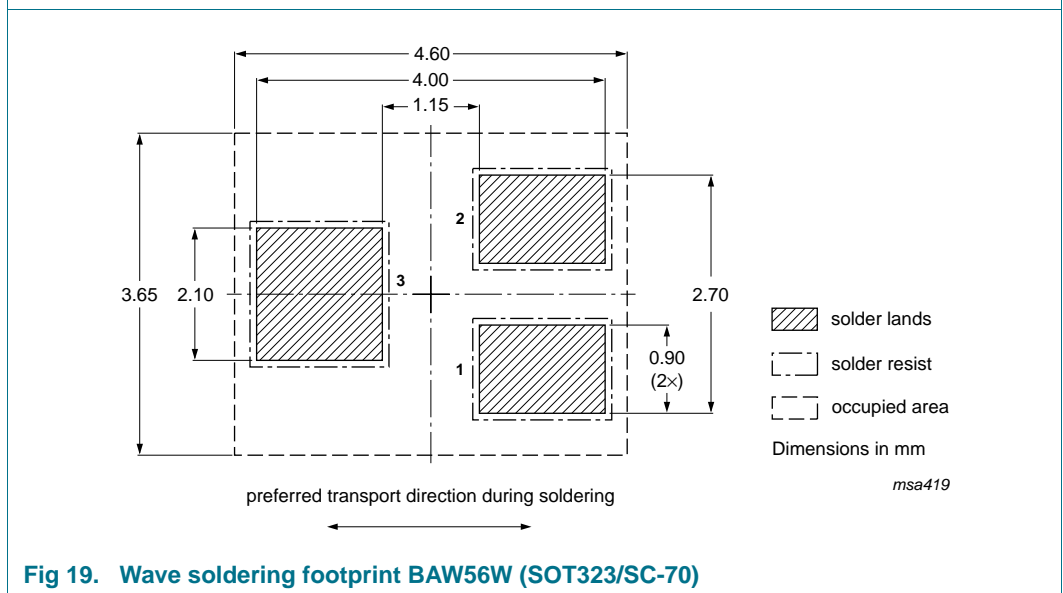


Fig 19. Wave soldering footprint BAW56W (SOT323/SC-70)

## 12. Revision history

Table 10. Revision history

Document ID	Release date	Data sheet status	Change notice	Supersedes
BAV756S_BAW56_SER v.6	20150318	Product data sheet	-	BAV756S_BAW56_SER_5
Modifications:	<ul style="list-style-type: none"> <li>The format of this data sheet has been redesigned to comply with the new identity guidelines of NXP Semiconductors.</li> <li>Legal texts have been adapted to the new company name where appropriate.</li> </ul>			
BAV756S_BAW56_SER_5	20071126	Product data sheet	-	BAV756S_2 BAW56_4 BAW56S_2 BAW56T_2 BAW56W_4
BAV756S_2	19971021	Product specification	-	BAV756S_1
BAW56_4	20030325	Product specification	-	BAW56_3
BAW56S_2	19971021	Product specification	-	BAW56S_1
BAW56T_2	19971219	Product specification	-	-
BAW56W_4	19990511	Product specification	-	BAW56W_3

## 13. Legal information

### 13.1 Data sheet status

Document status <sup>[1][2]</sup>	Product status <sup>[3]</sup>	Definition
Objective [short] data sheet	Development	This document contains data from the objective specification for product development.
Preliminary [short] data sheet	Qualification	This document contains data from the preliminary specification.
Product [short] data sheet	Production	This document contains the product specification.

[1] Please consult the most recently issued document before initiating or completing a design.

[2] The term 'short data sheet' is explained in section "Definitions".

[3] The product status of device(s) described in this document may have changed since this document was published and may differ in case of multiple devices. The latest product status information is available on the Internet at URL <http://www.nexperia.com>.

### 13.2 Definitions

**Draft** — The document is a draft version only. The content is still under internal review and subject to formal approval, which may result in modifications or additions. Nexperia does not give any representations or warranties as to the accuracy or completeness of information included herein and shall have no liability for the consequences of use of such information.

**Short data sheet** — A short data sheet is an extract from a full data sheet with the same product type number(s) and title. A short data sheet is intended for quick reference only and should not be relied upon to contain detailed and full information. For detailed and full information see the relevant full data sheet, which is available on request via the local Nexperia sales office. In case of any inconsistency or conflict with the short data sheet, the full data sheet shall prevail.

**Product specification** — The information and data provided in a Product data sheet shall define the specification of the product as agreed between Nexperia and its customer, unless Nexperia and customer have explicitly agreed otherwise in writing. In no event however, shall an agreement be valid in which the Nexperia product is deemed to offer functions and qualities beyond those described in the Product data sheet.

### 13.3 Disclaimers

**Limited warranty and liability** — Information in this document is believed to be accurate and reliable. However, Nexperia does not give any representations or warranties, expressed or implied, as to the accuracy or completeness of such information and shall have no liability for the consequences of use of such information. Nexperia takes no responsibility for the content in this document if provided by an information source outside of Nexperia.

In no event shall Nexperia be liable for any indirect, incidental, punitive, special or consequential damages (including - without limitation - lost profits, lost savings, business interruption, costs related to the removal or replacement of any products or rework charges) whether or not such damages are based on tort (including negligence), warranty, breach of contract or any other legal theory.

Notwithstanding any damages that customer might incur for any reason whatsoever, Nexperia's aggregate and cumulative liability towards customer for the products described herein shall be limited in accordance with the *Terms and conditions of commercial sale* of Nexperia.

**Right to make changes** — Nexperia reserves the right to make changes to information published in this document, including without limitation specifications and product descriptions, at any time and without notice. This document supersedes and replaces all information supplied prior to the publication hereof.

**Suitability for use in automotive applications** — This Nexperia product has been qualified for use in automotive applications. Unless otherwise agreed in writing, the product is not designed, authorized or warranted to be suitable for use in life support, life-critical or safety-critical systems or equipment, nor in applications where failure or malfunction of a Nexperia product can reasonably be expected to result in personal injury, death or severe property or environmental damage. Nexperia and its suppliers accept no liability for inclusion and/or use of Nexperia products in such equipment or applications and therefore such inclusion and/or use is at the customer's own risk.

**Applications** — Applications that are described herein for any of these products are for illustrative purposes only. Nexperia makes no representation or warranty that such applications will be suitable for the specified use without further testing or modification.

Customers are responsible for the design and operation of their applications and products using Nexperia products, and Nexperia accepts no liability for any assistance with applications or customer product design. It is customer's sole responsibility to determine whether the Nexperia product is suitable and fit for the customer's applications and products planned, as well as for the planned application and use of customer's third party customer(s). Customers should provide appropriate design and operating safeguards to minimize the risks associated with their applications and products.

Nexperia does not accept any liability related to any default, damage, costs or problem which is based on any weakness or default in the customer's applications or products, or the application or use by customer's third party customer(s). Customer is responsible for doing all necessary testing for the customer's applications and products using Nexperia products in order to avoid a default of the applications and the products or of the application or use by customer's third party customer(s). Nexperia does not accept any liability in this respect.

**Limiting values** — Stress above one or more limiting values (as defined in the Absolute Maximum Ratings System of IEC 60134) will cause permanent damage to the device. Limiting values are stress ratings only and (proper) operation of the device at these or any other conditions above those given in the Recommended operating conditions section (if present) or the Characteristics sections of this document is not warranted. Constant or repeated exposure to limiting values will permanently and irreversibly affect the quality and reliability of the device.

**Terms and conditions of commercial sale** — Nexperia products are sold subject to the general terms and conditions of commercial sale, as published at <http://www.nexperia.com/profile/terms> unless otherwise agreed in a valid written individual agreement. In case an individual agreement is concluded only the terms and conditions of the respective agreement shall apply. Nexperia hereby expressly objects to applying the customer's general terms and conditions with regard to the purchase of Nexperia products by customer.

**No offer to sell or license** — Nothing in this document may be interpreted or construed as an offer to sell products that is open for acceptance or the grant, conveyance or implication of any license under any copyrights, patents or other industrial or intellectual property rights.

**Quick reference data** — The Quick reference data is an extract of the product data given in the Limiting values and Characteristics sections of this document, and as such is not complete, exhaustive or legally binding.

**Export control** — This document as well as the item(s) described herein may be subject to export control regulations. Export might require a prior authorization from competent authorities.

**Translations** — A non-English (translated) version of a document is for reference only. The English version shall prevail in case of any discrepancy between the translated and English versions.

## 13.4 Trademarks

Notice: All referenced brands, product names, service names and trademarks are the property of their respective owners.

## 14. Contact information

---

For more information, please visit: <http://www.nexperia.com>

For sales office addresses, please send an email to: [salesaddresses@nexperia.com](mailto:salesaddresses@nexperia.com)



## 15. Contents

---

<b>1</b>	<b>Product profile</b> . . . . .	<b>1</b>
1.1	General description . . . . .	1
1.2	Features and benefits . . . . .	1
1.3	Applications . . . . .	1
1.4	Quick reference data . . . . .	1
<b>2</b>	<b>Pinning information</b> . . . . .	<b>2</b>
<b>3</b>	<b>Ordering information</b> . . . . .	<b>3</b>
<b>4</b>	<b>Marking</b> . . . . .	<b>3</b>
<b>5</b>	<b>Limiting values</b> . . . . .	<b>3</b>
<b>6</b>	<b>Thermal characteristics</b> . . . . .	<b>4</b>
<b>7</b>	<b>Characteristics</b> . . . . .	<b>5</b>
<b>8</b>	<b>Test information</b> . . . . .	<b>7</b>
8.1	Quality information . . . . .	7
<b>9</b>	<b>Package outline</b> . . . . .	<b>8</b>
<b>10</b>	<b>Packing information</b> . . . . .	<b>9</b>
<b>11</b>	<b>Soldering</b> . . . . .	<b>9</b>
<b>12</b>	<b>Revision history</b> . . . . .	<b>13</b>
<b>13</b>	<b>Legal information</b> . . . . .	<b>14</b>
13.1	Data sheet status . . . . .	14
13.2	Definitions . . . . .	14
13.3	Disclaimers . . . . .	14
13.4	Trademarks . . . . .	15
<b>14</b>	<b>Contact information</b> . . . . .	<b>15</b>
<b>15</b>	<b>Contents</b> . . . . .	<b>16</b>

## Looking for pricing, stock, or lifecycle information?

Click below to explore more details on WIN SOURCE:

-  [View BAV756S,115 on WIN SOURCE](#)
-  [Nexperia USA Inc. Information](#)

## Optimize Your Supply Chain with WIN SOURCE Solutions

-  Global Sourcing Solution
-  Obsolete Management
-  Cost Control Management
-  Shortage Management
-  Alternative Solution
-  Excess Inventory Management