



THE DATASHEET OF STPS140ZY



Automotive power Schottky rectifier

Datasheet - production data

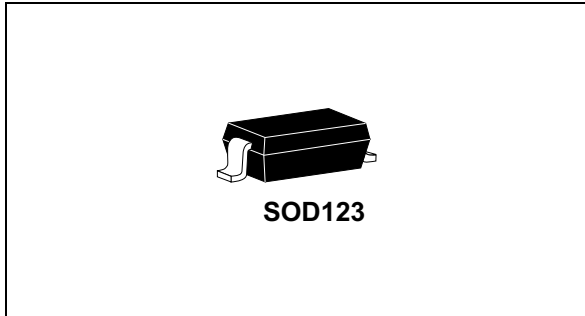
**Description**

This single Schottky rectifier is suited for switch mode power supplies and high frequency DC to DC converters.

Packaged in SOD-123, this device is intended for use in low voltage, high frequency inverters, free wheeling and polarity protection for automotive applications.

Table 1. Device summary

Symbol	Value
$I_{F(AV)}$	1 A
V_{RRM}	40 V
T_j (max)	150 °C
V_F (max)	0.51 V

Features

- Very small conduction losses
- Negligible switching losses
- Extremely fast switching
- ECOPACK[®]2 compliant component
- AEC-Q101 qualified

1 Characteristics

Table 2. Absolute Ratings (limiting values)

Symbol	Parameter	Value	Unit
V_{RRM}	Repetitive peak reverse voltage	40	V
I_F	Continuous forward current	$T_{amb} = 60\text{ °C}$	A
I_{FSM}	Surge non repetitive forward current	$t_p = 10\text{ ms sinusoidal}$	A
I_{RRM}	Repetitive peak reverse current	$t_p = 2\text{ }\mu\text{s F} = 1\text{ kHz square}$	A
I_{RSM}	Non repetitive peak reverse current	$t_p = 100\text{ }\mu\text{s square}$	A
T_{stg}	Storage temperature range	- 65 to + 150	°C
T_j	Operating junction temperature ⁽¹⁾	- 40 to + 150	°C
dV/dt	Critical rate of rise of reverse voltage	10000	V/ μs

1. $\frac{dP_{tot}}{dT_j} < \frac{1}{R_{th(j-a)}}$ condition to avoid thermal runaway for a diode on its own heatsink

Table 3. Thermal resistance

Symbol	Parameter	Value	Unit
$R_{th(j-a)}$	Junction to ambient ⁽¹⁾	500	°C/W

1. Mounted on epoxy board.

Table 4. Static electrical characteristics

Symbol	Parameter	Test conditions	Min.	Typ.	Max.	Unit
$I_R^{(1)}$	Reverse leakage current	$T_j = 25\text{ °C}$ $V_R = 5\text{ V}$			10	μA
		$T_j = 25\text{ °C}$ $V_R = 40\text{ V}$			40	
		$T_j = 100\text{ °C}$ $V_R = 40\text{ V}$		1.5	5	mA
$V_F^{(2)}$	Forward voltage drop	$T_j = 25\text{ °C}$ $I_F = 1\text{ A}$			0.55	V
		$T_j = 100\text{ °C}$ $I_F = 1\text{ A}$		0.45	0.51	

1. Pulse test: $t_p = 5\text{ ms}$, $\delta < 2\%$

2. Pulse test: $t_p = 380\text{ ms}$, $\delta < 2\%$

To evaluate the maximum conduction losses use the following equation:

$$P = 0.2 \times I_{F(AV)} + 0.3 \times I_{F(RMS)}^2 \text{ at } T_j = 150\text{ °C}$$

Figure 1. Average forward power dissipation versus average forward current

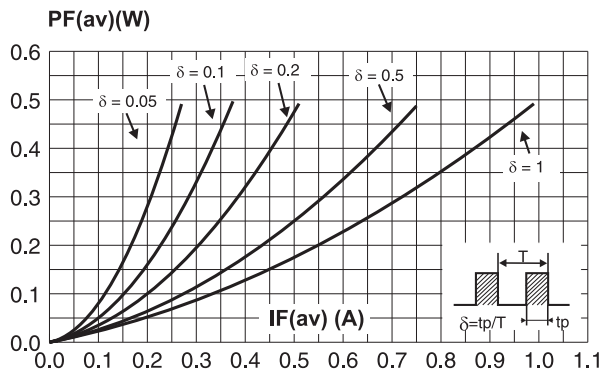

Figure 2. Average forward current versus ambient temperature ($\delta = 1$)

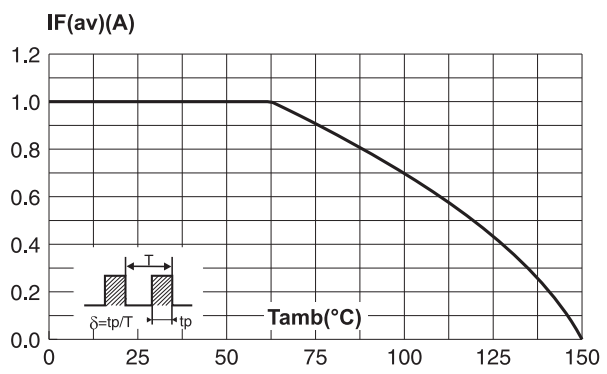

Figure 3. Non repetitive surge peak forward current versus overload duration (maximum values)

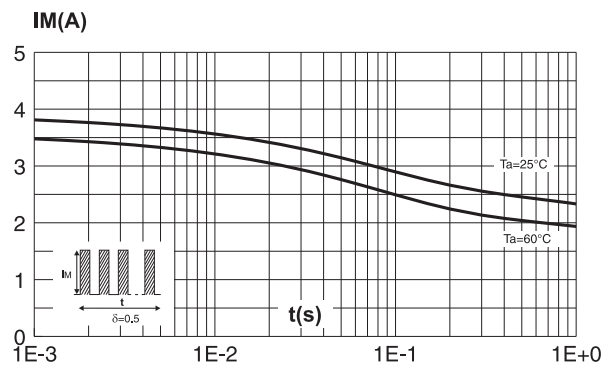

Figure 4. Relative variation of thermal impedance junction to ambient versus pulse duration

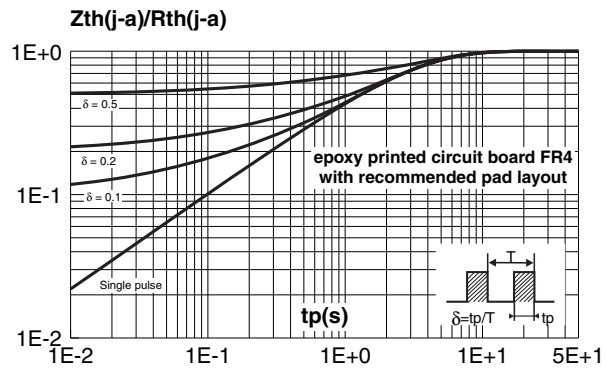

Figure 5. Reverse leakage current versus reverse voltage applied (typical value)

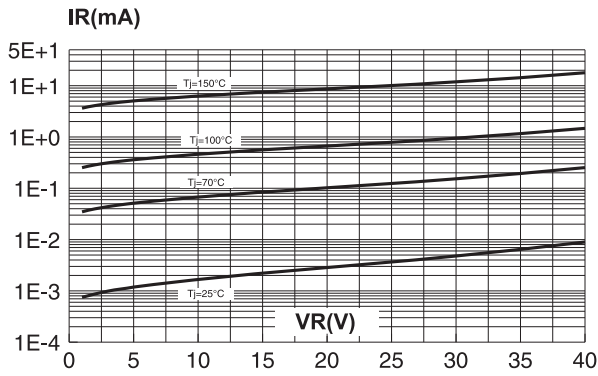

Figure 6. Reverse leakage current versus junction temperature (typical value)

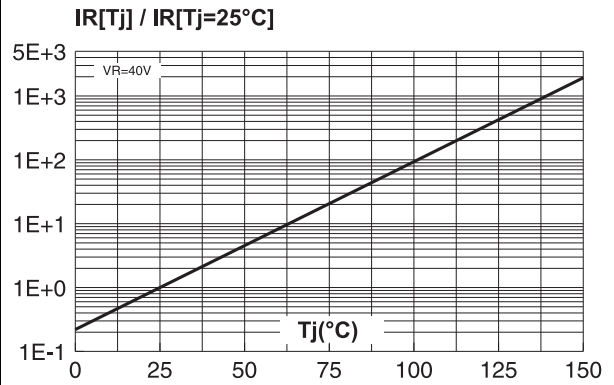

Figure 7. Junction capacitance versus reverse voltage applied (typical value)

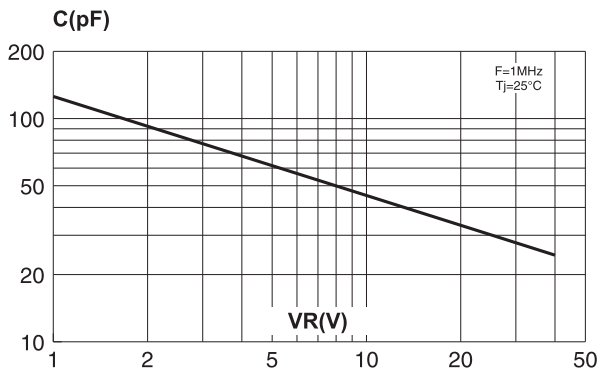

Figure 8. Forward voltage drop versus forward current (high level, maximum values)

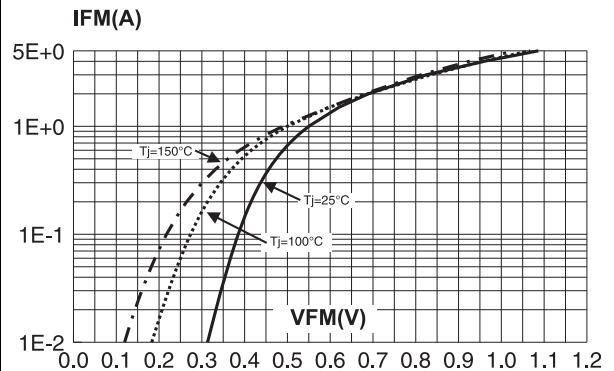
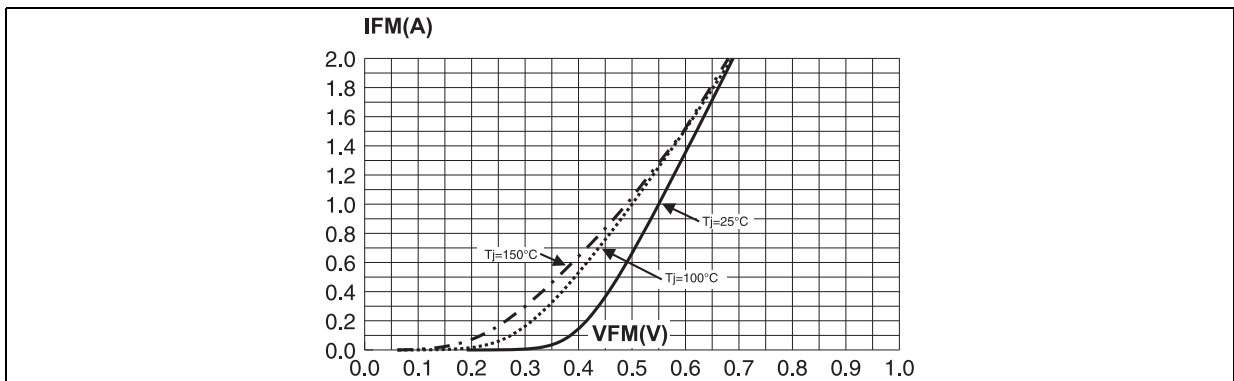

Figure 9. Forward voltage drop versus forward current (low level, maximum values)



2 Package Information

- Epoxy meets UL94,V0
- Lead-free packages

In order to meet environmental requirements, ST offers these devices in different grades of ECOPACK[®] packages, depending on their level of environmental compliance. ECOPACK[®] specifications, grade definitions and product status are available at: www.st.com. ECOPACK[®] is an ST trademark.

2.1 SOD-123 package information

Figure 10. SOD123 package outline

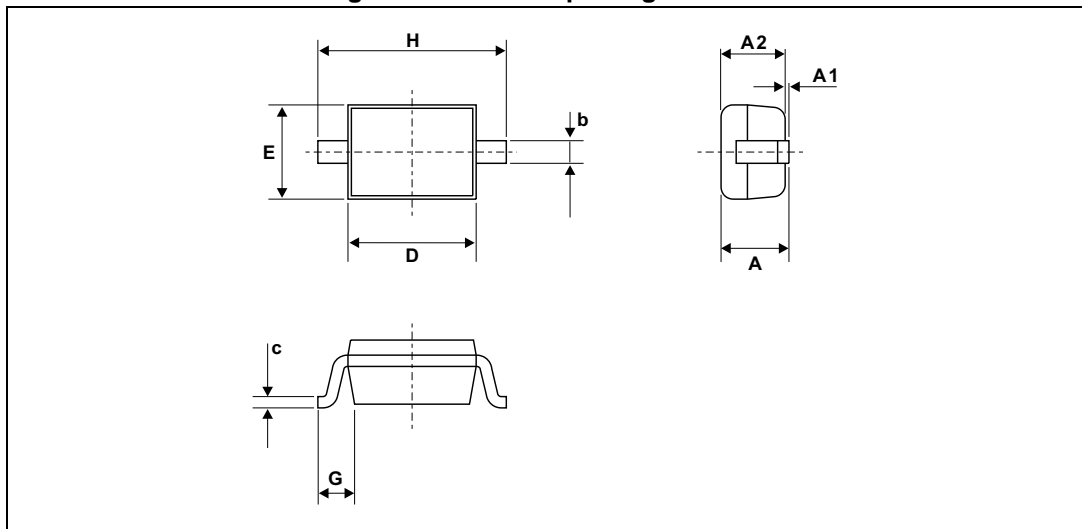
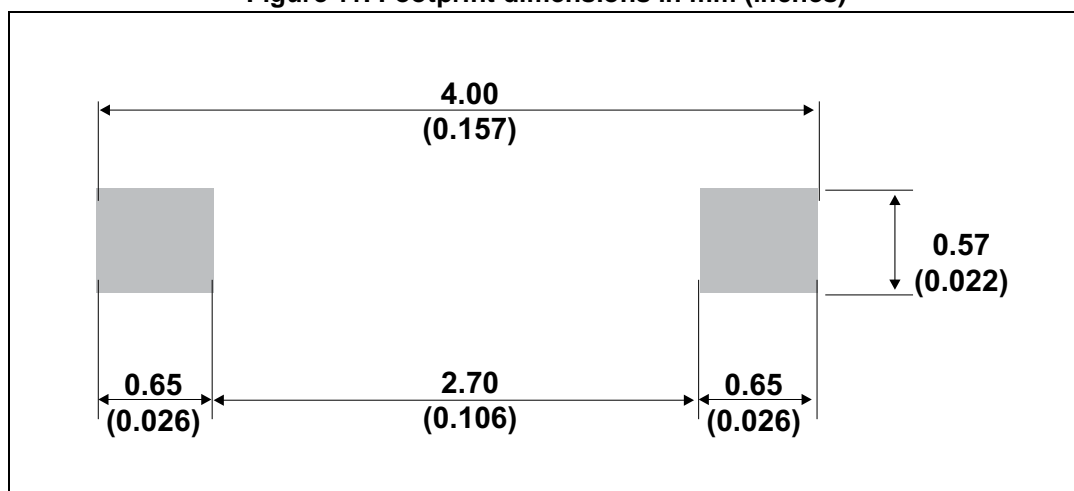

Table 5. SOD123 package mechanical data

Ref.	Dimensions					
	Millimeters			Inches		
	Min.	Typ.	Max.	Min.	Typ.	Max.
A			1.45			0.057
A1	0		0.1	0		0.004
A2	0.85		1.35	0.033		0.053
b		0.55			0.022	
c		0.15			0.039	
D	2.55		2.85	0.1		0.112
E	1.4		1.7	0.055		0.067
G	0.25			0.01		
H	3.55		3.75	0.14		0.148

Figure 11. Footprint dimensions in mm (inches)



3 Ordering information

Table 6. Ordering information

Order code	Marking	Package	Weight	Base qty	Delivery mode
STPS140ZY	Z1Y	SOD-123	0.01 g	3000	Tape and reel

4 Revision history

Table 7. Document revision history

Date	Revision	Changes
24-Oct-2012	1	First issue.
07-Jul-2015	2	Updated Table 4 and reformatted to current standard.

IMPORTANT NOTICE – PLEASE READ CAREFULLY

STMicroelectronics NV and its subsidiaries (“ST”) reserve the right to make changes, corrections, enhancements, modifications, and improvements to ST products and/or to this document at any time without notice. Purchasers should obtain the latest relevant information on ST products before placing orders. ST products are sold pursuant to ST’s terms and conditions of sale in place at the time of order acknowledgement.

Purchasers are solely responsible for the choice, selection, and use of ST products and ST assumes no liability for application assistance or the design of Purchasers’ products.

No license, express or implied, to any intellectual property right is granted by ST herein.

Resale of ST products with provisions different from the information set forth herein shall void any warranty granted by ST for such product.



ST and the ST logo are trademarks of ST. All other product or service names are the property of their respective owners.

Information in this document supersedes and replaces information previously supplied in any prior versions of this document.

© 2015 STMicroelectronics – All rights reserved

Looking for pricing, stock, or lifecycle information?

Click below to explore more details on WIN SOURCE:

-  [View STPS140ZY on WIN SOURCE](#)
-  [STMicroelectronics Information](#)

Optimize Your Supply Chain with WIN SOURCE Solutions

-  Global Sourcing Solution
-  Obsolete Management
-  Cost Control Management
-  Shortage Management
-  Alternative Solution
-  Excess Inventory Management