



**THE DATASHEET OF
CPDT6-5V4-HF**



CPDT6-5V4-HF

RoHS Device
Halogen Free

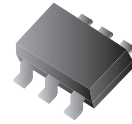

Features

- Common anode ESD protection.
- IEC61000-4-2 Level 4 ESD protection.
- Low operating voltage: < 5V.
- Fast turn-on and low clamping voltage.

Mechanical data

- Case: SOT-23-6 Standard package, molded plastic.
- Terminals: Tin plated, solderable per MIL-STD-750, method 2026.
- Marking code:E5V4
- Mounting position: Any.
- Weight: 0.015 gram(approx.).

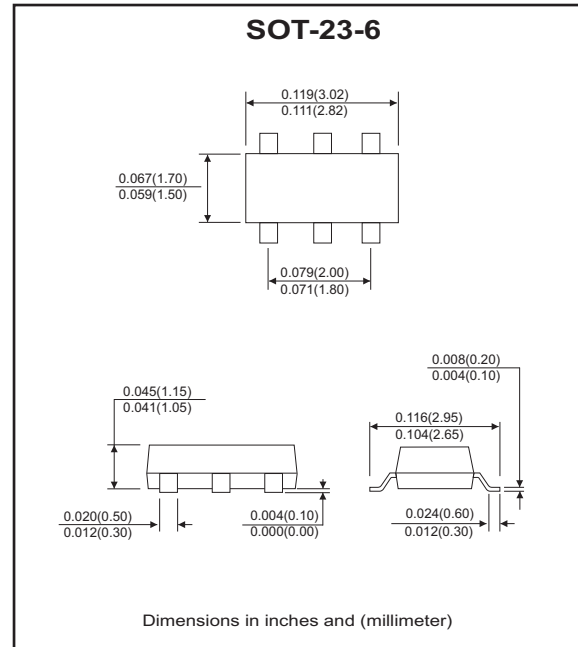

Circuit diagram

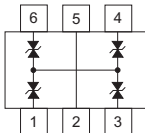

Electrical Characteristics (at TA=25°C unless otherwise noted)

Parameter	Conditions	Symbol	Min	Typ	Max	Unit
Diode breakdown voltage	I _R = 1mA	V _{BD}	5.1	7.0		V
Leakage current	V _R = 5V	I _L		0.1	2.0	uA
Junction capacitance	V _R =0V,f =1MHz	C _T		15	20	pF
ESD capability	IEC 61000-4-2(air) IEC 61000-4-2(contact)	ESD			16 8	kV
Clamping voltage	I _{PP} = 5A,T _P =8/20us	V _C			15	V
Peak pulse power	T _P =8/20us	P _{PP}			75	W
Operation temperature		T _j	-40		125	°C
Storage temperature		T _{STG}	-55		150	°C

RATING AND CHARACTERISTIC CURVES (CPDT6-5V4-HF)

Fig. 1 - 8/20us Peak pulse current wave form acc. IEC 61000-4-5

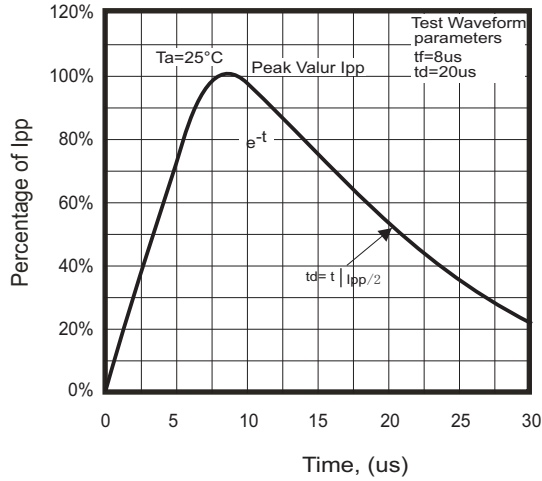

Fig. 2 - Reverse characteristics

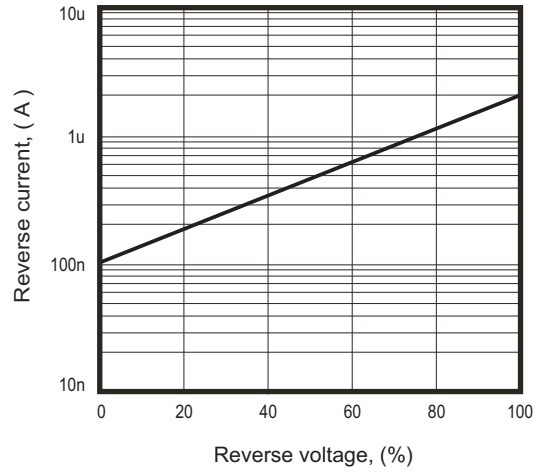

Fig.3 - Capacitance between terminals characteristics

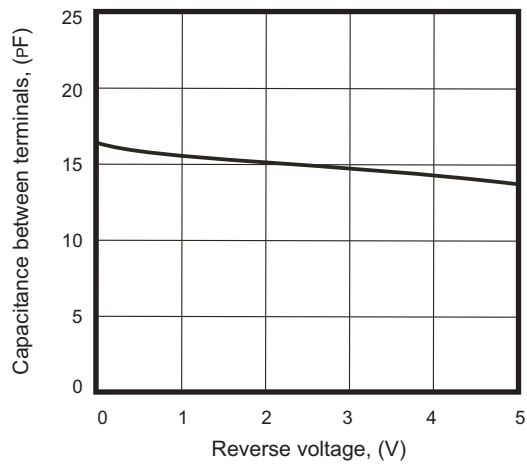
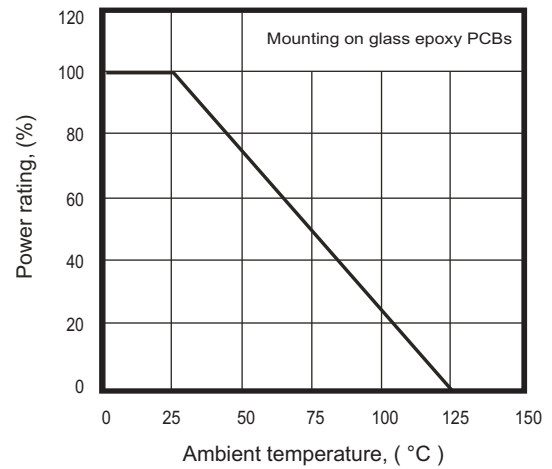
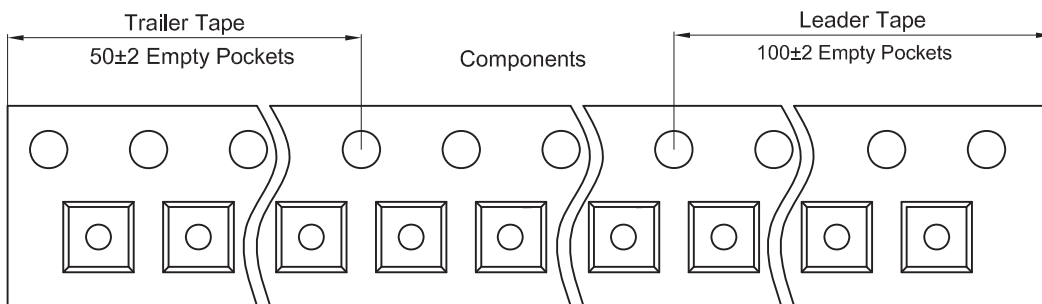
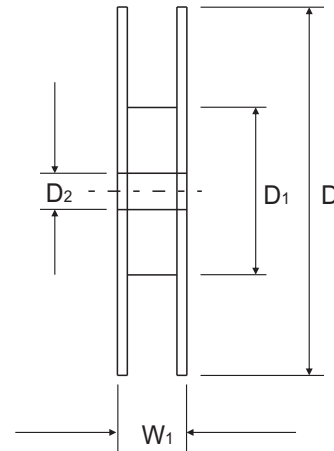
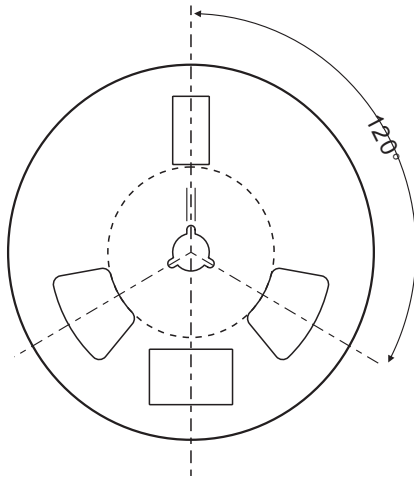
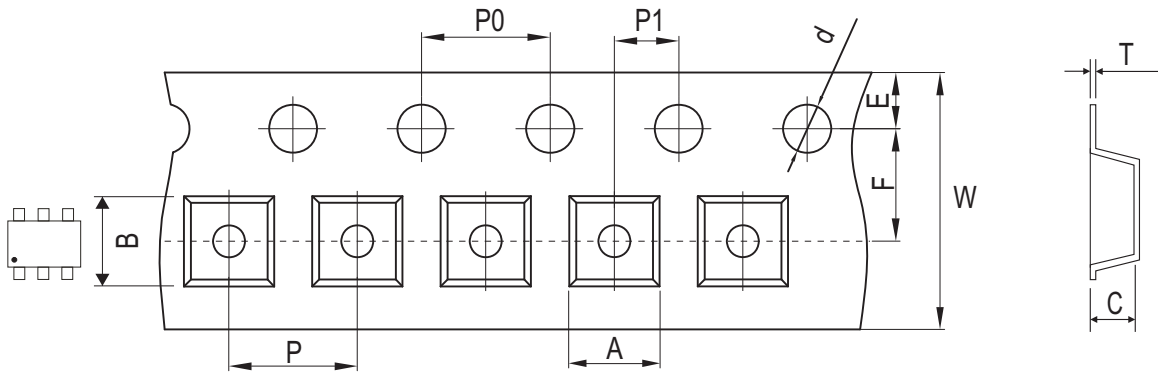

Fig.4 - Power rating derating curve



Reel Taping Specification



SOT-23-6	SYMBOL	A	B	C	d	D	D1	D2
	(mm)	3.17 ± 0.10	3.23 ± 0.10	1.37 ± 0.10	1.50 ± 0.05	180.0 + 0.00 / - 0.30	60.00 ± 0.50	13.00 ± 0.20
	(inch)	0.125 ± 0.004	0.127 ± 0.004	0.054 ± 0.004	0.059 ± 0.002	7.087 + 0.00 / - 0.012	2.362 ± 0.020	0.512 ± 0.008

SOT-23-6	SYMBOL	E	F	P	P0	P1	W	W1
	(mm)	1.75 ± 0.10	3.50 ± 0.05	4.00 ± 0.10	4.00 ± 0.10	2.00 ± 0.05	8.00 + 0.30 / - 0.10	12.30 ± 0.20
	(inch)	0.069 ± 0.004	0.138 ± 0.002	0.157 ± 0.004	0.157 ± 0.004	0.079 ± 0.002	0.315 + 0.012 / - 0.004	0.484 ± 0.008

Marking Code

Part Number	Marking Code
CPDT6-5V4-HF	E5V4

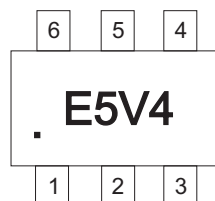

Suggested PAD Layout

SIZE	SOT-23-6	
	(mm)	(inch)
A	1.10	0.043
B	0.60	0.024
C	1.90	0.075
D	2.50	0.098
E	3.60	0.142

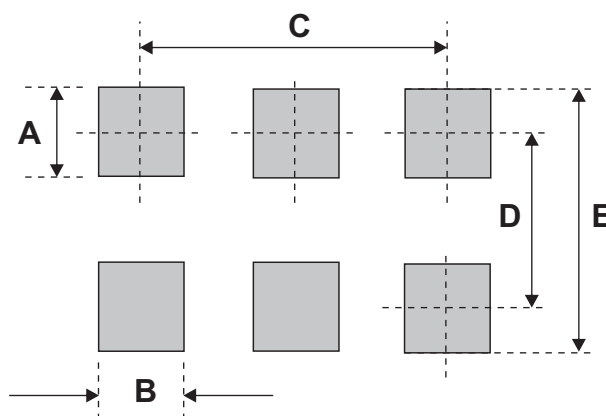

Standard Packaging

Case Type	REEL PACK	
	REEL (pcs)	Reel Size (inch)
SOT-23-6	3,000	7

Looking for pricing, stock, or lifecycle information?

Click below to explore more details on WIN SOURCE:

-  [View CPDT6-5V4-HF on WIN SOURCE](#)
-  [Comchip Technology Information](#)

Optimize Your Supply Chain with WIN SOURCE Solutions

-  Global Sourcing Solution
-  Obsolete Management
-  Cost Control Management
-  Shortage Management
-  Alternative Solution
-  Excess Inventory Management