



**THE DATASHEET OF
BQ24705RGERG4**



600-kHz, Host-Controlled Multi-Cell Battery Charger With Input Overvoltage Protection

FEATURES

- **NMOS-NMOS Synchronous Buck Converter with 600 kHz Frequency and >95% Efficiency**
- **30-ns Minimum Driver Dead-time and 99.5% Maximum Effective Duty Cycle**
- **High-Accuracy Voltage and Current Regulation**
 - **±0.5% Charge Voltage Accuracy**
 - **±3% Charge Current Accuracy**
 - **±3% Adapter Current Accuracy**
 - **±2% Input Current Sense Amp Accuracy**
- **Integration**
 - **Internal Loop Compensation**
 - **Internal Soft-Start**
- **Safety**
 - **Input Overvoltage Protection (OVP)**
 - **Dynamic Power Management (DPM) with Status Indicator**
- **Supports Two, Three, or Four Li+ Cells**
- **5 – 24 V AC/DC-Adapter Operating Range**
- **Analog Inputs with Ratiometric Programming via Resistors or DAC/GPIO Host Control**
 - **Charge Voltage (4-4.512 V/cell)**
 - **Charge Current (up to 8 A, with 10-mΩ Sense Resistor)**
 - **Adapter Current Limit (DPM)**
- **Status and Monitoring Outputs**
 - **AC/DC Adapter Present with Programmable Voltage Threshold**
 - **DPM Loop Active (DPMDET)**
 - **Current Drawn from Input Source**
- **Supports Any Battery Chemistry: Li+, NiCd, NiMH, Lead Acid, etc.**
- **Charge Enable**
- **10-μA Off-State Battery Current**
- **24-pin, 4x4-mm QFN Package**

APPLICATIONS

- **Notebook and Ultra-Mobile Computers**
- **Portable Data-Capture Terminals**
- **Portable Printers**
- **Medical Diagnostics Equipment**
- **Battery Bay Chargers**
- **Battery Back-Up Systems**

DESCRIPTION

The bq24705 is a high-efficiency, synchronous battery charger with integrated compensation, offering low component count for space-limited multi-chemistry battery charging applications. Charge current and voltage programming allows high regulation accuracies, and can be either hardwired with resistors, or programmed by the system power-management microcontroller using a DAC or GPIOs.

The bq24705 charges two, three, or four series Li+ cells, supporting up to 8 A of charge current, and is available in a 24-pin, 4x4-mm thin QFN package.

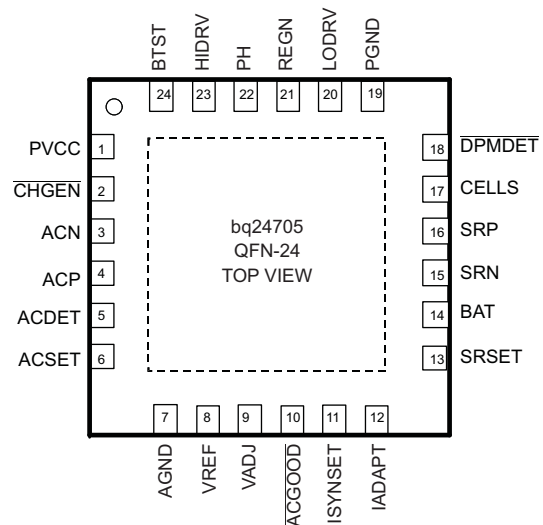
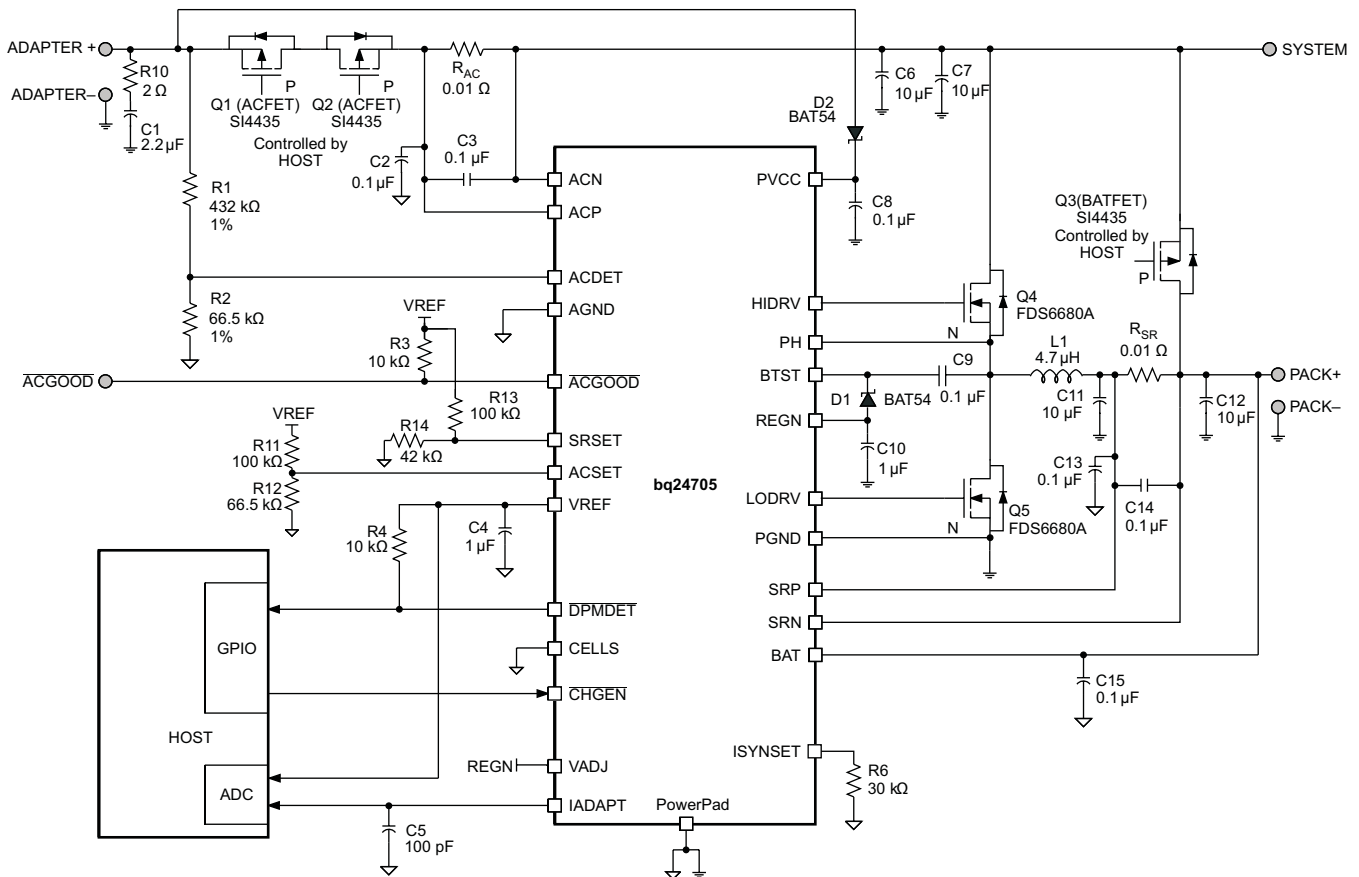

Figure 1. bq24705, 24 LD QFN, Top View



Please be aware that an important notice concerning availability, standard warranty, and use in critical applications of Texas Instruments semiconductor products and disclaimers thereto appears at the end of this data sheet.

PowerPad is a trademark of Texas Instruments.



- (1) Pull-up rail could be either VREF or other system rail.
- (2) SRSET/ACSET could come from either DAC or resistor dividers.
- (3) $V_{IN} = 20\text{ V}$, $V_{BAT} = 3\text{-cell Li-Ion}$, $I_{CHARGE} = 3\text{ A}$, $I_{ADAPTER_LIMIT} = 4\text{ A}$

Figure 3. Typical System Schematic, Voltage and Current Programmed by Resistor

ORDERING INFORMATION

Part Number	Package	Ordering Number (Tape and Reel)	Quantity
bq24705	24-PIN 4 x 4 mm QFN	bq24705RGER	3000
		bq24705RGET	250

PACKAGE THERMAL DATA

PACKAGE	θ_{JA}	$T_A=70^\circ\text{C}$ POWER RATING	DERATING FACTOR ABOVE $T_A=25^\circ\text{C}$
QFN – RGE ⁽¹⁾⁽²⁾	45°C/W	2.33 W	0.023 W/°C

- (1) For the most current package and ordering information, see the Package Option Addendum at the end of this document, or see the TI Web site at www.ti.com.
- (2) This data is based on using the JEDEC High-K board and the exposed die pad is connected to a Cu pad on the board. This is connected to the ground plane by a 2x3 via matrix.

Table 1. TERMINAL FUNCTIONS – 24-PIN QFN

TERMINAL		DESCRIPTION
NAME	NO.	
PVCC	1	IC power positive supply. Place a 0.1- μ F ceramic capacitor from PVCC to PGND pin close to the IC.
CHGEN	2	Charge enable active-low logic input. LO enables charge. HI disables charge.
ACN	3	Adapter current sense resistor, negative input. A 0.1- μ F ceramic capacitor is placed from ACN to ACP to provide ACN 2 differential-mode filtering. An optional 0.1- μ F ceramic capacitor is placed from ACN pin to AGND for common-mode filtering.
ACP	4	Adapter current sense resistor, positive input. A 0.1- μ F ceramic capacitor is placed from ACN to ACP to provide differential-mode filtering. A 0.1- μ F ceramic capacitor is placed from ACP pin to AGND for common-mode filtering.
ACDET	5	Adapter detected voltage set input. Program the adapter detect threshold by connecting a resistor divider from adapter input to ACDET pin to AGND pin. Adapter voltage is detected if ACDET-pin voltage is greater than 2.4 V. The I_{ADAPT} current sense amplifier is active when the ACDET pin voltage is greater than 0.6 V. ACOV is input overvoltage protection. It disables charge when ACDET > 3.1 V. ACOV does not latch and normal charge resumes when ACDET < 3.1V.
ACSET	6	Adapter current set input. The voltage ratio of ACSET voltage versus VREF voltage programs the input current regulation set-point during Dynamic Power Management (DPM). Program by connecting a resistor divider from VREF to ACSET to AGND; or by connecting the output of an external DAC to the ACSET pin.
AGND	7	Analog ground. Ground connection for low-current sensitive analog and digital signals. On PCB layout, connect to the analog ground plane, and only connect to PGND through the PowerPad underneath the IC.
VREF	8	3.3-V regulated voltage output. Place a 1- μ F ceramic capacitor from VREF to AGND pin close to the IC. This voltage could be used for ratiometric programming of voltage and current regulation. VREF is the source for the internal circuit.
VADJ	9	Charge voltage set input. The voltage ratio of VADJ voltage versus VREF voltage programs the battery voltage regulation set-point. Program by connecting a resistor divider from VREF to VADJ, to AGND; or, by connecting the output of an external DAC to VADJ. VADJ connected to REGN programs the default of 4.2 V per cell.
ACGOOD	10	Valid adapter active-low detect logic open-drain output. Pulled low when input voltage is above ACDET programmed threshold. Connect a 10-k Ω pullup resistor from ACGOOD pin to pullup supply rail.
ISYNSET	11	Synchronous mode current set input. Place a resistor from ISYNSET to AGND to program the charge undercurrent threshold to force non-synchronous converter operation at low output current, and to prevent negative inductor current. Threshold should be set at greater than half of the maximum inductor ripple current (50% duty cycle).
IADAPT	12	Adapter current sense amplifier output. IADAPT voltage is 20 times the differential voltage across ACP-ACN. Place a 100-pF or less ceramic decoupling capacitor from IADAPT to AGND.
SRSET	13	Charge current set input. The voltage ratio of SRSET voltage versus VREF voltage programs the charge current regulation set-point. Program by connecting a resistor divider from VREF to SRSET to AGND; or by connecting the output of an external DAC to SRSET pin.
BAT	14	Battery voltage remote sense. Directly connect a kelvin sense trace from the battery pack positive terminal to the BAT pin to accurately sense the battery pack voltage. Place a 0.1- μ F capacitor from BAT to AGND close to the IC to filter high-frequency noise.
SRN	15	Charge current sense resistor, negative input. A 0.1- μ F ceramic capacitor is placed from SRN to SRP to provide differential-mode filtering. An optional 0.1- μ F ceramic capacitor is placed from SRN pin to AGND for common-mode filtering.
SRP	16	Charge current sense resistor, positive input. A 0.1- μ F ceramic capacitor is placed from SRN to SRP to provide differential-mode filtering. A 0.1- μ F ceramic capacitor is placed from SRP pin to AGND for common-mode filtering.
CELLS	17	2, 3 or 4 cells selection logic input. Logic low programs 3 cell. Logic high programs 4 cell. Floating programs 2 cell.
DPMDDET	18	Dynamic power management (DPM) input current loop active, open-drain output status. Logic low indicates input current is being limited by reducing the charge current. Connect 10-k Ω pullup resistor from DPMDDET to VREF or a different pullup-supply rail.
PGND	19	Power ground. Ground connection for high-current power converter node. On PCB layout, connect directly to source of low-side power MOSFET, to ground connection of in put and output capacitors of the charger. Only connect to AGND through the PowerPad underneath the IC.
LODRV	20	PWM low side driver output. Connect to the gate of the low-side power MOSFET with a short trace.
REGN	21	PWM low side driver positive 6-V supply output. Connect a 1- μ F ceramic capacitor from REGN to PGND, close to the IC. Use for high-side driver bootstrap voltage by connecting a small-signal Schottky diode from REGN to BTST.
PH	22	PWM high side driver negative supply. Connect to the phase switching node (junction of the low-side power MOSFET drain, high-side power MOSFET source, and output inductor). Connect the 0.1- μ F bootstrap capacitor from from PH to BTST.
HIDRV	23	PWM high side driver output. Connect to the gate of the high-side power MOSFET with a short trace.
BTST	24	PWM high side driver positive supply. Connect a 0.1- μ F bootstrap ceramic capacitor from BTST to PH. Connect a small bootstrap Schottky diode from REGN to BTST.

Table 1. TERMINAL FUNCTIONS – 24-PIN QFN (continued)

TERMINAL		DESCRIPTION
NAME	NO.	
PowerPad™		Exposed pad beneath the IC. AGND and PGND star-connected only at the PowerPad plane. Always solder PowerPad to the board, and have vias on the PowerPad plane connecting to AGND and PGND planes. It also serves as a thermal pad to dissipate the heat.

ABSOLUTE MAXIMUM RATINGS

 over operating free-air temperature range (unless otherwise noted)^{(1) (2)}

		VALUE	UNIT
Voltage range	PVCC, ACP, ACN, SRP, SRN, BAT	–0.3 to 30	V
	PH	–1 to 30	
	REGN, LODRV, VADJ, ACSET, SRSET, ACDET, ISYNSET, CHGEN, CELLS, ACGOOD, DPMDDET, IADAPT	–0.3 to 7	
	VREF	–0.3 to 3.6	
	BTST, HIDRV with respect to AGND and PGND	–0.3 to 36	
Maximum difference voltage	ACP–ACN, SRP–SRN, AGND–PGND	–0.5 to 0.5	V
Junction temperature range		–40 to 155	°C
Storage temperature range		–55 to 155	

- (1) Stresses beyond those listed under *absolute maximum ratings* may cause permanent damage to the device. These are stress ratings only, and functional operation of the device at these or any other conditions beyond those indicated under *recommended operating conditions* is not implied. Exposure to absolute-maximum-rated conditions for extended periods may affect device reliability.
- (2) All voltages are with respect to GND if not specified. Currents are positive into, negative out of the specified terminal. Consult Packaging Section of the data book for thermal limitations and considerations of packages.

RECOMMENDED OPERATING CONDITIONS

over operating free-air temperature range (unless otherwise noted)

		MIN	NOM	MAX	UNIT
Voltage range	PH	–1		24	V
	PVCC, ACP, ACN, SRP, SRN, BAT	0		24	
	REGN, LODRV, VADJ	0		6.5	
	VREF	0		3.3	
	ACSET, SRSET, ACDET, ISYNSET, CHGEN, CELLS, ACGOOD, DPMDDET, IADAPT	0		5.5	
	BTST, HIDRV with respect to AGND and PGND	0		30	
	AGND, PGND	–0.3		0.3	
Maximum difference voltage: ACP–ACN, SRP–SRN	–0.3		0.3	V	
Junction temperature range		–40		125	°C
Storage temperature range		–55		150	

ELECTRICAL CHARACTERISTICS

7 V ≤ V_{PVCC} ≤ 24 V, 0°C < T_J < +125°C, typical values are at T_A = 25°C, with respect to AGND (unless otherwise noted)

PARAMETER	TEST CONDITIONS	MIN	TYP	MAX	UNIT		
OPERATING CONDITIONS							
V _{PVCC_OP}	PVCC Input voltage operating range	5		24	V		
CHARGE VOLTAGE REGULATION							
V _{BAT_REG_RNG}	BAT voltage regulation range	4V-4.512V per cell, times 2,3,4 cell		8	18	V	
V _{ADJ_OP}	VADJ voltage range	0		REGN	V		
Charge voltage regulation accuracy	Charge voltage regulation accuracy	8 V, 8.4 V, 9.024 V		-0.5%	0.5%		
		12 V, 12.6 V, 13.536 V		-0.5%	0.5%		
		16 V, 16.8 V, 18.048 V		-0.5%	0.5%		
Charge voltage regulation set to default to 4.2 V per cell		VADJ connected to REGN, 8.4 V, 12.6 V, 16.8 V		-0.5%	0.5%		
CHARGE CURRENT REGULATION							
V _{IREG_CHG}	Charge current regulation differential voltage range	V _{IREG_CHG} = V _{SRP} - V _{SRN}		0	100	mV	
V _{SRSET_OP}	SRSET voltage range	0		VREF	V		
Charge current regulation accuracy	Charge current regulation accuracy	V _{IREG_CHG} = 40–100 mV		-3%	3%		
		V _{IREG_CHG} = 20 mV		-5%	5%		
		V _{IREG_CHG} = 5 mV		-25%	25%		
		V _{IREG_CHG} = 1.5 mV (V _{BAT} ≥ 4V)		-33%	33%		
INPUT CURRENT REGULATION							
V _{IREG_DPM}	Adapter current regulation differential voltage range	V _{IREG_DPM} = V _{ACP} - V _{ACN}		0	100	mV	
V _{ACSET_OP}	ACSET voltage range	0		VREF	V		
Input current regulation accuracy	Input current regulation accuracy	V _{IREG_DPM} = 40–100 mV		-3%	3%		
		V _{IREG_DPM} = 20 mV		-5%	5%		
		V _{IREG_DPM} = 5 mV		-25%	25%		
		V _{IREG_DPM} = 1.5 mV		-33%	33%		
VREF REGULATOR							
V _{VREF_REG}	VREF regulator voltage	V _{ACDET} > 0.6 V, 0-30 mA		3.267	3.3	3.333	V
I _{VREF_LIM}	VREF current limit	V _{VREF} = 0 V, V _{ACDET} > 0.6 V		35		75	mA
REGN REGULATOR							
V _{REGN_REG}	REGN regulator voltage	V _{ACDET} > 0.6 V, 0-75 mA, PVCC > 10 V		5.6	5.9	6.2	V
I _{REGN_LIM}	REGN current limit	V _{REGN} = 0 V, V _{ACDET} > 0.6 V		90		135	mA
ADAPTER CURRENT SENSE AMPLIFIER							
V _{ACP/N_OP}	Input common mode range	Voltage on ACP/ACN		0		24	V
V _{IADAPT}	IADAPT output voltage range			0		2	V
I _{IADAPT}	IADAPT output current			0		1	mA
A _{IADAPT}	Current sense amplifier voltage gain	A _{IADAPT} = V _{IADAPT} / V _{IREG_DPM}		20			V/V
Adapter current sense accuracy	Adapter current sense accuracy	V _{IREG_DPM} = 40–100 mV		-2%	2%		
		V _{IREG_DPM} = 20 mV		-3%	3%		
		V _{IREG_DPM} = 5 mV		-25%	25%		
		V _{IREG_DPM} = 1.5 mV		-30%	30%		
I _{IADAPT_LIM}	Output current limit	V _{IADAPT} = 0 V		1			mA
C _{IADAPT_MAX}	Maximum output load capacitance	For stability with 0 mA to 1 mA load				100	pF

ELECTRICAL CHARACTERISTICS (continued)

 7 V ≤ V_{PVCC} ≤ 24 V, 0°C < T_J < +125°C, typical values are at T_A = 25°C, with respect to AGND (unless otherwise noted)

PARAMETER		TEST CONDITIONS	MIN	TYP	MAX	UNIT
ACDET COMPARATOR						
V _{PVCC-BAT_OP}	Differential Voltage from PVCC to BAT		-20		24	V
V _{ACDET_CHG}	ACDET adapter-detect rising threshold	Min voltage to enable charging, V _{ACDET} rising	2.376	2.40	2.424	V
V _{ACDET_CHG_HYS}	ACDET falling hysteresis	V _{ACDET} falling		40		mV
	ACDET rising deglitch ⁽¹⁾	V _{ACDET} rising	6.4	8	9.6	ms
	ACDET falling deglitch	V _{ACDET} falling		10		μs
V _{ACDET_BIAS}	ACDET enable-bias rising threshold	Min voltage to enable all bias, V _{ACDET} rising	0.56	0.62	0.68	V
V _{ACDET_BIAS_HYS}	Adapter present falling hysteresis	V _{ACDET} falling		20		mV
	ACDET_BIAS rising deglitch ⁽¹⁾	V _{ACDET} rising		10		μs
	ACDET_BIAS falling deglitch	V _{ACDET} falling		10		
OPEN-DRAIN LOGIC OUTPUT PIN CHARACTERISTICS (ACGOOD)						
V _{O(LO)}	Output low saturation voltage	Sink Current = 4 mA			0.5	V
	$\overline{\text{ACGOOD}}$ falling delay	V _{ACDET} rising	6.4	8	9.6	ms
	$\overline{\text{ACGOOD}}$ rising delay	V _{ACDET} falling		10		μs
INPUT OVERVOLTAGE COMPARATOR (ACOV)						
V _{ACOV}	AC Overvoltage rising threshold on ACDET (See ACDET in Terminal Functions)		3.007	3.1	3.193	V
V _{ACOV_HYS}	AC Overvoltage rising deglitch			1.3		ms
	AC Overvoltage falling deglitch			1.3		
PVCC / BAT COMPARATOR						
V _{PVCC-BAT_FALL}	PVCC to BAT falling threshold	V _{PVCC} – V _{BAT} falling to disable Charger	140	185	240	mV
V _{PVCC-BAT_HYS}	PVCC to BAT hysteresis			50		mV
	PVCC to BAT Rising Deglitch	V _{PVCC} – V _{BAT} > V _{PVCC-BAT_RISE}	7	9	11	ms
	PVCC to BAT Falling Deglitch	V _{PVCC} – V _{BAT} < V _{PVCC-BAT_FALL}		10		μs
INPUT UNDERVOLTAGE LOCK-OUT COMPARATOR (UVLO)						
UVLO	AC Undervoltage rising threshold	Measure on PVCC	3.5	4	4.5	V
	AC Undervoltage hysteresis, falling			260		mV
BAT OVERVOLTAGE COMPARATOR						
V _O	Overvoltage rising threshold ⁽¹⁾	As percentage of V _{BAT_REG}		104%		
	Overvoltage falling threshold ⁽¹⁾			102%		
CHARGE OVERCURRENT COMPARATOR						
V _{OC}	Charge overcurrent falling threshold	As percentage of I _{REG_CHG}		145%		
	Minimum Current Limit (SRP-SRN)			50		mV
THERMAL SHUTDOWN COMPARATOR						
T _{SHUT}	Thermal shutdown rising temperature	Temperature Increasing		155		°C
T _{SHUT_HYS}	Thermal shutdown hysteresis, falling			20		
PWM HIGH SIDE DRIVER (HIDRV)						
R _{DS(on)}	High side driver turn-on resistance	V _{BTST} – V _{PH} = 5.5 V, tested at 100 mA		3	6	Ω
	High side driver turn-off resistance	V _{BTST} – V _{PH} = 5.5 V, tested at 100 mA		0.7	1.4	
V _{BTST_REFRESH}	Bootstrap refresh comparator threshold voltage	V _{BTST} – V _{PH} when low side refresh pulse is requested	4			V

(1) Specified by design.

ELECTRICAL CHARACTERISTICS (continued)

7 V ≤ V_{PVCC} ≤ 24 V, 0°C < T_J < +125°C, typical values are at T_A = 25°C, with respect to AGND (unless otherwise noted)

PARAMETER		TEST CONDITIONS	MIN	TYP	MAX	UNIT
PWM LOW SIDE DRIVER (LODRV)						
R _{DS(on)}	Low side driver turn-on resistance	REGN = 6 V, tested at 100 mA		3	6	Ω
	Low side driver turn-off resistance	REGN = 6 V, tested at 100 mA		0.6	1.2	
PWM DRIVERS TIMING						
	Driver Dead Time — Dead time when switching between LODRV and HIDRV. No load at LODRV and HIDRV		30			ns
PWM OSCILLATOR						
F _{SW}	PWM switching frequency		480	600	720	kHz
V _{RAMP_HEIGHT}	PWM ramp height	As percentage of PVCC		6.6		%PVCC
QUIESCENT CURRENT						
I _{OFF_STATE}	Total off-state battery current from SRP, SRN, BAT, VCC, BTST, PH, etc.	V _{BAT} = 16.8 V, V _{ACDET} < 0.6 V, V _{PVCC} > 5 V, T _J = 85°C		7	10	μA
		V _{BAT} = 16.8 V, V _{ACDET} < 0.6 V, V _{PVCC} > 5 V, T _J = 125°C		7	11	
I _{AC}	Adapter quiescent current	V _{PVCC} = 20 V, charge disabled		2.8	4	mA
INTERNAL SOFT START (8 steps to regulation current)						
	Soft start steps			8		step
	Soft start step time			1.7		ms
CHARGER SECTION POWER-UP SEQUENCING						
	Charge-enable delay after power-up	Delay from when adapter is detected to when the charger is allowed to turn on	518	700	908	ms
ISYNSET AMPLIFIER AND COMPARATOR (SYNCHRONOUS TO NON-SYNCHRONOUS TRANSITION)						
	I _{SYN} Accuracy	V _(SRP-SRN) = 5 mV	-20%		20%	
V _{ISYNSET}	ISYNSET pin voltage			1		V
	ISYNSET rising deglitch			20		μs
	ISYNSET falling deglitch			640		μs
LOGIC IO PIN CHARACTERISTICS (CHGEN)						
V _{IN(LO)}	Input low threshold voltage				0.8	V
V _{IN(HI)}	Input high threshold voltage		2.1			
I _{BIAS}	Input bias current	V _{CHGEN} = 0 to V _{REGN}			1	μA
LOGIC INPUT PIN CHARACTERISTICS (CELLS)						
V _{IN(LO)}	Input low threshold voltage, 3 cells	CELLS voltage falling edge			0.5	V
V _{IN(MID)}	Input mid threshold voltage, 2 cells	CELLS voltage rising for MIN, CELLS voltage falling for MAX	0.8		1.8	
V _{IN(HI)}	Input high threshold voltage, 4 cells	CELLS voltage rising	2.5			
I _{BIAS_FLOAT}	Input bias float current for 2-cell selection	V = 0 to V _{REGN}	-1		1	μA
OPEN-DRAIN LOGIC OUTPUT PIN CHARACTERISTICS (DPMDET)						
V _{O(LO)}	Output low saturation voltage	Sink Current = 5 mA			0.5	V
	Delay, rising/falling			10		ms

TYPICAL CHARACTERISTICS

Table of Graphs⁽¹⁾

Y	X	Figure
VREF Load and Line Regulation	vs Load Current	Figure 4
REGN Load and Line Regulation	vs Load Current	Figure 5
BAT Voltage	vs VADJ/VREF Ratio	Figure 6
Charge Current	vs SRSET/VREF Ratio	Figure 7
Input Current	vs ACSET/VREF Ratio	Figure 8
BAT Voltage Regulation Accuracy	vs Charge Current	Figure 9
BAT Voltage Regulation Accuracy		Figure 10
Charge Current Regulation Accuracy		Figure 11
Input Current Regulation (DPM) Accuracy		Figure 12
V _{IADAPT} Input Current Sense Amplifier Accuracy		Figure 13
Input Regulation Current (DPM), and Charge Current	vs System Current	Figure 14
Transient System Load (DPM) Response		Figure 15
Charge Current Regulation	vs BAT Voltage	Figure 16
Efficiency	vs Battery Charge Current	Figure 17
Battery Removal (from Constant Current Mode)		Figure 18
REF and REGN Startup		Figure 19
Charger on Adapter Removal		Figure 20
Charge Enable / Disable and Current Soft-Start		Figure 21
Nonsynchronous to Synchronous Transition		Figure 22
Synchronous to Nonsynchronous Transition		Figure 23
Near 100% Duty Cycle Bootstrap Recharge Pulse		Figure 24
Battery Shorted Charger Response, Over Current Protection (OCP) and Charge Current Regulation		Figure 25
Continuous Conduction Mode (CCM) Switching Waveforms		Figure 26
Discontinuous Conduction Mode (DCM) Switching Waveforms		Figure 28
DPMD _{ET} Response with Transient System Load		Figure 27

(1) Test results based on Figure 3 application schematic. V_{IN} = 20 V, V_{BAT} = 3-cell Li-Ion, I_{CHG} = 3 A, I_{ADAPTER_LIMIT} = 4 A, T_A = 25°C, unless otherwise specified.

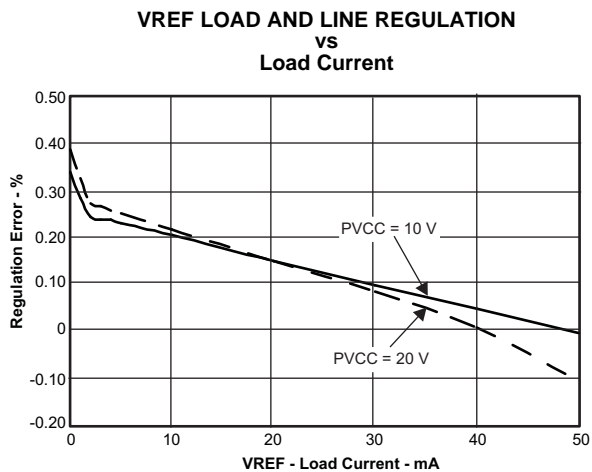

Figure 4.

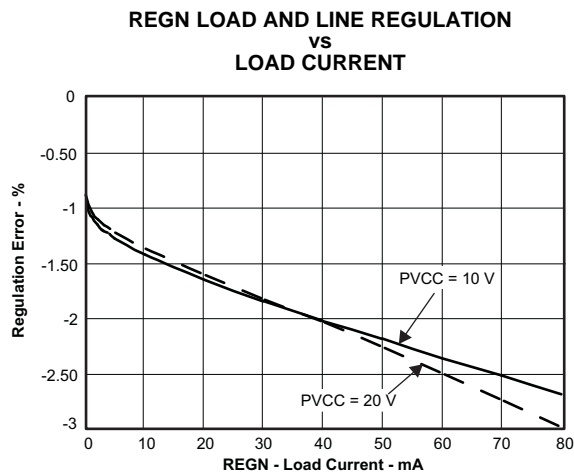

Figure 5.

**BAT VOLTAGE
VS
VADJ/REF RATIO**

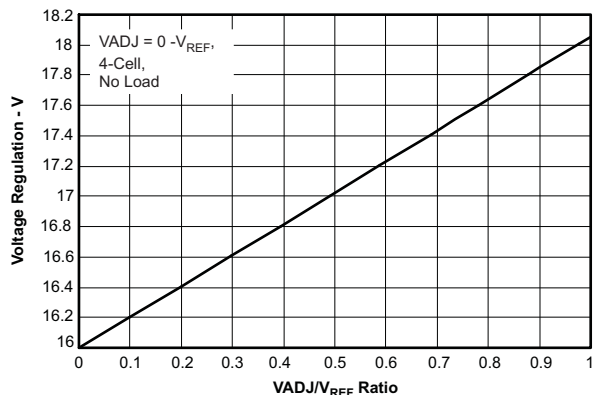

Figure 6.

**CHARGE CURRENT
VS
SRSET/REF RATIO**

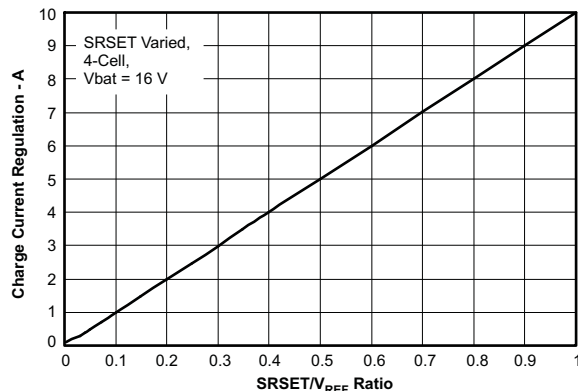

Figure 7.

**INPUT CURRENT
VS
ACSET/REF RATIO**

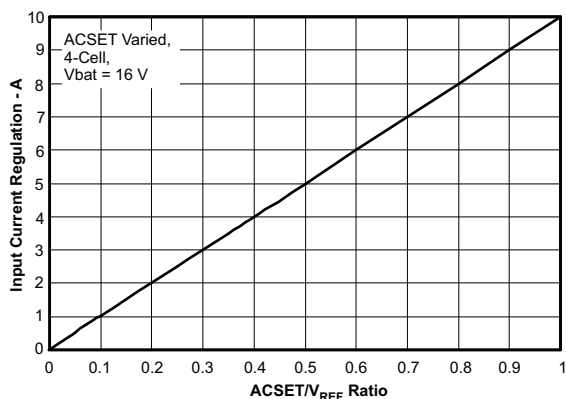

Figure 8.

**BAT VOLTAGE REGULATION ACCURACY
VS
CHARGE CURRENT**

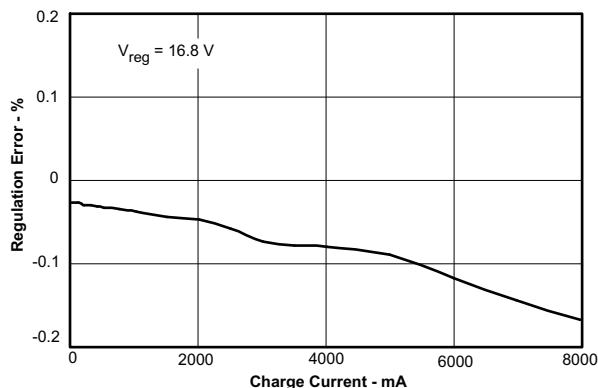

Figure 9.

BAT VOLTAGE REGULATION ACCURACY

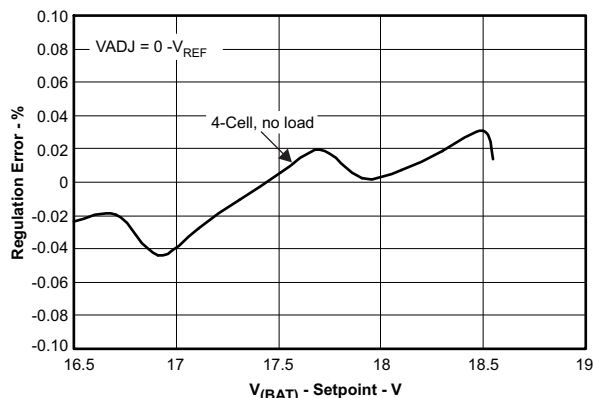

Figure 10.

CHARGE CURRENT REGULATION ACCURACY

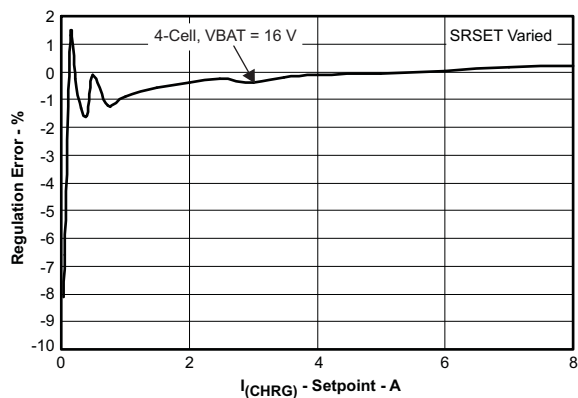

Figure 11.

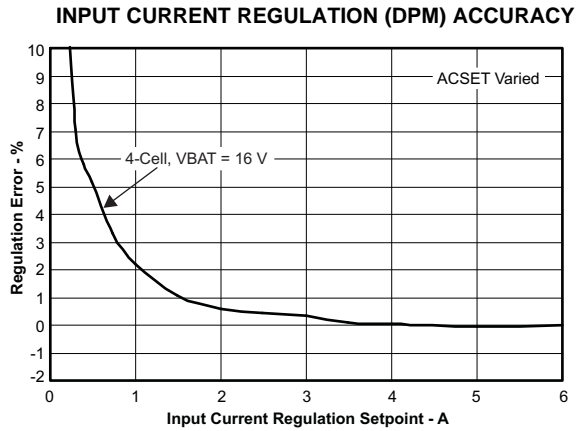

Figure 12.

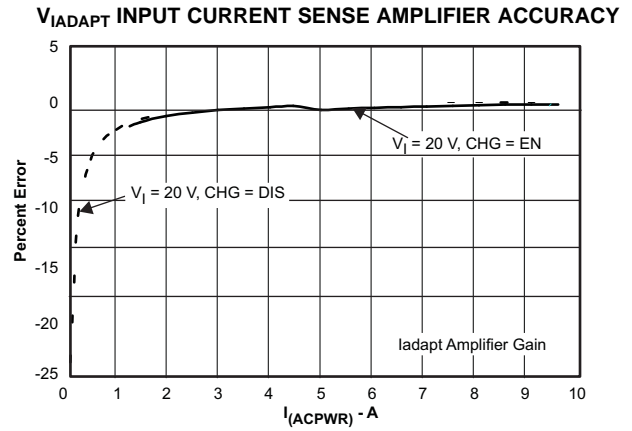

Figure 13.

INPUT REGULATION CURRENT (DPM), AND CHARGE CURRENT VS SYSTEM CURRENT

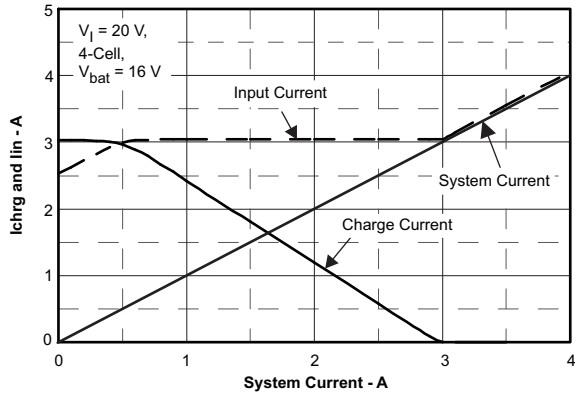

Figure 14.

TRANSIENT SYSTEM LOAD (DPM) RESPONSE

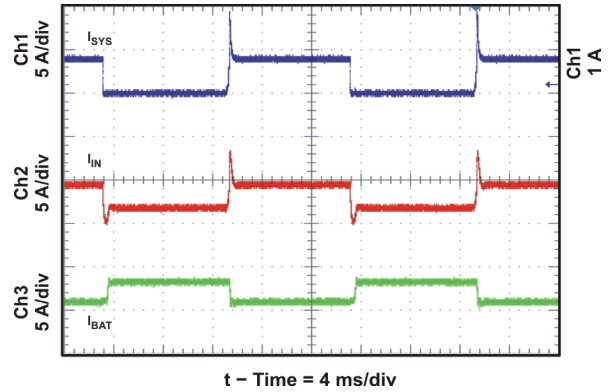

Figure 15.

CHARGE CURRENT REGULATION VS BAT VOLTAGE

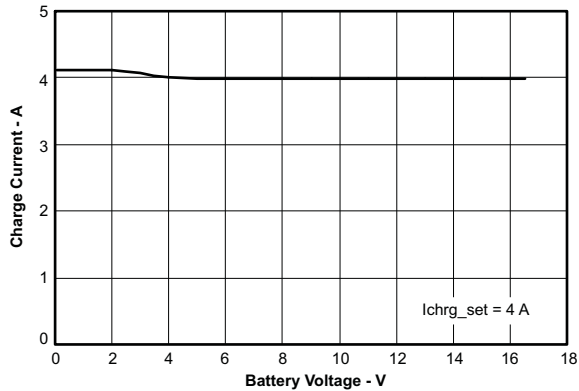

Figure 16.

EFFICIENCY VS BATTERY CHARGE CURRENT

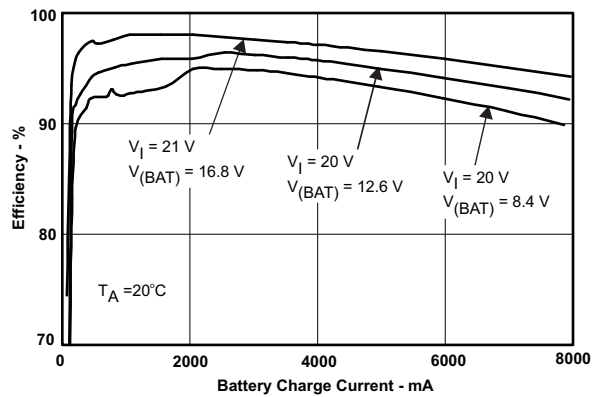
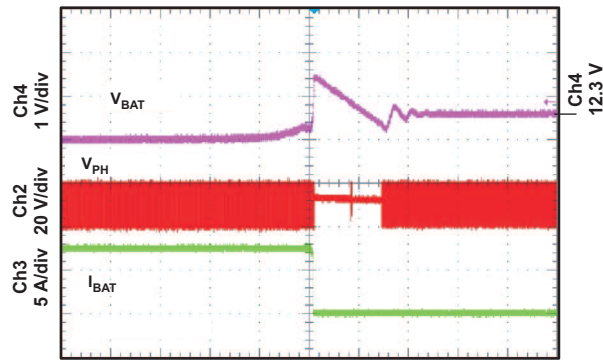

Figure 17.

BATTERY REMOVAL



t - Time = 5 ms/div

Figure 18.

REF AND REGN STARTUP

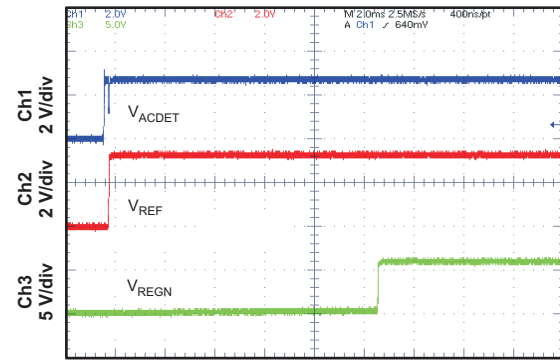

t - Time = 2 ms/div

Figure 19.

CHARGER ON ADAPTER REMOVAL

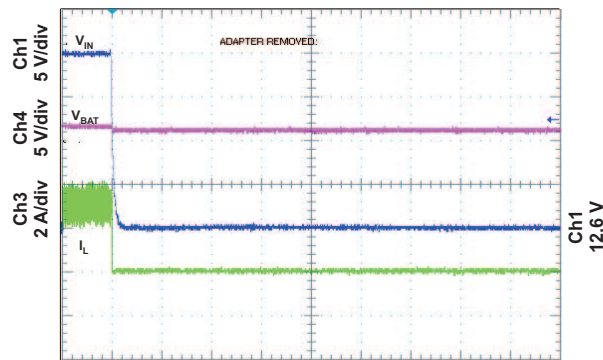

t - Time = 200 μ s/div

Figure 20.

CHARGE ENABLE / DISABLE AND CURRENT SOFT-START

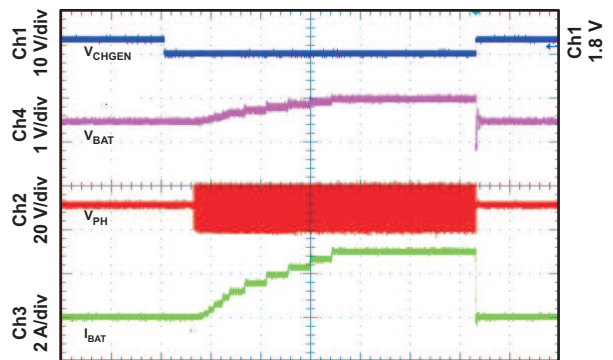

t - Time = 4 ms/div

Figure 21.

NONSYNCHRONOUS TO SYNCHRONOUS TRANSITION

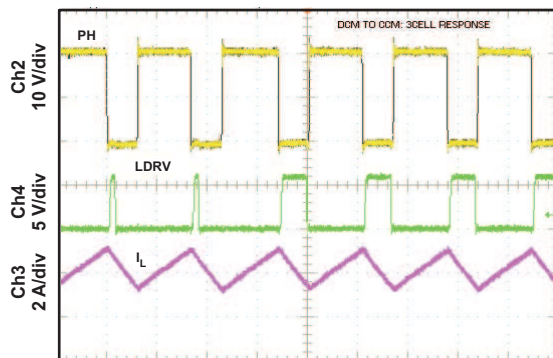

t - Time = 1 μ s/div

Figure 22.

SYNCHRONOUS TO NONSYNCHRONOUS TRANSITION

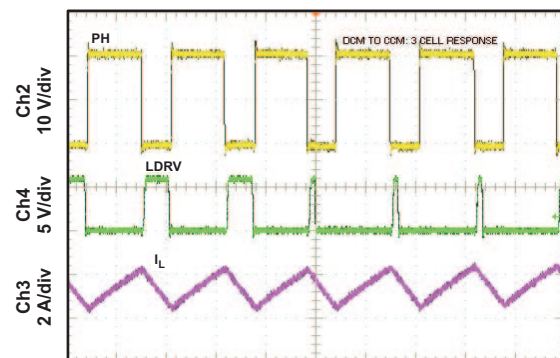

t - Time = 1 μ s/div

Figure 23.

NEAR 100% DUTY CYCLE BOOTSTRAP RECHARGE PULSE

Figure 24.

BATTERY SHORTED CHARGER RESPONSE, OVERCURRENT PROTECTION (OCP) AND CHARGE CURRENT REGULATION

Figure 25.

CONTINUOUS CONDUCTION MODE (CCM) SWITCHING WAVEFORMS

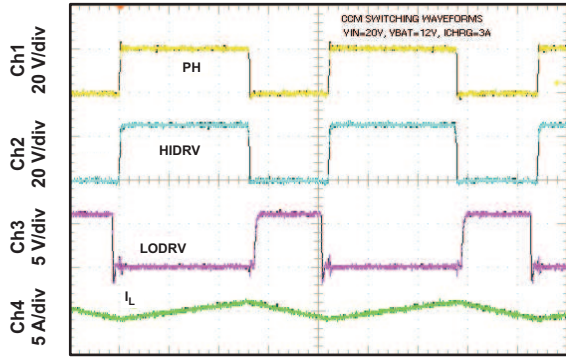

t - Time = 400 ns/div

Figure 26.

DISCONTINUOUS CONDUCTION MODE (DCM) SWITCHING WAVEFORMS

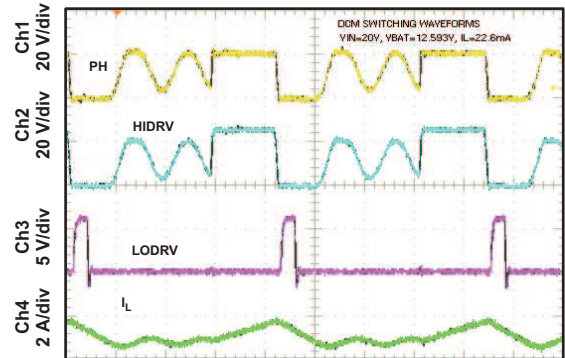

t - Time = 400 ns/div

Figure 27.

DPMDET RESPONSE WITH TRANSIENT SYSTEM LOAD

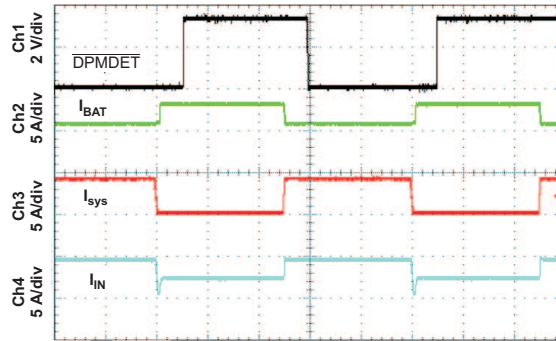

t - Time = 20 ms/div

Figure 28.

DETAILED DESCRIPTION

BATTERY VOLTAGE REGULATION

The bq24705 uses a high-accuracy voltage regulator for charging voltage. The internal default battery voltage setting $V_{BATT} = 4.2 \text{ V} \times \text{cell count}$. The regulation voltage is ratio-metric with respect to VREF. The ratio of VADJ and VREF provides extra 12.5% adjust range on V_{BATT} regulation voltage. By limiting the adjust range to 12.5% of the regulation voltage, the external resistor mismatch error is reduced from $\pm 1\%$ to $\pm 0.1\%$. Therefore, an overall voltage accuracy as good as 0.5% is maintained, while using 1% mis-match resistors. Ratio-metric conversion also allows compatibility with D/As or microcontrollers (μC). The battery voltage is programmed through VADJ and VREF using [Equation 1](#).

$$V_{BAT} = \text{cell count} \times \left[4\text{V} + \left(0.512 \times \frac{V_{VADJ}}{V_{REF}} \right) \right] \quad (1)$$

VADJ is set between 0 and VREF. V_{BATT} defaults to $4.2 \text{ V} \times \text{cell count}$ when VADJ is connected to REGN.

CELLS pin is the logic input for selecting cell count. Connect CELLS to charge 2, 3, or 4 Li+ cells. When charging other cell chemistries, use CELLS to select an output voltage range for the charger.

CELLS	CELL COUNT
Float	2
AGND	3
VREF	4

The per-cell battery termination voltage is function of the battery chemistry. Consult the battery manufacturer to determine this voltage.

The BAT pin is used to sense the battery voltage for voltage regulation and should be connected as close to the battery as possible, or directly on the output capacitor. A $0.1\text{-}\mu\text{F}$ ceramic capacitor from BAT to AGND is recommended to be as close to the BAT pin as possible to decouple high frequency noise.

BATTERY CURRENT REGULATION

The SRSET input sets the maximum charging current. Battery current is sensed by resistor R_{SR} connected between SRP and SRN. The full-scale differential voltage between SRP and SRN is 100 mV. Thus, for a 0.010Ω sense resistor, the maximum charging current is 10 A. SRSET is ratio-metric with respect to VREF using [Equation 2](#):

$$I_{CHARGE} = \frac{V_{SRSET}}{V_{REF}} \times \frac{0.10}{R_{SR}} \quad (2)$$

The input voltage range of SRSET is between 0 and VREF, up to 3.3 V.

The SRP and SRN pins are used to sense across R_{SR} with default value of $10 \text{ m}\Omega$. However, resistors of other values can also be used. A larger the sense resistor, gives a larger sense voltage, and a higher regulation accuracy, but at the expense of higher conduction loss.

INPUT ADAPTER CURRENT REGULATION

The total input from an AC adapter or other DC sources is a function of the system supply current and the battery charging current. System current normally fluctuates as portions of the systems are powered up or down. Without Dynamic Power Management (DPM), the source must be able to supply the maximum system current and the maximum charger input current simultaneously. By using DPM, the input current regulator reduces the charging current when the input current exceeds the input current limit set by ACSET. The current capability of the AC adapter can be lowered, which may reduce the system cost.

Similar to setting battery regulation current, adapter current is sensed by resistor R_{AC} connected between ACP and ACN. The maximum value is set by ACSET, which is a ratio-metric with respect to VREF, using [Equation 3](#).

bq24705

SLUS779B–DECEMBER 2007–REVISED MARCH 2009

www.ti.com

$$I_{\text{ADAPTER}} = \frac{V_{\text{ACSET}}}{V_{\text{REF}}} \times \frac{0.10}{R_{\text{AC}}} \quad (3)$$

The input voltage range of ACSET is between 0 and VREF, up to 3.3 V.

The ACP and ACN pins are used to sense R_{AC} with default value of 10mΩ. However, resistors of other values can also be used. A larger the sense resistor, gives a larger sense voltage, and a higher regulation accuracy; but, at the expense of higher conduction loss.

ADAPTER DETECT AND POWER UP

An external resistor voltage divider attenuates the adapter voltage before it goes to ACDET. The adapter detect threshold should typically be programmed to a value greater than the maximum battery voltage, and lower than the minimum allowed adapter voltage. The ACDET divider should be placed before the ACFET in order to sense the true adapter input voltage whether the ACFET is on or off.

If PVCC is below 4 V, the device is disabled.

If ACDET is below 0.6 V but PVCC is above 4 V, part of the bias is enabled, including a crude bandgap reference. IADAPT is disabled and pulled down to GND. The total quiescent current is less than 10 μA.

Once ACDET rises above 0.6 V and PVCC is above 4 V, all the bias circuits are enabled. VREF goes to 3.3 V and REGN output goes to 6 V. IADAPT becomes valid to proportionally reflect the adapter current.

When ACDET rises and passes 2.4 V, a valid AC adapter is present. Then the following occurs:

- $\overline{\text{ACGOOD}}$ becomes high through external pull-up resistor to the host digital voltage rail;
- Charger turns on if all the conditions are satisfied (see *Enable and Disable Charging*).

ENABLE AND DISABLE CHARGING

The following conditions must be valid before a charge is enabled:

- $\overline{\text{CHGEN}}$ is LOW;
- PVCC > UVLO;
- Adapter is detected;
- Adapter is higher than PVCC-BAT threshold;
- Adapter is not over voltage;
- 700 ms delay is complete after adapter detected;
- REGNGOOD and VREFGOOD are valid;
- Thermal Shut (TSHUT) is not valid;

One of the following conditions will stop on-going charging:

- $\overline{\text{CHGEN}}$ is HIGH;
- PVCC < UVLO;
- Adapter is removed;
- Adapter is less than PVCC-BAT threshold;
- Adapter is over voltage;
- Adapter is over current;
- TSHUT IC temperature threshold is reached (155°C on rising-edge with 20°C hysteresis).

AUTOMATIC INTERNAL SOFT-START CHARGER CURRENT

The charger automatically soft-starts the charger regulation current every time the charger is enabled to ensure there is no overshoot or stress on the output capacitors or the power converter. The soft-start consists of stepping-up the charge regulation current into 8 evenly divided steps up to the programmed charge current. Each step lasts around 1.7ms, for a typical rise time of 13.6ms. No external components are needed for this function.

CONVERTER OPERATION

The synchronous buck PWM converter uses a fixed frequency (600 kHz) voltage mode with feed-forward control scheme. A type III compensation network allows using ceramic capacitors at the output of the converter. The compensation input stage is connected internally between the feedback output (FBO) and the error amplifier input (EAI). The feedback compensation stage is connected between the error amplifier input (EAI) and error amplifier output (EAO). The LC output filter is selected to give a resonant frequency of 8–12.5 kHz nominal.

$$f_o = \frac{1}{2\pi\sqrt{L_o C_o}}$$

Where resonant frequency, f_o , is given by: where (from [Figure 2](#) schematic)

- $C_o = C11 + C12$
- $L_o = L1$

An internal saw-tooth ramp is compared to the internal EAO error control signal to vary the duty-cycle of the converter. The ramp height is one-fifteenth of the input adapter voltage making it always directly proportional to the input adapter voltage. This cancels out any loop gain variation due to a change in input voltage, and simplifies the loop compensation. The ramp is offset by 200 mV in order to allow zero percent duty-cycle, when the EAO signal is below the ramp. The EAO signal is also allowed to exceed the saw-tooth ramp signal in order to get a 100% duty-cycle PWM request. Internal gate drive logic allows achieving 99.98% duty-cycle while ensuring the N-channel upper device always has enough voltage to stay fully on. If the BTST pin to PH pin voltage falls below 4 V for more than 3 cycles, then the high-side n-channel power MOSFET is turned off and the low-side n-channel power MOSFET is turned on to pull the PH node down and recharge the BTST capacitor. Then the high-side driver returns to 100% duty-cycle operation until the (BTST-PH) voltage is detected to fall low again due to leakage current discharging the BTST capacitor below the 4 V, and the reset pulse is reissued.

The 600 kHz fixed frequency oscillator keeps tight control of the switching frequency under all conditions of input voltage, battery voltage, charge current, and temperature, simplifying output filter design and keeping it out of the audible noise region. The charge current sense resistor R_{SR} should be placed with at least half or more of the total output capacitance placed before the sense resistor contacting both sense resistor and the output inductor; and the other half or remaining capacitance placed after the sense resistor. The output capacitance should be divided and placed onto both sides of the charge current sense resistor. A ratio of 50:50 percent gives the best performance; but the node in which the output inductor and sense resistor connect should have a minimum of 50% of the total capacitance. This capacitance provides sufficient filtering to remove the switching noise and give better current sense accuracy. The type III compensation provides phase boost near the cross-over frequency, giving sufficient phase margin.

SYNCHRONOUS AND NON-SYNCHRONOUS OPERATION

The charger operates in non-synchronous mode when the sensed charge current is below the ISYNSET value. Otherwise, the charger operates in synchronous mode.

During synchronous mode, the low-side n-channel power MOSFET is on, when the high-side n-channel power MOSFET is off. The internal gate drive logic ensures there is break-before-make switching to prevent shoot-through currents. During the 30ns dead time where both FETs are off, the back-diode of the low-side power MOSFET conducts the inductor current. Having the low-side FET turn-on keeps the power dissipation low, and allows safely charging at high currents. During synchronous mode the inductor current is always flowing and operates in Continuous Conduction Mode (CCM), creating a fixed two-pole system.

During non-synchronous operation, after the high-side n-channel power MOSFET turns off, and after the break-before-make dead-time, the low-side n-channel power MOSFET will turn-on for around 80ns, then the low-side power MOSFET will turn-off and stay off until the beginning of the next cycle, where the high-side power MOSFET is turned on again. The 80ns low-side MOSFET on-time is required to ensure the bootstrap capacitor is always recharged and able to keep the high-side power MOSFET on during the next cycle. This is important for battery chargers, where unlike regular dc-dc converters, there is a battery load that maintains a voltage and can both source and sink current. The 80-ns low-side pulse pulls the PH node (connection between high and low-side MOSFET) down, allowing the bootstrap capacitor to recharge up to the REGN LDO value. After the 80 ns, the low-side MOSFET is kept off to prevent negative inductor current from occurring. The inductor current is blocked by the off low-side MOSFET, and the inductor current will become discontinuous. This mode is called Discontinuous Conduction Mode (DCM).

bq24705

SLUS779B–DECEMBER 2007–REVISED MARCH 2009

www.ti.com

During the DCM mode the loop response automatically changes and has a single pole system at which the pole is proportional to the load current, because the converter does not sink current, and only the load provides a current sink. This means at low currents the loop response is slower, as there is less sinking current available to discharge the output voltage. At low currents during non-synchronous operation, there may be a small amount of negative inductor current during the 80 ns recharge pulse. The charge should be low enough to be absorbed by the input capacitance.

When $BTST - PH < 4$ V, the 80-ns recharge pulse occurs on LODRV, the high-side MOSFET does not turn on. The low-side MOSFET does not turn on (only 80-ns recharge pulse).

ISYNSET CONTROL (SYN AND NON-SYN MODE SETTING)

The ISYNSET pin is used to program the charge current threshold at which the charger changes from synchronous operation into non-synchronous operation. The low side driver turns on for only 80 ns to charge the boost capacitor. This is important to prevent negative inductor current, which may cause a boost effect in which the input voltage increases as power is transferred from the battery to the input capacitors. This boost effect can lead to an overvoltage on the PVCC node, and potentially cause some damage to the system. This programmable value allows setting the current threshold for any inductor current ripple, and avoiding negative inductor current. The minimum synchronous threshold should be set from 1/2 of the inductor current ripple to the full ripple current, where the inductor current ripple is given by:

$$\frac{I_{RIPPLE_MAX}}{2} \leq I_{SYN} \leq I_{RIPPLE_MAX}$$

and

$$I_{RIPPLE} = \frac{(V_{IN} - V_{BAT}) \times \frac{V_{BAT}}{V_{IN}} \times \frac{1}{f_S}}{L} = \frac{V_{IN} \times (1-D) \times D \times \frac{1}{f_S}}{L} \quad (4)$$

where:

- V_{IN} = adapter voltage
- V_{BAT} = BAT voltage
- f_S = switching frequency
- L = output inductor
- D = duty-cycle

I_{RIPPLE_MAX} happens when the duty-cycle, D is mostly near to 0.5 at given V_{in} , f_s , and L.

The ISYNSET comparator, or charge undercurrent comparator, compares the voltage between SRP-SRN, and the threshold set by an external resistor $R_{ISYNSET}$, which can be calculated by:

$$R_{ISYNSET} = \frac{250 \text{ V}}{I_{SYN} \times R_{SENSE}} \Omega \quad (5)$$

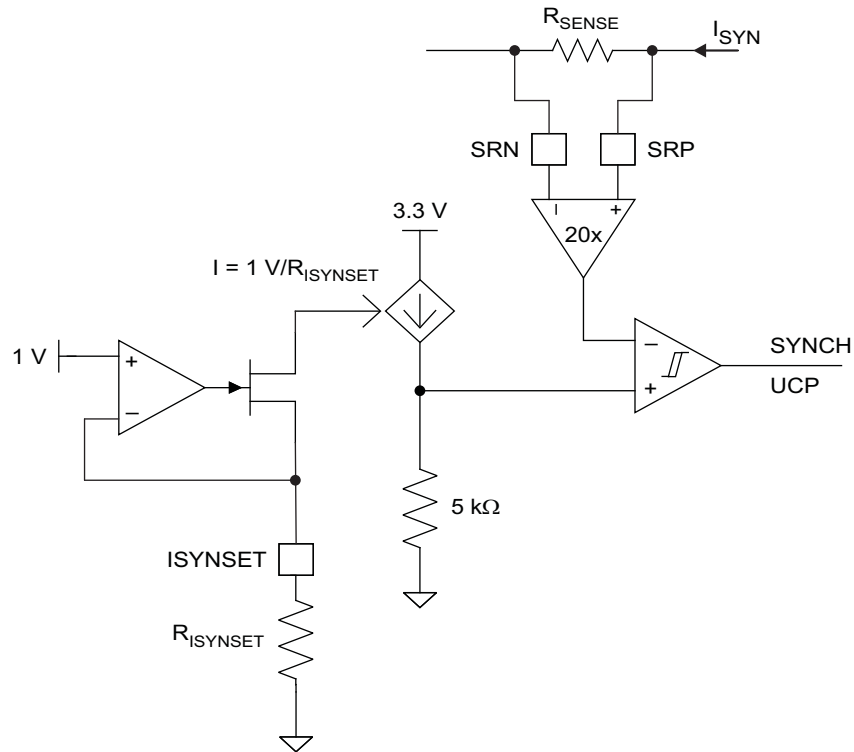

Figure 29. ISYNSET Comparator Block

HIGH ACCURACY IADAPT USING CURRENT SENSE AMPLIFIER (CSA)

An industry standard, high accuracy current sense amplifier (CSA) is used to monitor the input current by the host or some discrete logic through the analog voltage output of the IADAPT pin. The CSA amplifies the input sensed voltage of ACP – ACN by 20x through the IADAPT pin. The IADAPT output is a voltage source 20 times the input differential voltage. Once PVCC is above 5 V and ACDET is above 0.6V, IADAPT no longer stays at ground, but becomes active. If the user wants to lower the voltage, they could use a resistor divider from IOUT to AGND, and still achieve accuracy over temperature as the resistors can be matched their thermal coefficients.

A 100-pF capacitor connected on the output is recommended for decoupling high-frequency noise. An additional RC filter is optional, after the 100-pF capacitor, if additional filtering is desired. Note that adding filtering also adds additional response delay.

INPUT OVERVOLTAGE PROTECTION (ACOV)

ACOV provides protection to prevent system damage due to high input voltage. The controller enters ACOV when ACDET > 3.1 V and charge is disabled. ACOV is not latched—normal operation resumes when the ACDET voltage returns below 3.1 V. ACOV threshold is 130% of the adapter-detect threshold.

INPUT UNDERVOLTAGE LOCK OUT (UVLO)

The system must have a minimum 4 V PVCC voltage to allow proper operation. This PVCC voltage could come from either input adapter or battery, using a diode-OR input. When the PVCC voltage is below 4 V the bias circuits REGN and VREF stay inactive, even with ACDET above 0.6 V.

bq24705

SLUS779B–DECEMBER 2007–REVISED MARCH 2009

www.ti.com**BATTERY OVERVOLTAGE PROTECTION**

The converter stops switching when BAT voltage goes above 104% of the regulation voltage. The converter will not allow the high-side FET to turn on until the BAT voltage goes below 102% of the regulation voltage. This allows one-cycle response to an overvoltage condition, such as when the load is removed or the battery is disconnected. A 10-mA current sink from BAT to PGND is on only during charge, and allows discharging the stored output-inductor energy into the output capacitors.

CHARGE OVERCURRENT PROTECTION

The charger has a secondary overcurrent protection. It monitors the charge current, and prevents the current from exceeding 145% of regulated charge current. The high-side gate drive turns off when the overcurrent is detected, and automatically resumes when the current falls below the overcurrent threshold.

THERMAL SHUTDOWN PROTECTION

The QFN package has low thermal impedance, which provides good thermal conduction from the silicon to the ambient, to keep junction temperatures low. As added level of protection, the charger converter turns off and self-protects whenever the junction temperature exceeds the TSHUT threshold of 155°C. The charger stays off until the junction temperature falls below 135°C.

Status Outputs ($\overline{\text{ACGOOD}}$, $\overline{\text{DPMDDET}}$)

Two status outputs are available, and they require external pull up resistors to pull the pins to system digital rail for a high level.

$\overline{\text{ACGOOD}}$ open-drain output goes low if ACDET is above 2.4 V.

$\overline{\text{DPMDDET}}$ open-drain output goes low when the DPM loop is active to reduce the battery charge current (after a 10-ms delay).

Table 2. Component List for Typical System Circuit of Figure 2

PART DESIGNATOR	QTY	DESCRIPTION
Q1, Q2, Q3	3	P-channel MOSFET, -30V,-6A, SO-8, Vishay-Siliconix, Si4435
Q4, Q5	2	N-channel MOSFET, 30V, 12.5A, SO-8, Fairchild, FDS6680A
D1, D2	2	Diode, Dual Schottky, 30V, 200mA, SOT23, Fairchild, BAT54C
R _{AC} , R _{SR}	2	Sense Resistor, 10 mΩ, 1%, 1W, 2010, Vishay-Dale, WSL2010R0100F
L1	1	Inductor, 4.7μH, Vishay-Dale, IHLP5050CE-01
C6, C7, C11, C12	4	Capacitor, Ceramic, 10μF, 25V, 20%, X5R, 1206, Panasonic, ECJ-3YB1E106M
C4, C10	2	Capacitor, Ceramic, 1μF, 25V, 10%, X7R, 2012, TDK, C2012X7R1E105K
C2, C3, C8, C9, C13, C14, C15	7	Capacitor, Ceramic, 0.1μF, 50V, 10%, X7R, 0805, Kemet, C0805C104K5RACTU
C5	1	Capacitor, Ceramic, 100pF, 25V, 10%, X7R, 0805, Kemet, C0805C101K5RACTU
C1	1	Capacitor, Ceramic, 2.2μF, 25V, 10%, X7R, 2012, TDK, C2012X7R1E225K
R3, R4	2	Resistor, Chip, 10 kΩ, 1/16W, 5%, 0402
R1	1	Resistor, Chip, 432 kΩ, 1/16W, 1%, 0402
R2	1	Resistor, Chip, 66.5 kΩ, 1/16W, 1%, 0402
R10	1	Resistor, Chip, 2 Ω, 1W, 1%, 1210
R6	1	Resistor, Chip, 30 kΩ, 1/16W, 1%, 0402

APPLICATION INFORMATION

Input Capacitance Calculation

During the adapter hot plug-in, the ACFET has not been turned on. The AC switch is off and the simplified equivalent circuit of the input is shown in Figure 30.

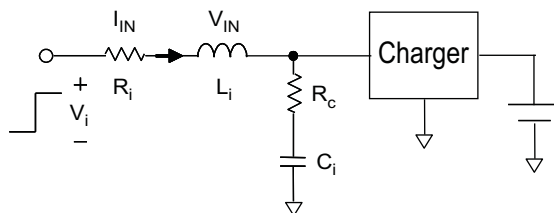

- A. R_i: Equivalent resistance of cable
- B. L_i: Equivalent inductance of cable
- C. R_C ESR of C_i
- D. C_i: Decoupling capacitor

Figure 30. Simplified Equivalent Circuit During Adapter Insertion

The voltage on the input capacitor(s) is given by:

$$V_{IN}(t) = I_{IN}(t) \times R_C + V_{C_i}(t) = V_i - V_i e^{\frac{R_t}{2L_i}t} \left[\frac{R_i - R_C}{\omega L_i} \sin\omega t + \cos\omega t \right]$$

$$V_{C_i}(t) = V_i - V_i e^{\frac{R_t}{2L_i}t} \left[\frac{R_t}{2\omega L_i} \sin\omega t + \cos\omega t \right]$$

$$R_t = R_i + R_C \quad \omega = \sqrt{\frac{1}{L_i C_i} - \left(\frac{R_t}{2L_i}\right)^2} \quad I_{in}(t) = \frac{V_i}{\omega L_i} e^{\frac{R_t}{2L_i}t} \sin\omega t \quad (6)$$

Damping Conditions:

$$R_t = R_i + R_C > 2\sqrt{\frac{L_i}{C_i}} \quad (7)$$

Figure 31(a) demonstrates a high C_i which helps dampen the voltage spike. Figure 31(b) demonstrates the effect of the input stray inductance (L_i) on the input voltage spike. The dashed curve in Figure 31(b) represents the worst case for $C_i = 40 \mu\text{F}$. Figure 31(c) shows how the resistance helps to suppress the input voltage spike.

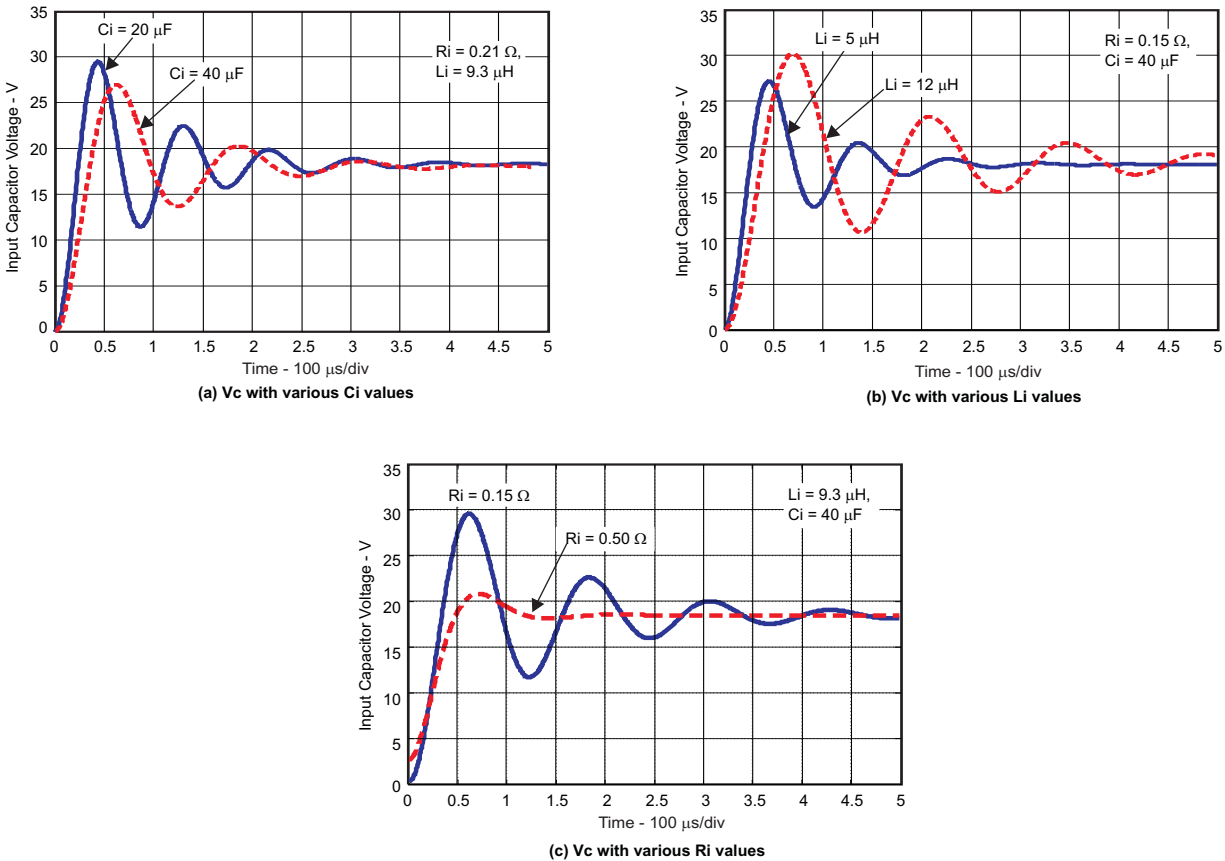

Figure 31. Parametric Study Of The Input Voltage

As shown in Figure 31, minimizing the input stray inductance, increasing the input capacitance, and adding resistance (including using higher ESR capacitors) helps suppress the input voltage spike. However, a user often cannot control input stray inductance, and increasing capacitance can increase costs. therefore, the most efficient and cost-effective approach is to add an external resistor.

Figure 32 depicts the recommended input filter design. The measured input voltage and current waveforms are shown in Figure 33. The input voltage spike has been well damped by adding a 2Ω resistor, while keeping the capacitance low.

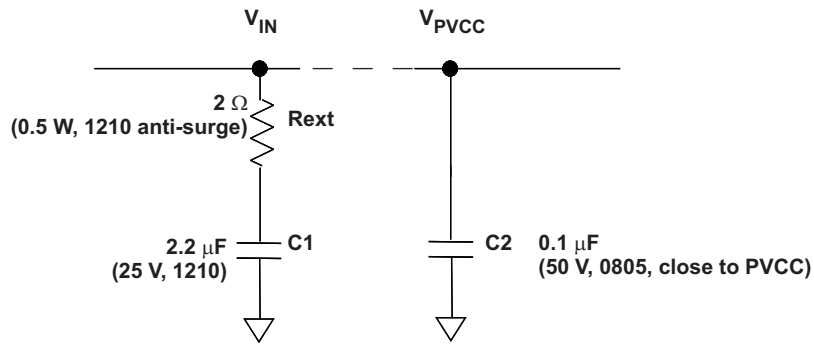

Figure 32. Recommended Input Filter Design

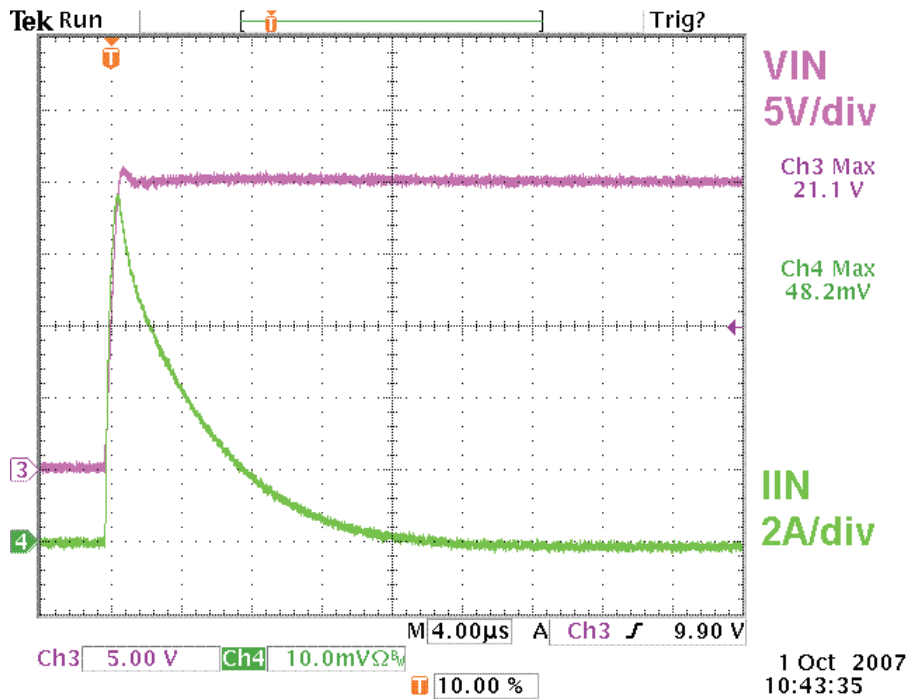
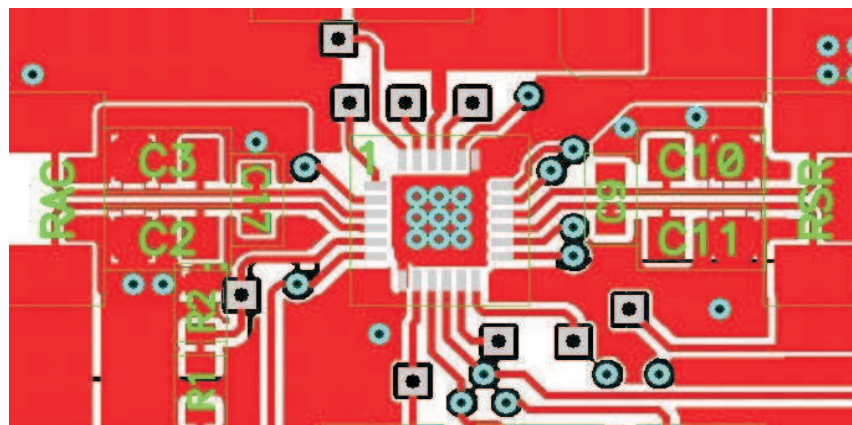

Figure 33. Adapter DC Side Hot Plug-In Test Waveforms

PCB Layout Design Guideline

1. It is critical that the exposed power pad on the backside of the IC package be soldered to the PCB ground. Ensure that there are sufficient thermal vias directly under the IC, connecting to the ground plane on the other layers.
2. The control stage and the power stage should be routed separately. At each layer, the signal ground and the power ground are connected only at the power pad.
3. The AC current-sense resistor must be connected to ACP (pin 4) and ACN (pin 3) with a Kelvin contact. The area of this loop must be minimized. An additional 0.1 μF decoupling capacitor for ACN is required to further reduce the noise. The decoupling capacitors for these pins should be placed as close to the IC as possible.
4. The charge-current sense resistor must be connected to SRP (pin 16), SRN (pin 15) with a Kelvin contact. The area of this loop must be minimized. An additional 0.1 μF decoupling capacitor for SRN is required to further reduce the noise. The decoupling capacitors for these pins should be placed as close to the IC as possible.
5. Decoupling capacitors for PVCC (pin 1), VREF (pin 8), REGN (pin 21) should be placed underneath the IC (on the bottom layer) with the interconnections to the IC as short as possible.
6. Decoupling capacitors for BAT (pin 14), IADAPT (pin 12) must be placed close to the corresponding IC pins with the interconnections to the IC as short as possible.
7. Decoupling capacitor CX for the charger input must be placed close to the Q4 drain and Q5 source.

Figure 34 shows the recommended component placement with trace and via locations. For the QFN information, see the [SCBA017](#) and [SLUA271](#) documents.



(a) Top Layer

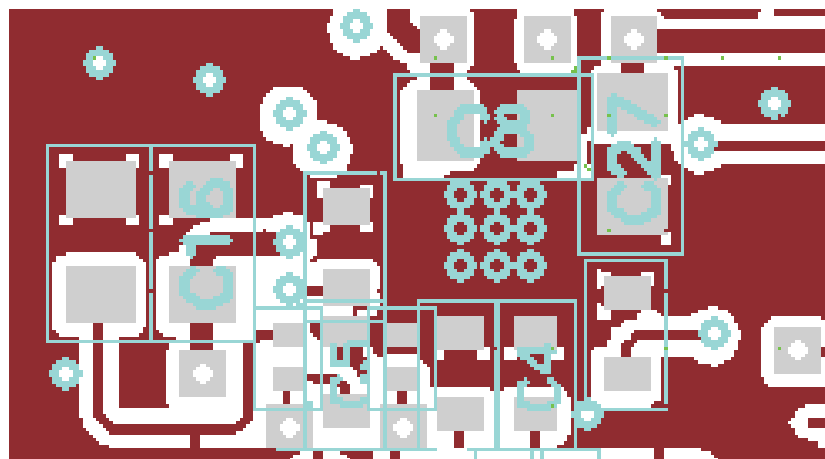

(b) Bottom Layer

Figure 34. Layout Example

PACKAGING INFORMATION

Orderable Device	Status (1)	Package Type	Package Drawing	Pins	Package Qty	Eco Plan (2)	Lead/Ball Finish (6)	MSL Peak Temp (3)	Op Temp (°C)	Device Marking (4/5)	Samples
BQ24705RGER	NRND	VQFN	RGE	24	3000	Green (RoHS & no Sb/Br)	CU NIPDAU	Level-2-260C-1 YEAR	0 to 125	BQ 24705	
BQ24705RGERG4	NRND	VQFN	RGE	24	3000	Green (RoHS & no Sb/Br)	CU NIPDAU	Level-2-260C-1 YEAR	0 to 125	BQ 24705	
BQ24705RGET	NRND	VQFN	RGE	24	250	Green (RoHS & no Sb/Br)	CU NIPDAU	Level-2-260C-1 YEAR	0 to 125	BQ 24705	
HPA00753RGER	NRND	VQFN	RGE	24	3000	Green (RoHS & no Sb/Br)	CU NIPDAU	Level-2-260C-1 YEAR	0 to 125	BQ 24705	

(1) The marketing status values are defined as follows:

ACTIVE: Product device recommended for new designs.

LIFEBUY: TI has announced that the device will be discontinued, and a lifetime-buy period is in effect.

NRND: Not recommended for new designs. Device is in production to support existing customers, but TI does not recommend using this part in a new design.

PREVIEW: Device has been announced but is not in production. Samples may or may not be available.

OBSOLETE: TI has discontinued the production of the device.

(2) Eco Plan - The planned eco-friendly classification: Pb-Free (RoHS), Pb-Free (RoHS Exempt), or Green (RoHS & no Sb/Br) - please check <http://www.ti.com/productcontent> for the latest availability information and additional product content details.

TBD: The Pb-Free/Green conversion plan has not been defined.

Pb-Free (RoHS): TI's terms "Lead-Free" or "Pb-Free" mean semiconductor products that are compatible with the current RoHS requirements for all 6 substances, including the requirement that lead not exceed 0.1% by weight in homogeneous materials. Where designed to be soldered at high temperatures, TI Pb-Free products are suitable for use in specified lead-free processes.

Pb-Free (RoHS Exempt): This component has a RoHS exemption for either 1) lead-based flip-chip solder bumps used between the die and package, or 2) lead-based die adhesive used between the die and leadframe. The component is otherwise considered Pb-Free (RoHS compatible) as defined above.

Green (RoHS & no Sb/Br): TI defines "Green" to mean Pb-Free (RoHS compatible), and free of Bromine (Br) and Antimony (Sb) based flame retardants (Br or Sb do not exceed 0.1% by weight in homogeneous material)

(3) MSL, Peak Temp. - The Moisture Sensitivity Level rating according to the JEDEC industry standard classifications, and peak solder temperature.

(4) There may be additional marking, which relates to the logo, the lot trace code information, or the environmental category on the device.

(5) Multiple Device Markings will be inside parentheses. Only one Device Marking contained in parentheses and separated by a "~" will appear on a device. If a line is indented then it is a continuation of the previous line and the two combined represent the entire Device Marking for that device.

(6) Lead/Ball Finish - Orderable Devices may have multiple material finish options. Finish options are separated by a vertical ruled line. Lead/Ball Finish values may wrap to two lines if the finish value exceeds the maximum column width.

Important Information and Disclaimer: The information provided on this page represents TI's knowledge and belief as of the date that it is provided. TI bases its knowledge and belief on information provided by third parties, and makes no representation or warranty as to the accuracy of such information. Efforts are underway to better integrate information from third parties. TI has taken and continues to take reasonable steps to provide representative and accurate information but may not have conducted destructive testing or chemical analysis on incoming materials and chemicals. TI and TI suppliers consider certain information to be proprietary, and thus CAS numbers and other limited information may not be available for release.

In no event shall TI's liability arising out of such information exceed the total purchase price of the TI part(s) at issue in this document sold by TI to Customer on an annual basis.

TAPE AND REEL INFORMATION

QUADRANT ASSIGNMENTS FOR PIN 1 ORIENTATION IN TAPE

*All dimensions are nominal

Device	Package Type	Package Drawing	Pins	SPQ	Reel Diameter (mm)	Reel Width W1 (mm)	A0 (mm)	B0 (mm)	K0 (mm)	P1 (mm)	W (mm)	Pin1 Quadrant
BQ24705RGER	VQFN	RGE	24	3000	330.0	12.4	4.25	4.25	1.15	8.0	12.0	Q2
BQ24705RGET	VQFN	RGE	24	250	180.0	12.4	4.25	4.25	1.15	8.0	12.0	Q2

TAPE AND REEL BOX DIMENSIONS

*All dimensions are nominal

Device	Package Type	Package Drawing	Pins	SPQ	Length (mm)	Width (mm)	Height (mm)
BQ24705RGER	VQFN	RGE	24	3000	367.0	367.0	35.0
BQ24705RGET	VQFN	RGE	24	250	210.0	185.0	35.0

RGE 24

GENERIC PACKAGE VIEW

VQFN - 1 mm max height

PLASTIC QUAD FLATPACK - NO LEAD

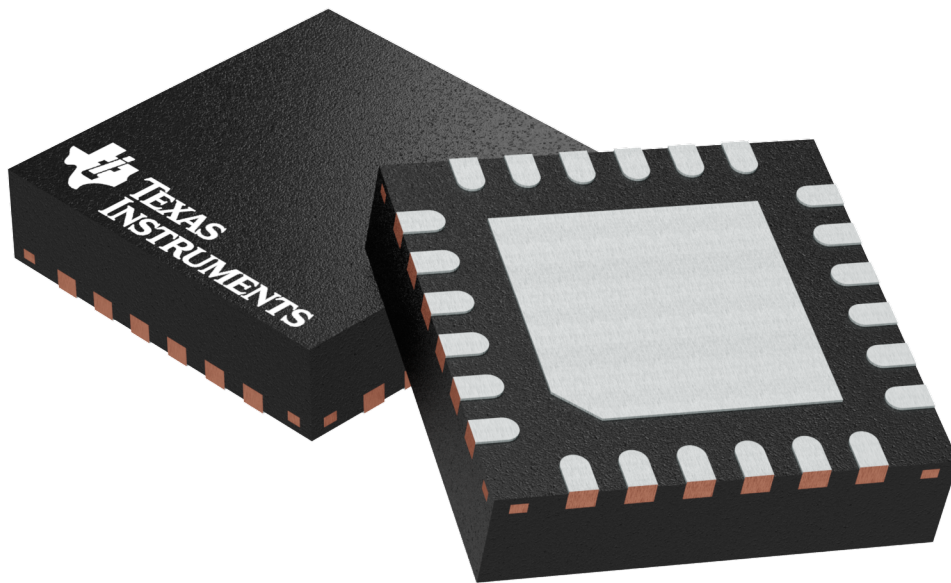

Images above are just a representation of the package family, actual package may vary.
Refer to the product data sheet for package details.

4204104/H

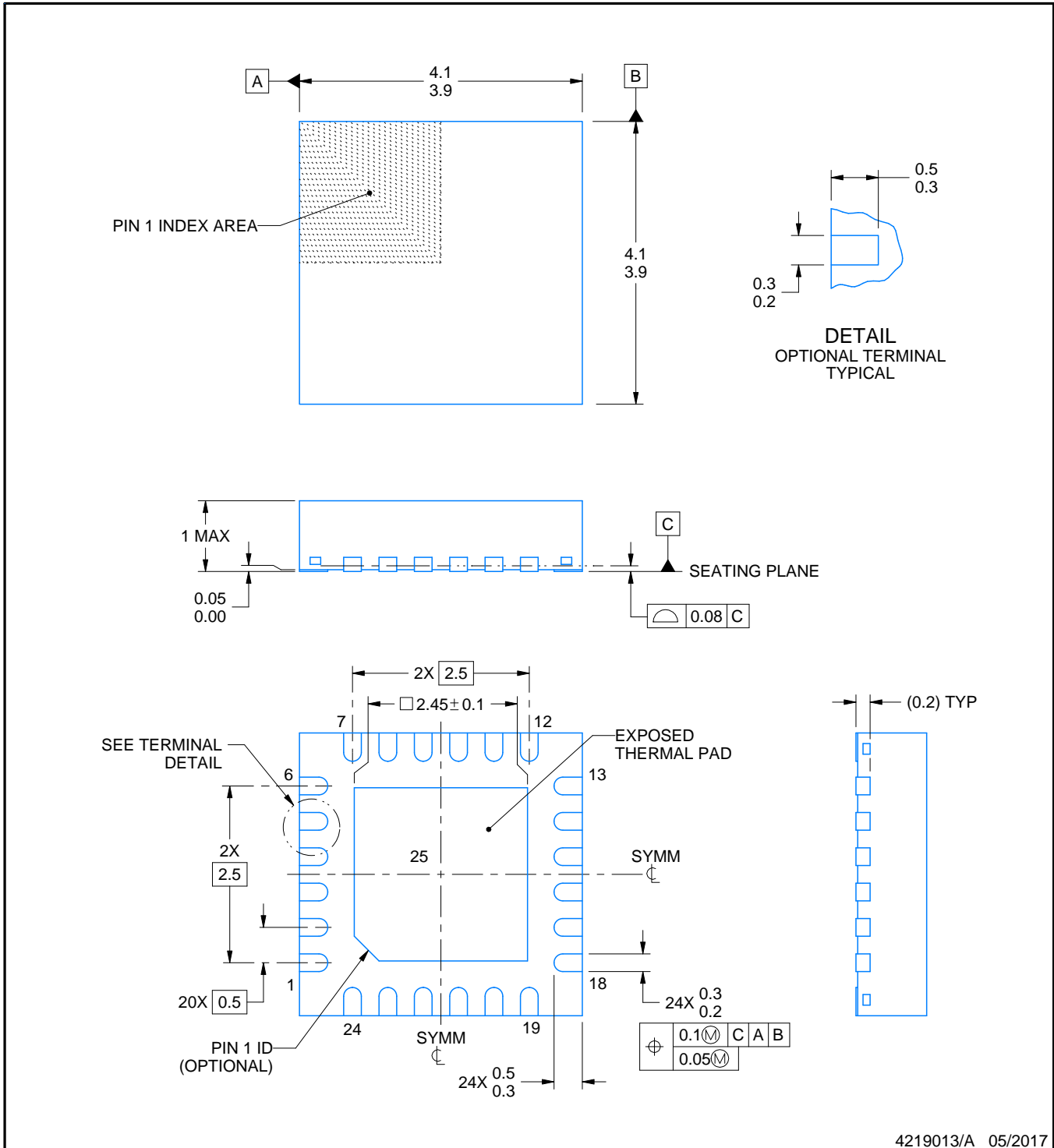
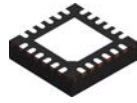

4219013/A 05/2017

NOTES:

1. All linear dimensions are in millimeters. Any dimensions in parenthesis are for reference only. Dimensioning and tolerancing per ASME Y14.5M.
2. This drawing is subject to change without notice.
3. The package thermal pad must be soldered to the printed circuit board for thermal and mechanical performance.

EXAMPLE STENCIL DESIGN

RGE0024B

VQFN - 1 mm max height

PLASTIC QUAD FLATPACK - NO LEAD

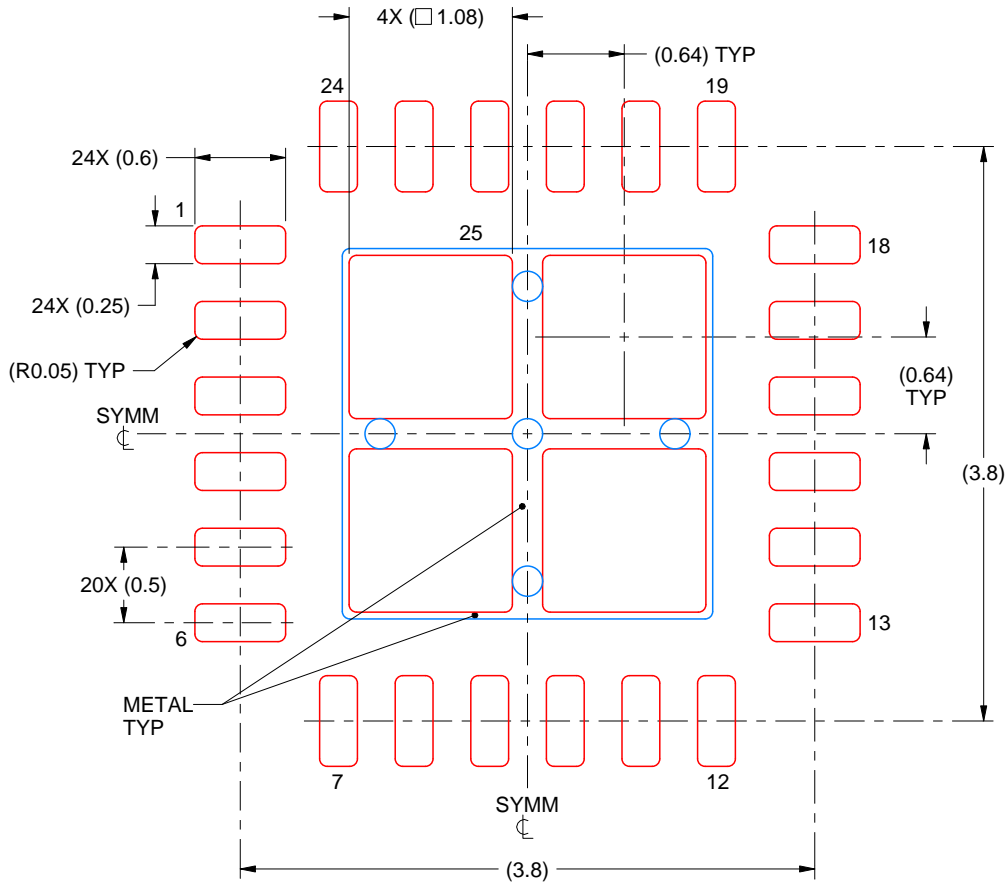

SOLDER PASTE EXAMPLE
 BASED ON 0.125 mm THICK STENCIL

EXPOSED PAD 25
 78% PRINTED SOLDER COVERAGE BY AREA UNDER PACKAGE
 SCALE:20X

4219013/A 05/2017

NOTES: (continued)

6. Laser cutting apertures with trapezoidal walls and rounded corners may offer better paste release. IPC-7525 may have alternate design recommendations.

IMPORTANT NOTICE

Texas Instruments Incorporated (TI) reserves the right to make corrections, enhancements, improvements and other changes to its semiconductor products and services per JESD46, latest issue, and to discontinue any product or service per JESD48, latest issue. Buyers should obtain the latest relevant information before placing orders and should verify that such information is current and complete.

TI's published terms of sale for semiconductor products (<http://www.ti.com/sc/docs/stdterms.htm>) apply to the sale of packaged integrated circuit products that TI has qualified and released to market. Additional terms may apply to the use or sale of other types of TI products and services.

Reproduction of significant portions of TI information in TI data sheets is permissible only if reproduction is without alteration and is accompanied by all associated warranties, conditions, limitations, and notices. TI is not responsible or liable for such reproduced documentation. Information of third parties may be subject to additional restrictions. Resale of TI products or services with statements different from or beyond the parameters stated by TI for that product or service voids all express and any implied warranties for the associated TI product or service and is an unfair and deceptive business practice. TI is not responsible or liable for any such statements.

Buyers and others who are developing systems that incorporate TI products (collectively, "Designers") understand and agree that Designers remain responsible for using their independent analysis, evaluation and judgment in designing their applications and that Designers have full and exclusive responsibility to assure the safety of Designers' applications and compliance of their applications (and of all TI products used in or for Designers' applications) with all applicable regulations, laws and other applicable requirements. Designer represents that, with respect to their applications, Designer has all the necessary expertise to create and implement safeguards that (1) anticipate dangerous consequences of failures, (2) monitor failures and their consequences, and (3) lessen the likelihood of failures that might cause harm and take appropriate actions. Designer agrees that prior to using or distributing any applications that include TI products, Designer will thoroughly test such applications and the functionality of such TI products as used in such applications.

TI's provision of technical, application or other design advice, quality characterization, reliability data or other services or information, including, but not limited to, reference designs and materials relating to evaluation modules, (collectively, "TI Resources") are intended to assist designers who are developing applications that incorporate TI products; by downloading, accessing or using TI Resources in any way, Designer (individually or, if Designer is acting on behalf of a company, Designer's company) agrees to use any particular TI Resource solely for this purpose and subject to the terms of this Notice.

TI's provision of TI Resources does not expand or otherwise alter TI's applicable published warranties or warranty disclaimers for TI products, and no additional obligations or liabilities arise from TI providing such TI Resources. TI reserves the right to make corrections, enhancements, improvements and other changes to its TI Resources. TI has not conducted any testing other than that specifically described in the published documentation for a particular TI Resource.

Designer is authorized to use, copy and modify any individual TI Resource only in connection with the development of applications that include the TI product(s) identified in such TI Resource. NO OTHER LICENSE, EXPRESS OR IMPLIED, BY ESTOPPEL OR OTHERWISE TO ANY OTHER TI INTELLECTUAL PROPERTY RIGHT, AND NO LICENSE TO ANY TECHNOLOGY OR INTELLECTUAL PROPERTY RIGHT OF TI OR ANY THIRD PARTY IS GRANTED HEREIN, including but not limited to any patent right, copyright, mask work right, or other intellectual property right relating to any combination, machine, or process in which TI products or services are used. Information regarding or referencing third-party products or services does not constitute a license to use such products or services, or a warranty or endorsement thereof. Use of TI Resources may require a license from a third party under the patents or other intellectual property of the third party, or a license from TI under the patents or other intellectual property of TI.

TI RESOURCES ARE PROVIDED "AS IS" AND WITH ALL FAULTS. TI DISCLAIMS ALL OTHER WARRANTIES OR REPRESENTATIONS, EXPRESS OR IMPLIED, REGARDING RESOURCES OR USE THEREOF, INCLUDING BUT NOT LIMITED TO ACCURACY OR COMPLETENESS, TITLE, ANY EPIDEMIC FAILURE WARRANTY AND ANY IMPLIED WARRANTIES OF MERCHANTABILITY, FITNESS FOR A PARTICULAR PURPOSE, AND NON-INFRINGEMENT OF ANY THIRD PARTY INTELLECTUAL PROPERTY RIGHTS. TI SHALL NOT BE LIABLE FOR AND SHALL NOT DEFEND OR INDEMNIFY DESIGNER AGAINST ANY CLAIM, INCLUDING BUT NOT LIMITED TO ANY INFRINGEMENT CLAIM THAT RELATES TO OR IS BASED ON ANY COMBINATION OF PRODUCTS EVEN IF DESCRIBED IN TI RESOURCES OR OTHERWISE. IN NO EVENT SHALL TI BE LIABLE FOR ANY ACTUAL, DIRECT, SPECIAL, COLLATERAL, INDIRECT, PUNITIVE, INCIDENTAL, CONSEQUENTIAL OR EXEMPLARY DAMAGES IN CONNECTION WITH OR ARISING OUT OF TI RESOURCES OR USE THEREOF, AND REGARDLESS OF WHETHER TI HAS BEEN ADVISED OF THE POSSIBILITY OF SUCH DAMAGES.

Unless TI has explicitly designated an individual product as meeting the requirements of a particular industry standard (e.g., ISO/TS 16949 and ISO 26262), TI is not responsible for any failure to meet such industry standard requirements.

Where TI specifically promotes products as facilitating functional safety or as compliant with industry functional safety standards, such products are intended to help enable customers to design and create their own applications that meet applicable functional safety standards and requirements. Using products in an application does not by itself establish any safety features in the application. Designers must ensure compliance with safety-related requirements and standards applicable to their applications. Designer may not use any TI products in life-critical medical equipment unless authorized officers of the parties have executed a special contract specifically governing such use. Life-critical medical equipment is medical equipment where failure of such equipment would cause serious bodily injury or death (e.g., life support, pacemakers, defibrillators, heart pumps, neurostimulators, and implantables). Such equipment includes, without limitation, all medical devices identified by the U.S. Food and Drug Administration as Class III devices and equivalent classifications outside the U.S.

TI may expressly designate certain products as completing a particular qualification (e.g., Q100, Military Grade, or Enhanced Product). Designers agree that it has the necessary expertise to select the product with the appropriate qualification designation for their applications and that proper product selection is at Designers' own risk. Designers are solely responsible for compliance with all legal and regulatory requirements in connection with such selection.

Designer will fully indemnify TI and its representatives against any damages, costs, losses, and/or liabilities arising out of Designer's non-compliance with the terms and provisions of this Notice.

Looking for pricing, stock, or lifecycle information?

Click below to explore more details on WIN SOURCE:

 [View BQ24705RGERG4](#) on WIN SOURCE

 [Texas Instruments](#) Information

Optimize Your Supply Chain with WIN SOURCE Solutions

-  Global Sourcing Solution
-  Obsolete Management
-  Cost Control Management
-  Shortage Management
-  Alternative Solution
-  Excess Inventory Management