



**THE DATASHEET OF  
CGRMT4006-HF**



## CGRMT4001-HF Thru. CGRMT4007-HF

Reverse Voltage: 50 to 1000 Volts

Forward Current: 1.0 Amp

RoHS Device

Halogen Free

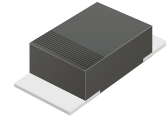

### Features

- Excellent power dissipation offers better reverse leakage current and thermal resistance.
- Low profile package is 40% thinner than standards SOD-123 .
- Tiny plastic SMD package.
- High current capability.
- High surge capability.
- Glass passivated chip junction.
- Lead-free parts meet environmental standards of MIL-STD-19500/228

### Mechanical data

- Epoxy: UL94-V0 rated flame retardant.
- Case: Molded plastic, SOD-123H/MINI SMA
- Terminals: Solderable per MIL-STD-750, Method 2026.
- Polarity: Indicated by cathode band.
- Mounting Position: any
- Weight: 0.011 grams approx.

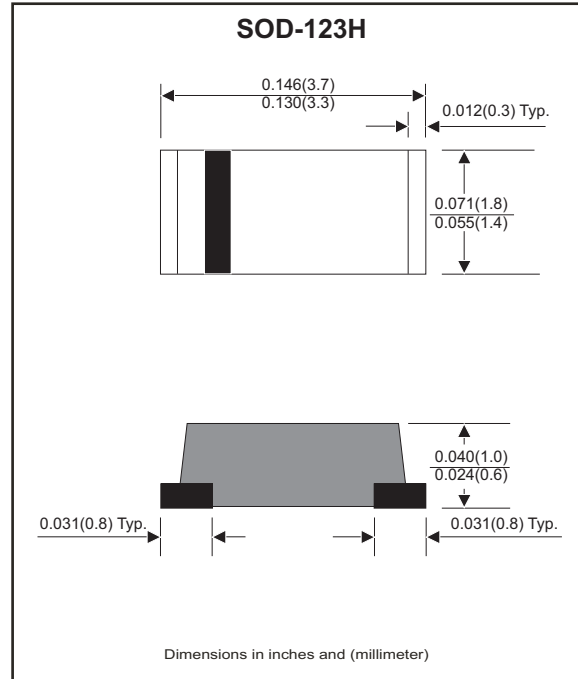

### Maximum Ratings (at TA=25°C unless otherwise noted)

Parameter	Symbol	CGRMT 4001-HF	CGRMT 4002-HF	CGRMT 4003-HF	CGRMT 4004-HF	CGRMT 4005-HF	CGRMT 4006-HF	CGRMT 4007-HF	Unit
Max. repetitive peak reverse voltage	V <sub>RRM</sub>	50	100	200	400	600	800	1000	V
Max. Continuous reverse voltage	V <sub>R</sub>	50	100	200	400	600	800	1000	V
Max. RMS voltage	V <sub>RMS</sub>	35	70	140	280	420	560	700	V
Max. averaged forward current	I <sub>O</sub>	1.0							A
Max. Forward voltage @ I <sub>F</sub> =1.0A	V <sub>F</sub>	1.1							V
Max. Forward surge current 8.3ms single half sine-wave superimposed on rated load (JEDEC method)	I <sub>FSM</sub>	25							A
Max. Reverse current	V <sub>R</sub> =V <sub>RRM</sub> T <sub>J</sub> =25°C	5.0							μA
	V <sub>R</sub> =V <sub>RRM</sub> T <sub>J</sub> =100°C	50							
Typ. Thermal resistance, junction to ambient air	R <sub>θJA</sub>	60							°C/W
Typ. Junction capacitance f=1MHz and applied 4V DC reverse voltage	C <sub>J</sub>	15							pF
Operating junction temperature	T <sub>J</sub>	-55 to +150							°C
Storage temperature range	T <sub>STG</sub>	-65 to +175							°C

## Rating and Characteristic Curves (CGRMT4001-HF Thru. CGRMT4007-HF)

Fig.1- Typical Forward Current Derating Curve

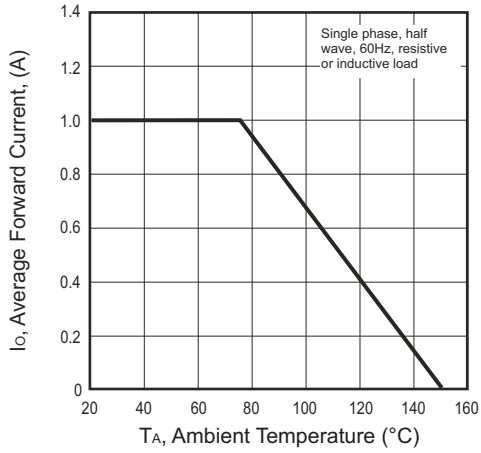

Fig.1- Typical Forward Characteristics

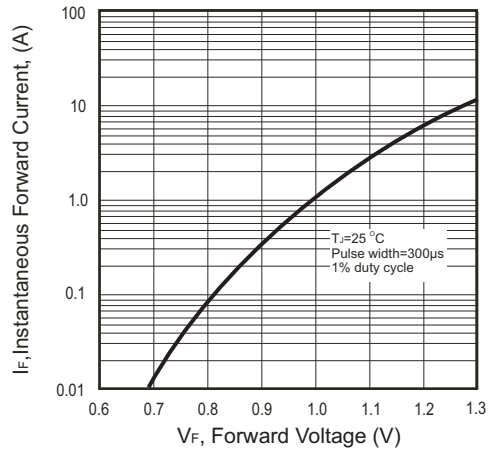

Fig.3- Typical Reverse Characteristics Forward Surge Current

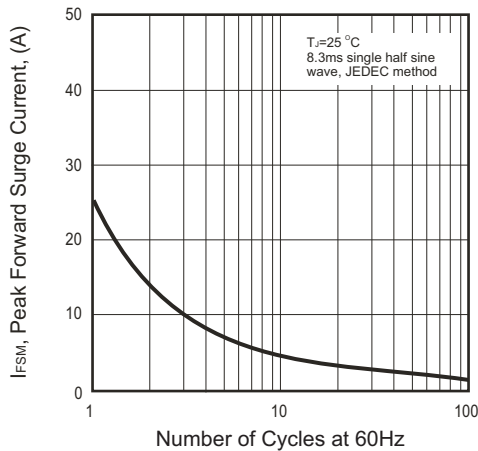

Fig.4- Typical Junction Capacitance

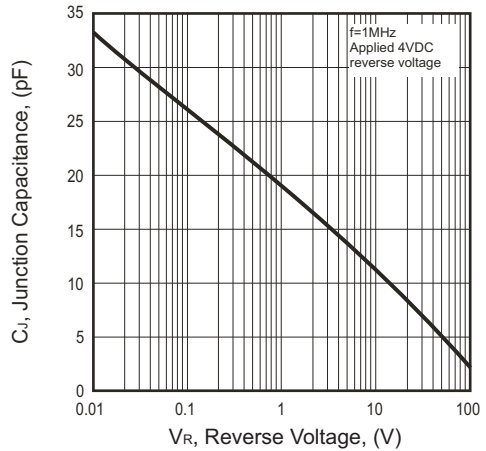
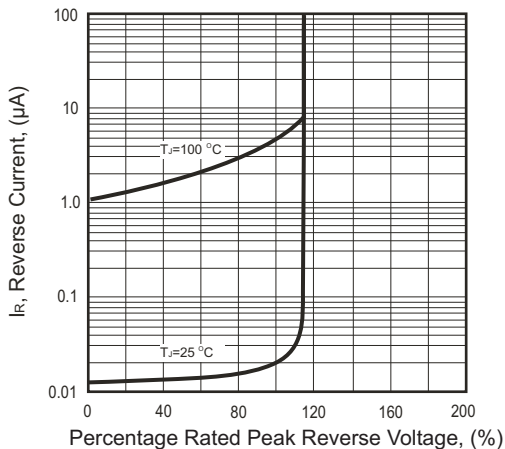
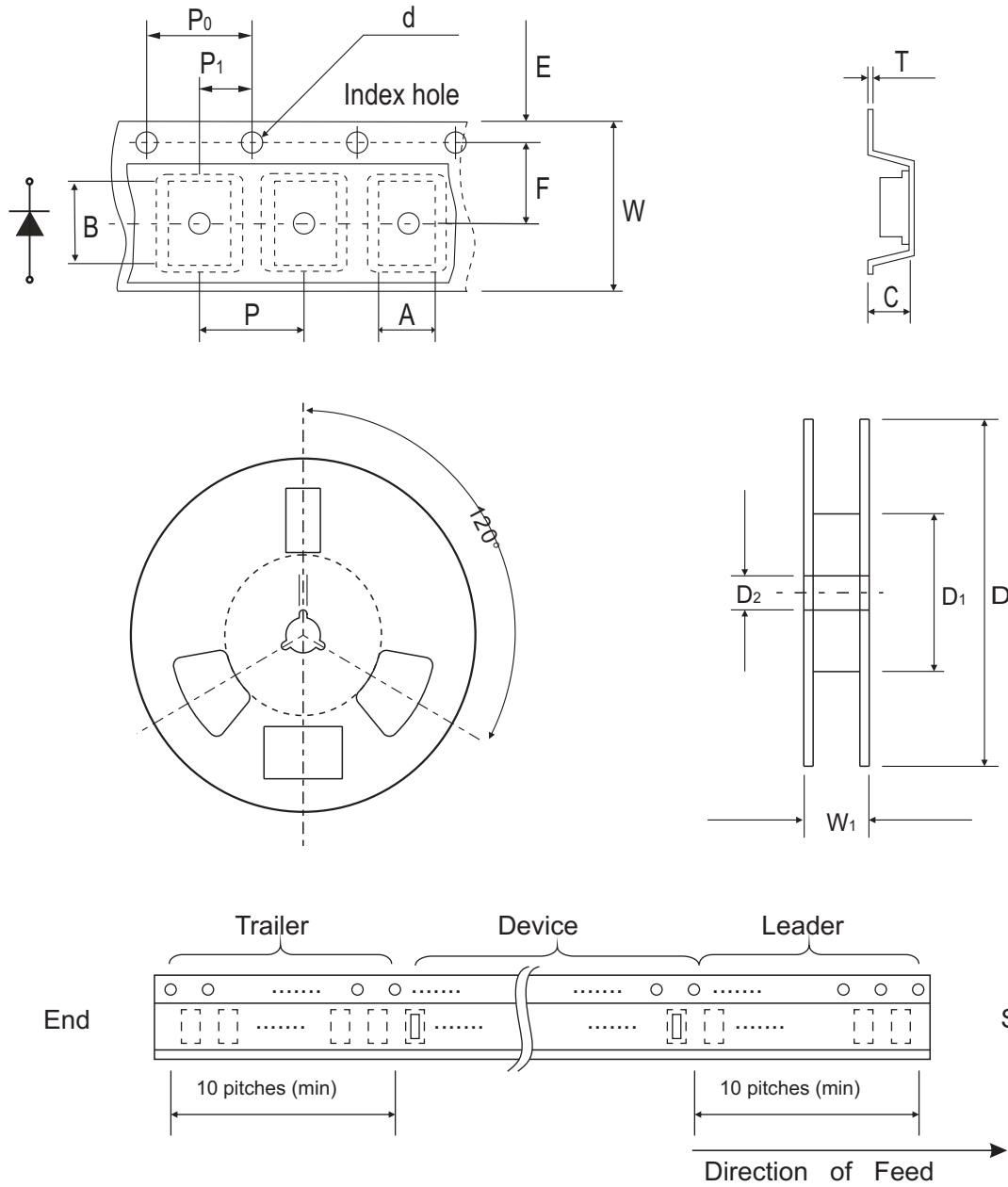

Fig.5- Maximum Non-repetitive





## Reel Taping Specification



SOD-123H	SYMBOL	A	B	C	d	D	D1	D2
	(mm)	$2.00 \pm 0.10$	$3.85 \pm 0.10$	$1.10 \pm 0.10$	$1.50 \pm 0.10$	$178 \pm 2.00$	62.0 MIN.	$13.0 \pm 0.50$
	(inch)	$0.079 \pm 0.004$	$0.152 \pm 0.004$	$0.043 \pm 0.004$	$0.059 \pm 0.004$	$7.00 \pm 0.079$	2.440 MIN.	$0.512 \pm 0.020$

SOD-123H	SYMBOL	E	F	P	P0	P1	T	W	W1
	(mm)	$1.75 \pm 0.10$	$3.50 \pm 0.10$	$4.00 \pm 0.10$	$4.00 \pm 0.10$	$2.00 \pm 0.10$	$0.23 \pm 0.10$	$8.00 \pm 0.30$	$11.40 \pm 1.0$
	(inch)	$0.069 \pm 0.004$	$0.138 \pm 0.004$	$0.157 \pm 0.004$	$0.157 \pm 0.004$	$0.079 \pm 0.004$	$0.009 \pm 0.004$	$0.315 \pm 0.012$	$0.449 \pm 0.039$

## Pinning information

Pin	Simplified outline	Symbol
PIN 1 Cathode PIN 2 Anode		

## Marking Code

Part Number	Marking Code
CGRMT4001-HF	A1
CGRMT4002-HF	A2
CGRMT4003-HF	A3
CGRMT4004-HF	A4
CGRMT4005-HF	A5
CGRMT4006-HF	A6
CGRMT4007-HF	A7



xx = Product type marking code

## Suggested PAD Layout

SIZE	SOD-123H	
	(mm)	(inch)
A	3.00	0.118
B	1.30	0.051
C	1.80	0.071
D	4.30	0.169
E	1.70	0.067

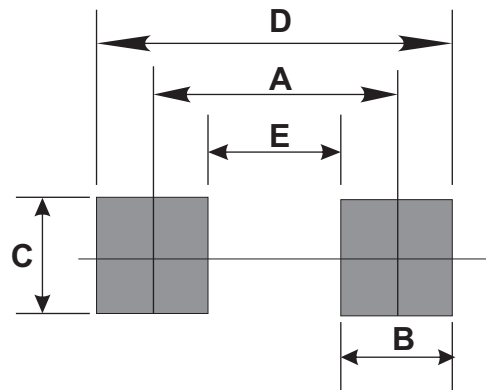



## Standard Packaging

Case Type	REEL PACK	
	REEL (pcs)	Reel Size (inch)
SOD-123H	3,000	7

## Looking for pricing, stock, or lifecycle information?

Click below to explore more details on WIN SOURCE:

-  [View CGRMT4006-HF on WIN SOURCE](#)
-  [Comchip Technology Information](#)

## Optimize Your Supply Chain with WIN SOURCE Solutions

-  Global Sourcing Solution
-  Obsolete Management
-  Cost Control Management
-  Shortage Management
-  Alternative Solution
-  Excess Inventory Management