



**THE DATASHEET OF
CGRMT4004-HF**



CGRMT4004-HF Thru. CGRMT4007-HF

Reverse Voltage: 50 to 1000 Volts

Forward Current: 1.0 Amp

RoHS Device

Halogen Free

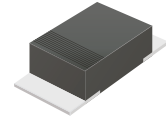

Features

- Excellent power dissipation offers better reverse leakage current and thermal resistance.
- Low profile surface mounted application in order to optimize board space.
- Tiny plastic SMD package.
- High current capability.
- High surge capability.
- Glass passivated chip junction.
- Lead-free parts meet environmental standards of MIL-STD-19500/228

Mechanical data

- Epoxy: UL94V-0 rated flame retardant.
- Case: Molded plastic, SOD-123H/MINI SMA
- Terminals: Solderable per MIL-STD-750, Method 2026.
- Polarity: Indicated by cathode band.
- Mounting Position: any
- Weight: 0.011 grams approx.

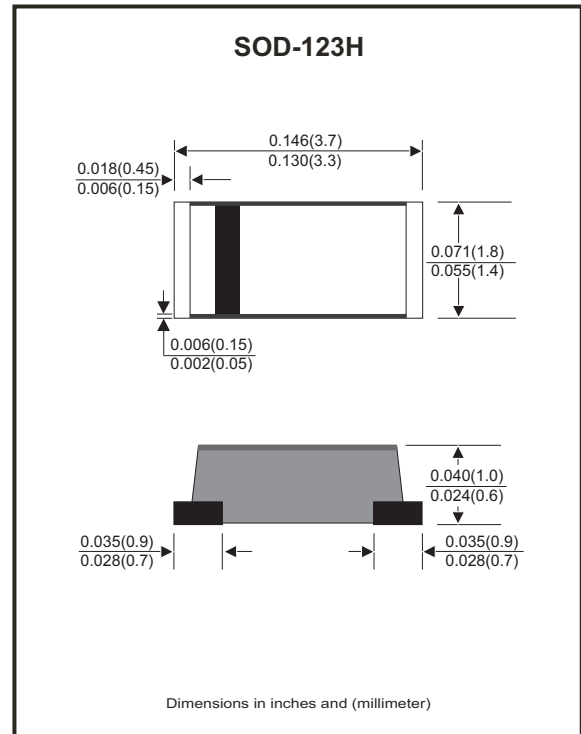

Maximum Ratings and Electrical Characteristics (at T_A=25°C unless otherwise noted)

Parameter	Symbol	CGRMT 4004-HF	CGRMT 4005-HF	CGRMT 4007-HF	Unit
Max. Repetitive peak reverse voltage	V _{RRM}	400	600	1000	V
Max. Continuous reverse voltage	V _R	400	600	1000	V
Max. RMS voltage	V _{RMS}	280	420	700	V
Max. Averaged forward current	I _O	1.0			A
Max. Forward voltage @ I _F =1.0A	V _F	1.1			V
Max. Forward surge current 8.3ms single half sine-wave superimposed on rated load (JEDEC method)	I _{FSM}	25			A
Max. Reverse current	I _R	V _R =V _{RRM} T _J =25°C	5.0		μA
		V _R =V _{RRM} T _J =125°C	50		
Typ. Thermal resistance, junction to ambient air	R _{θJA}	60			°C/W
Typ. Junction capacitance f=1MHz and applied 4V DC reverse voltage	C _J	15			pF
Operating junction temperature	T _J	-55 to +150			°C
Storage temperature range	T _{STG}	-65 to +175			°C

Rating and Characteristic Curves (CGRMT4004-HF Thru. CGRMT4007-HF)

Fig.1 - Typical Forward Current Derating Curve

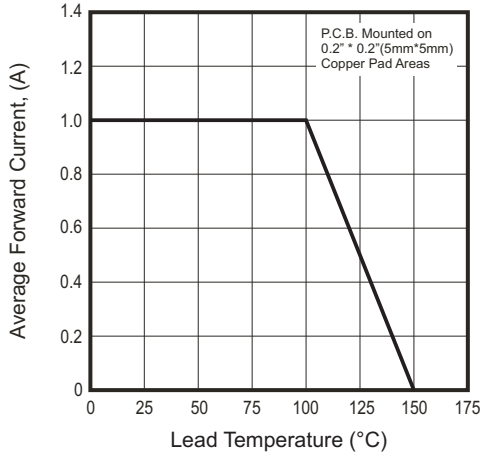

Fig.2 - Typical Forward Characteristics

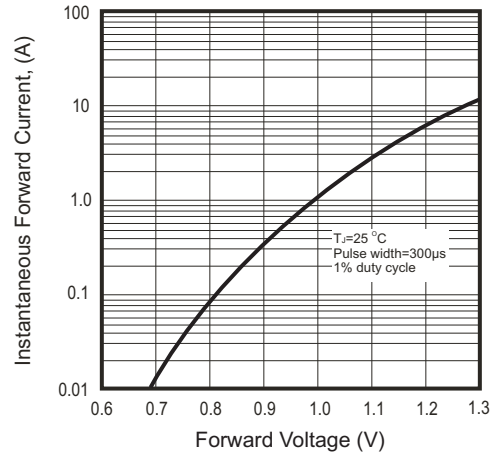

Fig.3 - Maximum Non-repetitive Forward Surge Current

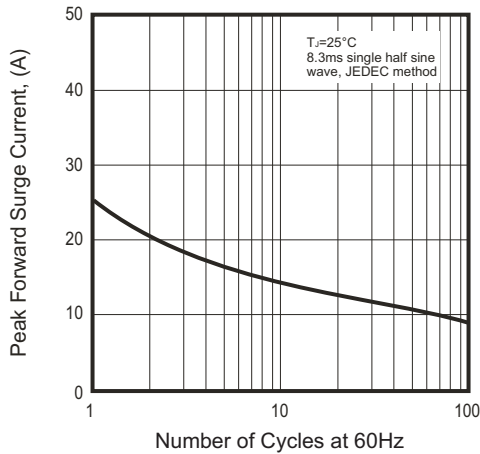

Fig.4 - Typical Junction Capacitance

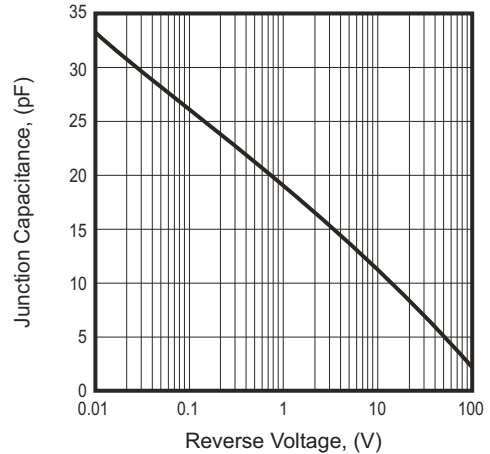
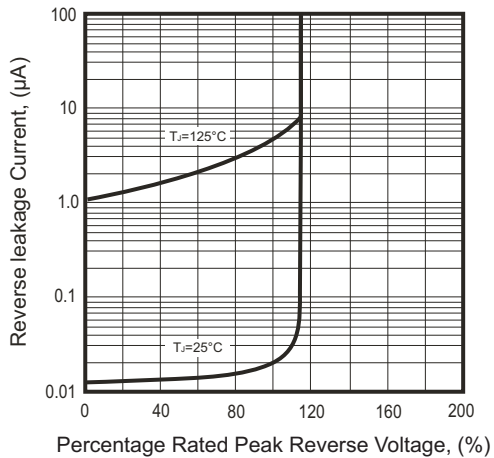
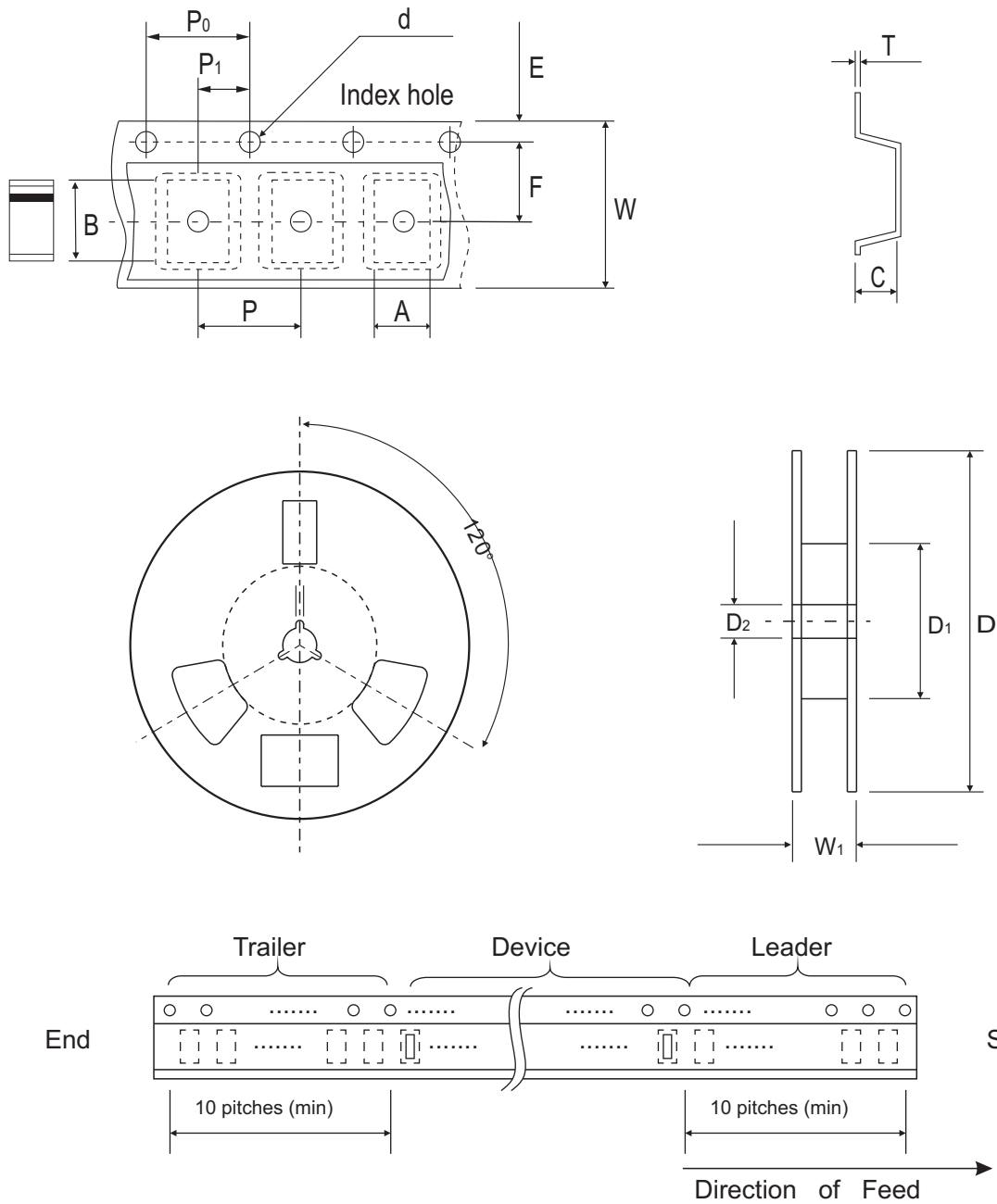

Fig.5 - Typical Reverse Characteristics





Reel Taping Specification



SOD-123H	SYMBOL	A	B	C	d	D	D1	D2
	(mm)	2.00 ± 0.10	3.85 ± 0.10	1.10 ± 0.10	1.50 ± 0.10	178.00 ± 2.00	62.00 (min)	13.00 ± 0.50
	(inch)	0.079 ± 0.004	0.152 ± 0.004	0.043 ± 0.004	0.059 ± 0.004	7.007 ± 0.079	2.441 (min)	0.512 ± 0.020

SOD-123H	SYMBOL	E	F	P	P0	P1	T	W	W1
	(mm)	1.75 ± 0.10	3.50 ± 0.10	4.00 ± 0.10	4.00 ± 0.10	2.00 ± 0.10	0.23 ± 0.10	8.00 ± 0.30	11.40 ± 1.00
	(inch)	0.069 ± 0.004	0.138 ± 0.004	0.157 ± 0.004	0.157 ± 0.004	0.079 ± 0.004	0.009 ± 0.04	0.315 ± 0.012	0.449 ± 0.039

Pinning information

Pin	Simplified outline	Symbol
PIN 1 Cathode PIN 2 Anode		

Marking Code

Part Number	Marking Code
CGRMT4004-HF	A4
CGRMT4005-HF	A5
CGRMT4007-HF	A7



xx = Product type marking code

Suggested PAD Layout

SIZE	SOD-123H	
	(mm)	(inch)
A	3.00	0.118
B	1.30	0.051
C	1.80	0.071
D	4.30	0.169
E	1.70	0.067

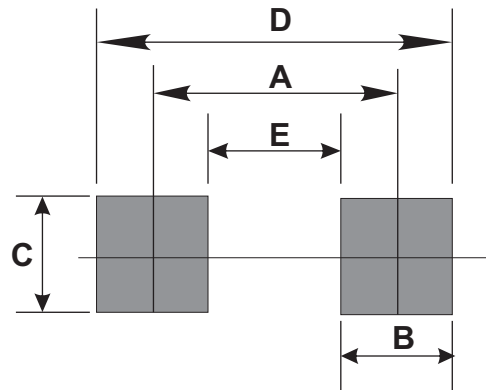



Standard Packaging

Case Type	REEL PACK	
	REEL (pcs)	Reel Size (inch)
SOD-123H	3,000	7

Looking for pricing, stock, or lifecycle information?

Click below to explore more details on WIN SOURCE:

-  [View CGRMT4004-HF on WIN SOURCE](#)
-  [Comchip Technology Information](#)

Optimize Your Supply Chain with WIN SOURCE Solutions

-  Global Sourcing Solution
-  Obsolete Management
-  Cost Control Management
-  Shortage Management
-  Alternative Solution
-  Excess Inventory Management