



THE DATASHEET OF PLA193STR





Parameters	Ratings	Units
Blocking Voltage	600	V_P
Load Current	100	mA_{rms} / mA_{DC}
On-Resistance (max)	50	Ω
LED Current to Operate	5	mA

Features

- PLA193E is 100% Tested for Partial Discharge: DIN EN 60747-5-5
- 5000V_{rms} Input/Output Isolation
- Low Drive Power Requirements
- High Reliability
- Arc-Free With No Snubbing Circuits
- No EMI/RFI Generation
- Small 6-Pin Package
- Flammability Rating UL 94 V-0

Applications

- Instrumentation
- Multiplexers
- Data Acquisition
- Electronic Switching
- I/O Subsystems
- Meters (Watt-Hour, Water, Gas)
- Medical Equipment—Patient/Equipment Isolation
- Security
- Aerospace
- Industrial Controls

Pin Configuration

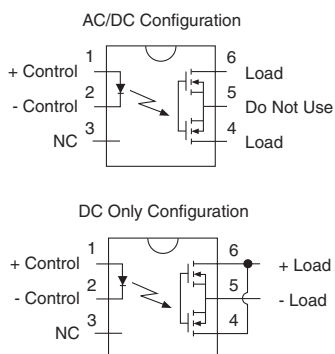

Description

IXYS Integrated Circuits' PLA193 is a single-pole, normally open (1-Form-A) solid state relay that provides 5000V_{rms} of input to output isolation.

In addition to all the features and benefits of the PLA193, the PLA193E meets the partial discharge demands of DIN EN 60747-5-5 (Previously VDE 0884).

All versions of the PLA193 can be used to replace mechanical relays, while offering the superior reliability associated with semiconductor devices. Optically coupled outputs that use the patented OptoMOS architecture are controlled by a highly efficient infrared LED. Because they have no moving parts, they offer bounce-free switching in more compact surface mount or thru-hole packages.

Approvals

- UL Recognized Component: File E76270
- CSA Certified Component: Certificate 1175739
- DIN EN 60747-5-5 Certified ("E" Suffix Only)
VDE Certificate 40036603
- EN/IEC 60950-1 Certified Component:
[Certificate available on our website](#)

Ordering Information

Part #	Description
PLA193E	6-Pin DIP (50/Tube)
PLA193ES	6-Pin Surface Mount (50/Tube)
PLA193ESTR	6-Pin Surface Mount (1000/Reel)
PLA193	6-Pin DIP (50/Tube)
PLA193S	6-Pin Surface Mount (50/Tube)
PLA193STR	6-Pin Surface Mount (1000/Reel)

Switching Characteristics of Normally Open Devices

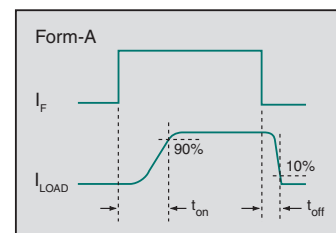

Absolute Maximum Ratings (@25°C Unless Otherwise Noted)

Parameter	Ratings	Units
Peak Blocking Voltage	600	V _P
Reverse Input Voltage	5	V
Input Control Current	50	mA
Peak (10ms)	1	A
Input Power Dissipation ¹	150	mW
Total Package Dissipation ²	800	mW
ESD Rating, Human Body Model	8	kV
Isolation Voltage, Input to Output (60 Seconds)	5000	V _{rms}
Operational Temperature	-40 to +85	°C
Storage Temperature	-40 to +125	°C

¹ Derate linearly 1.33 mW / °C
² Derate linearly 6.67 mW / °C

Absolute Maximum Ratings are stress ratings. Stresses in excess of these ratings can cause permanent damage to the device. Functional operation of the device at conditions beyond those indicated in the operational sections of this data sheet is not implied.

Typical values are characteristic of the device at +25°C, and are the result of engineering evaluations. They are provided for information purposes only, and are not part of the manufacturing testing requirements.

Electrical Characteristics (@25°C Unless Otherwise Noted)

Parameters	Conditions	Symbol	Min	Typ	Max	Units
Output Characteristics						
Load Current, Continuous						
AC/DC Configuration	-	I _L	-	-	100	mA _{rms} / mA _{DC}
DC-Only Configuration			-	-	190	mA _{DC}
Peak Load Current	t=10ms	I _{LPK}	-	-	±350	mA _P
On-Resistance ¹						
AC/DC Configuration	I _F =5mA, I _L =100mA	R _{ON}	-	25	50	Ω
DC-Only Configuration	I _F =5mA, I _L =190mA		-	10	18	
Off-State Leakage Current	I _F =0V, V _L =600V _P	I _{LEAK}	-	-	1	μA
Switching Speeds						
Turn-On	I _F =5mA, V _L =10V	t _{on}	-	0.6	5	ms
Turn-Off		t _{off}	-	0.3	5	ms
Output Capacitance	I _F =0mA, V _L =50V, f=1MHz	C _{OUT}	-	5	-	pF
Input Characteristics						
Input Control Current to Activate	I _L =100mA	I _F	-	0.45	5	mA
Input Control Current to Deactivate	-	I _F	0.3	0.44	-	mA
Input Voltage Drop	I _F =5mA	V _F	0.9	1.2	1.5	V
Reverse Input Current	V _R =5V	I _R	-	-	10	μA
Common Characteristics						
Input to Output Capacitance	V _{IO} =0V, f=1MHz	C _{IO}	-	3	-	pF

¹ Measurement taken within 1 second of on-time.

PLA193E Safety and Insulation Ratings

Parameters	Conditions	Symbol	Min	Max	Units
Pollution Degree 2 according to DIN VDE 0109	-	-	-	-	-
Highest Allowable Over-Voltage	Transient Voltage	V _{IOTM}	7071	-	V _P
Maximum Working Insulation Voltage	Recurring Voltage	V _{IORM}	1000	-	V _P
Partial Discharge Test Voltage	DIN EN 60747-5-5 Method B	V _{PR}	-	1875	V _P
Isolation Test Voltage	-	V _{ISO}	-	5000	V _{rms}
Creepage Distance	-	-	7.6	-	mm
Clearance Distance	-	-	7.6	-	mm

PERFORMANCE DATA*

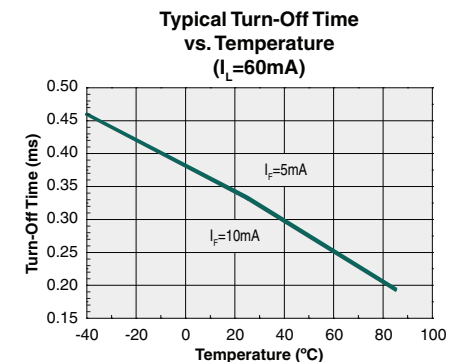
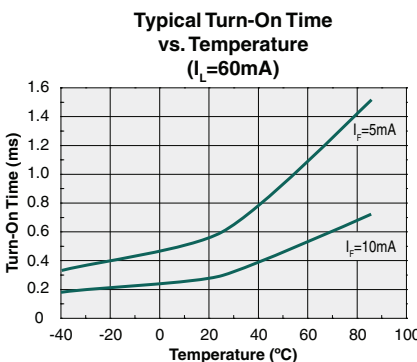
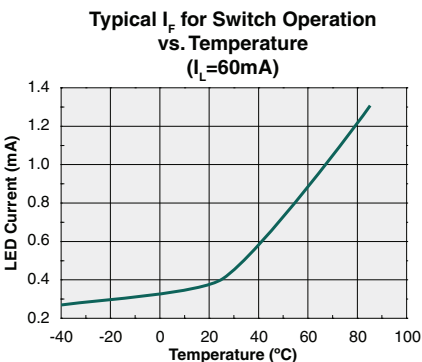
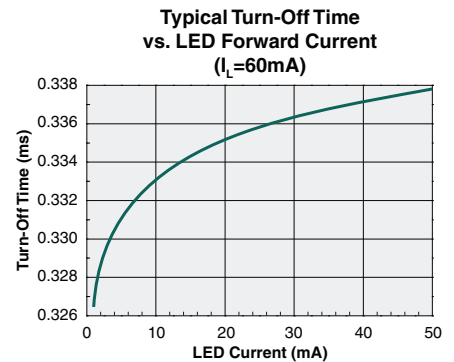
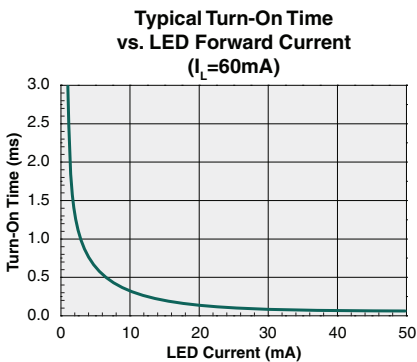
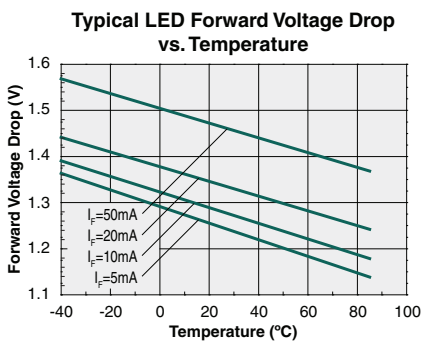
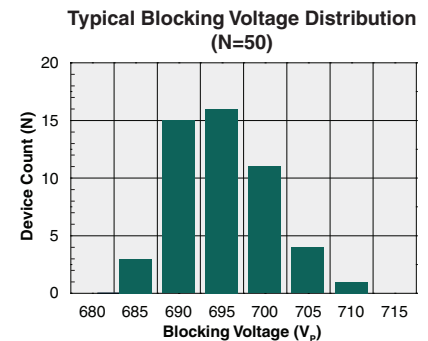
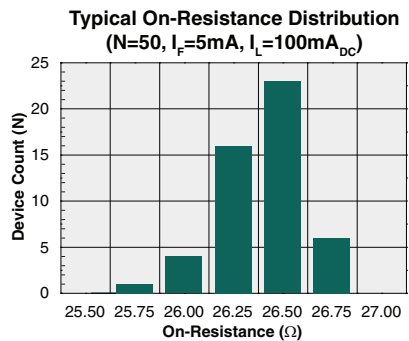
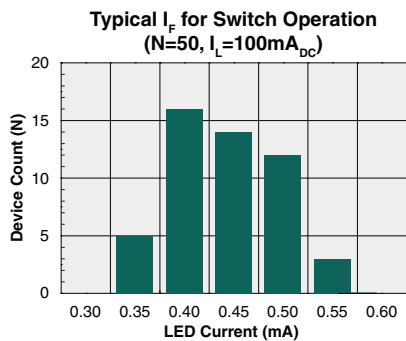
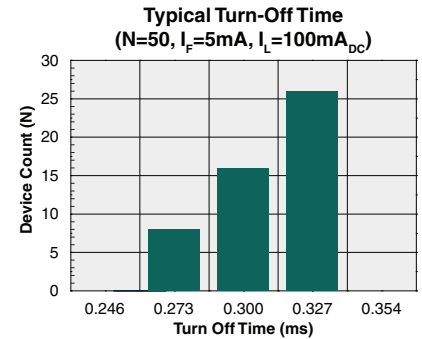
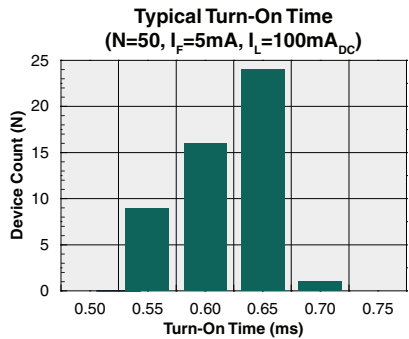
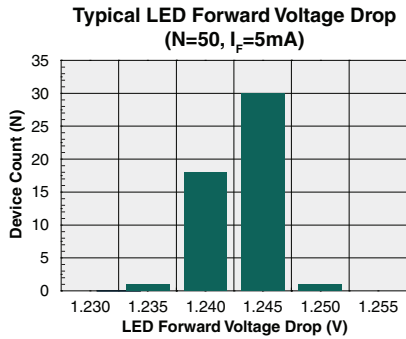

*Unless otherwise noted, data presented in these graphs is typical of device operation at 25°C.
For guaranteed parameters not indicated in the written specifications, please contact our application department.

PERFORMANCE DATA*

Typical On-Resistance vs. Temperature
($I_F=5mA, I_L=60mA$)

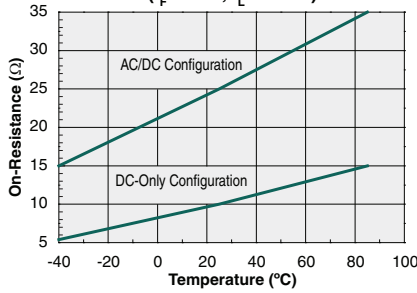

Typical Load Current vs. Load Voltage
DC-Only Configuration
($I_F=5mA$)

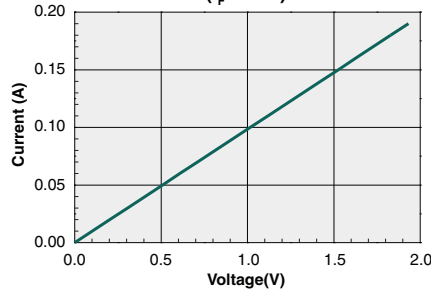

Typical Load Current vs. Load Voltage
AC/DC Configuration
($I_F=5mA$)

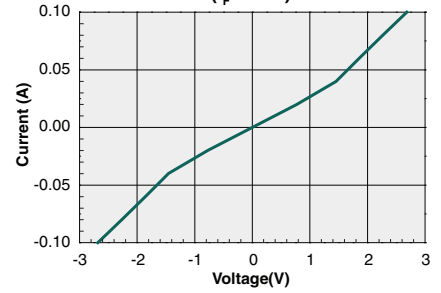

Maximum Load Current vs. Temperature
($I_F=5mA$)

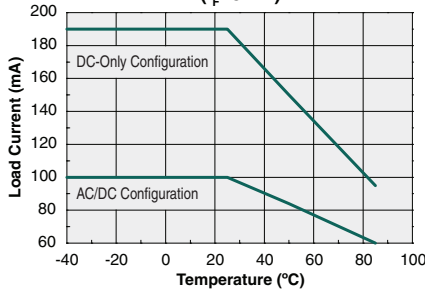

Typical Blocking Voltage vs. Temperature

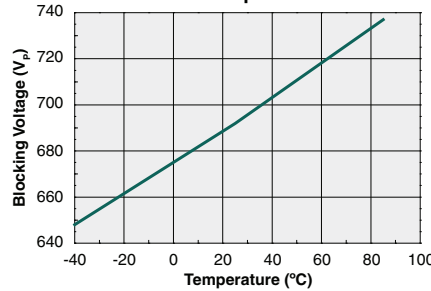

Typical Leakage vs. Temperature
Measured Across Pins 4&6
($V_L=600V_p$)

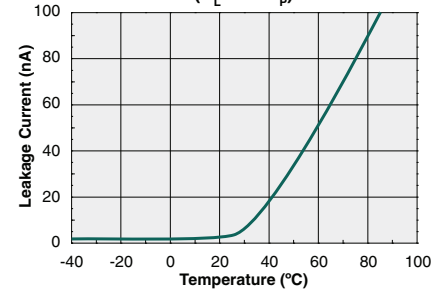

Output Capacitance vs. Load Voltage
($I_F=0mA, f=1MHz$)

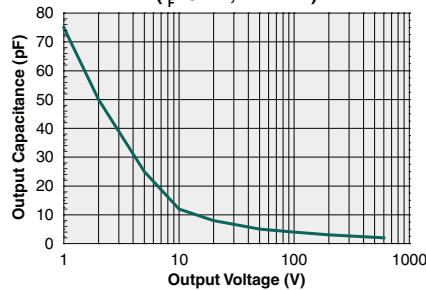

Energy Rating Curve

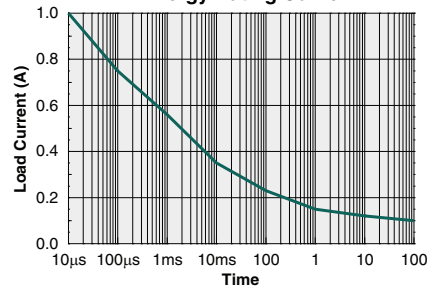

*Unless otherwise noted, data presented in these graphs is typical of device operation at 25°C. For guaranteed parameters not indicated in the written specifications, please contact our application department.

Manufacturing Information

Moisture Sensitivity



All plastic encapsulated semiconductor packages are susceptible to moisture ingress. IXYS Integrated Circuits classifies its plastic encapsulated devices for moisture sensitivity according to the latest version of the joint industry standard, **IPC/JEDEC J-STD-020**, in force at the time of product evaluation. We test all of our products to the maximum conditions set forth in the standard, and guarantee proper operation of our devices when handled according to the limitations and information in that standard as well as to any limitations set forth in the information or standards referenced below.

Failure to adhere to the warnings or limitations as established by the listed specifications could result in reduced product performance, reduction of operable life, and/or reduction of overall reliability.

This product carries a Moisture Sensitivity Level (MSL) classification as shown below, and should be handled according to the requirements of the latest version of the joint industry standard **IPC/JEDEC J-STD-033**.

Device	Moisture Sensitivity Level (MSL) Classification
PLA193, PLA193S, PLA193E, PLA193ES	MSL 1

ESD Sensitivity



This product is **ESD Sensitive**, and should be handled according to the industry standard **JESD-625**.

Soldering Profile

Provided in the table below is the Classification Temperature (T_C) of this product and the maximum dwell time the body temperature of this device may be ($T_C - 5$)°C or greater. The classification temperature sets the Maximum Body Temperature allowed for this device during lead-free reflow processes. For through-hole devices, and any other processes, the guidelines of **J-STD-020** must be observed.

Device	Classification Temperature (T_C)	Dwell Time (t_p)	Max Reflow Cycles
PLA193, PLA193E	250°C	30 seconds	1
PLA193S, PLA193ES	250°C	30 seconds	3

Board Wash

IXYS Integrated Circuits recommends the use of no-clean flux formulations. Board washing to reduce or remove flux residue following the solder reflow process is acceptable provided proper precautions are taken to prevent damage to the device. These precautions include, but are not limited to: using a low pressure wash and providing a follow up bake cycle sufficient to remove any moisture trapped within the device due to the washing process. Due to the variability of the wash parameters used to clean the board, determination of the bake temperature and duration necessary to remove the moisture trapped within the package is the responsibility of the user (assembler). Cleaning or drying methods that employ ultrasonic energy may damage the device and should not be used. Additionally, the device must not be exposed to flux or solvents that are Chlorine- or Fluorine-based.



MECHANICAL DIMENSIONS

PLA193 & PLA193E

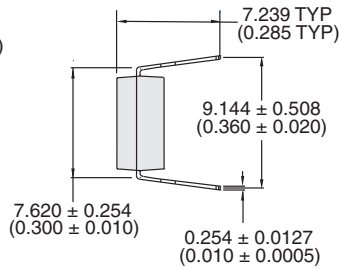
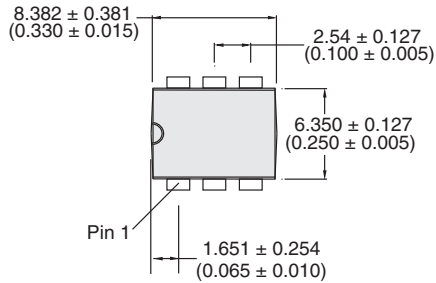

PCB Hole Pattern

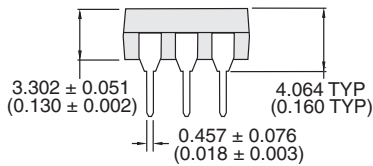
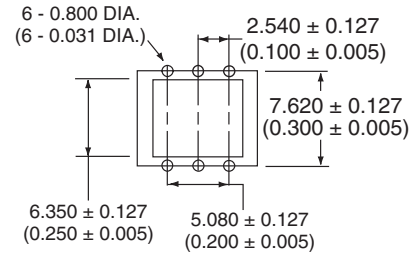

Dimensions
mm
(inches)

PLA193S & PLA193ES

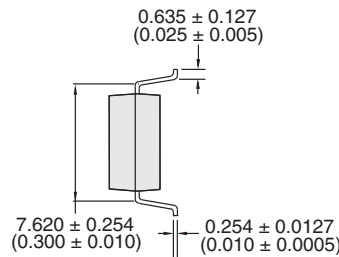
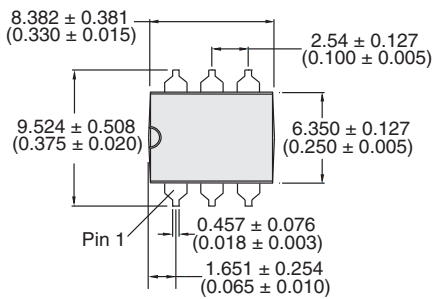

PCB Land Pattern

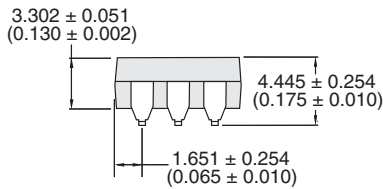
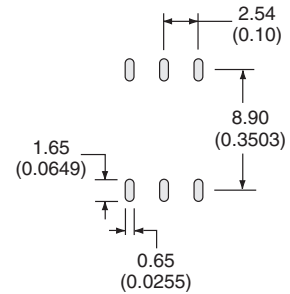

Dimensions
mm
(inches)

PLA193STR & PLA193ESTR Tape & Reel

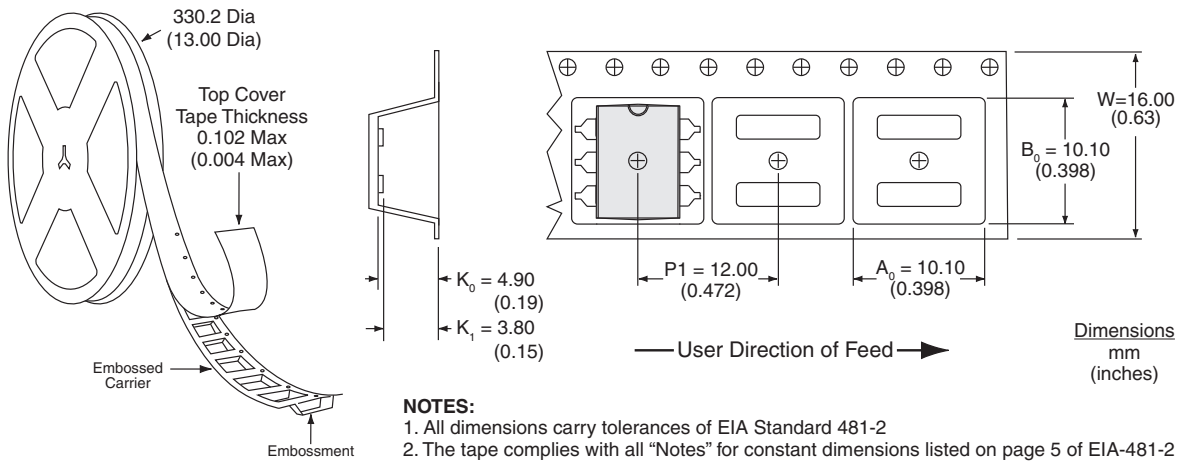

For additional information please visit our website at: www.ixysic.com

IXYS Integrated Circuits makes no representations or warranties with respect to the accuracy or completeness of the contents of this publication and reserves the right to make changes to specifications and product descriptions at any time without notice. Neither circuit patent licenses nor indemnity are expressed or implied. Except as set forth in IXYS Integrated Circuits' Standard Terms and Conditions of Sale, IXYS Integrated Circuits assumes no liability whatsoever, and disclaims any express or implied warranty, relating to its products including, but not limited to, the implied warranty of merchantability, fitness for a particular purpose, or infringement of any intellectual property right.

The products described in this document are not designed, intended, authorized or warranted for use as components in systems intended for surgical implant into the body, or in other applications intended to support or sustain life, or where malfunction of IXYS Integrated Circuits' product may result in direct physical harm, injury, or death to a person or severe property or environmental damage. IXYS Integrated Circuits reserves the right to discontinue or make changes to its products at any time without notice.

Looking for pricing, stock, or lifecycle information?

Click below to explore more details on WIN SOURCE:

 [View PLA193STR on WIN SOURCE](#)

 [IXYS Information](#)

Optimize Your Supply Chain with WIN SOURCE Solutions

-  Global Sourcing Solution
-  Obsolete Management
-  Cost Control Management
-  Shortage Management
-  Alternative Solution
-  Excess Inventory Management