

Monaural Microphone Amplifier with ALC

■ GENERAL DESCRIPTION

The **NJM2783** is a monaural microphone amplifier with auto level control function to avoid distortion due to clipping. The voltage gain and the limit level are adjustable by external resistors.

It is suitable for mini component audio system, home audio system, karaoke and others.

■ PACKAGE OUTLINE

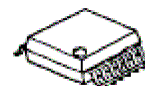

NJM2783V

■ FEATURES

- Operating Voltage +2.7 to +13.0V
- Monaural Microphone Amplifier
- Auto level control (ALC) function
(Adjustable the limit level by external resistors 200mVrms to 2Vrms)
- Adjustable the voltage gain by external resistors +20 to +63dB ($R_{SENSE}=OPEN$)
- Additional Gain Amplifier 0dB/+20dB switchable
- Built-in Buffer Amplifier
- Low Equivalent Input Noise 1 μ Vrms typ.
- Carefully designed to reject RF noise
- Bipolar Technology
- Package Outline SSOP14

■ BLOCK DIAGRAM

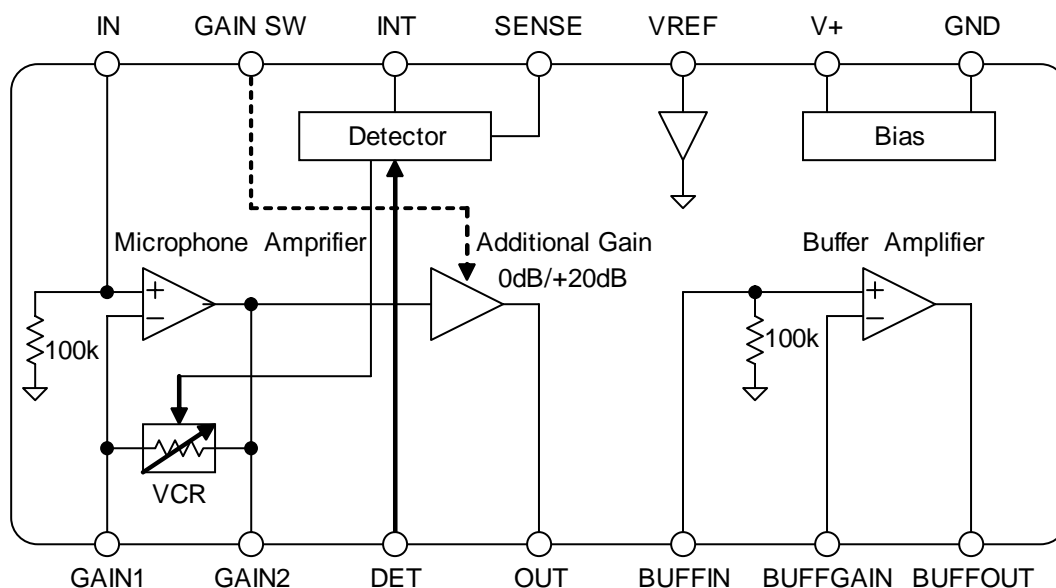

NJM2783

■PIN CONFIGURATION

SSOP14

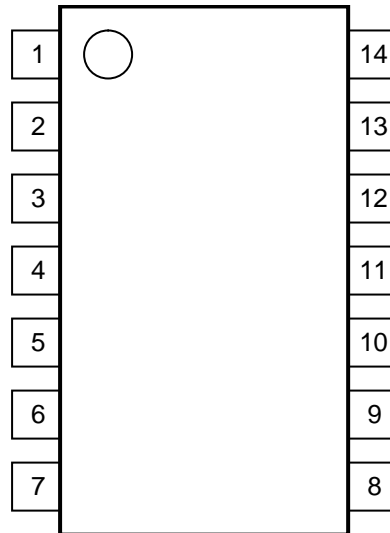

No.	Symbol	Function
1	GAIN1	Microphone Amp Gain Setting 1
2	GAIN2	Microphone Amp Gain Setting 2
3	DET	Detector Input
4	OUT	Microphone Amp Output
5	BUFFIN	Buffer Input
6	BUFFGAIN	Buffer Gain Setting
7	BUFFOUT	Buffer Output
8	GND	Ground
9	V+	Power Supply
10	VREF	Reference Voltage
11	SENSE	Limit Level Setting
12	INT	Recovery Time Setting
13	GAIN SW	Gain Setting
14	IN	Microphone Input

■ABSOLUTE MAXIMUM RATING (Ta=25°C)

PARAMETER	SYMBOL	RATING	UNIT
Power Supply Voltage	V ⁺	+14	V
Power Dissipation	P _D	450 ^{*1)}	mW
Maximum Input Voltage	V _{IMAX}	0 ~ V ⁺ ^{*2)}	V
Operating Temperature Range	Topr	-40 ~ +85	°C
Storage Temperature Range	Tstg	-40 ~ +125	°C

^{*1)} EIA/JEDEC STANDARD Test board (76.2 x 114.3 x 1.6mm, 2layers, FR-4) mounting

^{*2)} Don't put Input Voltage more than Power Supply Voltage.

■RECOMMENDED OPERATING VOLTAGE RANGE (Ta=25°C)

PARAMETER	SYMBOL	TEST CONDITION	MIN.	TYP.	MAX.	UNIT
Operating Voltage Range	V ⁺	-	2.7	9.0	13.0	V

■ELECTRICAL CHARACTERISTICS

●POWER SUPPLY (Ta=25°C, V⁺=9.0V unless otherwise specified)

PARAMETER	SYMBOL	TEST CONDITION	MIN.	TYP.	MAX.	UNIT
Operating Current	I _{CC}	No signal	-	3.5	6.0	mA
Reference Voltage	V _{REF}	No signal	4.2	4.5	4.8	V

●AC CHARACTERISTICS

(Ta=25°C, V⁺=9.0V, V_{IN}=0.7mVrms, f=1kHz, R_{G1}=330Ω, R_{G2}=47kΩ, R_{SENSE}=OPEN, R_L=4.7kΩ, GAIN SW=+20dB unless otherwise specified)

PARAMETER	SYMBOL	TEST CONDITION	MIN.	TYP.	MAX.	UNIT
Voltage Gain 1	G _{V1}		60	63	66	dB
Voltage Gain 2	G _{V2}	GAIN SW=0dB	40	43	46	dB
Maximum Output Voltage	V _{OM}	THD=1%	2.0	2.4	-	Vrms
ALC Level 1	V _{LIM1}	V _{IN} =1.4mVrms R _{SENSE} =47kΩ	0.7	1.0	1.3	Vrms
ALC Level 2	V _{LIM2}	V _{IN} =40mVrms R _{SENSE} =47kΩ	0.7	1.0	1.3	Vrms
ALC Off	V _{OFF}	V _{IN} =1.4mVrms	1.6	2.0	2.4	Vrms
Equivalent Input Noise Voltage	V _{NO}	R _g =0Ω, A-weighted	-	-120 (1.0)	-110 (3.2)	dBV (μVrms)
Total Harmonic Distortion	THD+N	BW=400-30kHz	-	-	1	%
Power Supply Ripple Rejection	RR	V _{ripple} =100mVrms, f=1kHz	-	-35	-20	dB

●CONTROL CHARACTERISTICS (Ta=25°C, V⁺=9.0V unless otherwise specified)

PARAMETER	SYMBOL	TEST CONDITION	MIN.	TYP.	MAX.	UNIT
High Level Input Voltage	V _{IH}	-	2.0	-	V ⁺	V
Low Level Input Voltage	V _{IL}	-	0	-	0.5	V
Control Current	I _{SW}	V _{IH} =5V	-	-	100	μA

NJM2783

CONTROL TERMINAL EXPLANATION

GAIN SW (13 pin)

MODE	STATUS	NOTE
0dB	L	The gain of microphone amplifier is not increased.
+20dB	H	The gain of microphone amplifier is increased +20dB.

TEST CIRCUIT

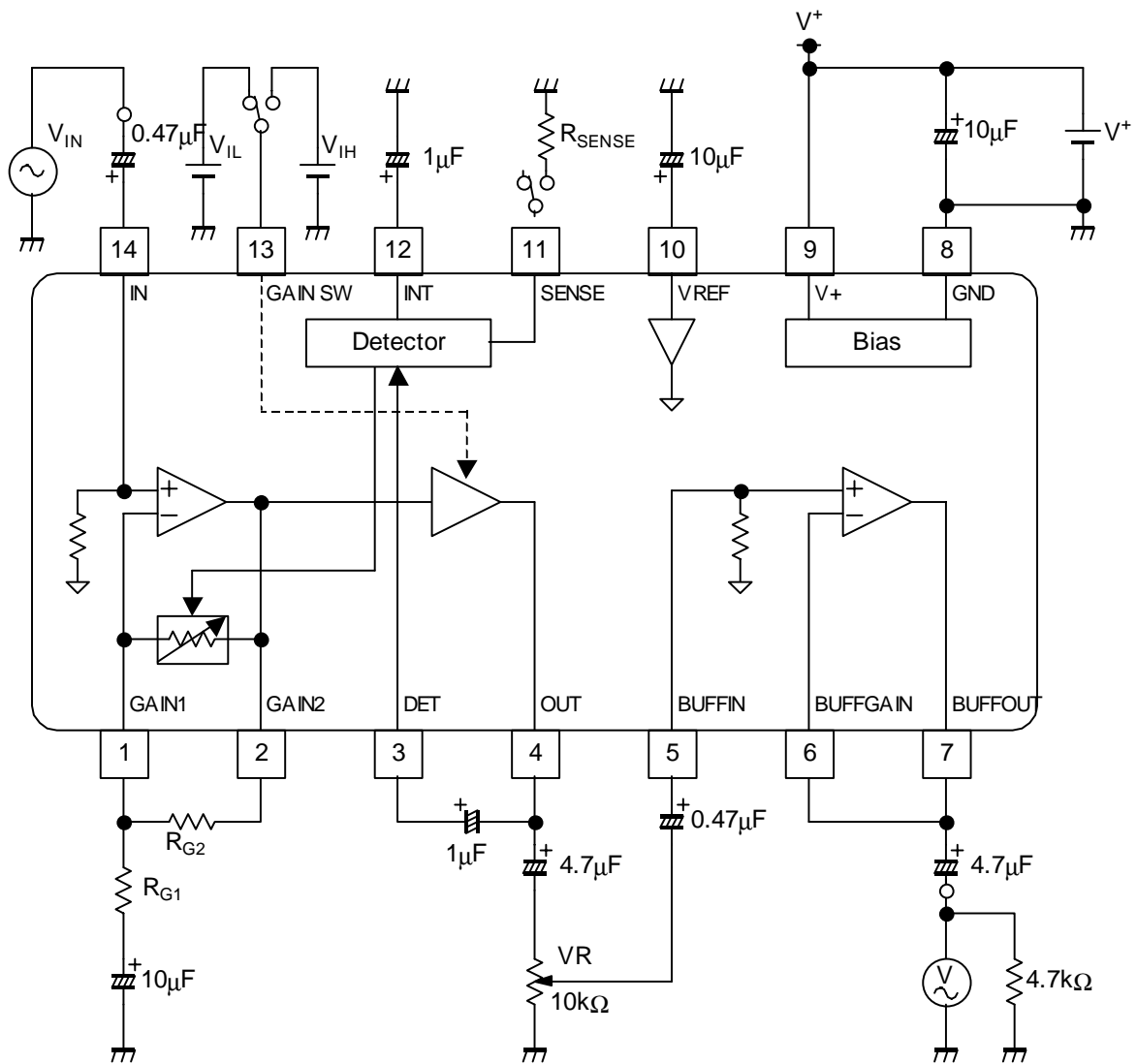

APPLICATION CIRCUIT

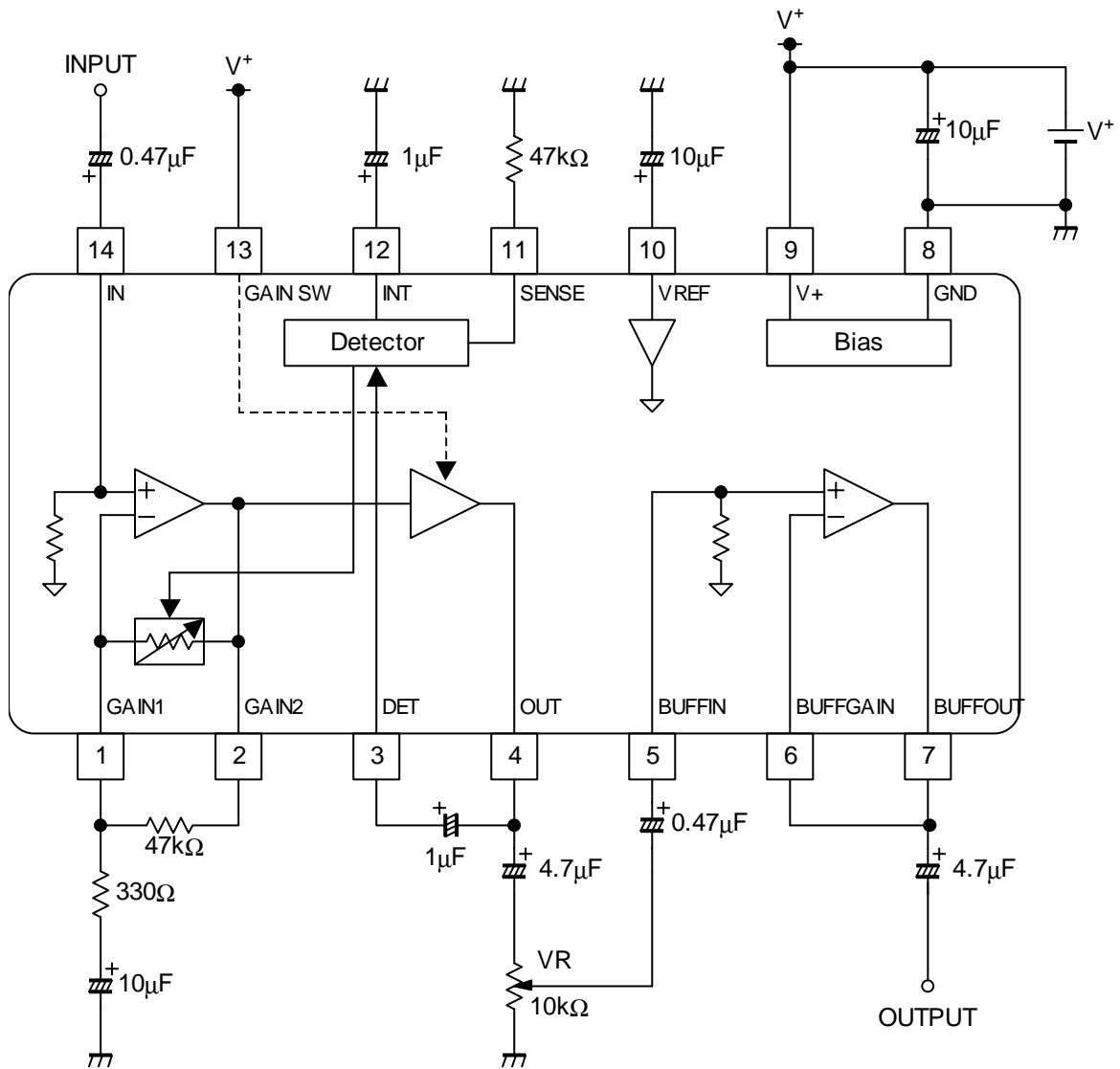

NJM2783

■ TERMINAL DESCRIPTION

PIN NO.	SYMBOL	FUNCTION	EQUIVALENT CIRCUIT	TERMINAL DC VOLTAGE
1	GAIN1	Microphone Amp Gain Setting 1		$V^+/2$
2	GAIN2	Microphone Amp Gain Setting 2		$V^+/2$
3	DET	Detector Input		$V^+/2$
4	OUT	Microphone Amp Output		$V^+/2$
5	BUFFIN	Buffer Input		$V^+/2$

■ TERMINAL DESCRIPTION

PIN NO.	SYMBOL	FUNCTION	EQUIVALENT CIRCUIT	TERMINAL DC VOLTAGE
6	BUFFGAIN	Buffer Gain Setting		$V^+/2$
7	BUFFOUT	Buffer Output		$V^+/2$
10	VREF	Reference Voltage		$V^+/2$
11	SENSE	Limit Level Setting		0V
12	INT	Recovery Time Setting		0V

NJM2783

■ TERMINAL DESCRIPTION

PIN NO.	SYMBOL	FUNCTION	EQUIVALENT CIRCUIT	TERMINAL DC VOLTAGE
13	GAIN SW	Gain Setting		0V
14	IN	Microphone Input		0V

TYPICAL CHARACTERISTICS

Supply Current vs. Supply Voltage

No Signal, $R_{SENSE}=OPEN$, GAIN SW=+20dB

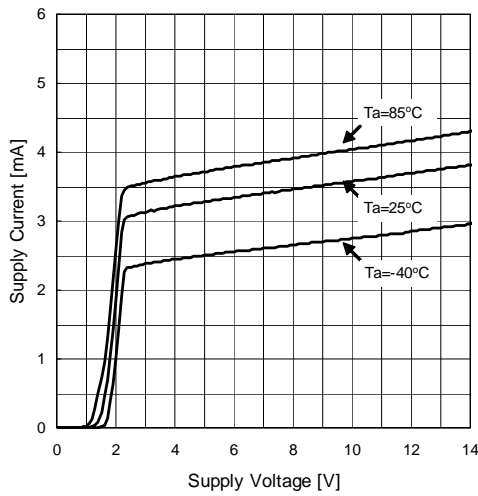

Supply Current vs. Temperature

No Signal, $R_{SENSE}=OPEN$, GAIN SW=+20dB

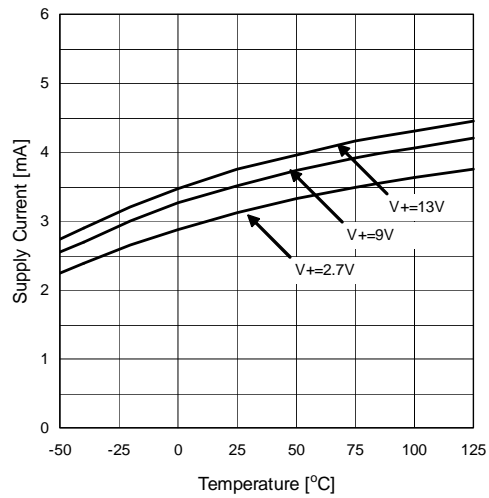

Reference Voltage vs. Supply Voltage

No Signal, $R_{SENSE}=OPEN$, GAIN SW=+20dB

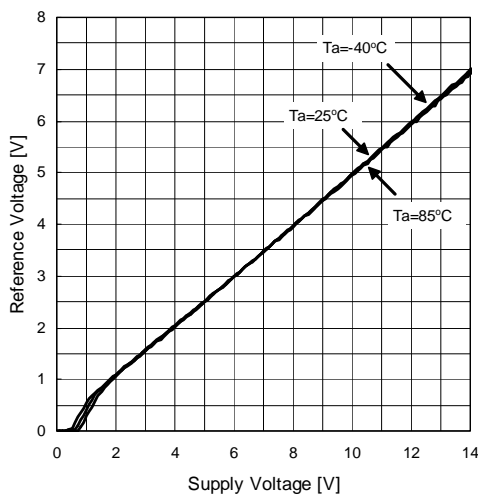

Reference Voltage vs. Temperature

No Signal, $R_{SENSE}=OPEN$, GAIN SW=+20dB

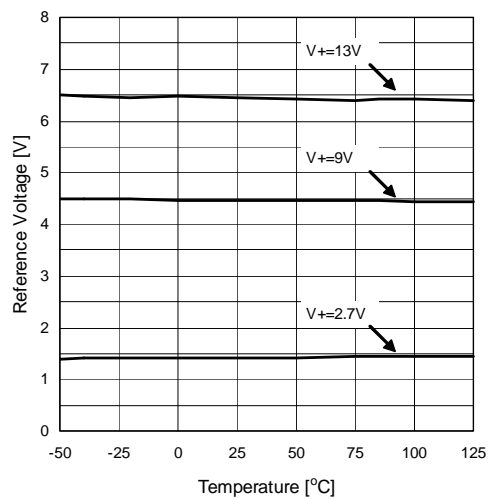

Voltage Gain vs. Frequency

$V^+=9V$, $V_{in}=0.7mVrms$, $R_{G1}=330\Omega$, $R_{G2}=47k\Omega$
 $R_{SENSE}=OPEN$, GAIN SW=+20dB

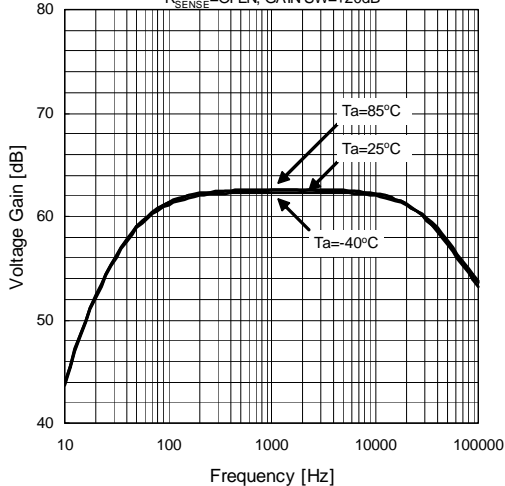

Voltage Gain vs. Frequency

$V^+=9V$, $V_{in}=10mVrms$, $R1=1k\Omega$, $R2=47k\Omega$
GAIN SW=0dB

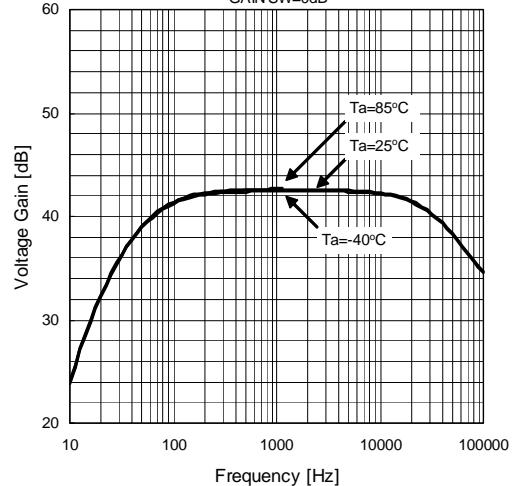

TYPICAL CHARACTERISTICS

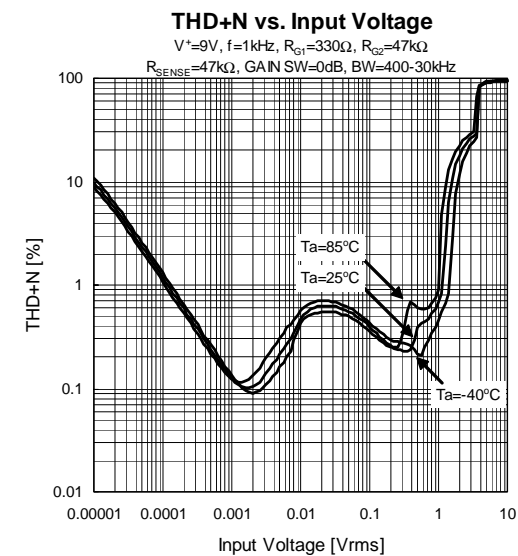
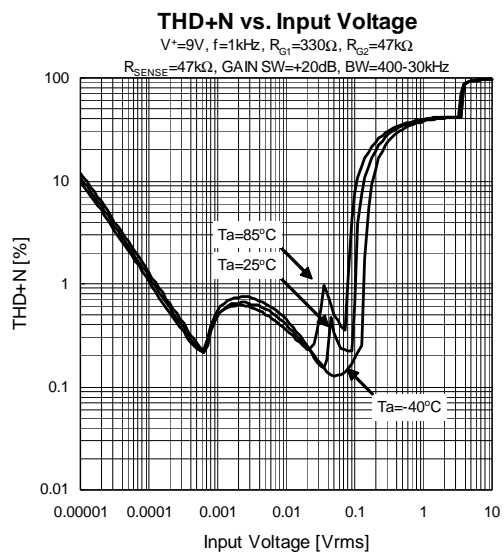
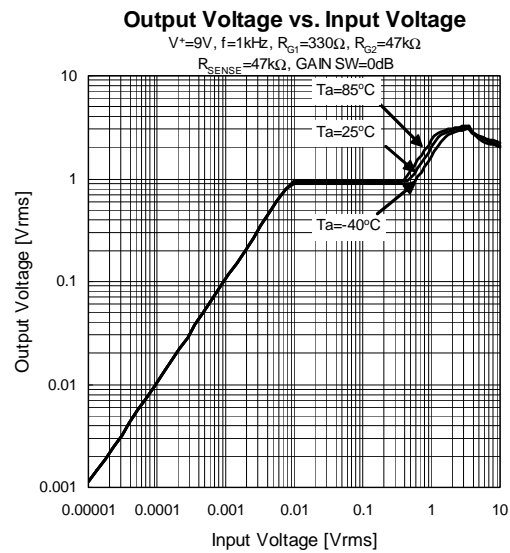
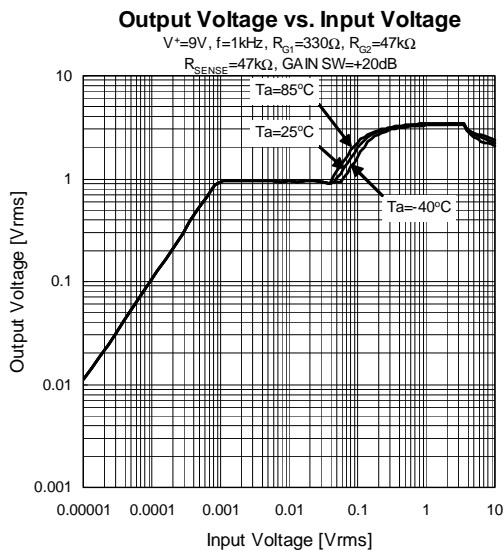
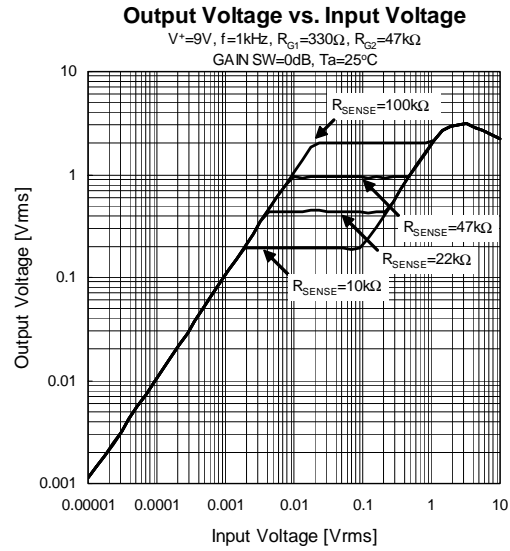
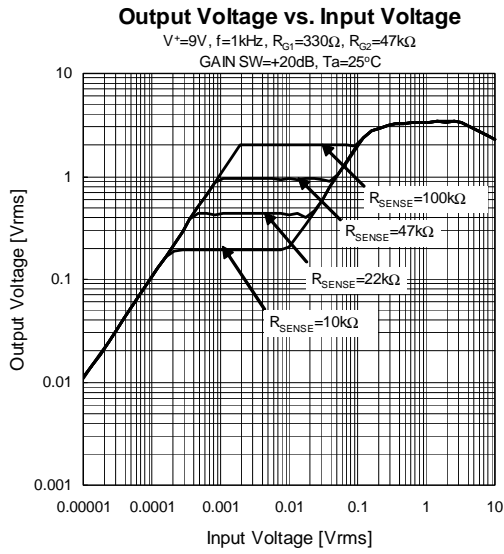

■ TYPICAL CHARACTERISTICS

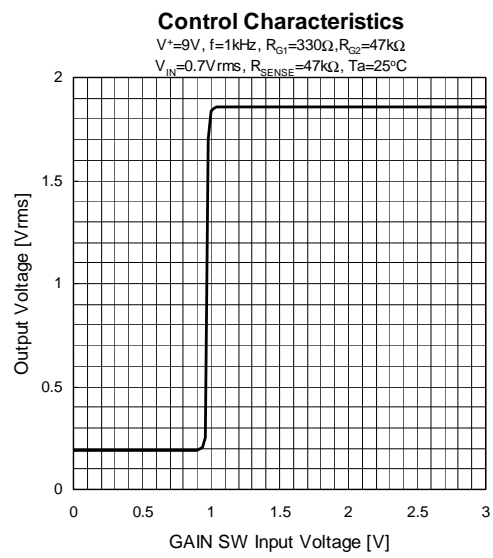
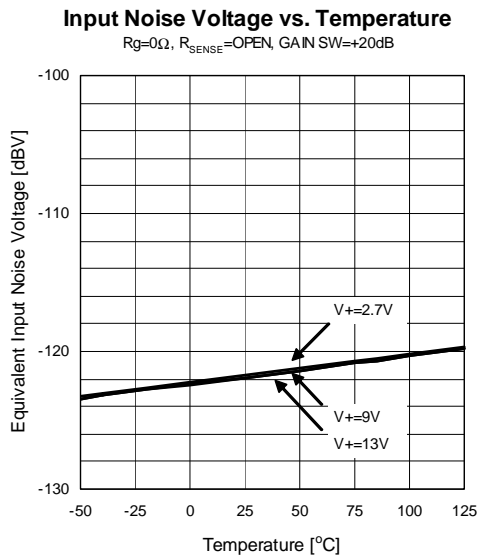
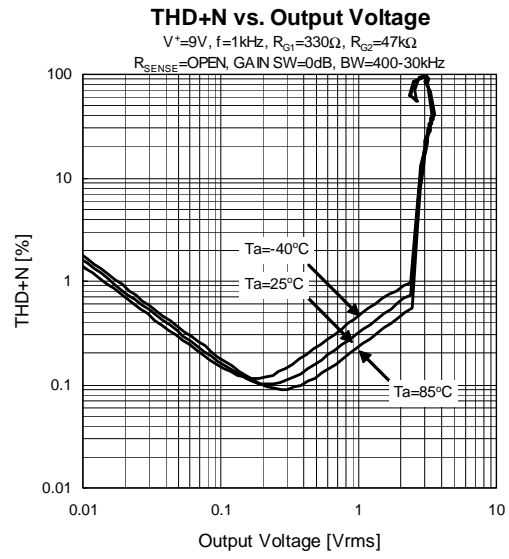
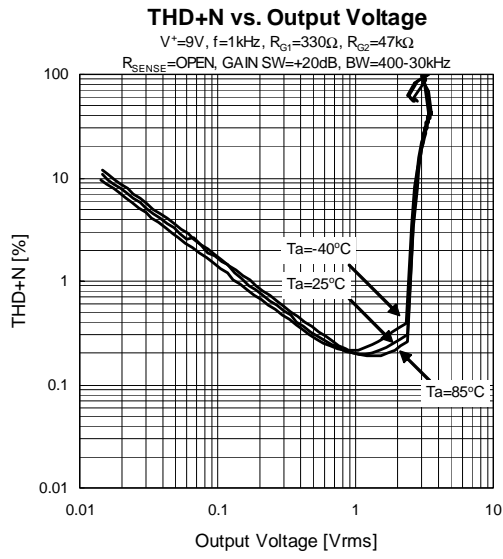

■ TYPICAL CHARACTERISTICS

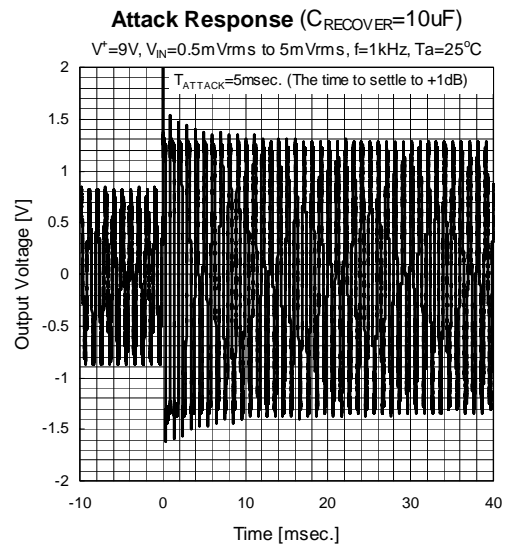
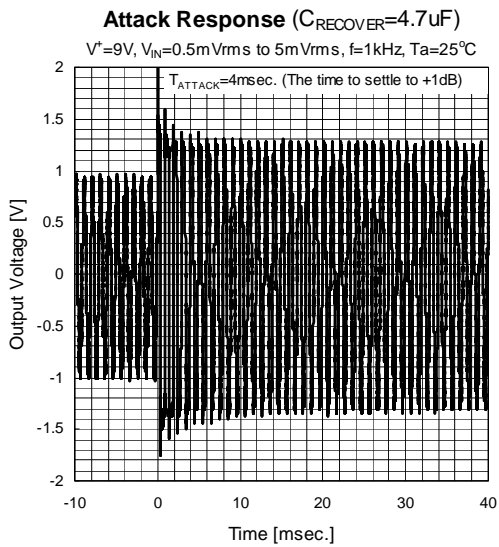
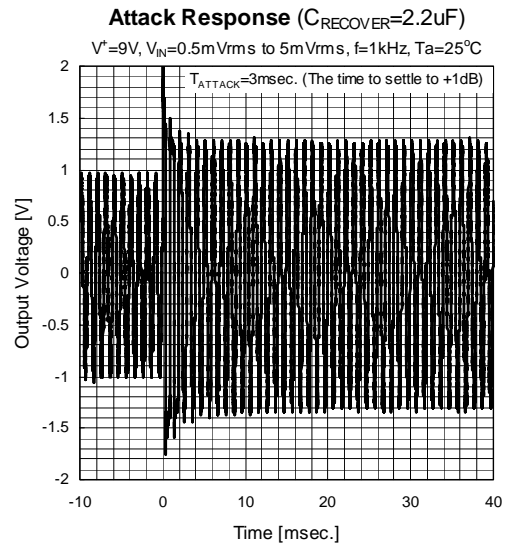
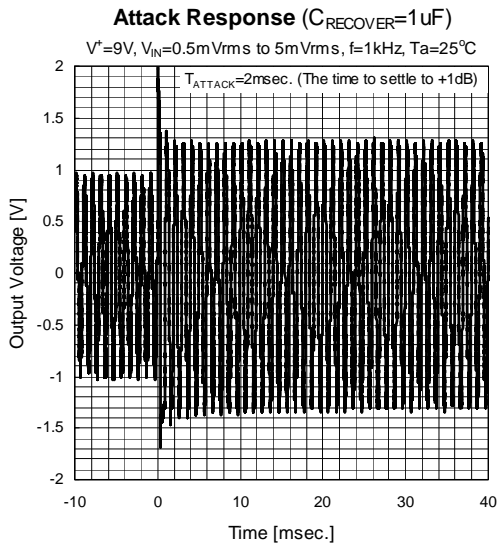

■ TYPICAL CHARACTERISTICS

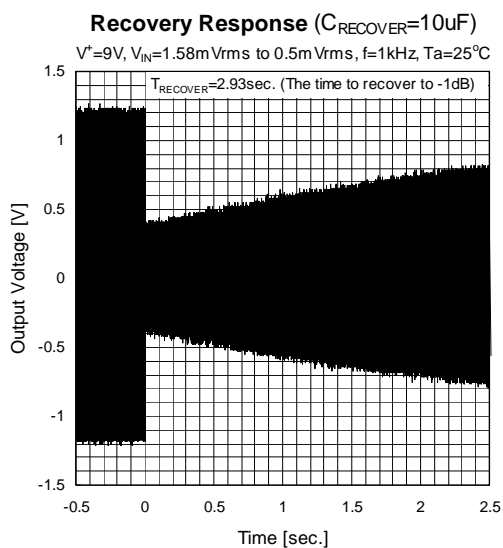
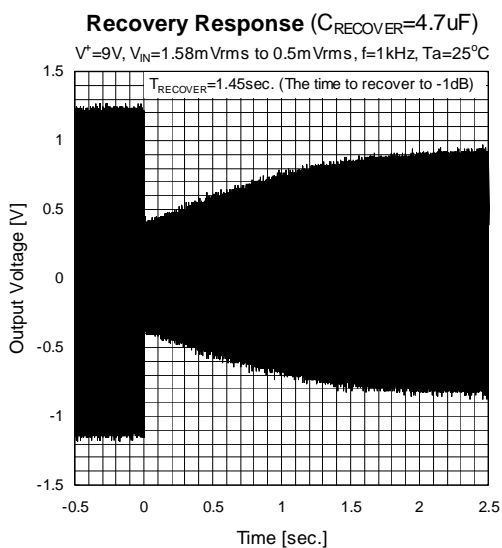
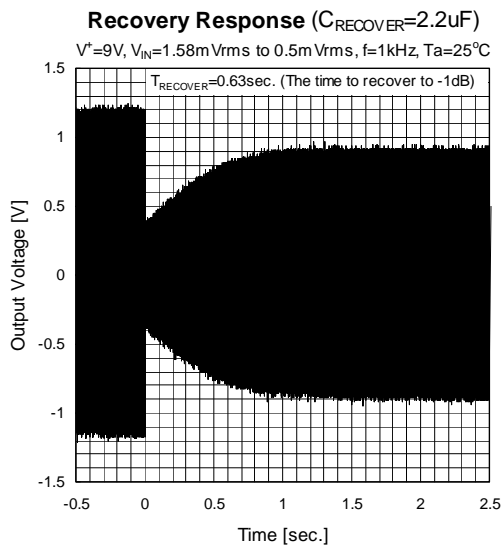
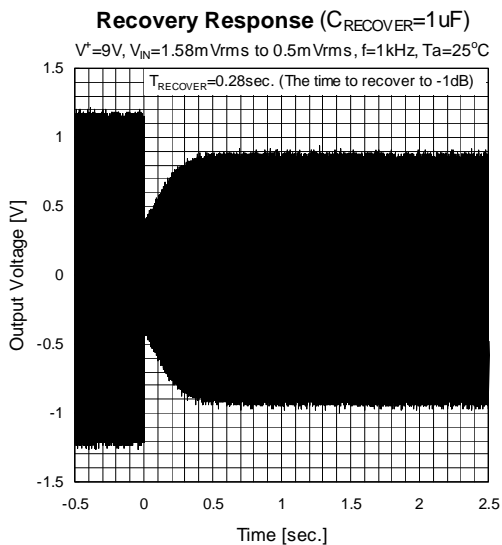



[CAUTION]

The specifications on this databook are only given for information, without any guarantee as regards either mistakes or omissions. The application circuits in this databook are described only to show representative usages of the product and not intended for the guarantee or permission of any right including the industrial rights.

Looking for pricing, stock, or lifecycle information?

Click below to explore more details on WIN SOURCE:

-  [View NJM2783V-TE1 on WIN SOURCE](#)
-  [NJR Corporation/NJRC Information](#)

Optimize Your Supply Chain with WIN SOURCE Solutions

-  Global Sourcing Solution
-  Obsolete Management
-  Cost Control Management
-  Shortage Management
-  Alternative Solution
-  Excess Inventory Management