



**THE DATASHEET OF
CPDT6-5V0UPC-HF**



CPDT6-5V0UPC-HF

RoHS Device
Halogen Free

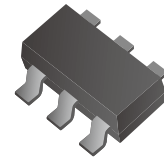

Features

- ESD Protect for 4 high-speed I/O channels.
- IEC61000-4-2(ESD); $\pm 30\text{KV}$ (contact)
- Working voltage: 5V
- Low capacitance: 2.2pF(Typ.).
- High component density.

Mechanical data

- Case: SOT-23-6 standard package, molded plastic.
- Terminals: Solder plated, solderable per MIL-STD-750, method 2026.
- Mounting position: Any
- Weight: 0.015 grams(approx.).

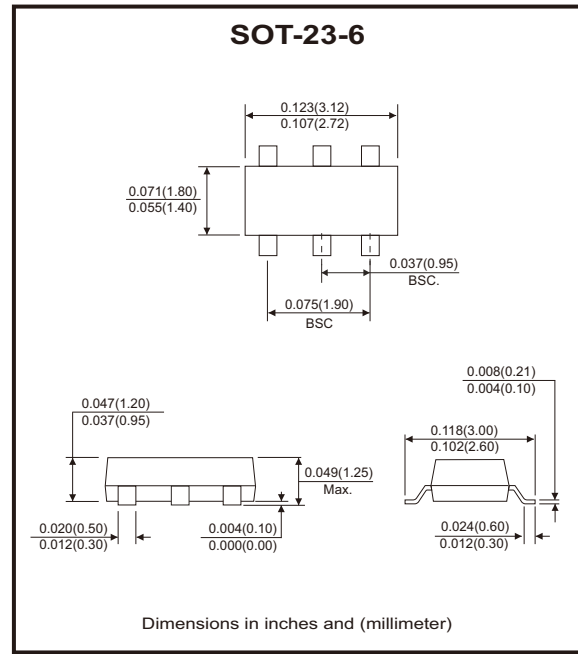

Circuit Diagram

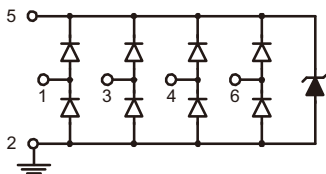

Pin Configuration

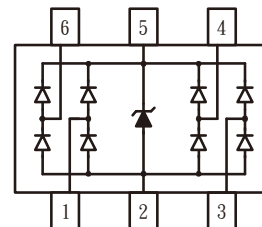

Maximum Ratings (at TA=25°C unless otherwise noted)

Parameter	Symbol	Value	Unit
Peak pulse power (tp = 8/20 us)	PPk	125	W
Peak pulse current (tp = 8/20 us)	IPP	10	A
ESD per IEC 61000-4-2(Air) ESD per IEC 61000-4-2(Contact)	VESD_I/O	± 30	kV
ESD per IEC 61000-4-2(Air)(VCC-GND) ESD per IEC 61000-4-2(Contact)(VCC-GND)	VESD_VCC	± 30	kV
Lead soldering temperature	TSOL	260 (10 sec)	°C
Operating temperature range	Tj	-40 to +125	°C
Storage temperature range	TSTG	-55 to +150	°C
I/O voltage tolerance	V _{I/O}	-0.6 to V _{CC} + 0.6	V

Electrical Characteristics (at TA=25°C unless otherwise noted)

Parameter	Conditions	Symbol	Min	Typ	Max	Unit
Reverse stand-Off voltage		V_{RWM}			5	V
Reverse leakage current	$V_{RWM} = 5\text{ V}$, I/O to GND & V_{CC} to GND	I_R			1	μA
Reverse breakdown voltage	$I_T = 1\text{ mA}$	V_{BR}	6		9	V
Forward voltage	$I_F = 10\text{ mA}$	V_F		0.8	1	V
Clamping voltage	$I_{PP} = 1\text{ A}$, $t_p=8/20\mu\text{s}$, I/O to GND & V_{CC} to GND	V_C		8.6	9.8	V
	$I_{PP} = 10\text{ A}$, $t_p=8/20\mu\text{s}$, I/O to GND & V_{CC} to GND			11.3	12.5	
Junction capacitance	Any I/O to GND $V_R = 0\text{V}$, $f = 1\text{MHz}$	C_j		2.2	4	pF
	I/O to I/O $V_R = 0\text{V}$, $f = 1\text{MHz}$				2	

RATING AND CHARACTERISTIC CURVES (CPDT6-5V0UPC-HF)

Fig.1 - 8/20us Peak Pulse Current
Wave Form Acc. IEC 61000-4-5

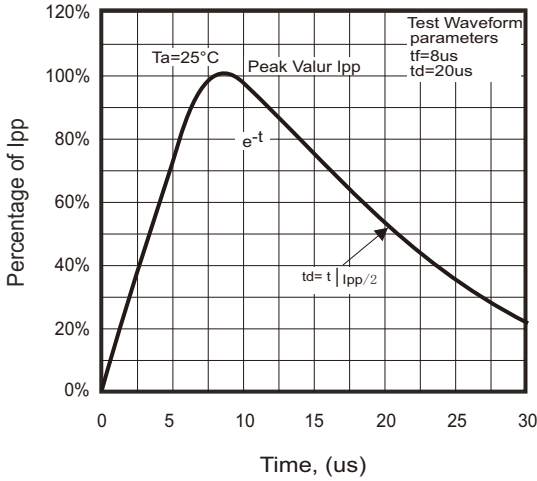

Fig.2 - Power Derating Curve

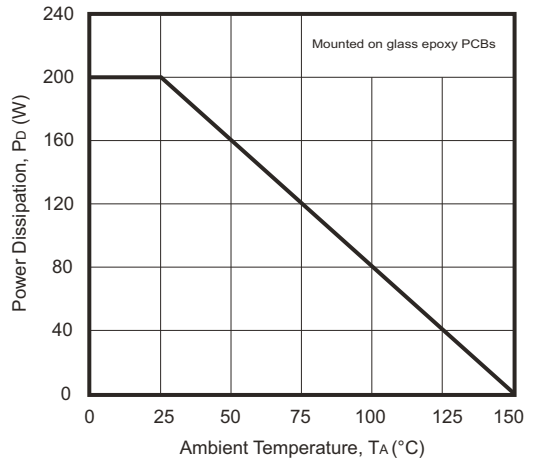

Fig.3 - Forward Characteristic

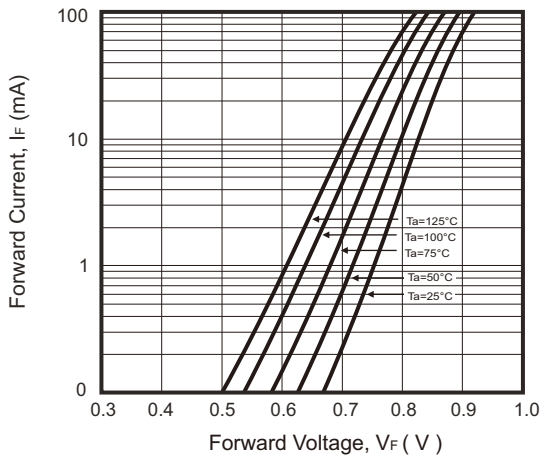

Fig.4 - Clamping Voltage Vs. Peak Pulse Current

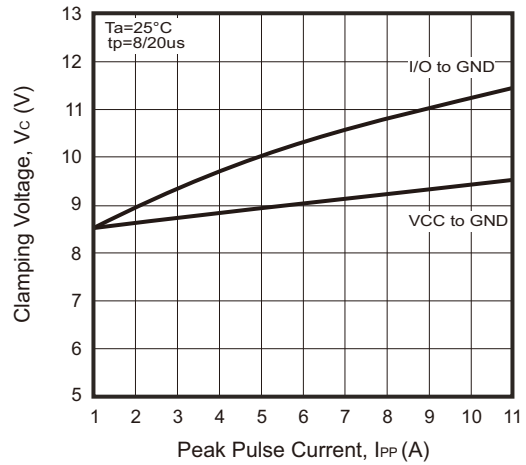
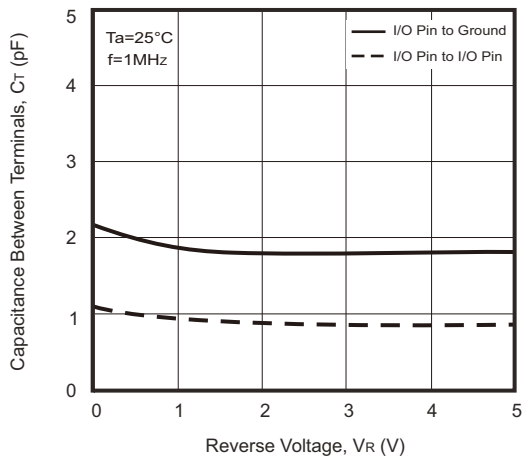
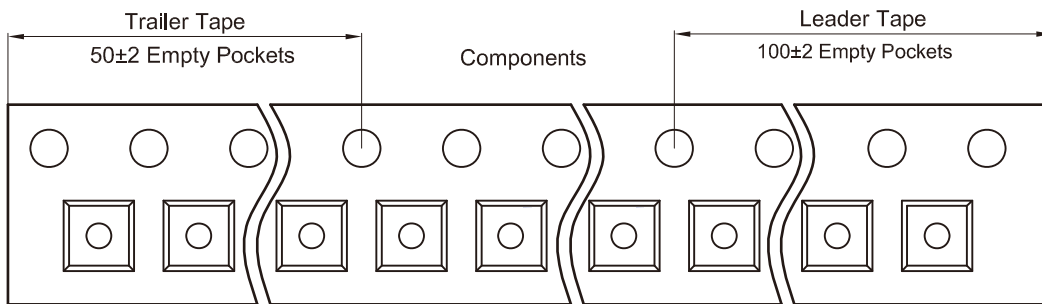
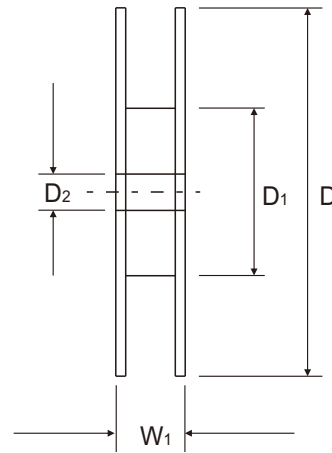
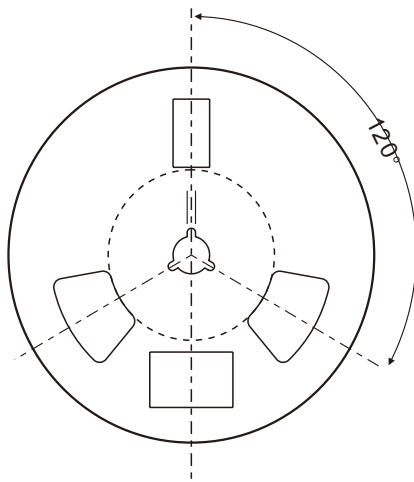
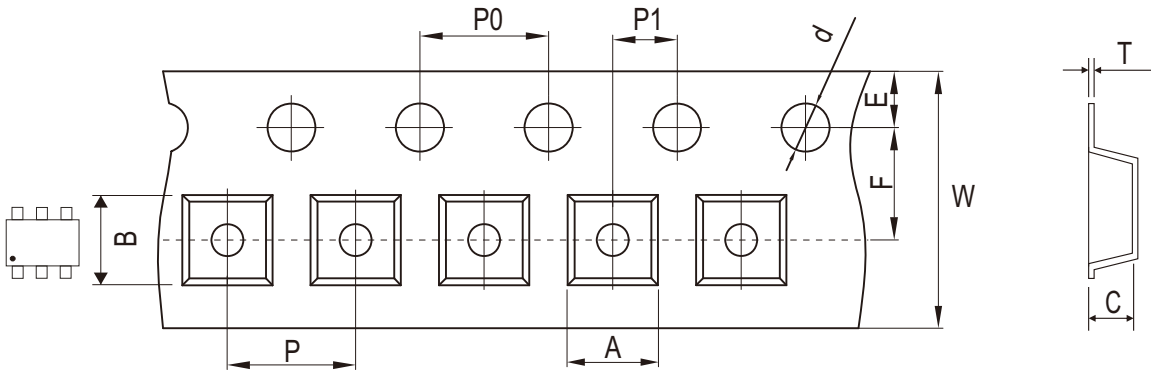

Fig.5 - Capacitance Characteristics



Reel Taping Specification



SOT-23-6	SYMBOL	A	B	C	d	D	D ₁	D ₂
	(mm)	3.26 ± 0.10	3.30 ± 0.10	1.40 ± 0.10	1.55 + 0.10 - 0.00	180.00 ± 1.00	54.40 + 1.00 - 0.00	13.00 + 0.50 - 0.20
	(inch)	0.128 ± 0.004	0.130 ± 0.004	0.055 ± 0.004	0.061 + 0.004 - 0.000	7.087 ± 0.039	20142 + 0.039 - 0.000	0.512 + 0.020 - 0.008

SOT-23-6	SYMBOL	E	F	P	P ₀	P ₁	W	W ₁
	(mm)	1.75 ± 0.10	3.50 ± 0.05	4.00 ± 0.10	4.00 ± 0.10	2.00 ± 0.05	8.00 ± 0.10	12.00 + 1.00 - 0.30
	(inch)	0.069 ± 0.004	0.138 ± 0.002	0.157 ± 0.004	0.157 ± 0.004	0.079 ± 0.002	0.315 ± 0.004	0.472 + 0.039 - 0.012

Marking Code

Part Number	Marking Code
CPDT6-5V0UPC-HF	.E5UP

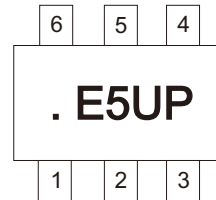

Suggested PAD Layout

SIZE	SOT-23-6	
	(mm)	(inch)
A	1.00	0.039
B	0.70	0.028
C	0.95	0.037
D	2.40	0.094
E	3.40	0.134

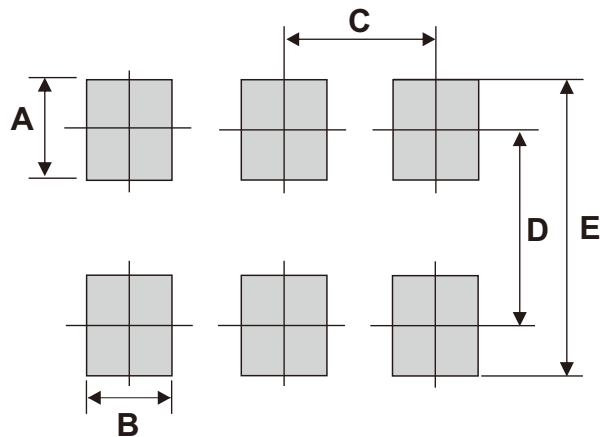

Standard Packaging

Case Type	REEL PACK	
	REEL (pcs)	Reel Size (inch)
SOT-23-6	3,000	7

Looking for pricing, stock, or lifecycle information?

Click below to explore more details on WIN SOURCE:

- [View CPDT6-5V0UPC-HF on WIN SOURCE](#)
- [Comchip Technology Information](#)

Optimize Your Supply Chain with WIN SOURCE Solutions

- ✓ Global Sourcing Solution
- ✓ Obsolete Management
- ✓ Cost Control Management
- ✓ Shortage Management
- ✓ Alternative Solution
- ✓ Excess Inventory Management