

HiPerFAST™ IGBT with Diode

IXGH 32N60CD1
IXGT 32N60CD1

$V_{CES} = 600 \text{ V}$
 $I_{C25} = 60 \text{ A}$
 $V_{CE(SAT)typ} = 2.1 \text{ V}$
 $t_{fi(typ)} = 55 \text{ ns}$

Light Speed Series

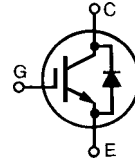

Symbol	Test Conditions	Maximum Ratings	
V_{CES}	$T_J = 25^\circ\text{C to } 150^\circ\text{C}$	600	V
V_{CGR}	$T_J = 25^\circ\text{C to } 150^\circ\text{C}; R_{GE} = 1 \text{ M}\Omega$	600	V
V_{GES}	Continuous	± 20	V
V_{GEM}	Transient	± 30	V
I_{C25}	$T_C = 25^\circ\text{C}$	60	A
I_{C90}	$T_C = 90^\circ\text{C}$	32	A
I_{CM}	$T_C = 25^\circ\text{C}, 1 \text{ ms}$	120	A
SSOA (RBSOA)	$V_{GE} = 15 \text{ V}, T_{VJ} = 125^\circ\text{C}, R_G = 10 \Omega$ Clamped inductive load @ $0.8 V_{CES}$	$I_{CM} = 64$	A
P_C	$T_C = 25^\circ\text{C}$	200	W
T_J		-55 ... +150	$^\circ\text{C}$
T_{JM}		150	$^\circ\text{C}$
T_{stg}		-55 ... +150	$^\circ\text{C}$
Maximum Lead and Tab temperature for soldering 1.6 mm (0.062 in.) from case for 10 s		300	$^\circ\text{C}$
M_d	Mounting torque, TO-247 AD	1.13/10	Nm/lb.in.
Weight	TO-247 AD	6	g
	TO-268	5	g

TO-247 AD (IXGH)

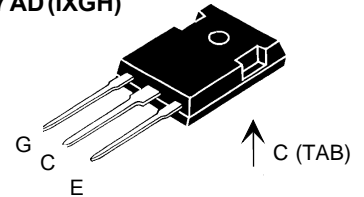

TO-268 (D3) (IXGT)

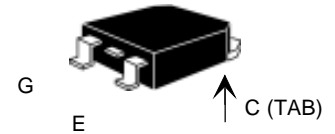

G = Gate C = Collector
E = Emitter

Features

- International standard TO-247AD package
- High current handling capability
- Latest generation HDMOS™ process
- MOS Gate turn-on - drive simplicity

Applications

- Uninterruptible power supplies (UPS)
- Switched-mode and resonant-mode power supplies
- AC motor speed control
- DC servo and robot drives
- DC choppers

Advantages

- High power density
- Very fast switching speeds for high frequency applications
- High power surface mountable package

Symbol	Test Conditions	Characteristic Values ($T_J = 25^\circ\text{C}$, unless otherwise specified)		
		min.	typ.	max.
BV_{CES}	$I_C = 250 \mu\text{A}, V_{GE} = 0 \text{ V}$	600		V
$V_{GE(th)}$	$I_C = 250 \mu\text{A}, V_{CE} = V_{GE}$	2.5		5.0 V
I_{CES}	$V_{CE} = 0.8 \cdot V_{CES}$ $V_{GE} = 0 \text{ V}$	$T_J = 25^\circ\text{C}$		200 μA
		$T_J = 125^\circ\text{C}$		3 mA
I_{GES}	$V_{CE} = 0 \text{ V}, V_{GE} = \pm 20 \text{ V}$			$\pm 100 \text{ nA}$
$V_{CE(sat)}$	$I_C = I_{C90}, V_{GE} = 15 \text{ V}$	2.1	2.5	V

Symbol	Test Conditions	Characteristic Values		
		(T _J = 25°C, unless otherwise specified)		
		min.	typ.	max.
g_{fs}	I _C = I _{C90} ; V _{CE} = 10 V, Pulse test, t ≤ 300 μs, duty cycle ≤ 2 %		25	S
C_{ies}	V _{CE} = 25 V, V _{GE} = 0 V, f = 1 MHz		2700	pF
C_{oes}			240	pF
C_{res}			50	pF
Q_g	I _C = I _{C90} ; V _{GE} = 15 V, V _{CE} = 0.5 V _{CES}		110	nC
Q_{ge}			22	nC
Q_{gc}			40	nC
t_{d(on)}	Inductive load, T_J = 25°C I _C = I _{C90} ; V _{GE} = 15 V V _{CE} = 0.8 V _{CES} ; R _G = R _{off} = 4.7 Ω Remarks: Switching times may increase for V _{CE} (Clamp) > 0.8 • V _{CES} , higher T _J or increased R _G		25	ns
t_{ri}			20	ns
t_{d(off)}			85	ns
t_{fi}			55	ns
E_{off}			0.32	mJ
t_{d(on)}	Inductive load, T_J = 125°C I _C = I _{C90} ; V _{GE} = 15 V V _{CE} = 0.8 V _{CES} ; R _G = R _{off} = 4.7 Ω Remarks: Switching times may increase for V _{CE} (Clamp) > 0.8 • V _{CES} , higher T _J or increased R _G		25	ns
t_{ri}			25	ns
E_{on}			1	mJ
t_{d(off)}			110	170 ns
t_{fi}			100	160 ns
E_{off}		0.85	1.25 mJ	
R_{thJC}				0.62 K/W
R_{thCK}		0.25		K/W

Symbol	Test Conditions	Characteristic Values		
		(T _J = 25°C, unless otherwise specified)		
		min.	typ.	max.
V_F	I _F = I _{C90} ; V _{GE} = 0 V, Pulse test t ≤ 300 μs, duty cycle d ≤ 2 %	T _J = 150°C		1.6 V
		T _J = 25°C		2.5 V
I_{RM}	I _F = I _{C90} ; V _{GE} = 0 V, -di _F /dt = 100 A/μs V _R = 100 V I _F = 1 A; -di _F /dt = 100 A/μs; V _R = 30 V	T _J = 100°C	6	A
t_{rr}		T _J = 25°C	100	ns
			25	ns
R_{thJC}				0.9 K/W

TO-247 AD Outline

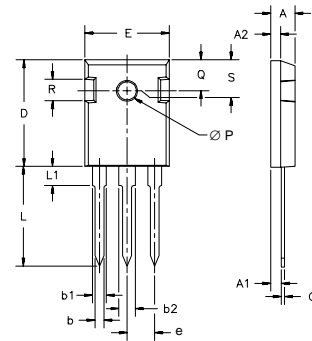

Dim.	Millimeter		Inches	
	Min.	Max.	Min.	Max.
A	4.7	5.3	.185	.209
A ₁	2.2	2.54	.087	.102
A ₂	2.2	2.6	.059	.098
b	1.0	1.4	.040	.055
b ₁	1.65	2.13	.065	.084
b ₂	2.87	3.12	.113	.123
C	.4	.8	.016	.031
D	20.80	21.46	.819	.845
E	15.75	16.26	.610	.640
e	5.20	5.72	0.205	0.225
L	19.81	20.32	.780	.800
L ₁		4.50		.177
ØP	3.55	3.65	.140	.144
Q	5.89	6.40	0.232	0.252
R	4.32	5.49	.170	.216
S	6.15	BSC	.242	BSC

TO-268 Outline

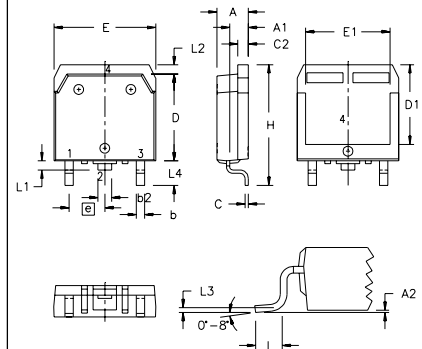

Terminals: 1 - Gate 2 - Collector
3 - Emitter

SYM	INCHES		MILLIMETERS	
	MIN	MAX	MIN	MAX
A	.193	.201	4.90	5.10
A ₁	.106	.114	2.70	2.90
A ₂	.001	.010	0.02	0.25
b	.045	.057	1.15	1.45
b ₂	.075	.083	1.90	2.10
C	.016	.026	0.40	0.65
C ₂	.057	.063	1.45	1.60
D	5.43	5.51	13.80	14.00
D ₁	4.88	5.00	12.40	12.70
E	.624	.632	15.85	16.05
E ₁	5.24	5.35	13.30	13.60
e	.215 BSC		5.45 BSC	
H	.736	.752	18.70	19.10
L	.094	.106	2.40	2.70
L ₁	.047	.055	1.20	1.40
L ₂	.039	.045	1.00	1.15
L ₃	.010 BSC		0.25 BSC	
L ₄	.150	.161	3.80	4.10

IXYS reserves the right to change limits, test conditions, and dimensions.

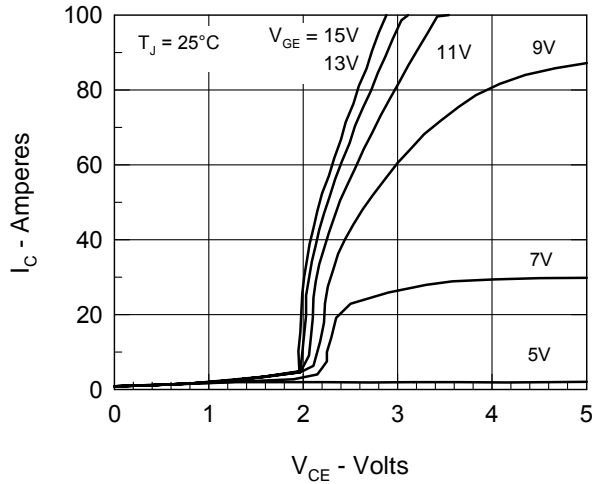

Fig. 1. Output Characteristics

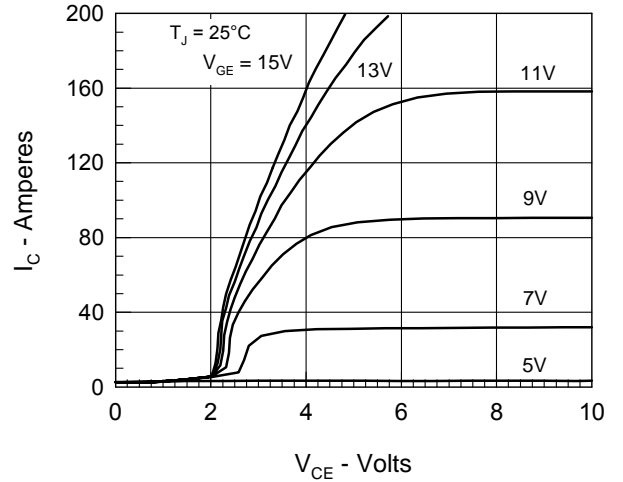

Fig. 2. Extended Output Characteristics

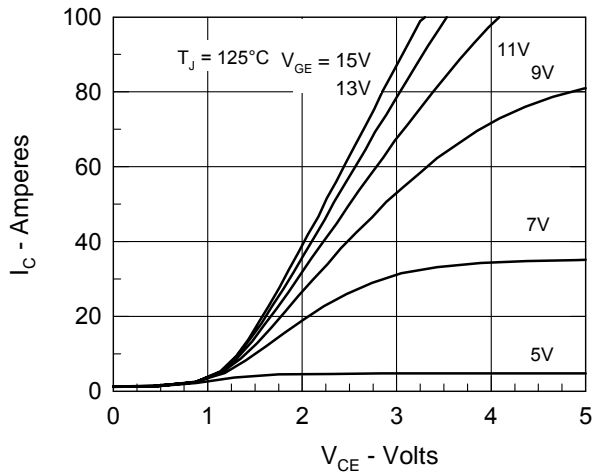

Fig. 3. High Temperature Output Characteristics

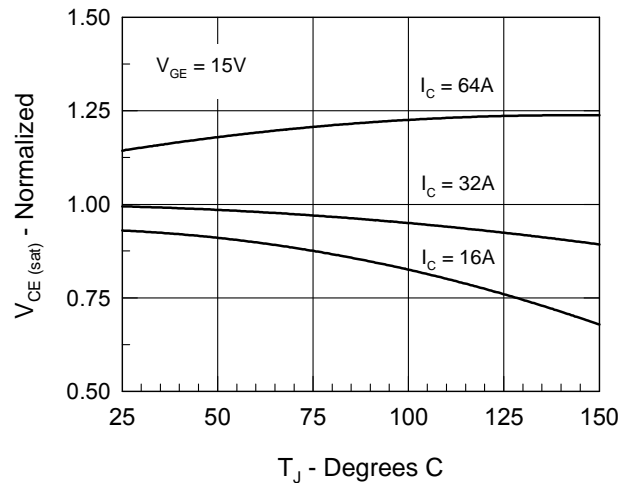
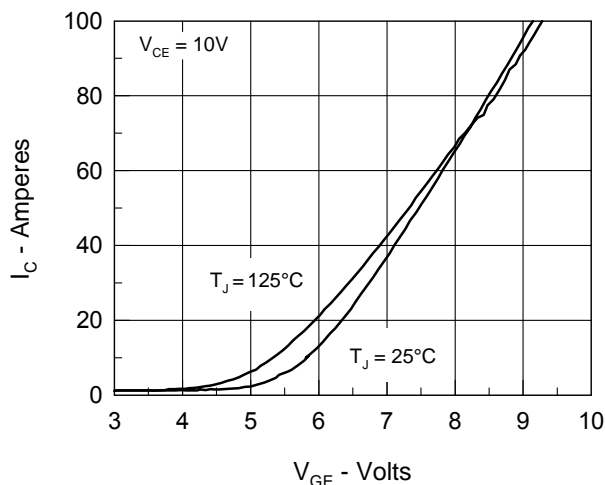

 Fig. 4. Temperature Dependence of $V_{CE(sat)}$

Fig. 5. Admittance Curves

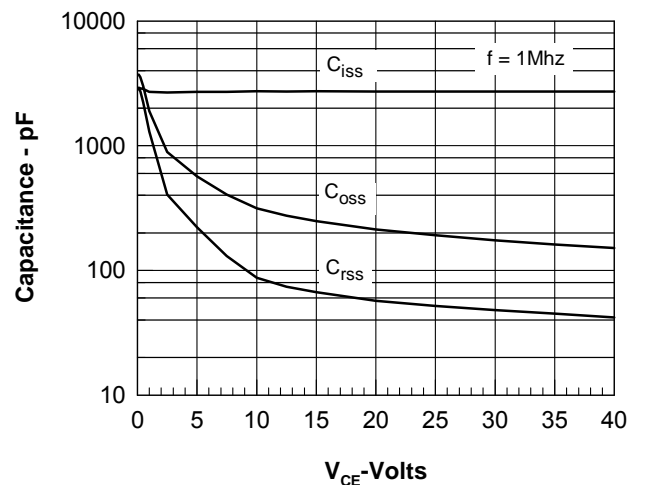

Fig. 6. Capacitance Curves

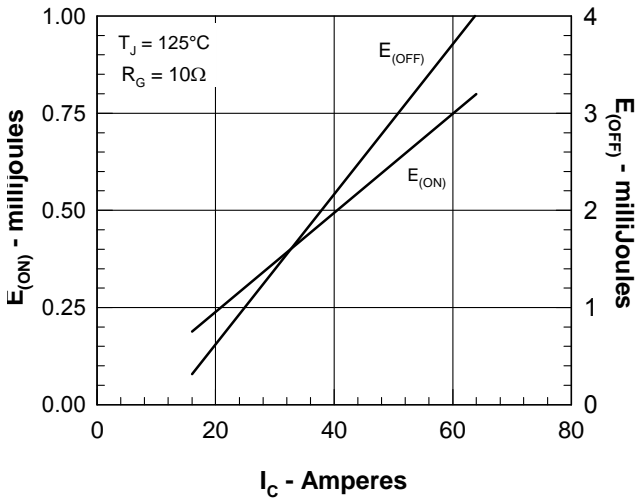

Fig. 7. Dependence of E_{ON} and E_{OFF} on I_C .

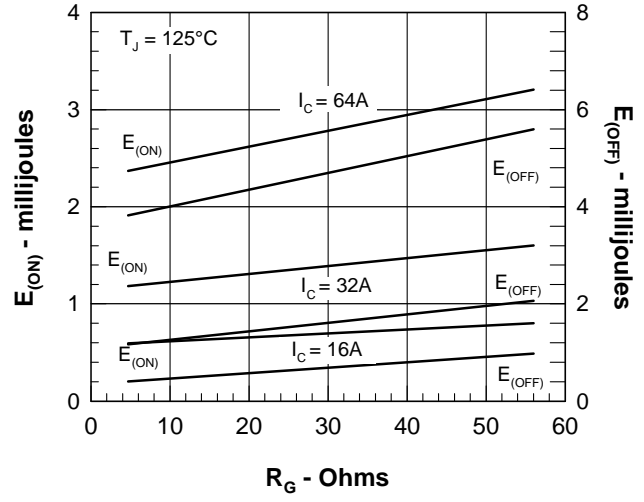

Fig. 8. Dependence of E_{ON} and E_{OFF} on R_G .

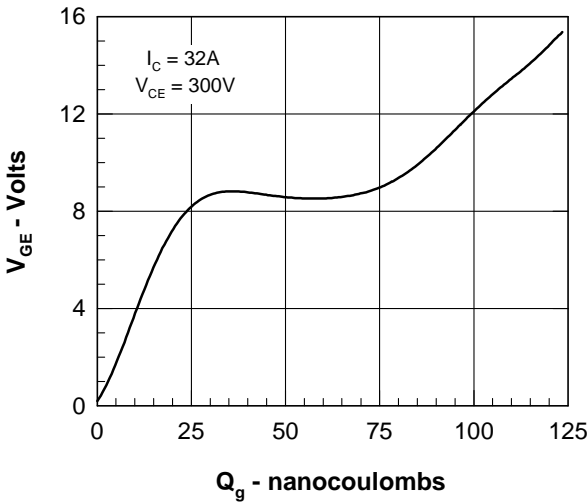

Fig. 9. Gate Charge

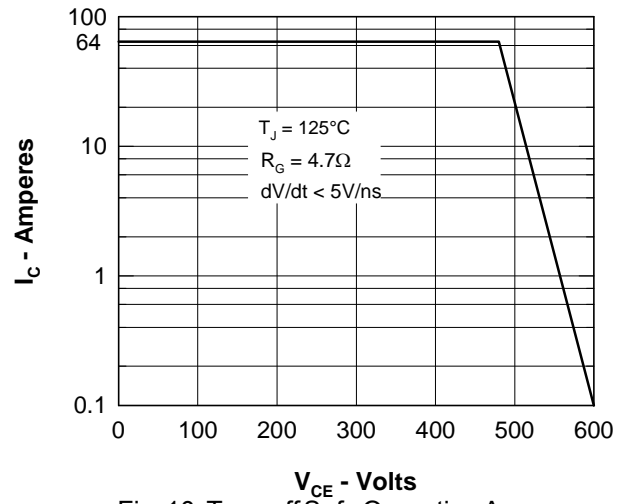

Fig. 10. Turn-off Safe Operating Area

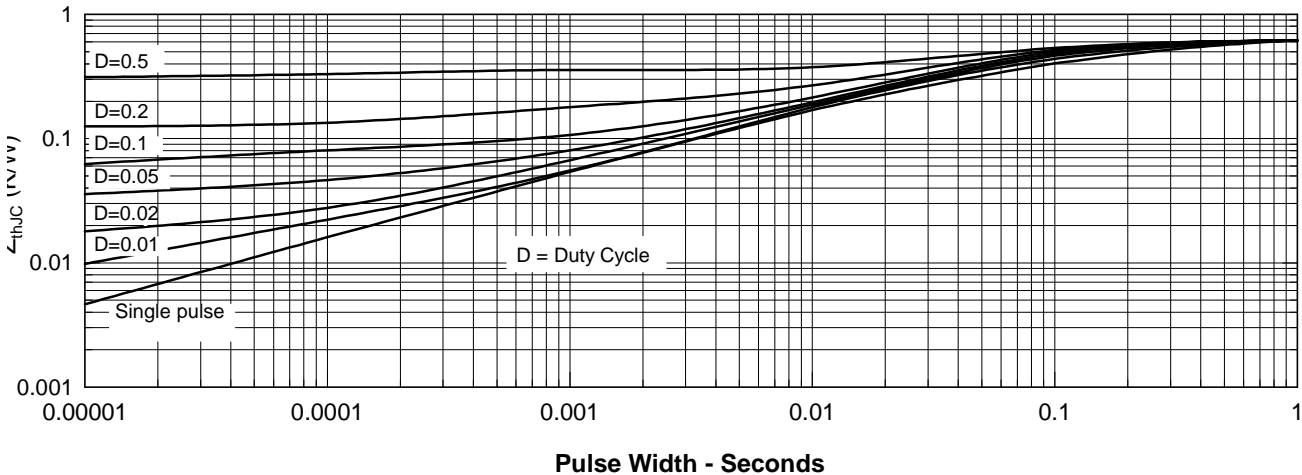

Fig. 11. Transient Thermal Resistance

IXYS reserves the right to change limits, test conditions, and dimensions.

IXYS MOSFETs and IGBTs are covered by one or more of the following U.S. patents:

4,835,592	4,881,106	5,017,508	5,049,961	5,187,117	5,486,715	6,306,728B1
4,850,072	4,931,844	5,034,796	5,063,307	5,237,481	5,381,025	

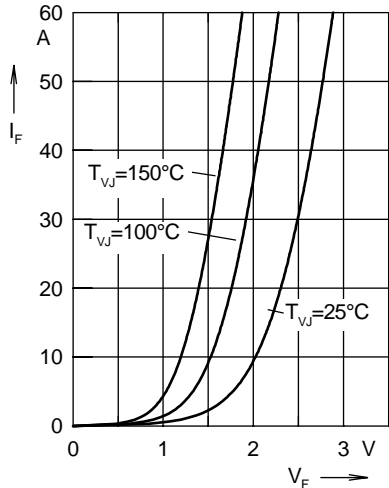

Fig. 12 Forward current I_F versus V_F

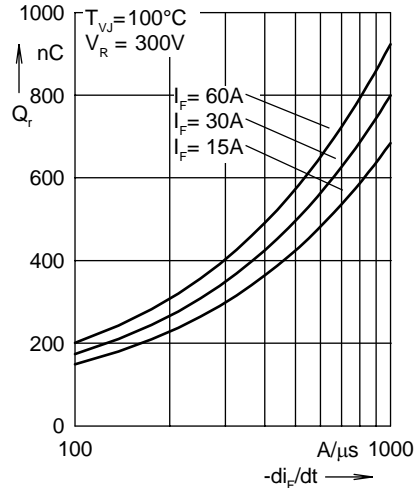

Fig. 13 Reverse recovery charge Q_r versus $-di_F/dt$

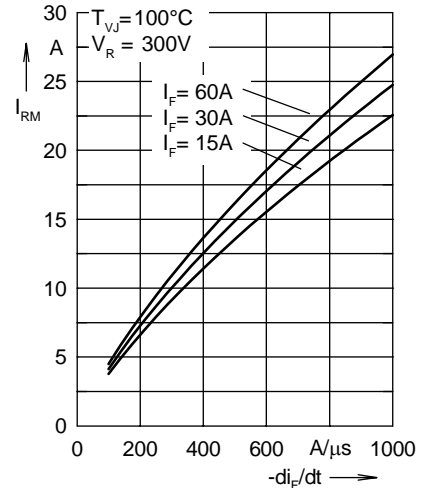

Fig. 14 Peak reverse current I_{RM} versus $-di_F/dt$

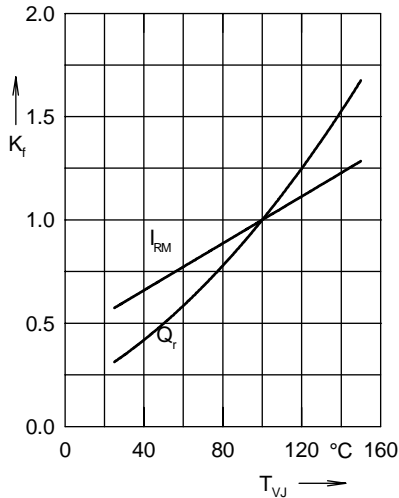

Fig. 15 Dynamic parameters Q_r , I_{RM} versus T_{VJ}

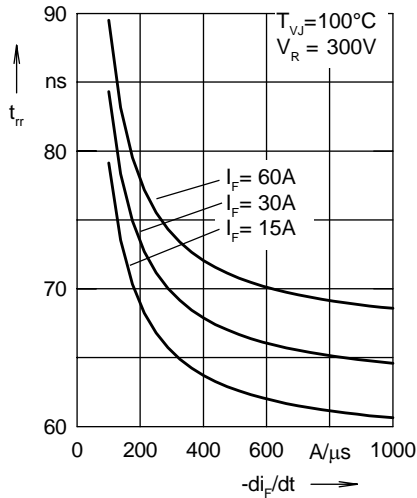

Fig. 16 Recovery time t_{rr} versus $-di_F/dt$

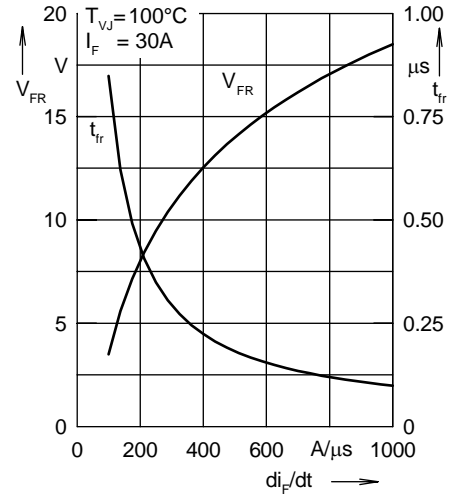

Fig. 17 Peak forward voltage V_{FR} and t_{rr} versus di_F/dt

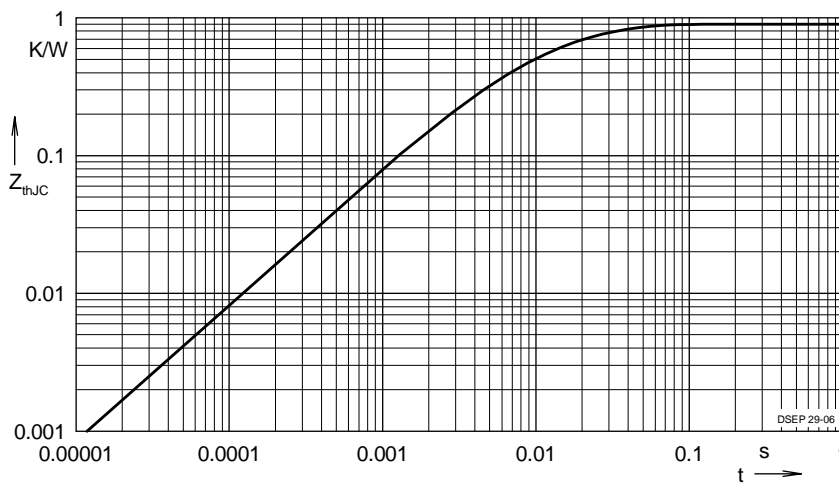

Fig. 18 Transient thermal resistance junction to case

Constants for Z_{thJC} calculation:

i	R_{thi} (K/W)	t_i (s)
1	0.502	0.0052
2	0.193	0.0003
3	0.205	0.0162

Looking for pricing, stock, or lifecycle information?

Click below to explore more details on WIN SOURCE:

 [View IXGH32N60CD1 on WIN SOURCE](#)

 [IXYS Information](#)

Optimize Your Supply Chain with WIN SOURCE Solutions

-  Global Sourcing Solution
-  Obsolete Management
-  Cost Control Management
-  Shortage Management
-  Alternative Solution
-  Excess Inventory Management