



**THE DATASHEET OF
DS1816R-5+T&R**



FEATURES

- Automatically restarts a microprocessor after power failure
- Maintains reset for 150ms after V_{CC} returns to an in-tolerance condition
- Reduces need for discrete components
- Precision temperature-compensated voltage reference and voltage sensor
- Accurate 5%, 10% or 20% power monitoring
- 20% tolerance for use with 3V systems
- Low-cost TO-92 or space saving SOT-23 packages available
- Efficient open-drain output with internal $5k\Omega$ pull-up resistor
- Operating temperature -40°C to $+85^{\circ}\text{C}$

PIN ASSIGNMENT

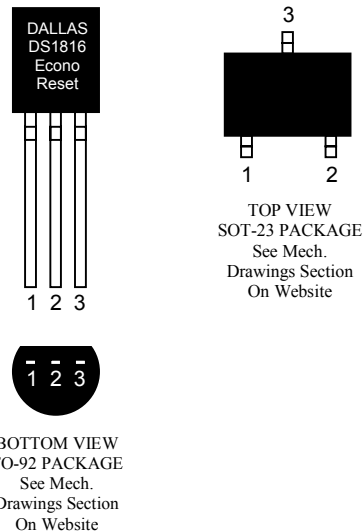

PIN DESCRIPTION

TO-92

1	$\overline{\text{RST}}$	Active Low Reset Output
2	V_{CC}	Power Supply
3	GND	Ground

SOT-23

1	$\overline{\text{RST}}$	Active Low Reset Output
2	V_{CC}	Power Supply
3	GND	Ground

DESCRIPTION

The DS1816 EconoReset uses a precision temperature reference and comparator circuit to monitor the status of the power supply (V_{CC}). When an out-of-tolerance condition is detected, an internal power-fail signal is generated which forces reset to the active state. When V_{CC} returns to an in-tolerance condition, the reset signal is kept in the active state for approximately 150ms to allow the power supply and processor to stabilize.

OPERATION — POWER MONITOR

The DS1816 provides the function of detecting out-of-tolerance power supply conditions and warning a processor-based system of impending power failure. When V_{CC} is detected as out-of-tolerance, the \overline{RST} signal is asserted. On power-up, \overline{RST} is kept active for approximately 150ms after the power supply has reached the selected tolerance. This allows the power supply and microprocessor to stabilize before \overline{RST} is released.

BLOCK DIAGRAM (OPEN-DRAIN OUTPUT) Figure 1

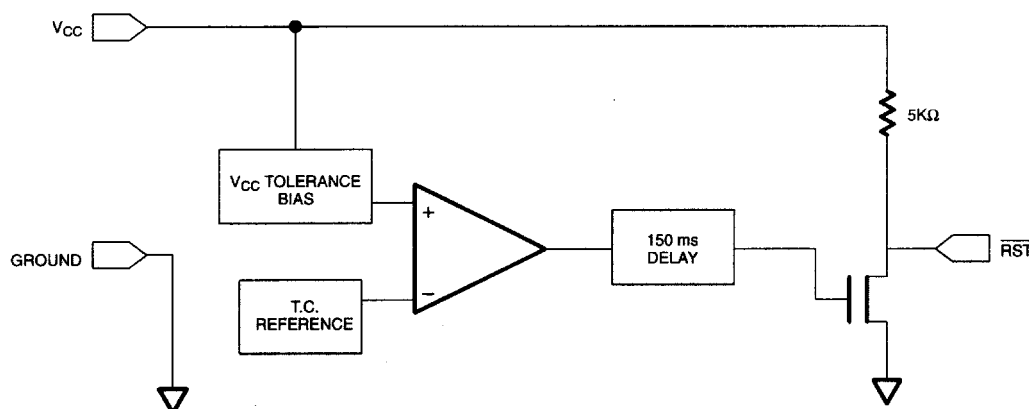

APPLICATION EXAMPLE Figure 2

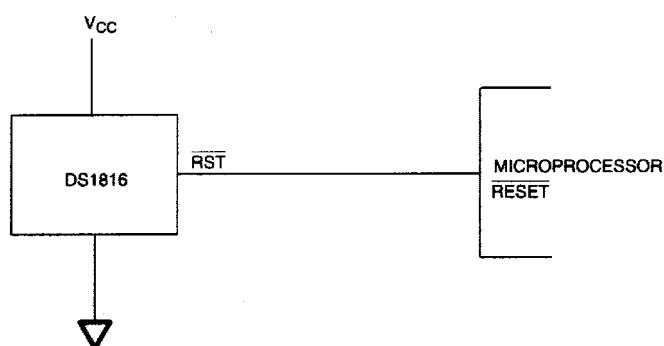

TIMING DIAGRAM: POWER-UP Figure 3

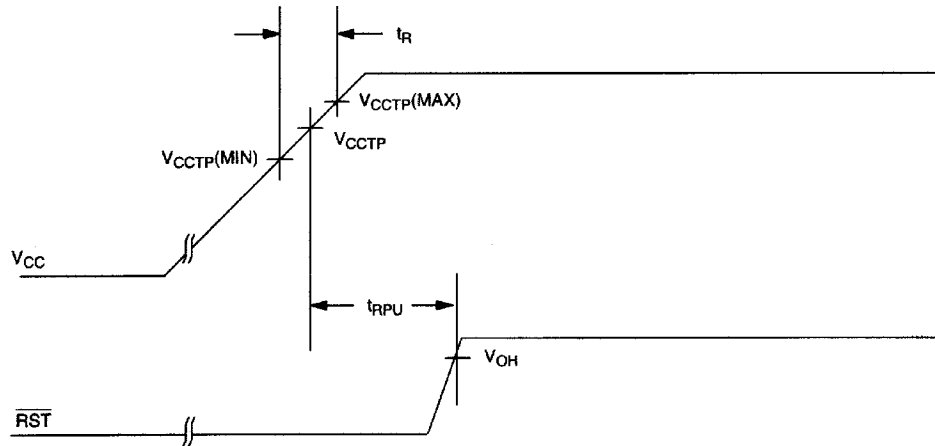

TIMING DIAGRAM: POWER-DOWN Figure 4

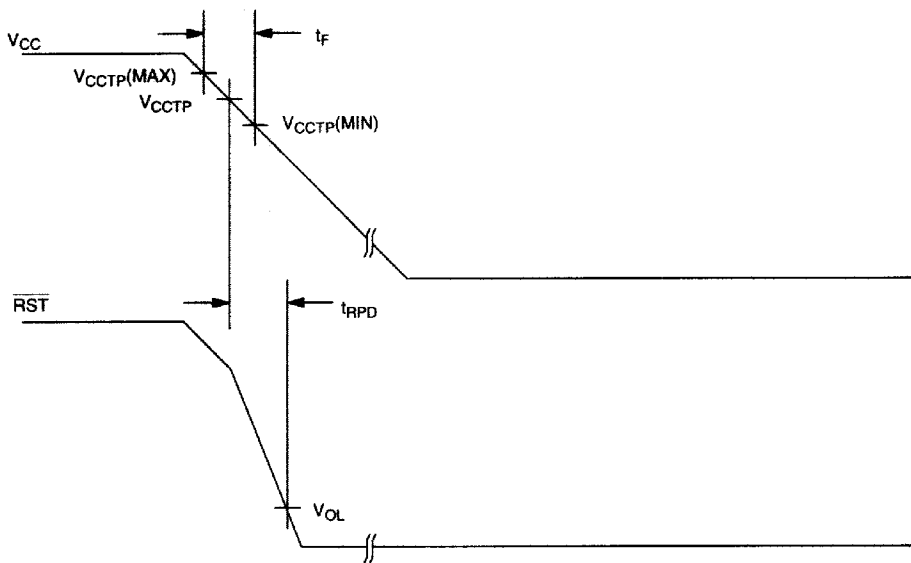

ABSOLUTE MAXIMUM RATINGS*

Voltage on V_{CC} Pin Relative to Ground	-0.5V to +7.0V
Voltage on RST Relative to Ground	-0.5V to $V_{CC} + 0.5V$
Operating Temperature Range	-40°C to +85°C
Storage Temperature Range	-55°C to +125°C
Soldering Temperature	260°C for 10 seconds

* This is a stress rating only and functional operation of the device at these or any other conditions above those indicated in the operation sections of this specification is not implied. Exposure to absolute maximum rating conditions for extended periods of time may affect reliability.

RECOMMENDED DC OPERATING CONDITIONS (-40°C to +85°C)

PARAMETER	SYMBOL	MIN	TYP	MAX	UNITS	NOTES
Supply Voltage	V_{CC}	0.0		5.5	V	1

DC ELECTRICAL CHARACTERISTICS (-40°C to +85°C; $V_{CC} = 1.2V$ to 5.5V)

PARAMETER	SYMBOL	MIN	TYP	MAX	UNITS	NOTES
Output Current @ 0.4V	I_{OL}	+10			mA	2, 3
Operating Current $V_{CC} < 5.5V$	I_{CC}		28	35	μA	4
V_{CC} Trip Point (DS1816-5)	V_{CCTP}	2.98	3.06	3.15	V	1
V_{CC} Trip Point (DS1816-10)	V_{CCTP}	2.80	2.88	2.97	V	1
V_{CC} Trip Point (DS1816-20)	V_{CCTP}	2.47	2.55	2.64	V	1
Internal Pull-Up Resistor	R_P	3.5	5.5	7.5	k Ω	7
Output Capacitance	C_{OUT}			10	pF	

AC ELECTRICAL CHARACTERISTICS (-40°C to +85°C; $V_{CC} = 1.2V$ to 5.5V)

PARAMETER	SYMBOL	MIN	TYP	MAX	UNITS	NOTES
RESET Active Time	t_{RST}	100	150	250	ms	5
V_{CC} Detect to \overline{RST}	t_{RPD}		2	5	μs	
V_{CC} Slew Rate (V_{CCTP} (MAX) to V_{CCTP} (MIN))	t_F	300			μs	8
V_{CC} Slew Rate (V_{CCTP} (MIN) to V_{CCTP} (MAX))	t_R	0			ns	
V_{CC} Detect to \overline{RST}	t_{RPU}	100	150	250	ms	5, 6

NOTES:

1. All voltages are referenced to ground.
2. Measured with $V_{CC} \geq 2.7V$.
3. A $1k\Omega$ external pull-up resistor may be required in some applications for proper operation of the microprocessor reset control circuit.
4. Measured with \overline{RST} output open.
5. Measured with $2.7V \leq V_{CC} \leq 3.3V$.
6. $t_R = 5\mu s$
7. V_{OH} and I_{OH} are a function of the value of R_P and the associated output load conditions.
8. The t_F value is for reference in defining values for t_{RPD} and should not be considered a requirement for proper operation or use of the device.

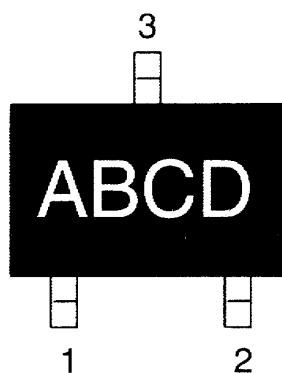
PART MARKING CODES

“A”, “B”, & “C” represent the device type.



810 DS1810
 811 DS1811
 812 DS1812
 813 DS1813
 815 DS1815
 816 DS1816
 817 DS1817
 818 DS1818

“D” represents the device tolerance.

A 5%
 B 10%
 C 15%
 D 20%

Looking for pricing, stock, or lifecycle information?

Click below to explore more details on WIN SOURCE:

-  [View DS1816R-5+T&R on WIN SOURCE](#)
-  [Maxim Integrated Information](#)

Optimize Your Supply Chain with WIN SOURCE Solutions

-  Global Sourcing Solution
-  Obsolete Management
-  Cost Control Management
-  Shortage Management
-  Alternative Solution
-  Excess Inventory Management