



**THE DATASHEET OF
MIC2586R-1YM**





MIC2586/MIC2586R

Single-Channel, Positive High-Voltage Hot Swap Controller/Sequencer

NOT RECOMMENDED FOR NEW DESIGNS

General Description

The MIC2586 and MIC2586R are single-channel positive voltage hot swap controllers/sequencers designed to provide safe insertion and removal of boards for systems that require live (always-powered) backplanes. These devices use few external components and act as controllers for external N-channel power MOSFET devices to provide inrush current control and output voltage slew rate control. Overcurrent fault protection is provided via programmable analog foldback current-limit circuitry equipped with a programmable overcurrent filter. These protection circuits combine to limit the power dissipation of the external MOSFET to insure that the MOSFET is in its SOA during fault conditions.

The MIC2586 provides a circuit breaker function that latches the output MOSFET off if the load current exceeds the current-limit threshold for the duration of the programmable timer. Conversely, the MIC2586R will attempt to restart power after a load current fault with a low duty cycle to prevent the MOSFET from overheating. Each device provides either an active-HIGH (-1BM) or an active-LOW (-2BM) "power-is-good" (PWRGD) signal. The MIC2586 and the MIC2586R provide up to three, time-sequenced PWRGD outputs that can be used as a control for DC/DC converter circuits or power modules.

Data sheets and support documentation can be found on Micrel's web site at: www.micrel.com.

Features

- Operates from +10V to +80V with 100V ABS MAX operation
- Industrial temperature specifications at $V_{CC} = +24V$ and $V_{CC} = +48V$
- Programmable current limit with analog foldback
- Active current regulation minimizes inrush current
- Electronic circuit breaker for overcurrent fault protection
- Output latch off (MIC2586) or output auto-retry (MIC2586R)
- Fast responding circuit breaker ($< 2\mu s$) to short-circuit loads
- Programmable input undervoltage lockout
- Fault Reporting:
 - Three open-drain PWRGD outputs for enabling DC/DC converter(s)
 - Active-HIGH: MIC2586-1/MIC2586R-1
 - Active-LOW: MIC2586-2/MIC2586R-2

Applications

- General-purpose hot board insertion
- High-voltage, high-side electronic circuit breaker
- +12V/+24V/+48V distributed power systems
- +24V/+48V industrial/alarm systems
- Telecom systems
- Medical systems

Ordering Information

Part Number		PWRGD Polarity	Circuit Breaker Function	Package
Standard	Pb-Free			
MIC2586-1BM	MIC2586-1YM	Active-HIGH	Latched	14-Pin SOIC
MIC2586-2BM	MIC2586-2YM	Active-LOW	Latched	14-Pin SOIC
MIC2586R-1BM	MIC2586R-1YM	Active-HIGH	Auto-Retry	14-Pin SOIC
MIC2586R-2BM	MIC2586R-2YM	Active-LOW	Auto-Retry	14-Pin SOIC

Pin Configuration

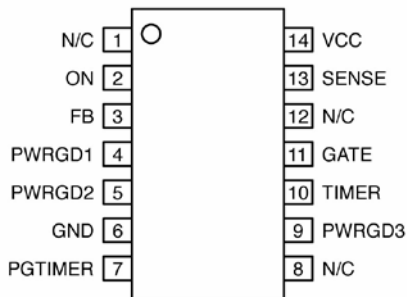

14-Pin SOIC (M)
MIC2586-1BM
MIC2586R-1BM

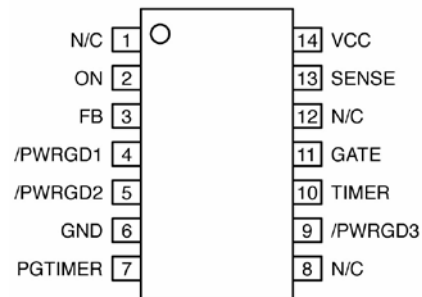

14-Pin SOIC (M)
MIC2586-1BM
MIC2586R-1BM

Pin Description

Pin Number	Pin Name	Pin Function
1, 8, 12	NC	Reserved: Make no external connections to these pins.
2	ON	Enable Input: When the voltage at the ON pin is higher than the V_{ONH} threshold, a start cycle is initiated. An internal current source (I_{GATEON}) is activated which charges the GATE pin, ramping up the voltage at this pin to turn on an external MOSFET. Whenever the voltage at the ON pin is lower than the V_{ONL} threshold, an undervoltage lockout condition is detected and the I_{GATEON} current source is disabled while the GATE pin is pulled low by another internal current source ($I_{GATEOFF}$). After a load current fault, toggling the ON pin LOW will reset the circuit breaker then back HIGH (ON pin) will initiate another start cycle.
3	FB	Output Voltage Feedback Input: This pin is connected to an external resistor divider that is used to sample the output load voltage. The voltage at this pin is measured against an internal comparator whose output controls the PWRGD (or /PWRGD) signal. PWRGD (or /PWRGD) asserts when the FB pin voltage crosses the V_{FBH} threshold. When the FB pin voltage is lower than its V_{FBL} threshold, PWRGD (or /PWRGD) is deasserted. The FB comparator exhibits a typical hysteresis of 80mV. The FB pin voltage also affects the MIC2586/MIC2586R's foldback current limit operation (see the <i>Functional Description</i> section for further information).

Pin Description (Continued)

Pin Number	Pin Name	Pin Function
4	PWRGD1 (MIC2586-1) (MIC2586R-1) Active-HIGH /PWRGD1 (MIC2586-2) (MIC2586R-2) Active-LOW	<p>Power-is-Good (PWRGD1 or /PWRGD1), Open-Drain Output: This pin remains deasserted during start up while the FB pin voltage is below the V_{FBH} threshold. Once the voltage at the FB pin rises above the V_{FBH} threshold, the PWRGD output asserts with minimal delay (typically $\leq 5\mu\text{s}$).</p> <p>For the (-1) options, the PWRGDx output pin will be high-impedance when the FB pin voltage is higher than V_{FBH} and will pull down to GND when the FB pin voltage is less than V_{FBL}.</p> <p>For the (-2) options, the /PWRGDx output pin will be high-impedance when the FB pin voltage is lower than V_{FBL} and will pull down to GND when the FB pin voltage is higher than V_{FBH}.</p> <p>Each PWRGD output pin is connected to an open-drain, N-channel transistor implemented with high-voltage structures. These transistors are capable of operating with pull-up resistors to supply voltages as high as 100V.</p> <p>To use this signal as a logic control in low-voltage DC/DC conversion applications, an external pull-up resistor between this pin and the logic supply voltage is recommended, unless an internal pull-up impedance is provided by the DC/DC module or other device (load).</p>
5	PWRGD2 (MIC2586-1) (MIC2586R-1) Active-HIGH /PWRGD2 (MIC2586-2) (MIC2586R-2) Active-LOW	<p>Power-is-Good 2 (PWRGD2 or /PWRGD2), Open-Drain Output: For the (-1) option, this output signal is asserted when the following is true: PWRGD1 = Asserted AND the PWRGD1-to-PWRGD2 delay ($t_{PG(1-2)}$) has elapsed, where $t_{PG(1-2)}$ is the time delay programmed by the capacitor (C_{PG}) connected to the PGTIMER pin. Once PWRGD1 is asserted, an internal current source (I_{CPG}) begins to charge C_{PG}. When the voltage on C_{PG} crosses the V_{PG2} threshold (typically, 0.625V), PWRGD2 is asserted. The same description above applies to the (-2) option. For further information, refer to the PWRGD1 and PGTIMER pin descriptions.</p> <p>To use this signal as a logic control in low-voltage DC/DC conversion applications, an external pull-up resistor between this pin and the logic supply voltage is recommended, unless internal pull-up impedance is provided by the DC/DC module or other device (load).</p>
7	PGTIMER	<p>Power-is-Good Delay Timer: A capacitor (C_{PG}) connected from this pin to GND sets a delay from PWRGD1 to PWRGD2 ($t_{PG(1-2)}$) and from PWRGD1 to PWRGD3 ($t_{PG(1-3)}$). An internal current source (I_{CPG}) is used to charge C_{PG} only after PWRGD1 has been asserted. The same description applies to the active-LOW (-2) output signals.</p>
9	PWRGD3 (MIC2586-1) (MIC2586R-1) Active-HIGH /PWRGD3 (MIC2586-2) (MIC2586R-2) Active-LOW	<p>Power-is-Good Output 3 (PWRGD3 or /PWRGD3), Open-Drain Output: For the (-1) option, this output signal is asserted when the following is true: PWRGD1 = Asserted AND the PWRGD1-to-PWRGD3 delay ($t_{PG(1-3)}$) has elapsed, where $t_{PG(1-3)}$ is the time delay programmed by the capacitor (C_{PG}) connected to the PGTIMER pin. Once PWRGD1 is asserted, an internal current source (I_{CPG}) begins to charge C_{PG}. When the voltage on C_{PG} crosses the V_{PG3} threshold (typically, 1.25V), PWRGD3 is asserted. The same description above applies to the (-2) option. For further information, refer to the PWRGD1 and PGTIMER pin descriptions.</p> <p>To use this signal as a logic control in low-voltage DC/DC conversion applications, an external pull-up resistor between this pin and the logic supply voltage is recommended, unless internal pull-up impedance is provided by the DC/DC module or other device (load).</p>
10	TIMER	<p>Current-Limit Response Timer: A capacitor connected from this pin to GND provides overcurrent filtering to prevent nuisance “tripping” of the circuit breaker by setting the time (t_{FLT}) for which the controller is allowed to remain in current limit. Once the MIC2586 circuit breaker trips, the output latches off. Under normal (steady-state) operation, the TIMER pin is held to GND by an internal 3.5μA current source ($I_{TIMERDN}$). When the voltage across the external sense resistor exceeds the V_{TRIP} threshold, an internal 65μA current source ($I_{TIMERUP}$) is activated to charge the capacitor connected to the TIMER pin. When the TIMER pin voltage reaches the V_{TIMERH} threshold, the circuit breaker is tripped pulling the GATE pin low, the $I_{TIMERUP}$ current source is disabled, and the TIMER pin capacitor is discharged by the $I_{TIMERDN}$ current source. When the voltage at the TIMER pin is less than 0.5V, the MIC2586 can be restarted by toggling the ON pin LOW then HIGH.</p> <p>For the MIC2586R, the capacitor connected to the TIMER pin sets the period of auto-retry where the duty cycle is fixed at a nominal 5%.</p>

Pin Description (Continued)

Pin Number	Pin Name	Pin Function
11	GATE	<p>Gate Drive Output: This pin is the output of an internal charge pump connected to the gate of an external, N-channel power MOSFET. The charge pump has been designed to provide a minimum gate drive ($\Delta V_{GATE} = V_{GATE} - V_{CC}$) of +7.5V over the input supply's full operating range. When the ON pin voltage is higher than the V_{ONH} threshold, a 16μA current source (I_{GATEON}) charges the GATE pin.</p> <p>When in current limit, the output voltage at the GATE pin is adjusted so that the voltage across the external sense resistor is held equal to V_{TRIP} while the capacitor connected to the TIMER pin charges. If the current-limit condition goes away <u>before</u> the TIMER pin voltage rises above the V_{TIMERH} threshold, then steady-state operation resumes.</p> <p>The GATE output pin is shut down whenever: (1) the input supply voltage is lower than the V_{UVL} threshold, (2) the ON pin voltage is lower than the V_{ONL} threshold, (3) the TIMER pin voltage is higher than the V_{TIMERH} threshold, or (4) the difference between the VCC and SENSE pins is greater than V_{TRIP} while the TIMER pin is grounded. For cases (3) and (4) – overcurrent fault conditions – the GATE is immediately pulled to ground by $I_{GATEFLT}$, a 30mA (minimum) pulldown current.</p>
13	SENSE	<p>Circuit Breaker Sense Input: This pin is the (-) Kelvin sense connection for the output supply rail. A low-valued resistor (R_{SENSE}) between this pin and the VCC pin sets the circuit breaker's current limit trip point. When the current limit detector circuit is enabled (as well as the current-limit timer), while the FB pin voltage remains higher than 1V, the voltage across the sense resistor ($V_{CC} - V_{SENSE}$) will be regulated to V_{TRIP} (47mV, typically) to maintain a constant current into the load. When the FB pin voltage is less than $\approx 0.8V$, the voltage across the sense resistor decreases linearly to a minimum of 12mV (typical) when the FB pin voltage is at 0V.</p> <p>To disable the circuit breaker (and defeat all current limit protections), the SENSE pin and the VCC pin can be tied together.</p>
14	VCC	<p>Positive Supply Voltage Input: This pin is the (+) Kelvin sense connection for the output supply rail. The nominal operating voltage range for the MIC2586 and the MIC2586R is +10V to +80V, and VCC can withstand input transients up to +100V. An undervoltage lockout circuit holds the GATE pin low whenever the supply voltage to the MIC2586/MIC2586R is less than the V_{UVH} threshold.</p>

Absolute Maximum Ratings⁽¹⁾

(All voltages are referred to GND)

Supply Voltage (V_{CC})	-0.3V to +100V
GATE	-0.3V to +100V
ON, SENSE	-0.3V to +100V
PWRGDx, /PWRGDx	-0.3V to +100V
FB	-0.3V to +100V
TIMER, CPG	-0.3V to +6V
ESD Rating ⁽³⁾	
Human Body Model	2kV
Machine Model	200V
Lead Temperature (soldering)	
Standard Package (-xBM)	
IR Reflow	240°C + 0°C/-5°C
Lead-Free Package (-xYM)	
IR Reflow	260°C + 0°C/-5°C

Operating Ratings⁽²⁾

Supply Voltage (V_{CC})	+10V to +80V
Ambient Temperature (T_A)	-40°C to +85°C
Junction Temperature (T_J)	+125°C
Package Thermal Resistance	
14-Pin SOIC	120°C/W

DC Electrical Characteristics⁽⁴⁾

$V_{CC} = +24V$ and $+48V$; $T_A = 25^\circ C$, unless otherwise noted. **Bold** values indicate specifications apply over the full operating temperature range of $-40^\circ C$ to $+85^\circ C$.

Symbol	Parameter	Condition	Min.	Typ.	Max.	Units
V_{CC}	Supply Voltage		10		80	V
I_{CC}	Supply Current			2	5	mA
V_{UVH} V_{UVL}	Supply Voltage Undervoltage Lockout	V_{CC} rising V_{CC} falling	7.5 7.0	8.0 7.5	8.5 8.0	V
V_{HYSLO}	V_{CC} Undervoltage Lockout Hysteresis			500		mV
V_{FBH}	Feedback Pin Voltage High Threshold	FB Low-to-High transition	1.280	1.313	1.345	V
V_{FBL}	Feedback Pin Voltage Low Threshold	FB High-to-Low transition	1.208	1.233	1.258	V
V_{HYSFB}	Feedback Voltage Hysteresis			80		mV
ΔV_{FB}	FB Pin Threshold Line Regulation	$10V \leq V_{CC} \leq 80V$	-0.05		0.05	mV/V
I_{FB}	FB Pin Input Current	$0V \leq V_{FB} \leq 3V$	-1		1	μA
V_{TRIP}	Circuit Breaker Trip Voltage, $V_{CC} - V_{SENSE}$	$V_{FB} = 0V$ (see Figure 1) $V_{FB} = 1V$ (see Figure 1)	5 39	12 47	17 55	mV
ΔV_{GATE}	MOSFET Gate Drive, $V_{GATE} - V_{CC}$	$+10V \leq V_{CC} \leq +80V$	7.5		18	V
I_{GATEON}	GATE Pin Pull-Up Current	Start cycle, $V_{GATE} = 7V$	-10	-16	-22	μA
$I_{GATEFLT}$	GATE Pin Rapid Pull-Down Current (in fault condition, until $V_{GATE} = V_{GATE[TH]}$)	$(V_{CC} - V_{SENSE}) = (V_{TRIP} + 10mV)$ $V_{GATE} = 5V$	30	80	200	mA
$I_{GATEOFF}$	GATE Pin Turn-Off Current	Normal turn-off, or from $V_{GATE[TH]}$ (MOSFET) to 0V after a fault condition		1.8		mA

Notes:

- Exceeding the absolute maximum rating may damage the device.
- The device is not guaranteed to function outside its operating rating.
- Devices are ESD sensitive. Handling precautions recommended. Human body model, 1.5k in series with 100pF.
- Specification for packaged product only.

DC Electrical Characteristics⁽⁴⁾ (Continued)

$V_{CC} = +24V$ and $+48V$; $T_A = 25^\circ C$, unless otherwise noted. **Bold** values indicate specifications apply over the full operating temperature range of $-40^\circ C$ to $+85^\circ C$.

Symbol	Parameter	Condition	Min.	Typ.	Max.	Units
$I_{TIMERUP}$	TIMER Pin Charging Current	$(V_{CC} - V_{SENSE}) > V_{TRIP}$ $V_{TIMER} = 0V$	-24	-65	-120	μA
$I_{TIMERDN}$	TIMER Pin Pull-Down Current	$(V_{CC} - V_{SENSE}) < V_{TRIP}$ $V_{TIMER} = 0.6V$	1.5	3.5	5	μA
V_{TIMERH}	TIMER Pin High Threshold Voltage		1.280	1.313	1.345	V
V_{TIMERL}	TIMER Pin Low Threshold Voltage		0.4	0.49	0.6	V
V_{ONH}	ON Pin High Threshold Voltage	ON Low-to-High transition	1.280	1.313	1.355	V
V_{ONL}	ON Pin Low Threshold Voltage	ON High-to-Low transition	1.208	1.233	1.258	V
V_{HYSON}	ON Pin Hysteresis			80		mV
I_{ON}	ON Pin Input Current	$0V \leq V_{ON} \leq 80V$			2	μA
V_{OL}	Power-Good Output Voltage	PWRGDx or /PWRGDx = LOW $I_{OL} = 1.6 mA$ $I_{OL} = 4 mA$			0.4 0.8	V
I_{OFF}	Power-Good Leakage Current	PWRGDx or /PWRGDx = Open-Drain $V_{PGx} = V_{CC}$, $V_{ON} = 1.5V$			10	μA
I_{CPG}	Power-Good Delay Capacitor Charging Current	$V_{PGTIMER} = 0.6V$ $V_{CC} = 10V, 24V, 48V, 80V$	4	7	10	μA
V_{PG2}	PGTIMER Threshold Voltage to Assert PWRGD2 (MIC2586/86R-1) or /PWRGD2 (MIC2586/86R-2)		0.5	0.625	0.7	V
V_{PG3}	PGTIMER Threshold Voltage to Assert PWRGD3 (MIC2586/86R-1) or /PWRGD2 (MIC2586/86R-2)		1.04	1.25	1.46	V

AC Electrical Characteristics⁽⁴⁾

$V_{CC} = +24V$ and $+48V$; $T_A = 25^\circ C$, unless otherwise noted. **Bold** values indicate specifications apply over the full operating temperature range of $-40^\circ C$ to $+85^\circ C$.

Symbol	Parameter	Condition	Min.	Typ.	Max.	Units
t_{PONLH}	ON High to GATE High	IRF530, $C_{GATE} = 10nF$		3		ms
t_{PONHL}	ON Low to GATE Low	$V_{IN} = 48V$, IRF530, $C_{GATE} = 10nF$		1		ms
t_{PFBLH}	FB Valid to PWRGDx High (MIC2586/86R-1)	$R_{PG} = 50k\Omega$ pull-up to 48V, $C_L = 100pF$		2		μs
t_{PFBHL}	FB Invalid to PWRGDx Low (MIC2586/86R-1)	$R_{PG} = 50k\Omega$ pull-up to 48V, $C_L = 100pF$		4		μs
t_{PFBHL}	FB Valid to /PWRGDx Low (MIC2586/86R-2)	$R_{PG} = 50k\Omega$ pull-up to 48V, $C_L = 100pF$		4		μs
t_{PFBHL}	FB Invalid to /PWRGDx High (MIC2586/86R-2)	$R_{PG} = 50k\Omega$ pull-up to 48V, $C_L = 100pF$		2		μs
$t_{PG(1-2)}$	Delay from PWRGD1 to PWRGD2 or Delay from /PWRGD1 to /PWRGD2	$C_{PG} = 0.1\mu F$		21		ms
$t_{PG(1-3)}$	Delay from PWRGD1 to PWRGD3 or Delay from /PWRGD1 to /PWRGD3	$C_{PG} = 0.1\mu F$		42		ms
$t_{OCSENSE}$	Overcurrent Sense to GATE Low Trip Time	$(V_{CC} - V_{SENSE}) = (V_{TRIP} + 10mV)$ (see Figure 7)		1	2	μs

Timing Diagrams

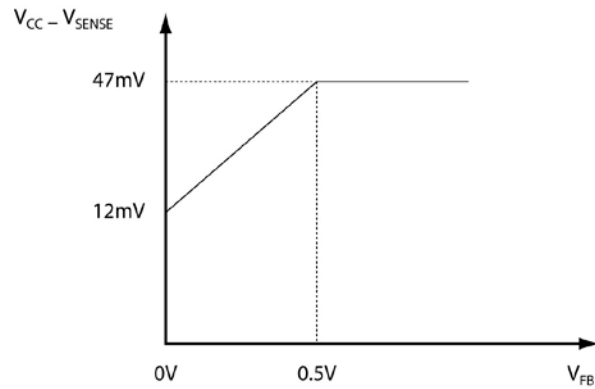

Figure 1. Foldback Current-Limit Transfer Characteristic

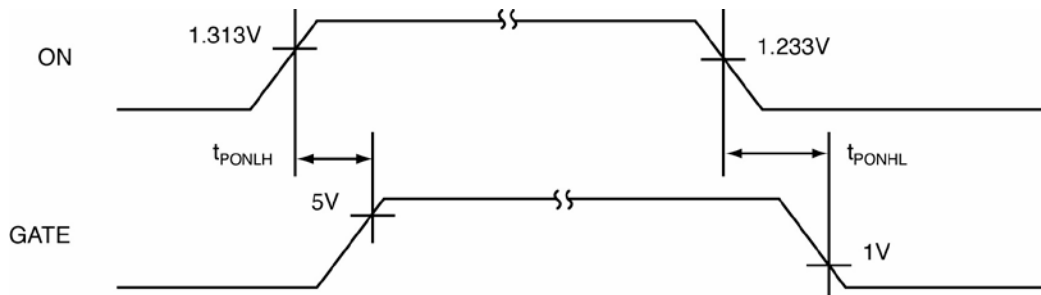

Figure 2. ON-to-Gate Timing

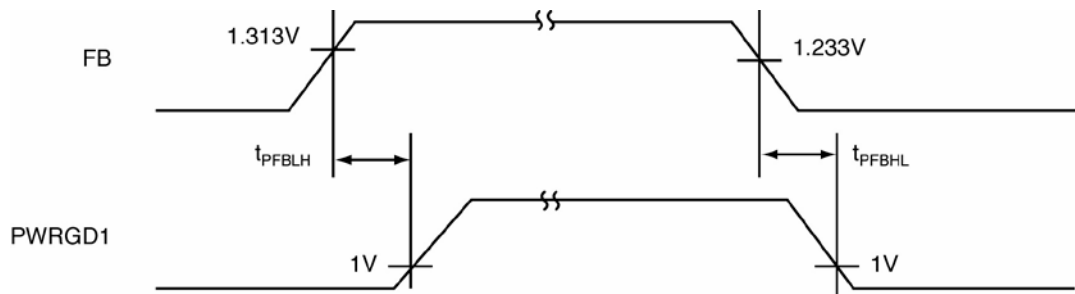

Figure 3. MIC2586/86R-1 FB-to-PWRGD1 Timing

Timing Diagrams (Continued)

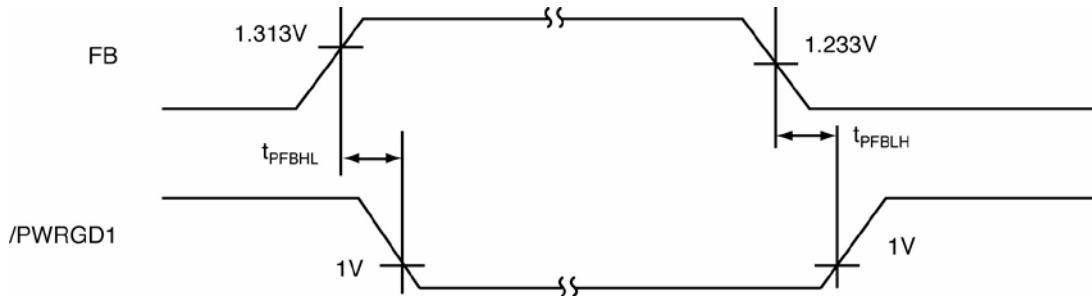

Figure 4. MIC2586/86R-2 FB-to-/PWRGD1 Timing

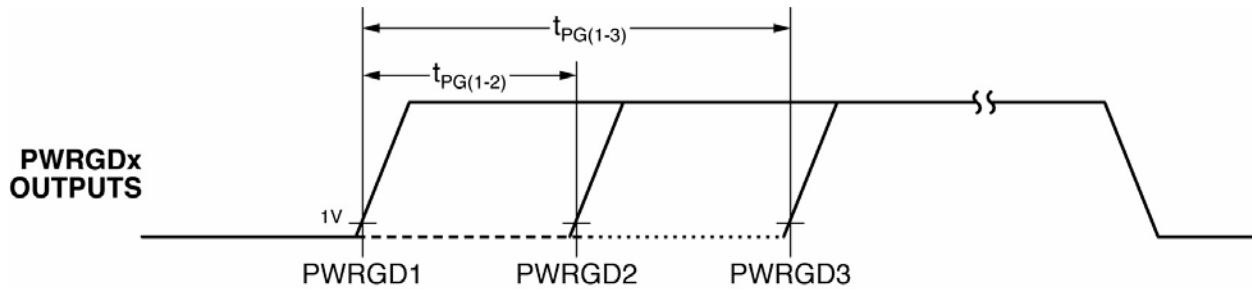

Figure 5. MIC2586/86R-1 Multiple PWRGDx Timing

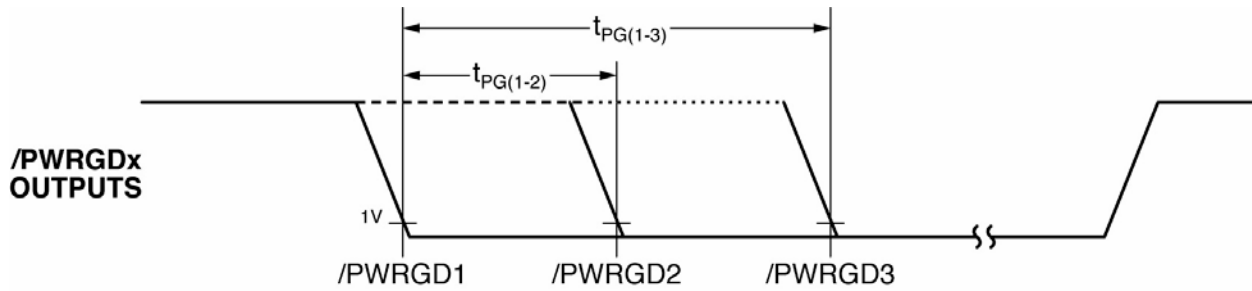

Figure 6. MIC2586/86R-2 Multiple /PWRGDx Timing

Timing Diagrams (Continued)

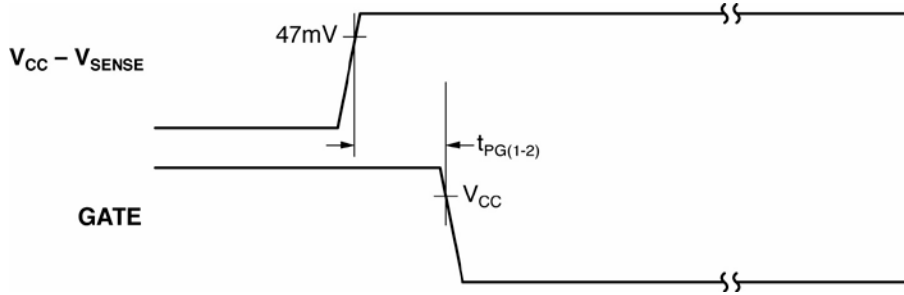
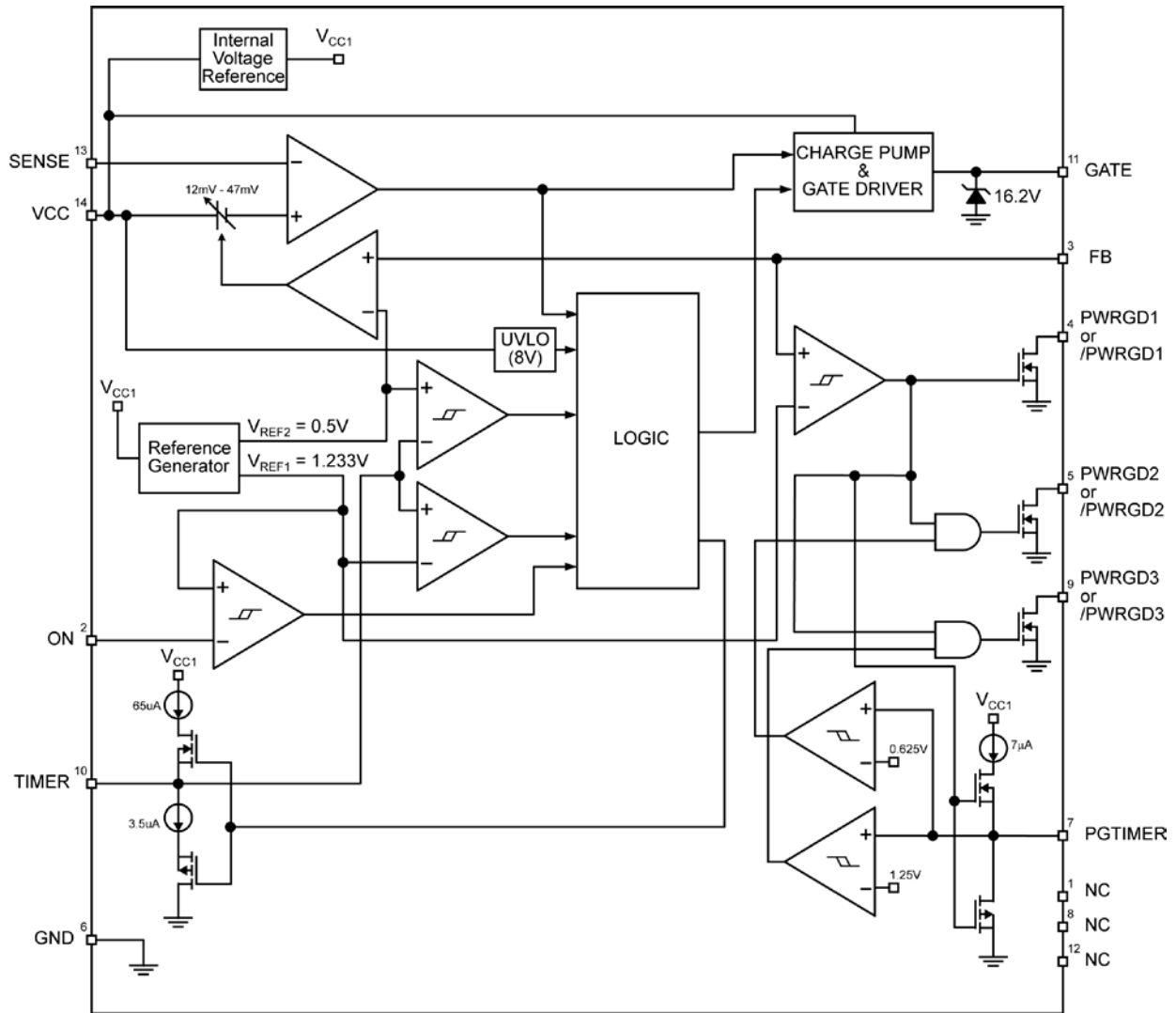

Figure 7. Overcurrent Sense-to-GATE Timing

Functional Block Diagram



MIC2586/MIC2586R Block Diagram

Functional Description

Hot Swap Insertion

When circuit boards are inserted into systems carrying live supply voltages ("hot swapped"), high inrush currents often result due to the charging of bulk capacitance that resides across the circuit board's supply pins. These current spikes can cause the system's supply voltages to temporarily go out of regulation causing data loss or system lock-up. In more extreme cases, the transients occurring during a hot swap event may cause permanent damage to connectors or on-board components.

The MIC2586/MIC2586R is designed to address these issues by limiting the maximum current that is allowed to flow during hot swap events. This is achieved by implementing a constant-current control loop at turn-on. In addition to inrush current control, the MIC2586 and MIC2586R incorporate input voltage supervisory functions and user-programmable overcurrent protection, thereby providing robust protection for both the system and the circuit board.

Input Supply Transient Suppression and Filtering

The MIC2586/MIC2586R is guaranteed to withstand transient voltage spikes up to 100V. However, voltage spikes in excess of 100V may cause damage to the controller. In order to suppress transients caused by parasitic inductances, wide (and short) power traces should be utilized. Alternatively, a heavier trace plating will help minimize inductive spikes that may arise during events (e.g., short-circuit loads) that can cause a large di/dt to occur. External surge protection, such as a clamping diode, is also recommended as an added safeguard for device (and system) protection. Lastly, a 0.1µF filter capacitor is recommended to help reject additional noise.

Start-Up Cycle

When the power supply voltage to the MIC2586/MIC2586R is higher than the V_{UVH} and the V_{ONH} threshold voltages, a start cycle is initiated. When the controller is enabled, an internal 16µA current source (I_{GATEON}) is enabled and the GATE pin voltage rises from 0V with respect to ground at a rate equal to Equation 1:

$$\frac{dV_{GATE}}{dt} = \frac{I_{GATEON}}{C_{GATE}} \quad \text{Eq. 1}$$

The internal charge pump has sufficient output drive to fully enhance commonly available power MOSFETs for the lowest possible DC losses. The gate drive is guaranteed to be between 7.5V and 18V over the entire supply voltage operating range (10V to 80V), so 60V BVDSS and 30V BVDSS N-channel power MOSFETs can be used for +48V and +24V applications, respectively. However, an external Zener diode (18-V) connected from the source to the gate as shown in the typical applications circuit is highly recommended. A good choice for an 18-V Zener diode in this application is the MMSZ5248B, available in a small SOD123 package.

C_{GATE} is used to adjust the GATE voltage slew rate while R3 minimizes the potential for high-frequency parasitic oscillations from occurring in M1. However, note that resistance in this part of the circuit has a slight destabilizing effect upon the MIC2586/MIC2586R's current regulation loop. Compensation resistor R4 is necessary for stabilization of the current regulation loop. The current through the power transistor during initial inrush is given by Equation 2:

$$I_{INRUSH} = C_{LOAD} \times \frac{I_{GATEON}}{C_{GATE}} \quad \text{Eq. 2}$$

The drain current of the MOSFET is monitored via an external current sense resistor to ensure that it never exceeds the programmed threshold, as described in the "Circuit Breaker Operation" subsection.

A capacitor connected to the controller's TIMER pin sets the value of overcurrent detector delay, t_{FLT} , which is the time for which an overcurrent event must last to signal a fault condition and to cause an output latch-off. These devices will be driving a capacitive load in most applications, so a properly chosen value of C_{TIMER} prevents false-, or nuisance-, tripping at turn-on as well as providing immunity to noise spikes after the start-up cycle is complete. The procedure for selecting a value for C_{TIMER} is given in the "Circuit Breaker Operation" subsection.

Overcurrent Protection

The MIC2586 and the MIC2586R use an external, low-value resistor in series with the drain of the external MOSFET to measure the current flowing into the load. The VCC connection (Pin 14) and the SENSE connection (Pin 13) are the (+) and (-) inputs, respectively, of the device's internal current sensing circuits. Kelvin sense connections are strongly recommended for sensing the voltage across these pins. See the *Applications Information* section for further details.

The nominal current limit is determined by Equation 3:

$$I_{LIMIT} = \frac{V_{TRIP(TYP)}}{R_{SENSE}} \quad \text{Eq. 3}$$

where $V_{TRIP(TYP)}$ is the typical current limit threshold specified in the datasheet and R_{SENSE} is the value of the selected sense resistor. As the MIC2586 and the MIC2586R employ a constant-current regulation scheme in current limit, the charge pump's output voltage at the GATE pin is adjusted so that the voltage across the external sense resistor is held equal to V_{TRIP} while the capacitor connected to the TIMER pin is being charged. If the current-limit condition goes away before the TIMER pin voltage rises above the V_{TIMERH} threshold, then steady-state operation resumes. To prevent excessive power dissipation in the external MOSFET under load current fault conditions, the FB pin voltage is used as the control element in a circuit that lowers the current limit as a function of the output voltage. When the load current increases to the point where the output voltage at the load approaches 0V (likewise, the MIC2586/MIC2586R's FB pin voltage also approaches 0V), the result is a proportionate decrease in the maximum current allowed into the load. This foldback current limit subcircuit's transfer characteristic is shown in Figure 1. Under excessive load conditions (output and FB voltage equals 0V), the foldback current limiting circuit controls the MIC2586/MIC2586R's GATE drive to force a constant 12mV (typical) voltage drop across the external sense resistor.

Circuit Breaker Operation

The MIC2586/MIC2586R employ an electronic circuit breaker that protects the external N-channel power MOSFET and other system components against large-scale output current faults, both during initial card insertion or during steady-state operation. The current-limit threshold is set via an external resistor, R_{SENSE} , connected between the circuit's VCC pin and SENSE pin. For the MIC2586/MIC2586R, a fault current timing circuit is set via an external capacitor (C_{TIMER}) that determines the length of the time delay (t_{FLT}) for which the controller remains in current limit before the circuit breaker is tripped. Programming the response time of the overcurrent detector helps to prevent nuisance tripping of the circuit breaker because of high inrush currents charging bulk and distributed capacitive loads.

The nominal overcurrent response time is calculated using Equation 4:

$$t_{FLT}(\text{ms}) = \frac{C_{FILTER} \times V_{TIMERH}}{I_{TIMERUP}} \quad \text{Eq. 4}$$

$$t_{FLT}(\text{ms}) = 20 \times C_{FILTER}(\mu\mu\text{F})$$

Whenever the voltage across R_{SENSE} exceeds the MIC2586/MIC2586R's nominal circuit breaker threshold voltage of 47mV during steady-state operation, two things occur:

1. A constant-current regulation loop will engage within 1 μ s after an overcurrent condition is detected by R_{SENSE} , and the control loop is designed to hold the voltage across R_{SENSE} equal to 47mV. This feature protects both the load and the MIC2586/MIC2586R circuits from excessively high currents.
2. Capacitor C_{TIMER} is then charged up to the V_{TIMERH} threshold (1.313V) by an internal 65 μ A current source ($I_{TIMERUP}$). If the excessive current persists such that the voltage across C_{TIMER} crosses the V_{TIMERH} threshold, the circuit breaker trips and the GATE pin is immediately pulled low by a 30mA (minimum) internal current sink. This operation turns off the MOSFET quickly and disconnects the input from the load. The value of C_{TIMER} should be selected to allow the circuit's minimum regulated output current (I_{OUT}) to equal I_{LIMIT} for somewhat longer than the time it takes to charge the total load capacitance.

An initial value for C_{TIMER} is found by calculating the time it will take for the MIC2586/MIC2586R to completely charge up the output capacitive load. Assuming the load is enabled by the PWRGDx (or /PWRGDx) signal(s) of the controller, the turn-on delay time is derived from the following expression, $I = C \times (dV/dt)$:

$$t_{TURN-ON} = \frac{C_{LOAD} \times V_{CC(MAX)}}{I_{LIMIT}} \quad \text{Eq. 5}$$

Using parametric values for the MIC2586/MIC2586R, an expression relating a worst-case design value for C_{TIMER} , using the MIC2586/MIC2586R specification limits, to the circuit's turn-on delay time is:

$$C_{\text{TIMER(MAX)}} = \frac{t_{\text{TURN-ON}} \times I_{\text{TIMERUP(MAX)}}}{V_{\text{TIMERH(MIN)}}}$$

$$C_{\text{TIMER(MAX)}} = t_{\text{TURN-ON}} \times \left(\frac{120\mu\text{A}}{1.280\text{V}} \right)$$

$$C_{\text{TIMER(MAX)}} = t_{\text{TURN-ON}} \times \left(94 \times 10^{-6} \frac{\mu\text{F}}{\text{sec}} \right)$$

Eq. 6

For example, in a system with a $C_{\text{LOAD}} = 1000\mu\text{F}$, a maximum $V_{\text{CC}} = +72\text{V}$, and a maximum load current on a nominal +48V buss of 1.65A, the nominal circuit design equations steps are:

1. Choose $I_{\text{LIMIT}} = I_{\text{HOT_SWAP(NOM)}} = 2\text{A}$ (1.65A + 20%)
2. Select an R_{SENSE} (Closest 1% standard value is 19.6m Ω)
3. Using $I_{\text{CHARGE}} = I_{\text{LIMIT}} = 2\text{A}$, the application circuit turn-on time is calculated using Equation 5:

$$t_{\text{TURN-ON}} = \frac{(1000\mu\text{F} \times 72\text{V})}{2\text{A}} = 36\text{ms}$$

Allowing for capacitor tolerances and a nominal 36ms turn-on time, an initial worst-case value for C_{TIMER} is:

$$C_{\text{TIMER(MAX)}} = 0.036\text{s} \times \left(94 \times 10^{-6} \frac{\mu\text{F}}{\text{sec}} \right) = 3.38\mu\text{F}$$

Eq. 7

The closest standard $\pm 5\%$ tolerance capacitor value is 3.3 μF and would be a good initial starting value for prototyping.

Whenever the MIC2586 is not in current limit, C_{TIMER} is discharged to GND by an internal 3.5 μA current sink (I_{TIMERDN}).

For the MIC2586R, the circuit breaker automatically resets after (20) $t_{\text{FLT_AUTO}}$ time constants. If the fault condition still exists, capacitor C_{TIMER} will begin to charge up to the V_{TIMERH} threshold, and if exceeded, trip the circuit breaker.

Capacitor C_{TIMER} will then be discharged by I_{TIMERDN} until the voltage across C_{TIMER} drops below the V_{TIMERL} threshold, at which time another start cycle is initiated. This will continue until any of the following occurs:

- a) The fault condition is removed.
- b) The input supply voltage power is removed/cycled
- c) The ON pin is toggled LOW then HIGH.

The duty cycle of the auto-restart function is therefore fixed at 5% and the period of the auto-restart cycle is given by:

$$t_{\text{AUTO_RESTART}} = 20 \times t_{\text{FLT_AUTO}}$$

$$t_{\text{AUTO_RESTART}} = 20 \times \frac{\left(C_{\text{TIMER}} \right) \times \left(V_{\text{TIMERH}} - V_{\text{TIMERL}} \right)}{I_{\text{TIMERUP}}}$$

$$t_{\text{AUTO_RESTART}} = C_{\text{TIMER}} \times \left(250 \frac{\text{ms}}{\mu\text{F}} \right)$$

Eq. 8

The auto-restart period for the example above where the worst-case C_{TIMER} was calculated to be 3.3 μF is:

$$t_{\text{AUTO_RESTART}} = 825\text{ms}$$

Input Undervoltage Lockout

The MIC2586/MIC2586R have an internal undervoltage lockout circuit that inhibits operation of the controller's internal circuitry unless the power supply voltage is stable and within an acceptable tolerance. If the supply voltage to the controller with respect to ground is greater than the V_{UVH} threshold voltage (8V typical), the controller's internal circuits are enabled and the controller is then ready for normal operation pending the state of the ON pin voltage. Once in steady-state operation, the controller's internal circuits remain active so long as the supply voltage with respect to ground is higher than the controller's internal V_{UVL} threshold voltage (7.5V typical).

Power Good (PWRGD) Output Signals

For the MIC2586-1/MIC2586R-1, the power good output signal PWRGD1 will be high impedance when the FB pin voltage is higher than the V_{FBH} threshold and will pull down to GND when the FB pin voltage is lower than the V_{FBL} threshold. For the MIC2586-2/MIC2586R-2, power-good output signal /PWRGD1 will pull down to GND when the FB pin voltage is higher than the V_{FBH} threshold and will be high impedance when the FB pin voltage is lower than the V_{FBL} threshold. Hence, the (-1) parts have an active-HIGH PWRGDx signal and the (-2) parts have an active-LOW /PWRGDx output. PWRGDx (or /PWRGDx) may be used as an enable signal for one or more DC/DC converter modules or for other system functions. When used as an enable signal, the time necessary for the PWRGDx (or /PWRGDx) signal to pull-up (when in high impedance state) will depend upon the (RC) load at the respective PWRGD pin.

PWRGD output signals PWRGD2 (/PWRGD2) and PWRGD3 (/PWRGD3) are asserted after the assertion of PWRGD1 (/PWRGD1) by a user-programmable time delay set by an external capacitor (CPG) from the controller's PGTIMER pin (Pin 7) to GND. An expression for the time delay to assert PWRGD2 (or /PWRGD2) after PWRGD1 (or /PWRGD1) asserts is given by:

$$t_{PG(1-2)} = \frac{C_{PG}}{I_{CPG}} \times V_{PG2} \quad \text{Eq. 9}$$

where V_{PG2} (0.625V, typically) is the PWRGD2 (or /PWRGD2) threshold voltage for PGTIMER and I_{CPG} (7 μ A, typically) is the internal PGTIMER pin charging current. Similarly, an expression for the time delay to assert PWRGD3 (or /PWRGD3) after PWRGD1 (or /PWRGD1) asserts is given by:

$$t_{PG(1-3)} = \frac{C_{PG}}{I_{CPG}} \times V_{PG3} \quad \text{Eq. 10}$$

where V_{PG3} (1.25V, typically) is the PWRGD3 (or /PWRGD3) threshold voltage for PGTIMER. Therefore, PWRGD2 (or /PWRGD2) will be delayed after the assertion of PWRGD1 (or /PWRGD1) by:

$$t_{PG(1-2)}(\text{ms}) \cong 90 \times C_{PG}(\mu\text{F}) \quad \text{Eq. 11}$$

PWRGD3 (/PWRGD3) follows the assertion of PWRGD1 (/PWRGD1) by a delay:

$$t_{PG(1-3)}(\text{ms}) \cong 180 \times C_{PG}(\mu\text{F}) \quad \text{Eq. 12}$$

For example, for a C_{PG} of 0.1 μ F, PWRGD2 (or /PWRGD2) will be asserted 9ms after PWRGD1 (or /PWRGD1). PWRGD3 (or /PWRGD3) will then be asserted 9ms after PWRGD2 (or /PWRGD2) and 18ms after the assertion of PWRGD1 (or /PWRGD1). The relationships between V_{OUT} , V_{FBH} , PWRGD1, PWRGD2, and PWRGD3 are shown in Figures 5 and 6.

Each PWRGD output pin is connected to an open-drain, N-channel transistor implemented with high-voltage structures. These transistors are capable of operating with pull-up resistors to supply voltages as high as 100V.

Application Information

External ON/OFF Control

The MIC2586/MIC2586R has an ON pin input that is used to enable the controller to commence a start-up sequence upon card insertion or to disable controller operation upon card removal. In addition, the ON pin can be used to reset the MIC2586/MIC2586R's internal electronic circuit breaker in the event of a load current fault. To reset the electronic circuit breaker, the ON pin is toggled LOW then HIGH. The ON pin is internally connected to an analog comparator with 80mV of hysteresis. When the ON pin voltage falls below its internal V_{ONL} threshold, the GATE pin is immediately pulled low. The GATE pin will be held low until the ON pin voltage is above its internal V_{ONH} threshold. The external circuit's ON threshold voltage level is programmed using a resistor divider (R1 and R2) as shown in the typical application circuit. The equations to set the trip points are shown below. For the following example, the external circuit's ON threshold is set to $V_{ONH(EX)} = +37V$, a value commonly used in +48V Central Office power distribution applications.

$$V_{ONH(EX)} = V_{ONH} \times \left(\frac{R1 + R2}{R2} \right) \quad \text{Eq. 13}$$

Given V_{ONH} and R2, a value for R1 can be determined. A suggested value for R2 is that which will provide approximately 100 μ A of current through the voltage divider chain at $V_{CC} = V_{ONH}$. This yields the following as a starting point:

$$R2 = \frac{V_{ONH(TYP)}}{100\mu A} = \frac{1.313V}{100\mu A} = 13.13k\Omega \quad \text{Eq. 14}$$

The closest standard 1% value for R2 is 13k Ω . Now, solving for R1 yields:

$$R1 = R2 \times \left[\left(\frac{V_{ONH(EX)}}{V_{ONH(TYP)}} \right) - 1 \right] = 13k\Omega \times \left[\left(\frac{37V}{1.313V} \right) - 1 \right] \\ = 353.3k\Omega$$

Eq.15

The closest standard 1% value for R1 is 357k Ω .

Using standard 1% resistor values, the external circuit's nominal ON and OFF thresholds are $V_{ON(EX)} = +36V$ and $V_{OFF(EX)} = +34V$. In solving for $V_{OFF(EX)}$, replace V_{ONH} with V_{ONL} in Equation 13.

Output Voltage PWRGD Detection

The MIC2586/86R includes an analog comparator used to monitor the output voltage of the controller through an external resistor divider as shown in the typical application circuit. The FB input pin is connected to the non-inverting input and is compared against an internal reference voltage. The analog comparator exhibits a hysteresis of 80mV.

Setting the PWRGD threshold for the circuit follows a similar approach as setting the circuit's ON/OFF input voltage. The equations to set the trip points are shown below. For the following +48V telecom application, power-is-good output signal PWRGD1 (or /PWRGD1) is to be de-asserted when the output supply voltage is lower than +48V-10% (+43.2V):

$$V_{OUT(NOT\ GOOD)} = V_{FBL} \times \left(\frac{R5 + R6}{R6} \right) \quad \text{Eq.16}$$

Given V_{FBL} and R6, a value for R5 can be determined. A suggested value for R6 is that which will provide approximately 100 μ A of current through the voltage divider chain at $V_{OUT(NOT\ GOOD)} = V_{FBL}$. This yields the following equation as a starting point:

$$R6 = \frac{V_{FBL(TYP)}}{100\mu A} = \frac{1.233V}{100\mu A} = 12.33k\Omega \quad \text{Eq. 17}$$

The closest standard 1% value for R6 is 12.4k Ω . Now, solving for R5 yields:

$$R5 = R6 \times \left[\left(\frac{V_{OUT(NOT\ GOOD)}}{V_{FBL(TYP)}} \right) - 1 \right] = 12.4k\Omega \times \left[\left(\frac{43.2V}{1.233V} \right) - 1 \right] \\ = 422k\Omega$$

Eq. 18

The closest standard 1% value for R5 is 422k Ω .

Using standard 1% resistor values, the external circuit's nominal "power-is-good" and "power-is-not-good" output voltages are $V_{OUT(GOOD)} = +46V$ and $V_{OUT(NOT\ GOOD)} = +43.2V$

In solving for $V_{OUT(GOOD)}$, substitute V_{FBH} for V_{FBL} in Equation 16.

Sense Resistor Selection

The sense resistor is nominally valued at:

$$R_{SENSE} = \frac{V_{TRIP(TYP)}}{I_{HOT_SWAP(NOM)}} \quad \text{Eq. 19}$$

where $V_{TRIP(TYP)}$ is the nominal circuit breaker threshold voltage (47mV) and $I_{HOT_SWAP(NOM)}$ is the nominal inrush load current level to trip the internal circuit breaker.

To accommodate worse-case tolerances in the sense resistor (for a $\pm 1\%$ initial tolerance, allow $\pm 3\%$ tolerance for variations over time and temperature) and circuit breaker threshold voltages, a slightly more detailed calculation must be used to determine the minimum and maximum hot swap load currents.

The MIC2586/MIC2586R has a minimum current limit threshold voltage of 39mV, thus the minimum hot swap load current is determined where the sense resistor is 3% high:

$$I_{HOT_SWAP(MIN)} = \frac{39\text{mV}}{(1.03 \times R_{SENSE(NOM)})} = \frac{37.9\text{mV}}{R_{SENSE(NOM)}} \quad \text{Eq. 20}$$

Keep in mind that the minimum hot swap load current should be greater than the application circuit's upper steady-state load current boundary. Once the lower value of R_{SENSE} has been calculated, it is good practice to check the maximum hot swap load current ($I_{HOT_SWAP(MAX)}$), which the circuit may let pass in the case of tolerance build-up in the opposite direction. Here, the worse-case maximum is found using a $V_{TRIP(MAX)}$ threshold of 55mV and a sense resistor 3% low in value:

$$I_{HOT_SWAP(MAX)} = \frac{55\text{mV}}{(0.97 \times R_{SENSE(NOM)})} = \frac{56.7\text{mV}}{R_{SENSE(NOM)}} \quad \text{Eq. 21}$$

In this case, the application circuit must be sturdy enough to operate over a ~1.5-to-1 range in hot swap load currents. For example, if an MIC2586 circuit must pass a minimum hot swap load current of 4A without nuisance trips, R_{SENSE} should be set to:

$$R_{SENSE(NOM)} = \frac{39\text{mV}}{4\text{A}} = 9.75\text{m}\Omega \quad \text{Eq. 22}$$

where the nearest 1% standard value is 9.76m Ω . At the other tolerance extremes, $I_{HOT_SWAP(MAX)}$ for the circuit in question is then simply:

$$I_{HOT_SWAP(MAX)} = \frac{56.7\text{mV}}{9.76\text{m}\Omega} = 5.8\text{A} \quad \text{Eq. 23}$$

With a knowledge of the application circuit's maximum hot swap load current, the power dissipation rating of the sense resistor can be determined using $P = I^2R$. Here, The current is $I_{HOT_SWAP(MAX)} = 5.8\text{A}$ and the resistance $R_{SENSE(MIN)} = (0.97)(R_{SENSE(NOM)}) = 9.47\text{m}\Omega$. Thus, the sense resistor's maximum power dissipation is:

$$P_{MAX} = (5.8\text{A})^2 \times (9.47\text{m}\Omega) = 0.319\text{W} \quad \text{Eq. 24}$$

A 0.5W sense resistor is a good choice in this application.

When the MIC2586/MIC2586R's foldback current limiting circuit is engaged in the above example, the current limit would nominally fold back to 1.23A when the output is shorted to ground.

PCB Layout Considerations

4-Wire Kelvin Sensing

Because of the low value typically required for the sense resistor, special care must be used to accurately measure the voltage drop across it. Specifically, the measurement technique across R_{SENSE} must employ 4-wire Kelvin sensing. This is simply a means of ensuring that any voltage drops in the power traces connected to the resistors are not picked up by the signal conductors measuring the voltages across the sense resistors.

Figure 8 illustrates how to implement 4-wire Kelvin sensing. As the figure shows, all the high current in the circuit (from V_{CC} through R_{SENSE} and then to the drain of the N-channel power MOSFET) flows directly through the power PCB traces and through R_{SENSE} .

The voltage drop across R_{SENSE} is sampled in such a way that the high currents through the power traces will not introduce significant parasitic voltage drops in the sense leads. It is recommended to connect the hot swap controller's sense leads directly to the sense resistor's metalized contact pads. The Kelvin sense signal traces should be symmetrical with equal length and width, kept as short as possible and isolated from any noisy signals and planes.

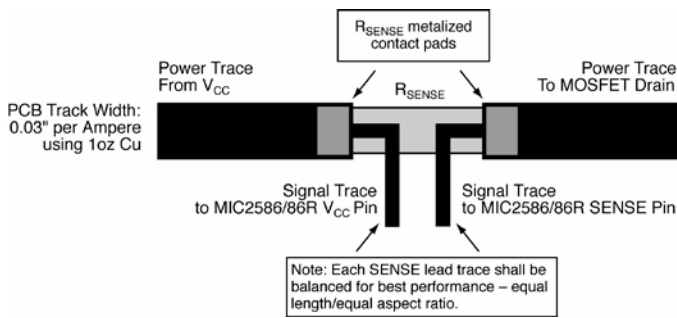

Figure 8. 4-Wire Kelvin Sense Connections for R_{SENSE}

Additionally, for designs that implement Kelvin sense connections that exceed 1" in length and/or if the Kelvin (signal) traces are vulnerable to noise possibly being injected onto these signals, the example circuit shown in Figure 9 can be implemented to combat noisy environments. This circuit implements a 1.6 MHz low-pass filter to attenuate higher frequency disturbances on the current sensing circuitry. However, individual system analysis should be used to determine if filtering is necessary and to select the appropriate cutoff frequency for each specific application.

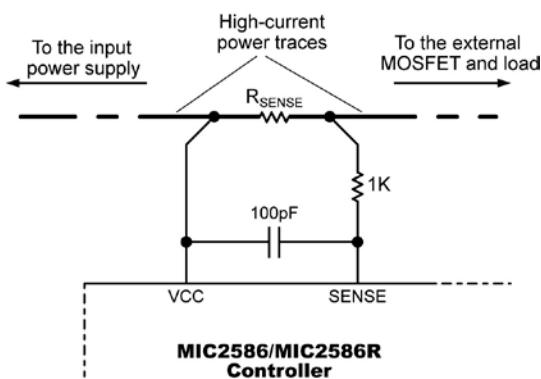

Figure 9. Current-Limit Sense Filter for Noisy Systems

Other Layout Considerations

Figure 10 is a recommended PCB layout diagram for the MIC2586-2BM. Many hot swap applications will require load currents of several amperes. Therefore, the power (V_{CC} and Return) trace widths (W) need to be wide enough to allow the current to flow while the rise in temperature for a given copper plate (e.g., 1oz. or 2oz.) is kept to a maximum of 10°C to 25°C. Also, these traces should be as short as possible in order to minimize the IR drops between the input and the load. The feedback network resistor values in Figure 10 are selected for a +24V application. The resistors for the feedback (FB) and ON pin networks should be placed close to the controller and the associated traces should be as short as possible to improve the circuit's noise immunity. The input "clamping diode" (D1) is referenced in the typical application circuit. If possible, use high-frequency PCB layout techniques around the GATE circuitry (shown in the typical application circuit) and use a dummy resistor (e.g., $R_3 = 0\Omega$) during the prototype phase. If R_3 is needed to eliminate high-frequency oscillations, common values for R_3 range between 4.7Ω to 20Ω for various power MOSFETs. Finally, the use of plated-through vias will be needed to make circuit connection to the power and ground planes when utilizing multi-layer PCBs.

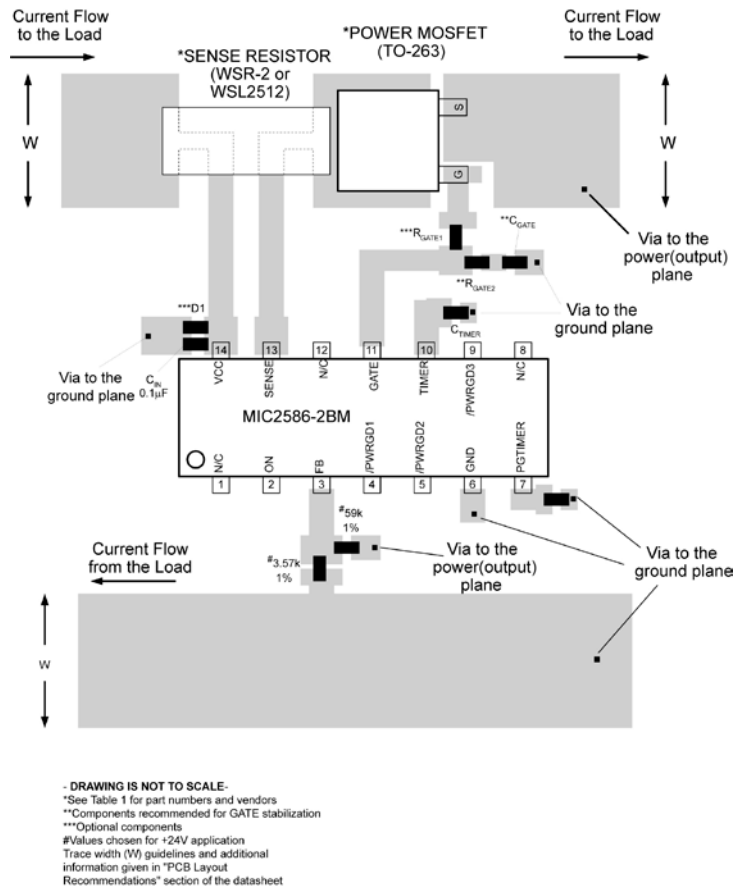

Figure 10. Recommended PCB Layout for Sense Resistor, Power MOSFET, Timer, and Feedback Network

MOSFET and Sense Resistor Vendors

Device types, part numbers, and manufacturer contacts for power MOSFETs and sense resistors are provided in Table 1 and Table 2.

MOSFET Vendor	Key MOSFET Type(s)	Breakdown Voltage (V_{DSS})	Contact Information
Vishay – Siliconix	SUM75N06-09L (TO-263) SUM70N06-11 (TO-263) SUM50N06-16L (TO-263)	60V 60V 60V	www.siliconix.com (203) 452-5664
International Rectifier	SUP85N10-10 (TO-220AB) SUB85N10-10 (TO-263) SUM110N10-09 (TO-263) SUM60N10-17 (TO-263)	100V 100V 100V 100V	www.siliconix.com (203) 452-5664
Renesas	IRF530 (TO-220AB) IRF540N (TO-220AB)	100V 100V	www.irf.com (310) 322-3331

Table 1. MOSFET Vendors

Resistor Vendors	Sense Resistors	Contact Information
Vishay - Dale	“WSL” and “WSR” Series	www.vishay.com/docswsl_30100.pdf (203) 452-5664
IRC	“OARS” Series “LR” Series Second source to “WSL”	www.irctt.com/pdf_files/OARS.pdf www.irctt.com/pdf_files/LRC.pdf (828) 264-8861

Table 2. Sense Resistor Vendors

Package Information⁽¹⁾

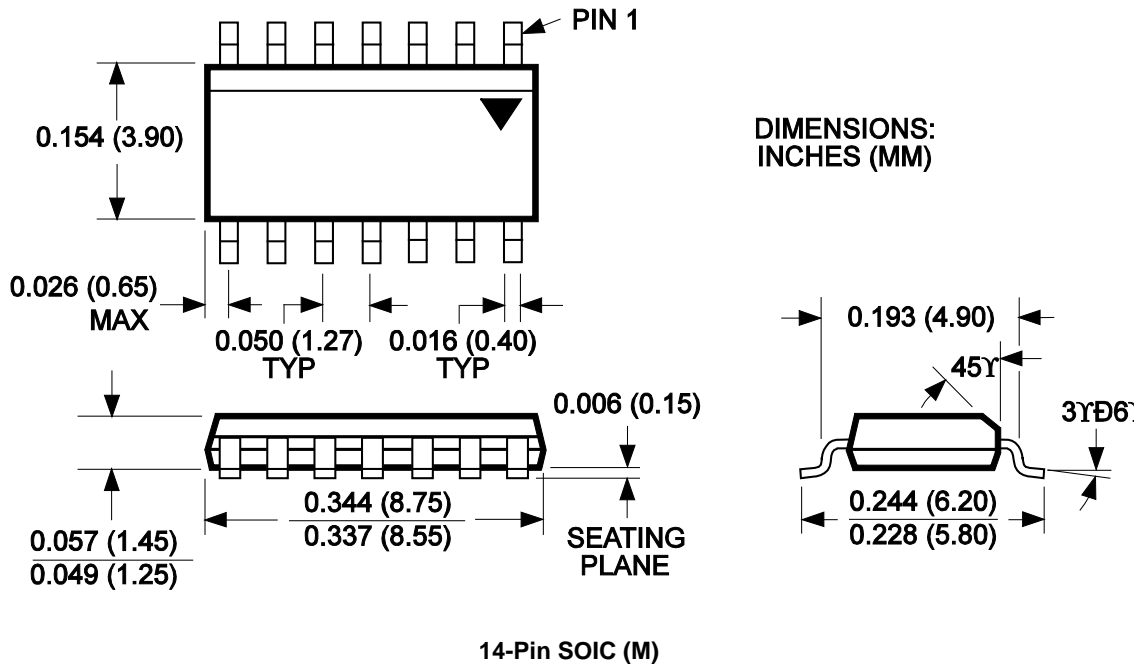

Note:

1. Package information is correct as of the publication date. For updates and most current information, go to www.micrel.com.

MICREL, INC. 2180 FORTUNE DRIVE SAN JOSE, CA 95131 USA
 TEL +1 (408) 944-0800 FAX +1 (408) 474-1000 WEB <http://www.micrel.com>

Micrel makes no representations or warranties with respect to the accuracy or completeness of the information furnished in this data sheet. This information is not intended as a warranty and Micrel does not assume responsibility for its use. Micrel reserves the right to change circuitry, specifications and descriptions at any time without notice. No license, whether express, implied, arising by estoppel or otherwise, to any intellectual property rights is granted by this document. Except as provided in Micrel's terms and conditions of sale for such products, Micrel assumes no liability whatsoever, and Micrel disclaims any express or implied warranty relating to the sale and/or use of Micrel products including liability or warranties relating to fitness for a particular purpose, merchantability, or infringement of any patent, copyright or other intellectual property right.

Micrel Products are not designed or authorized for use as components in life support appliances, devices or systems where malfunction of a product can reasonably be expected to result in personal injury. Life support devices or systems are devices or systems that (a) are intended for surgical implant into the body or (b) support or sustain life, and whose failure to perform can be reasonably expected to result in a significant injury to the user. A Purchaser's use or sale of Micrel Products for use in life support appliances, devices or systems is a Purchaser's own risk and Purchaser agrees to fully indemnify Micrel for any damages resulting from such use or sale.

© 2004 Micrel, Incorporated.

Looking for pricing, stock, or lifecycle information?

Click below to explore more details on WIN SOURCE:

- ⊖ [View MIC2586R-1YM on WIN SOURCE](#)
- ⊖ [Microchip Technology](#) Information

Optimize Your Supply Chain with WIN SOURCE Solutions

- ✓ Global Sourcing Solution
- ✓ Obsolete Management
- ✓ Cost Control Management
- ✓ Shortage Management
- ✓ Alternative Solution
- ✓ Excess Inventory Management