



**THE DATASHEET OF
LQP03TG39NJ02D**



Customer Part Number	MURATA Part Number	Inductance		Q (min)	DC Resistance (Ω max)	Self Resonant Frequency (MHz)		Rated Current (mA)
		(nH)	Tolerance			Min.	*Typ.	
	LQP03TG2N0B02D	2.0	B:±0.1nH C:±0.2nH	13	0.25	12500	14800	450
	LQP03TG2N0C02D							
	LQP03TG2N1B02D	2.1				12000	14300	
	LQP03TG2N1C02D							
	LQP03TG2N2B02D	2.2				11500	14100	
	LQP03TG2N2C02D							
	LQP03TG2N3B02D	2.3				11000	13700	
	LQP03TG2N3C02D							
	LQP03TG2N4B02D	2.4				11000	13800	
	LQP03TG2N4C02D							
	LQP03TG2N5B02D	2.5				11000	13900	
	LQP03TG2N5C02D							
	LQP03TG2N6B02D	2.6		11000	13100			
	LQP03TG2N6C02D							
	LQP03TG2N7B02D	2.7		12200	11500			
	LQP03TG2N7C02D							
	LQP03TG2N8B02D	2.8		11800	11600			
	LQP03TG2N8C02D							
	LQP03TG2N9B02D	2.9		11200	11200			
	LQP03TG2N9C02D							
	LQP03TG3N0B02D	3.0		9500	11800			
	LQP03TG3N0C02D							
	LQP03TG3N1B02D	3.1		0.32	11600			
	LQP03TG3N1C02D							
	LQP03TG3N2B02D	3.2	0.32	11200				
	LQP03TG3N2C02D							
	LQP03TG3N3B02D	3.3	0.35	10300				
	LQP03TG3N3C02D							
	LQP03TG3N4B02D	3.4	0.35	10000				
	LQP03TG3N4C02D							
	LQP03TG3N5B02D	3.5	0.35	9400				
	LQP03TG3N5C02D							
	LQP03TG3N6B02D	3.6	0.35	8600				
	LQP03TG3N6C02D							
	LQP03TG3N7B02D	3.7	0.35	8100				
	LQP03TG3N7C02D							
	LQP03TG3N8B02D	3.8	0.58	8000				
	LQP03TG3N8C02D							
	LQP03TG3N9B02D	3.9	0.58	8000				
	LQP03TG3N9C02D							
	LQP03TG4N3H02D	4.3	0.72	7800				
	LQP03TG4N3J02D							
	LQP03TG4N7H02D	4.7	0.72	7500				
	LQP03TG4N7J02D							
	LQP03TG5N1H02D	5.1	0.88	7400				
	LQP03TG5N1J02D							
	LQP03TG5N6H02D	5.6	1.15	6300				
	LQP03TG5N6J02D							
	LQP03TG6N2H02D	6.2	1.15	6300				
	LQP03TG6N2J02D							
	LQP03TG6N8H02D	6.8	1.22	5600				
	LQP03TG6N8J02D							
	LQP03TG7N5H02D	7.5	1.22	5600				
	LQP03TG7N5J02D							
	LQP03TG6N2H02D	6.2	H:±3% J:±5%	12	0.72	7800	250	
	LQP03TG6N2J02D							
	LQP03TG6N8H02D	6.8	H:±3% J:±5%	12	0.88	7500	200	
	LQP03TG6N8J02D							
	LQP03TG7N5H02D	7.5	H:±3% J:±5%	12	1.15	7400	200	
	LQP03TG7N5J02D							

Customer Part Number	MURATA Part Number	Inductance		Q (min)	DC Resistance (Ω max)	Self Resonant Frequency (MHz)		Rated Current (mA)									
		(nH)	Tolerance			Min.	*Typ.										
	LQP03TG8N2H02D	8.2	H:±3% J:±5%	12	1.40	4800	6200	200									
	LQP03TG8N2J02D																
	LQP03TG9N1H02D	9.1		H:±3% J:±5%	11	1.52	4500	5200	190								
	LQP03TG9N1J02D																
	LQP03TG10NH02D	10			H:±3% J:±5%	11	1.65	4100	4700	180							
	LQP03TG10NJ02D																
	LQP03TG11NH02D	11				H:±3% J:±5%	11	1.78	3700	4400	170						
	LQP03TG11NJ02D																
	LQP03TG12NH02D	12					H:±3% J:±5%	11	1.82	3400	3800	170					
	LQP03TG12NJ02D																
	LQP03TG13NH02D	13	H:±3% J:±5%					11	1.90	3100	3600	160					
	LQP03TG13NJ02D																
	LQP03TG15NH02D	15						H:±3% J:±5%	11	2.03	2900	3300	160				
	LQP03TG15NJ02D																
	LQP03TG16NH02D	16		H:±3% J:±5%					11	2.28	2800	3200	140				
	LQP03TG16NJ02D																
	LQP03TG18NH02D	18			H:±3% J:±5%				9	2.57	2600	2900	140				
	LQP03TG18NJ02D																
	LQP03TG20NH02D	20							H:±3% J:±5%	9	2.85	2500	2900	120			
	LQP03TG20NJ02D																
	LQP03TG22NH02D	22				H:±3% J:±5%				7	3.17	2000	2400	110			
	LQP03TG22NJ02D																
	LQP03TG24NH02D	24					H:±3% J:±5%			7	3.65	1700	2200	100			
	LQP03TG24NJ02D																
	LQP03TG27NH02D	27								H:±3% J:±5%	7	4.25	1600	2000	90		
	LQP03TG27NJ02D																
	LQP03TG33NJ02D	33	H:±3% J:±5%								6	4.60	1500	1700	80		
	LQP03TG39NJ02D																
	LQP03TG47NJ02D	47						H:±3% J:±5%			6	5.20	1300	1500	90		
	LQP03TG56NJ02D																
	LQP03TG68NJ02D	68									H:±3% J:±5%	6	5.60	1200	1400	90	
	LQP03TG82NJ02D																
	LQP03TGR10J02D	100		H:±3% J:±5%								6	6.25	1100	1300	80	
	LQP03TGR12J02D	120															
					H:±3% J:±5%							6	7.15	1000	1200	80	
												H:±3% J:±5%	6	8.05	900	1000	80
									H:±3% J:±5%				6	8.75	800	1000	80

* Typical value is actual performance.

4. Testing Conditions

《Unless otherwise specified》

Temperature : Ordinary Temperature / 15°C to 35°C
 Humidity : Ordinary Humidity / 25%(RH) to 85 %(RH)

《In case of doubt》

Temperature : 20°C ± 2°C
 Humidity : 60%(RH) to 70 %(RH)
 Atmospheric Pressure : 86kPa to 106 kPa

5. Appearance and Dimensions

(0.1nH to 0.5nH)

(0.6nH to 120nH)

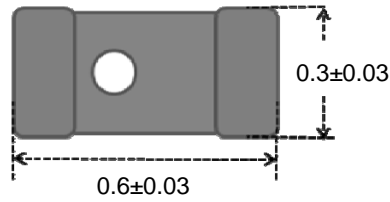
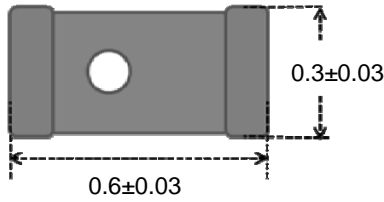

■ Unit Mass (Typical value)
 0.0002g

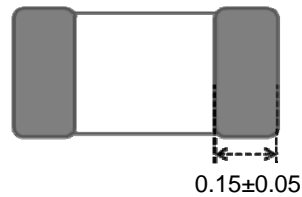
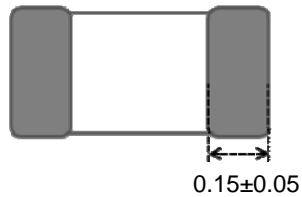
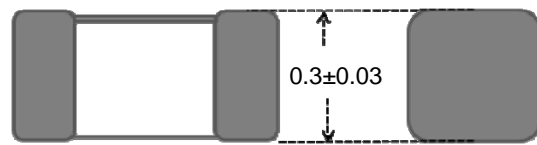
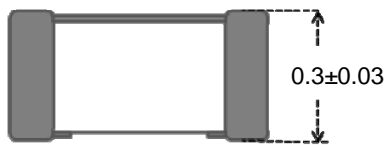

(in mm)

6. Marking

Polarity Marking :white

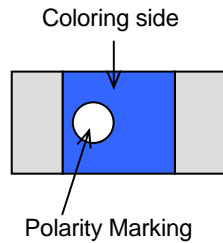

7. Electrical Performance

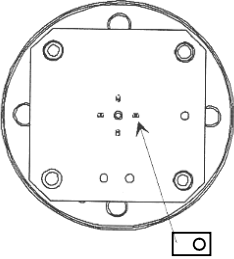
No.	Item	Specification	Test Method
7.1	Inductance	Inductance shall meet item 3.	<p>Measuring Equipment: KEYSIGHT E4991A or equivalent</p> <p>Measuring Frequency: (0.1nH~27nH) 500MHz (33nH~120nH) 300MHz</p> <p>Measuring Condition: Test signal level / about 0dBm Electrical length / 10mm</p> <p>Measuring Fixture: KEYSIGHT 16197A Position coil under test as shown in below and contact coil with each terminal by adding weight. Coloring side should be a topside, and should be in the direction of the fixture for position of chip coil.</p>  <p style="text-align: center;">↑ Polarity Marking</p>
7.2	Q	Q shall meet item 3.	<p>Measuring Method: See P.12 <Electrical Performance: Measuring Method of Inductance/Q></p>
7.3	DC Resistance	DC Resistance shall meet item 3.	Measuring Equipment: Digital multi meter
7.4	Self Resonant Frequency(S.R.F)	S.R.F shall meet item 3.	Measuring Equipment: KEYSIGHT 8753C or equivalent
7.5	Rated Current	Self temperature rise shall be limited to 25°C max.	The rated current is applied.

8.Mechanical Performance

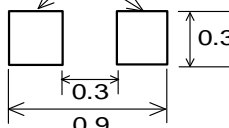
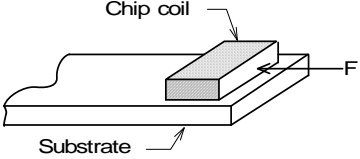
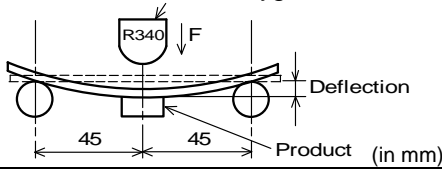
No.	Item	Specification	Test Method
8.1	Shear Test	Chip coil shall not be damaged after tested as test method.	Substrate:Glass-epoxy substrate Land  Force:2N Hold Duration:5 s±1 s Applied Direction: Parallel to PCB. Chip coil  Substrate
8.2	Bending Test	Chip coil shall not be damaged after tested as test method.	Substrate:Glass-epoxy substrate (100mm × 40mm × 0.8mm) Speed of Applying Force:1mm /s Deflection:1mm Hold Duration:30 s Pressure jig  Deflection Product (in mm)
8.3	Vibration	Appearance:No damage Inductance Change: within ±10%	Substrate: Glass-epoxy substrate Oscillation Frequency: 10Hz to 2000Hz to 10Hz for 20 min Total amplitude 1.5 mm or Acceleration amplitude 196 m/s ² whichever is smaller. Testing Time: A period of 2h in each of 3 mutually perpendicular directions.
8.4	Solderability	The electrode shall be at least 90% covered with new solder coating.	Flux: Ethanol solution of rosin 25(wt)% (Immersed for 5s to 10s) Solder:Sn-3.0Ag-0.5Cu Pre-Heating:150°C±10°C / 60s to 90s Solder Temperature:240°C±5°C Immersion Time:3s±1s
8.5	Resistance to Soldering Heat	Appearance:No damage Inductance Change: within ±10%	Flux: Ethanol solution of rosin 25(wt)% (Immersed for 5s to 10s) Solder:Sn-3.0Ag-0.5Cu Pre-Heating:150°C±10°C / 60s to 90s Solder Temperature:260°C±5°C Immersion Time:5s±1s Then measured after exposure in the room condition for 24h±2h.

9.Environmental Performance

It shall be soldered on the substrate.

No.	Item	Specification	Test Method
9.1	Heat Resistance	Appearance:No damage Inductance Change: within $\pm 10\%$	Substrate: Glass-epoxy substrate Temperature:125°C Time:1000h (+48h,-0h) Then measured after exposure in the room condition for 24h \pm 2h.
9.2	Cold Resistance		Substrate: Glass-epoxy substrate Temperature:-55°C Time:1000 h (+48h,-0h) Then measured after exposure in the room condition for 24h \pm 2h.
9.3	Humidity		Substrate: Glass-epoxy substrate Temperature:40°C \pm 2°C Humidity:90%(RH) to 95%(RH) Time:1000 h(+48h,-0h) Then measured after exposure in the room condition for 24h \pm 2h.
9.4	Temperature Cycle		Substrate: Glass-epoxy substrate 1 cycle: 1 step: -55°C / 30min \pm 3 min 2 step: Ordinary temp. / 10~15 min 3 step: 125°C / 30min \pm 3 min 4 step: Ordinary temp. / 10~15 min Total of 10 cycles Then measured after exposure in the room condition for 24h \pm 2h.

10.Specification of Packaging

10.1 Appearance and Dimensions of paper tape (8mm-wide)

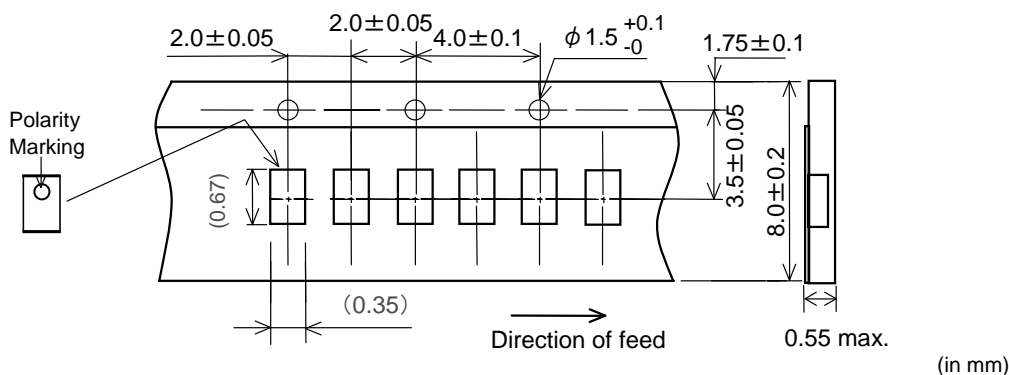

10.2 Specification of Taping

- (1) Packing quantity (standard quantity)
15,000 pcs. / reel
- (2) Packing Method
Products shall be packed in the cavity of the base tape and sealed by cover tape.
- (3) Sprocket hole
Sprocket hole shall be located on the left-hand side toward the direction of feed.
- (4) Spliced point
Base tape and Cover tape has no spliced point.
- (5) Missing components number
Missing components number within 0.1 % of the number per reel or 1 pc. , whichever is greater, and are not continuous. The Specified quantity per reel is kept.

10.3 Pull Strength

Cover tape	5N min
------------	--------

10.4 Peeling off force of cover tape

Speed of Peeling off	300mm/min
Peeling off force	0.1N to 0.6N (minimum value is typical)

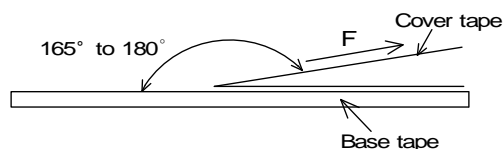

10.5 Dimensions of Leader-tape, Trailer and Reel

There shall be leader-tape (top tape and empty tape) and trailer-tape (empty tape) as follows.

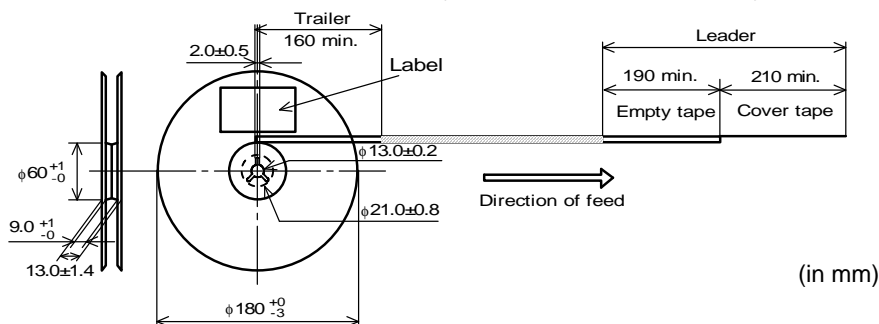

10.6 Marking for reel

Customer part number, MURATA part number, Inspection number(*1) , RoHS Marking (*2), Quantity etc ...

*1) <Expression of Inspection No.>

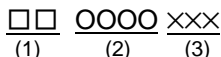

- (1) Factory Code
- (2) Date

First digit : Year / Last digit of year
 Second digit : Month / Jan. to Sep. → 1 to 9, Oct. to Dec. → O,N,D
 Third, Fourth digit : Day

- (3) Serial No.

*2) <Expression of RoHS Marking >

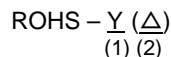

- (1) RoHS regulation conformity parts.
- (2) MURATA classification number

10.7 Marking for Outside package (corrugated paper box)

Customer name, Purchasing order number, Customer part number, MURATA part number, RoHS Marking (*2) ,Quantity, etc ...

10.8 Specification of Outer Case

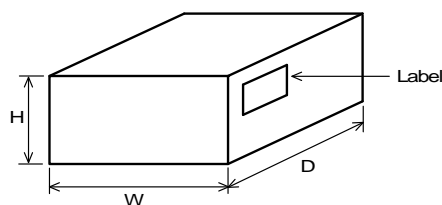

Outer Case Dimensions (mm)			Standard Reel Quantity in Outer Case (Reel)
W	D	H	
186	186	93	5

* Above Outer Case size is typical. It depends on a quantity of an order.

11. ⚠ Caution

Limitation of Applications

Please contact us before using our products for the applications listed below which require especially high reliability for the prevention of defects which might directly cause damage to the third party's life, body or property.

- | | |
|-----------------------------------|--|
| (1) Aircraft equipment | (6) Transportation equipment (vehicles, trains, ships, etc.) |
| (2) Aerospace equipment | (7) Traffic signal equipment |
| (3) Undersea equipment | (8) Disaster prevention / crime prevention equipment |
| (4) Power plant control equipment | (9) Data-processing equipment |
| (5) Medical equipment | (10) Applications of similar complexity and /or reliability requirements to the applications listed in the above |

12. Notice

Products can only be soldered with reflow.

This product is designed for solder mounting.

Please consult us in advance for applying other mounting method such as conductive adhesive.

12.1 Land pattern designing

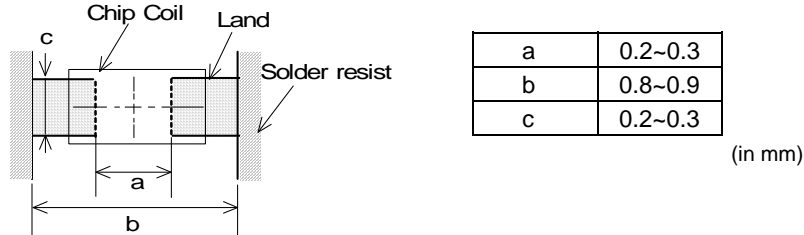

12.2 Flux, Solder

- Use rosin-based flux.
Don't use highly acidic flux with halide content exceeding 0.2(wt)% (chlorine conversion value).
Don't use water-soluble flux.
- Use Sn-3.0Ag-0.5Cu solder.
- Standard thickness of solder paste : 100 μm~150 μm.

12.3 Reflow soldering conditions

- Pre-heating should be in such a way that the temperature difference between solder and product surface is limited to 150°C max. Cooling into solvent after soldering also should be in such a way that the temperature difference is limited to 100°C max. Insufficient pre-heating may cause cracks on the product, resulting in the deterioration of products quality.
- Standard soldering profile and the limit soldering profile is as follows.
The excessive limit soldering conditions may cause leaching of the electrode and / or resulting in the deterioration of product quality.
- Reflow soldering profile

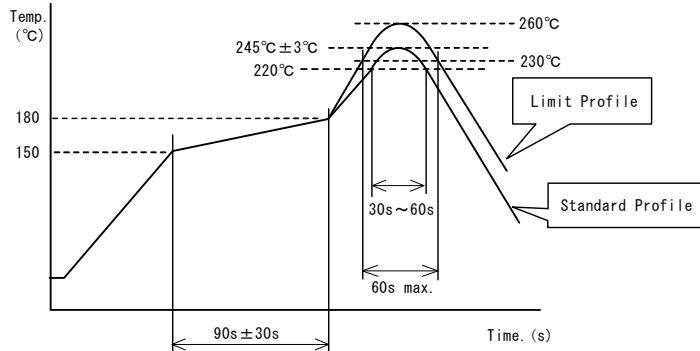

	Standard Profile	Limit Profile
Pre-heating	150°C~180°C , 90s±30s	
Heating	above 220°C, 30s~60s	above 230°C, 60s max.
Peak temperature	245°C±3°C	260°C, 10s
Cycle of reflow	2 times	

12.4 Reworking with soldering iron

The following conditions must be strictly followed when using a soldering iron.

Pre-heating	150°C, 1 min
Tip temperature	350°C max.
Soldering iron output	80W max.
Tip diameter	φ 3mm max.
Soldering time	3(+1,-0)s
Time	2 times

Note : Do not directly touch the products with the tip of the soldering iron in order to prevent the crack on the products due to the thermal shock.

12.5 Solder Volume

- Solder shall be used not to be exceeded the upper limits as shown below.

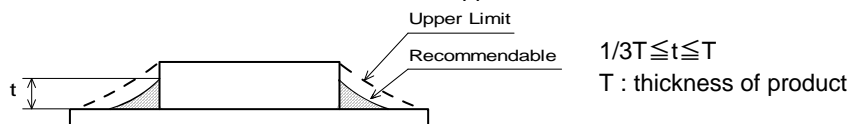

Accordingly increasing the solder volume, the mechanical stress to Chip is also increased. Exceeding solder volume may cause the failure of mechanical or electrical performance.

12.6 Attention regarding P.C.B. bending

The following shall be considered when designing and laying out P.C.B.'s.

- P.C.B. shall be designed so that products are not subject to the mechanical stress due to warping the board.

[Products direction]

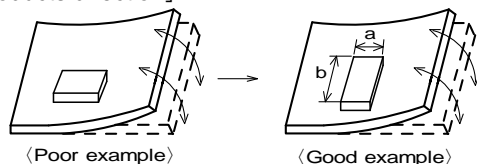

Products shall be located in the sideways direction (Length: $a < b$) to the mechanical stress.

- Products location on P.C.B. separation

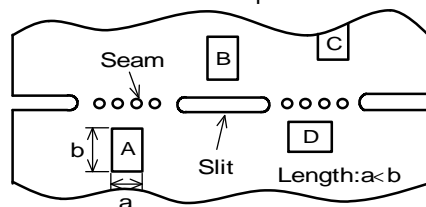

Products (A,B,C,D) shall be located carefully so that products are not subject to the mechanical stress due to warping the board. Because they may be subjected the mechanical stress in order of $A > C > B \cong D$.

12.7 Cleaning Conditions

Products shall be cleaned on the following conditions.

- Cleaning temperature shall be limited to 60°C max. (40°C max for IPA)
- Ultrasonic cleaning shall comply with the following conditions with avoiding the resonance phenomenon at the mounted products and P.C.B.
 - Power : 20 W / l max. Frequency : 28kHz to 40kHz Time : 5 min max.
- Cleaner
 - Alcohol type cleaner
Isopropyl alcohol (IPA)
 - Aqueous agent
PINE ALPHA ST-100S
- There shall be no residual flux and residual cleaner after cleaning.
 - In the case of using aqueous agent, products shall be dried completely after rinse with de-ionized water in order to remove the cleaner.
- Other cleaning Please contact us.

12.8 Resin coating

When products are coated with resin, please contact us in advance.

12.9 Handling of a substrate

- (1) There is a possibility of chip cracking caused by PCB expansion/contraction with heat, because stress on a chip is different depending on PCB material and structure.
When the thermal expansion coefficient greatly differs between the board used for mounting and the chip, it will cause cracking of the chip due to the thermal expansion and contraction.
The chip is assumed to be mounted on the PCB of glass-epoxy material, and we don't test with other PCB material which has different thermal expansion coefficient from Glass-epoxy.
When other PCB materials are considered, please be sure to evaluate by yourself.
- (2) After mounting products on a substrate, do not apply any stress to the product caused by bending or twisting to the substrate when cropping the substrate, inserting and removing a connector from the substrate or tightening screw to the substrate.
Excessive mechanical stress may cause cracking in the product.
In case of the mounting on flexible PCB, there is a possibility of chip cracking caused by mechanical stress even from small bending or twisting.
When the flexible PCB is considered, please be sure to evaluate by yourself.

Bending

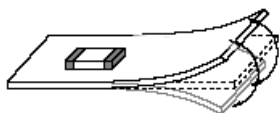

Twisting

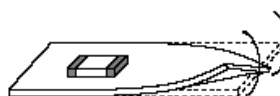

12.10 Storage and Handling Requirements

- (1) Storage period
Use the products within 12 months after delivered.
Solderability should be checked if this period is exceeded.
- (2) Storage conditions
• Products should be stored in the warehouse on the following conditions.
Temperature : -10°C ~ 40°C
Humidity : 15% to 85% relative humidity No rapid change on temperature and humidity.
• Products should not be stored on bulk packaging condition to prevent the chipping of the core and the breaking of winding wire caused by the collision between the products.
• Products should be stored on the palette for the prevention of the influence from humidity, dust and so on.
• Products should be stored in the warehouse without heat shock, vibration, direct sunlight and so on.
- (3) Handling Condition
Care should be taken when transporting or handling product to avoid excessive vibration or mechanical shock.

13. ⚠ Note

- (1) Please make sure that your product has been evaluated in view of your specifications with our product being mounted to your product.
- (2) You are requested not to use our product deviating from the reference specifications.
- (3) The contents of this reference specification are subject to change without advance notice.
Please approve our product specifications or transact the approval sheet for product specifications before ordering.

<Electrical Performance:Measuring Method of Inductance/Q>

(1) Residual elements and stray elements of test fixture can be described by F-parameter shown in following.

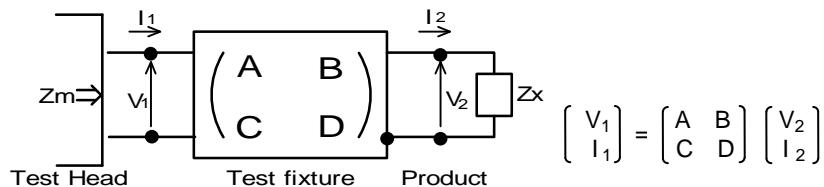

(2) The impedance of chip coil Z_x and measured value Z_m can be described by input/output current/voltage.

$$Z_m = \frac{V_1}{I_1} \quad , \quad Z_x = \frac{V_2}{I_2}$$

(3) Thus, the relation between Z_x and Z_m is following;

$$Z_x = \alpha \frac{Z_m - \beta}{1 - Z_m \Gamma} \quad \text{where, } \alpha = D / A = 1$$

$$\beta = B / D = Z_{sm} - (1 - Y_{om} Z_{sm}) Z_{ss}$$

$$\Gamma = C / A = Y_{om}$$

Z_{sm} :measured impedance of short chip
 Z_{ss} :residual impedance of short chip(0nH)
 Y_{om} :measured admittance when opening the fixture

(4) L_x and Q_x shall be calculated with the following equation.

$$L_x = \frac{\text{Im}(Z_x)}{2 \pi f} \quad , \quad Q_x = \frac{\text{Im}(Z_x)}{\text{Re}(Z_x)}$$

L_x :Inductance of chip coil
 Q_x :Q of chip coil
 f :Measuring frequency

Looking for pricing, stock, or lifecycle information?

Click below to explore more details on WIN SOURCE:

- ⊖ [View LQP03TG39NJ02D on WIN SOURCE](#)
- ⊖ [Murata Electronics North America Information](#)

Optimize Your Supply Chain with WIN SOURCE Solutions

- ✓ Global Sourcing Solution
- ✓ Obsolete Management
- ✓ Cost Control Management
- ✓ Shortage Management
- ✓ Alternative Solution
- ✓ Excess Inventory Management