



**THE DATASHEET OF
CPDV3-5V0U-HF**



CPDV3-5V0U-HF

RoHS Device
Halogen Free

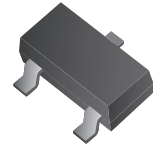

Features

- IEC61000-4-2 Level 4 ESD protection.
- Surface mount package.
- High component density.

Mechanical data

- Case: SOT-323 Standard package, molded plastic.
- Terminals: Solderable per MIL-STD-750, method 2026.
- Marking code: E5U
- Mounting position: Any.
- Weight: 0.0055 gram (approx.).

Circuit diagram

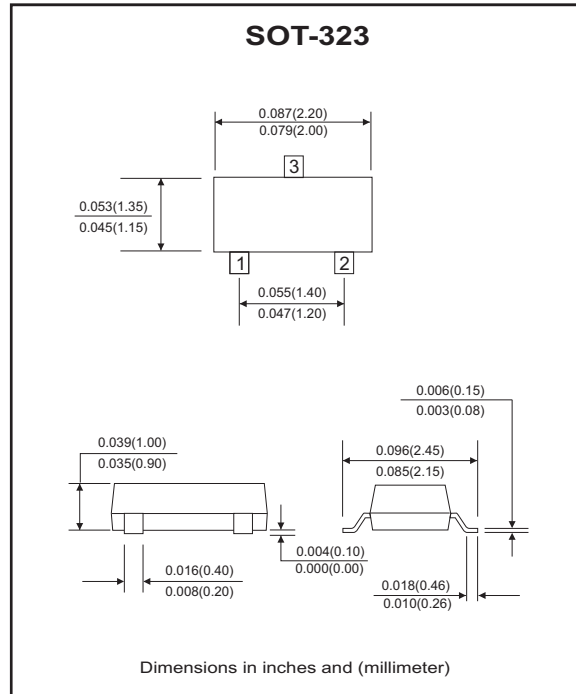
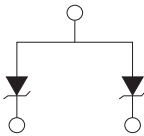

Maximum Rating and Electrical Characteristics

(at TA=25°C unless otherwise noted)

Parameter	Symbol	Conditions	Min	Typ	Max	Unit
Diode breakdown voltage	V _{BD}	I _R = 1mA	6.1			V
Leakage current	I _L	V _R = 3V		0.1	1.0	uA
Forward voltage	V _F	I _F = 10mA			1.2	V
Junction capacitance	C _T	V _R = 0V, f = 1MHz		60	80	pF
ESD capability	ESD	IEC 61000-4-2(air) IEC 61000-4-2(contact)			15 8	kV
Clamping voltage	V _C	I _{PP} = 1A, T _P =8/20us I _{PP} = 8A, T _P =8/20us			8 10	V
Peak pulse power	P _{PP}				80	W
Operation temperature	T _J				125	°C
Storage temperature	T _{STG}		-55		150	°C

RATING AND CHARACTERISTIC CURVES (CPDV3-5V0U-HF)

Fig. 1 - 8/20us Peak pulse current waveform acc. IEC 61000-4-5

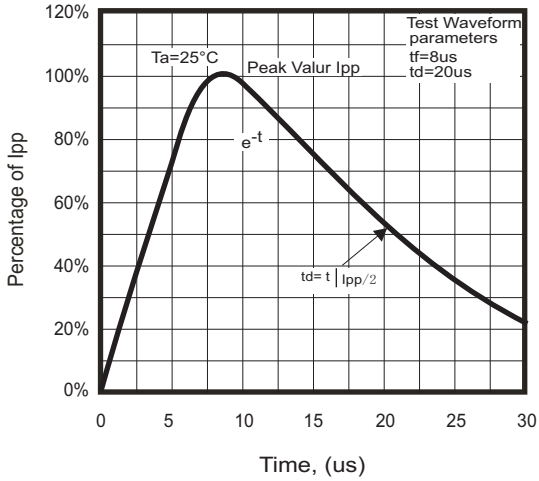

Fig. 2 - Power rating derating curve

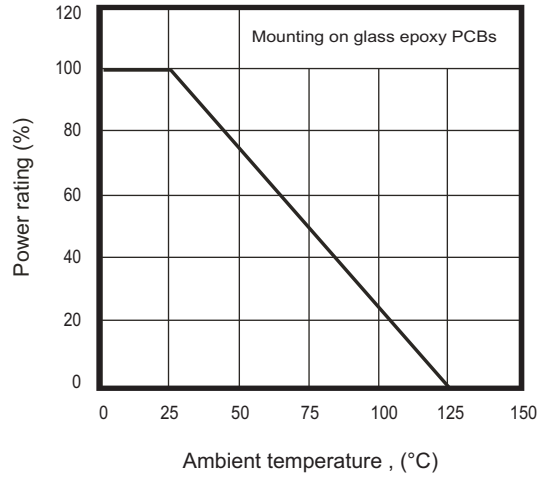

Fig. 3 - Clamping voltage vs. peak pulse current

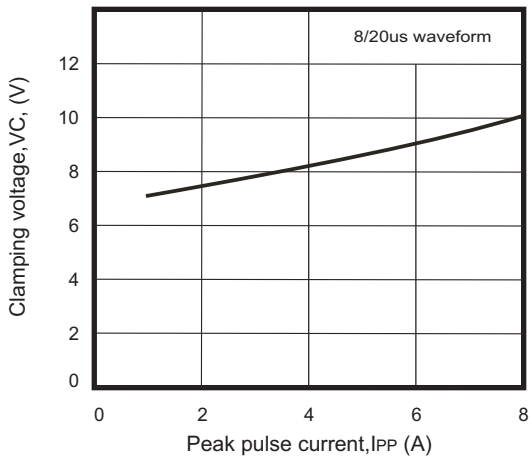
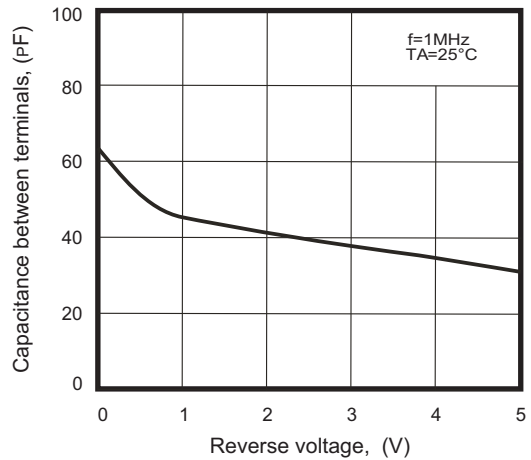
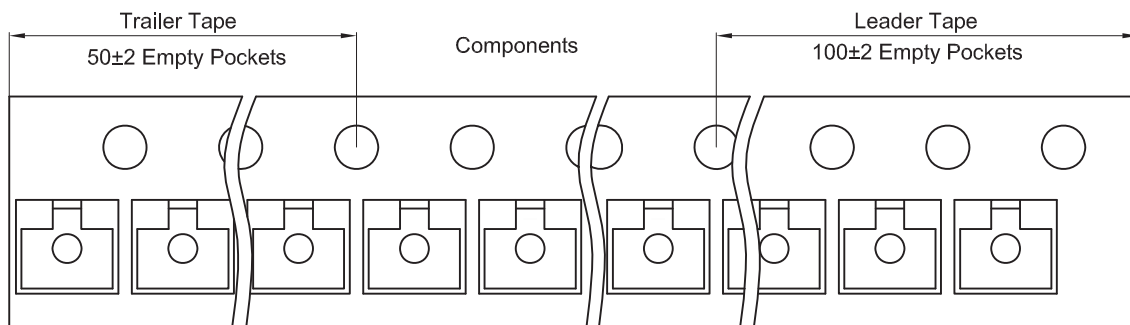
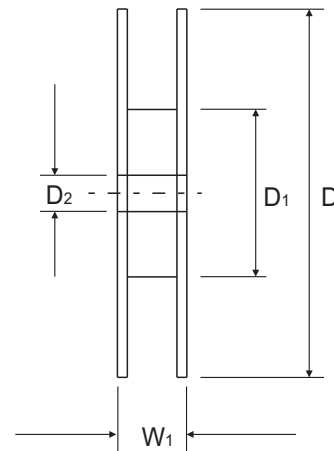
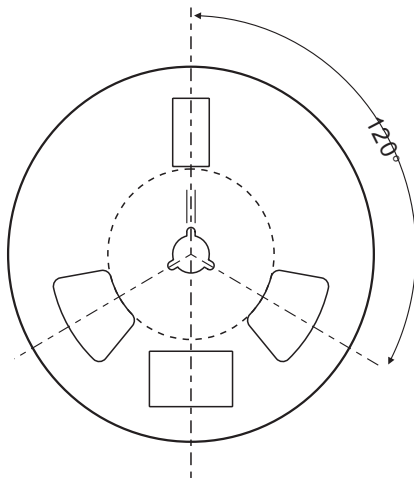
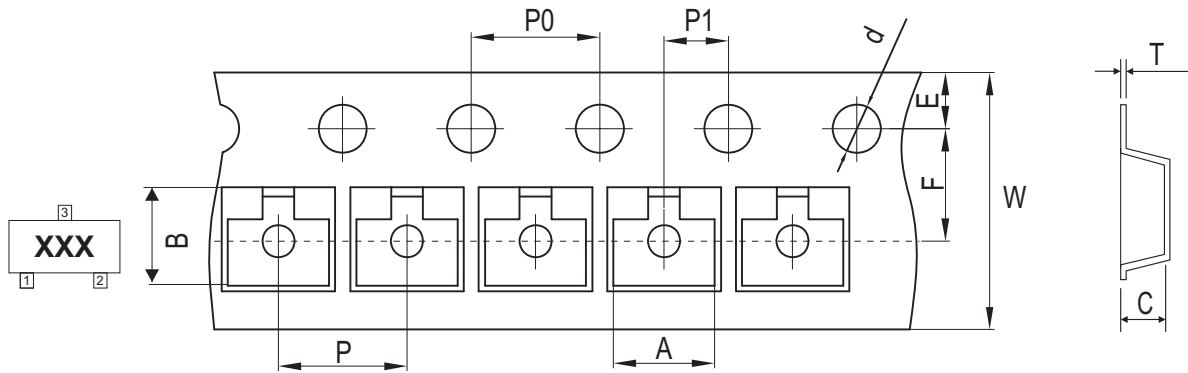

Fig. 4 - Capacitance between terminals characteristics



Reel Taping Specification



SOT-323	SYMBOL	A	B	C	d	D	D1	D2
	(mm)	2.25 ± 0.05	2.55 ± 0.05	1.19 ± 0.05	1.55 ± 0.10	178 ± 2.00	54.40 ± 1.00	13.00 ± 1.00
	(inch)	0.089 ± 0.002	0.100 ± 0.002	0.047 ± 0.002	0.061 ± 0.004	7.008 ± 0.079	2.142 ± 0.039	0.512 ± 0.039

SOT-323	SYMBOL	E	F	P	P0	P1	W	W1
	(mm)	1.75 ± 0.10	3.50 ± 0.10	4.00 ± 0.10	4.00 ± 0.10	2.00 ± 0.10	8.00 + 0.30 / - 0.10	12.30 ± 1.00
	(inch)	0.069 ± 0.004	0.138 ± 0.004	0.157 ± 0.004	0.157 ± 0.004	0.079 ± 0.004	0.315 + 0.012 / - 0.004	0.484 ± 0.039

Marking Code

Part Number	Marking Code
CPDV3-5V0U-HF	E5U

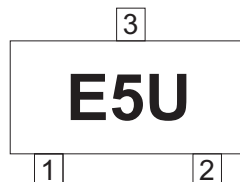

Suggested PAD Layout

SIZE	SOT-323	
	(mm)	(inch)
A	0.80	0.031
B	0.50	0.020
C	1.30	0.051
D	2.20	0.087

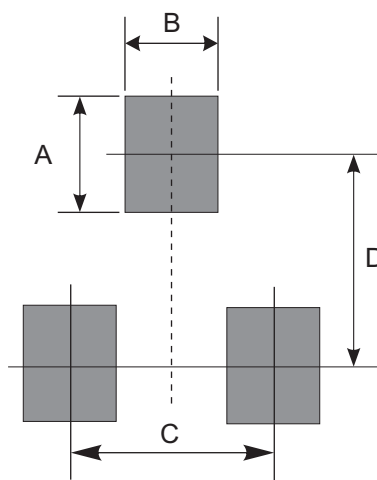



Standard Packaging

Case Type	REEL PACK	
	REEL (pcs)	Reel Size (inch)
SOT-323	3,000	7

Looking for pricing, stock, or lifecycle information?

Click below to explore more details on WIN SOURCE:

-  [View CPDV3-5V0U-HF on WIN SOURCE](#)
-  [Comchip Technology Information](#)

Optimize Your Supply Chain with WIN SOURCE Solutions

-  Global Sourcing Solution
-  Obsolete Management
-  Cost Control Management
-  Shortage Management
-  Alternative Solution
-  Excess Inventory Management