



250 MHz QAM IF DOWNCONVERTER

UPC2798GR

FEATURES

- **RF/LO FREQUENCY RANGE: 30-250 MHz**
- **ON CHIP VCO**
- **LOW DISTORTION AGC AMPLIFIER:**
-9 dBm IIP₃ @ MIN Gain
- **ON CHIP VIDEO AMP: 3.0 V_{p-p} (V_{CC} = 5 V)**
- **SMALL 20 PIN SSOP PACKAGE**
- **AVAILABLE ON TAPE AND REEL**

DESCRIPTION

NEC's UPC2798GR is a Silicon MMIC Downconverter manufactured with the NESAT™III silicon bipolar process. This product consists of an input AGC amplifier, mixer, local oscillator, and video amplifier. It is housed in a small 20 pin SSOP package. The device is designed for use as an IF downconverter for digital CATV settops and cable modems utilizing QAM modulation.

NEC's stringent quality assurance and test procedures ensure the highest reliability and performance.

ELECTRICAL CHARACTERISTICS (T_A = 25°C, R_F = 45 MHz, L_O = 55 MHz, P_{LO} = -10 dBm, unless otherwise specified)

PART NUMBER PACKAGE OUTLINE			UPC2798GR S20		
SYMBOLS	PARAMETERS AND CONDITIONS	UNITS	MIN	TYP	MAX
Total Block (V _{CC1} = 5 V, V _{CC2} = 5 V, R _L = 1 kΩ)					
I _{CC}	Circuit Current (no input signal)	mA	24.0	35.5	45.0
CG _{MAX1}	Maximum Conversion Gain, V _{AGC} = 4.0 V, pins G1A - G1B shorted	dB	68.0	74.0	76.0
CG _{MAX2}	Maximum Conversion Gain, V _{AGC} = 4.0 V, pins G1A - G1B open	dB		58.0	
CG _{MIN1}	Minimum Conversion Gain, V _{AGC} = 1.0 V, pins G1A - G1B shorted	dB	32.0	39.0	43.0
CG _{MIN2}	Minimum Conversion Gain, V _{AGC} = 1.0 V, pins G1A - G1B open	dB		22.0	
IIP ₃	Input Intercept Point, V _{AGC} = 1.0 V, pins G1A - G1B shorted	dBm		-14.0	
IIP ₃	Input Intercept Point, V _{AGC} = 1.0 V, pins G1A - G1B open	dBm		-8.0	
Total Block (V _{CC1} = 5 V, V _{CC2} = 9 V, R _L = 1 kΩ)					
I _{CC}	Circuit Current (no input signal)	mA	32.0	47.0	60.0
CG _{MAX1}	Maximum Conversion Gain, V _{AGC} = 4.0 V, pins G1A - G1B shorted	dB	72.0	78.5	81.0
CG _{MAX2}	Maximum Conversion Gain, V _{AGC} = 4.0 V, pins G1A - G1B open	dB		59.0	
CG _{MIN1}	Minimum Conversion Gain, V _{AGC} = 1.0 V, pins G1A - G1B shorted	dB		43.5	
CG _{MIN2}	Minimum Conversion Gain, V _{AGC} = 1.0 V, pins G1A - G1B open	dB		22.5	
IIP ₃	Input Intercept Point, V _{AGC} = 1.0 V, pins G1A - G1B open	dBm		-7.5	
AGC Amplifier and Mixer Block (V _{CC1} = 5 V)					
I _{CC}	Circuit Current (no input signal)	mA	15.0	23.0	28.0
f _{RF}	RF Input Frequency Range	MHz	30		250
f _{OSC}	OSC Frequency Range	MHz	30		250
f _{IF}	IF Output Frequency Range	MHz	DC		150
CG _{MAX}	Maximum Conversion Gain, V _{AGC} = 4.0 V	dB		25	
CG _{MIN}	Minimum Conversion Gain, V _{AGC} = 1.0 V	dB		-7	
GCR	AGC Dynamic Range, V _{AGC} = 1.0 to 4.0 V	dB	26	32	
NF	Noise Figure, SSB, V _{AGC} = 4.0 V (MAX Gain)	dB		9	
V _{AGC (H)}	AGC Voltage High, at MAX Gain	V	4.0		
V _{AGC (L)}	AGC Voltage Low, at MIN Gain	V			1.0
AGC IIP ₃	AGC Input Intercept Point, at MIN Gain	dBm		-9	

ELECTRICAL CHARACTERISTICS ($T_A = 25^\circ\text{C}$, $R_F = 45\text{ MHz}$, $L_O = 55\text{ MHz}$, $P_{LO} = -10\text{ dBm}$, unless otherwise specified)

PART NUMBER PACKAGE OUTLINE			UPC2798GR S20		
SYMBOLS	PARAMETERS AND CONDITIONS	UNITS	MIN	TYP	MAX
Video Amp Block ($V_{CC2} = 5\text{ V}$, differential, $R_L = 1\text{ k}\Omega$)					
I _{CC}	Circuit Current (no input signal)	mA	9.0	12.5	17.0
V _{OUT}	Output Voltage	V _{p-p}		3.0	
G ₁	Differential Gain 1, pins G1A and G1B shorted, $V_{OUT} = 3.0\text{ Vp-p}$	V/V		200	
G ₂	Differential Gain 2, pins G1A and G1B open, $V_{OUT} = 3.0\text{ Vp-p}$	V/V		26	
Video Amp Block ($V_{CC2} = 9\text{ V}$, differential, $R_L = 1\text{ k}\Omega$)					
I _{CC}	Circuit Current (no input signal)	mA	17.0	24.0	32.0
V _{OUT}	Output Voltage	V _{p-p}		3.0	
G ₁	Differential Gain 1, Pins G1A and G1B shorted	V/V		385	
G ₂	Differential Gain 2, Pins G1A and G1B open	V/V		28.5	
Video Amp Block ($V_{CC2} = 5\text{ V}$, single ended, $R_L = 50\ \Omega$)					
A _{VS1}	Single-ended Gain, pins G1A - G1B shorted	dB		40.0	
A _{VS2}	Single-ended Gain, pins G1A - G1B open	dB		22.5	
IIP ₃	Input Intercept Point, pins G1A - G1B open, $f_1 = 9\text{ MHz}$, $f_2 = 11\text{ MHz}$	dBm		-11.5	
Video Amp Block ($V_{CC2} = 9\text{ V}$, single ended, $R_L = 50\ \Omega$)					
A _{VS1}	Single-ended Gain, pins G1A - G1B shorted	dB		45.0	
A _{VS2}	Single-ended Gain, pins G1A - G1B open	dB		23.5	
IIP ₃	Input Intercept Point, pins G1A - G1B open, $f_1 = 9\text{ MHz}$, $f_2 = 11\text{ MHz}$	dBm		-5.0	
Video Amp Block ($V_{CC2} = 5\text{ or }9\text{ V}$, common, $R_L = 1\text{ k}\Omega$)					
BW _{G1}	Bandwidth 1, G1	MHz		50	
BW _{G2}	Bandwidth 2, G2	MHz		50	
R _{IN 1}	Input Resistance 1, G1	k Ω		3.5	
R _{IN 2}	Input Resistance 2, G2	k Ω		9.7	
C _{IN}	Input Capacitance, C _{IN}	pF		1.6	
CMRR	Common Mode Rejection Ratio, $V_{CM} = 1.0\text{ Vp-p}$, $f = 100\text{ kHz}$	dB		80	
PSRR	Power Supply Rejection Ratio	dB		70	
τ_R	Rise Time	ns		2.6	
τ_D	Propagation Delay Time	ns		4.4	

ABSOLUTE MAXIMUM RATINGS¹ ($T_A = 25^\circ\text{C}$)

SYMBOLS	PARAMETERS	UNITS	RATINGS
V _{CC1}	Supply Voltage 1 (Mixer Block)	V	6.0
V _{CC2}	Supply Voltage 2 (Video Amp Block)	V	6.0
P _D	Power Dissipation, $T_A = 85^\circ\text{C}^2$	mW	430
T _{OP}	Operating Temperature	$^\circ\text{C}$	-40 to +85
T _{STG}	Storage Temperature	$^\circ\text{C}$	-55 to +150

SYMBOLS	PARAMETERS	UNITS	RATINGS
V _{CC1}	Supply Voltage 1 (Mixer Block)	V	6.0
V _{CC2}	Supply Voltage 2 (Video Amp Block)	V	11.0
P _D	Power Dissipation, $T_A = 75^\circ\text{C}^2$	mW	500
T _{OP}	Operating Temperature	$^\circ\text{C}$	-40 to +75
T _{STG}	Storage Temperature	$^\circ\text{C}$	-55 to +150

Notes:

- Operation in excess of any one of these parameters may result in permanent damage.
- Mounted on a 50 x 50 x 1.6 mm epoxy glass PWB.

RECOMMENDED OPERATING CONDITIONS

SYMBOL	PARAMETER	UNITS	MIN	TYP	MAX
V _{CC1}	Supply Voltage 1	V	4.5	5.0	5.5
V _{CC2}	Supply Voltage 2	V	4.5	5.0	10.0
T _{A1}	Operating Temp. Range 1*	$^\circ\text{C}$	-40	+25	+85
T _{A2}	Operating Temp. Range 2**	$^\circ\text{C}$	-40	+25	+75

Notes:

* @ $V_{CC1} = V_{CC2} = 4.5\text{ to }5.5\text{ V}$ ** @ $V_{CC1} = 4.5\text{ to }5.5\text{ V}$, $V_{CC2} = 4.5\text{ to }10.0\text{ V}$

TYPICAL CHARACTERISTICS (by measurement circuit 1: AGC Amp and Mixer Block)

CIRCUIT CURRENT vs. SUPPLY VOLTAGE

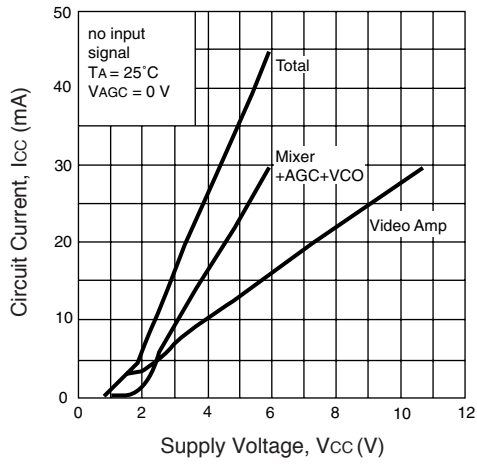

CONVERSION GAIN vs. INPUT FREQUENCY

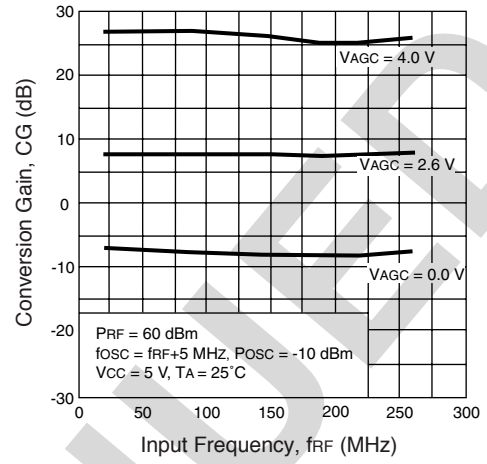

CONVERSION GAIN vs. IF FREQUENCY

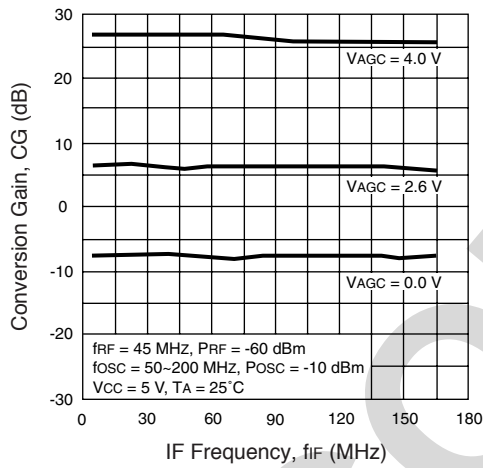

NOISE FIGURE vs. AGC VOLTAGE

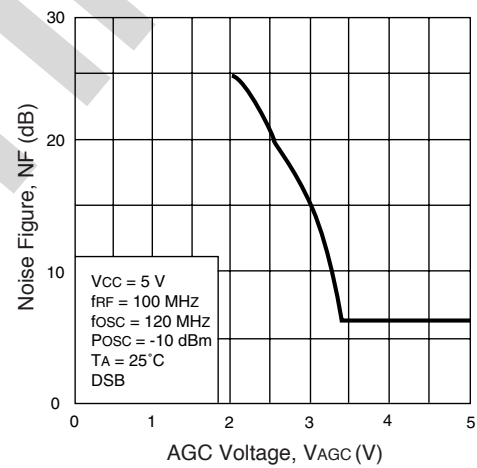

CONVERSION GAIN vs. AGC VOLTAGE

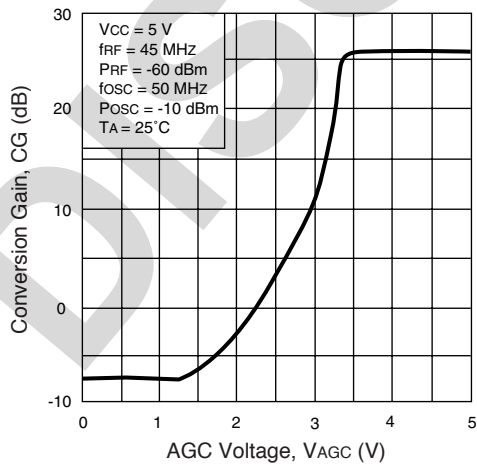

THIRD ORDER INTERMODULATION LEVEL AND OUTPUT POWER vs. INPUT POWER

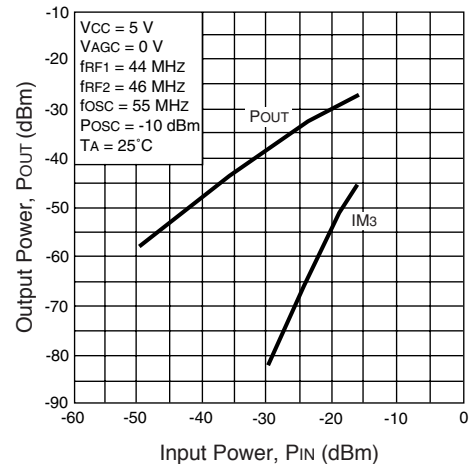

STANDARD CHARACTERISTICS (by measurement circuit 2: Video Amp, $R_L = 1\text{ k}\Omega$, $T_A = 25^\circ\text{C}$)

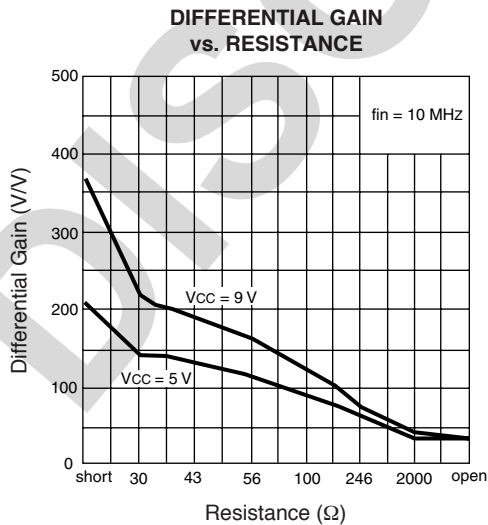
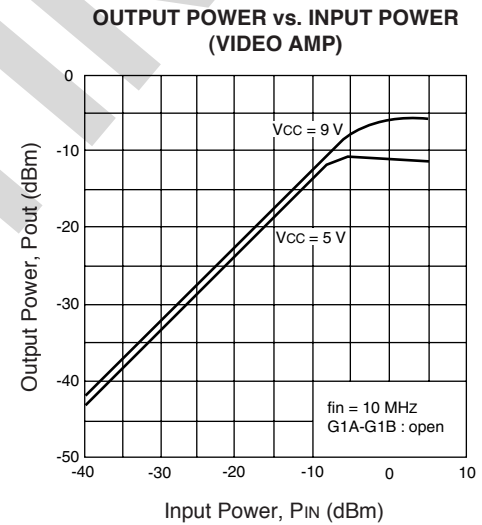
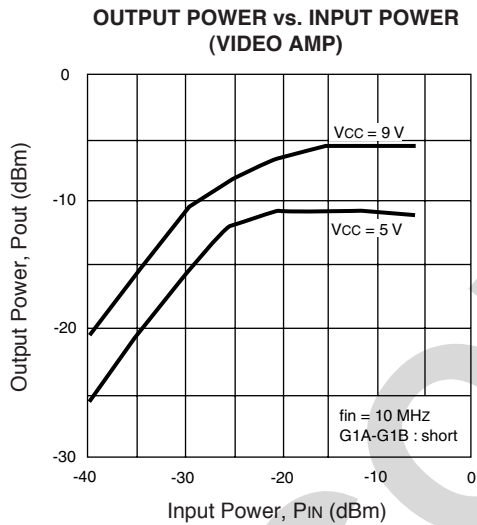
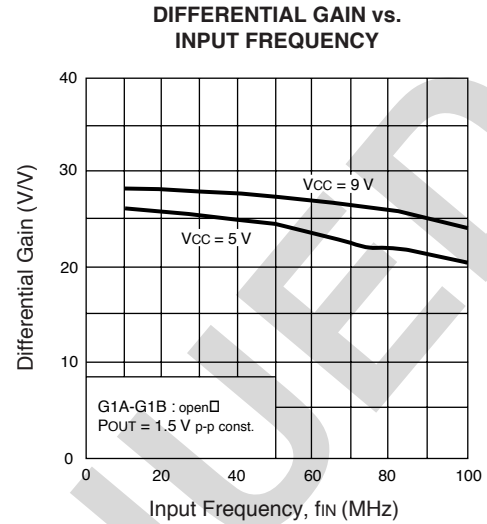
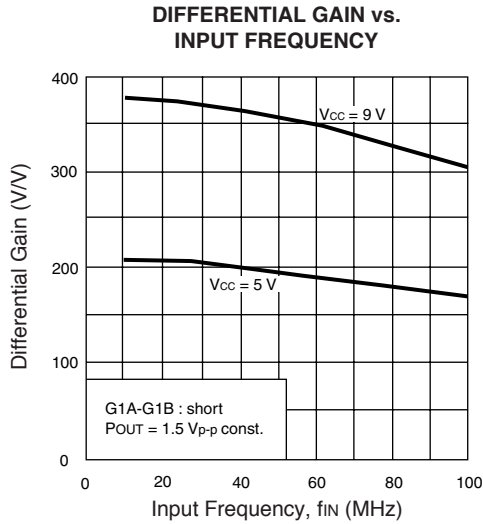

STANDARD CHARACTERISTICS (by measurement circuit 3: Video Amp, $R_L = 50 \Omega$, $T_A = 25^\circ\text{C}$)

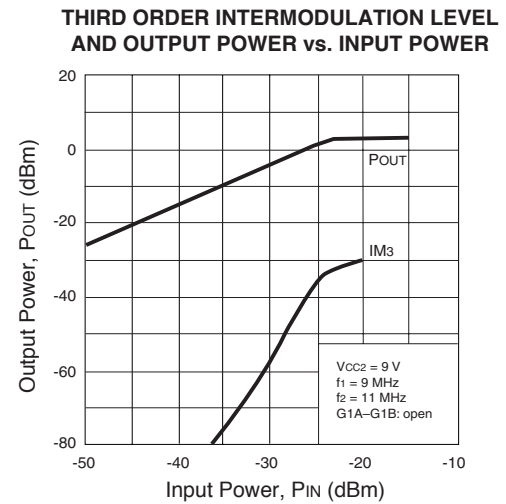
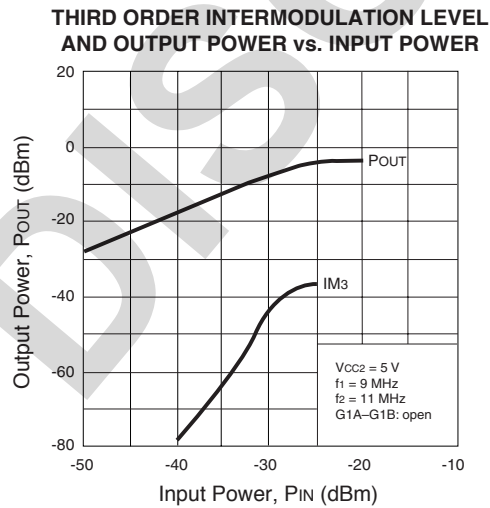
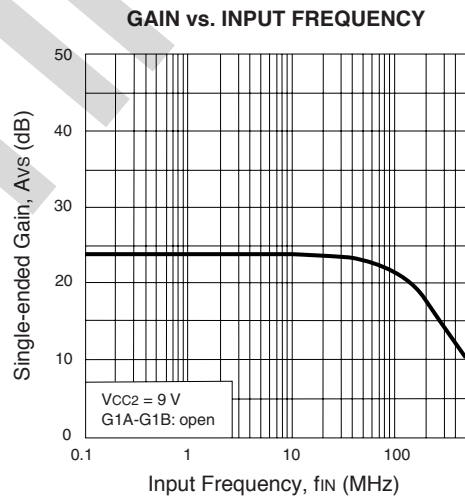
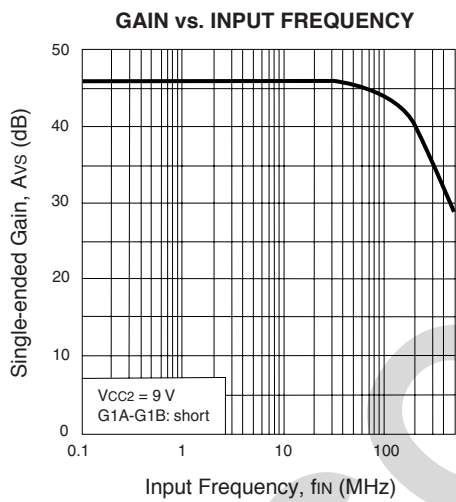
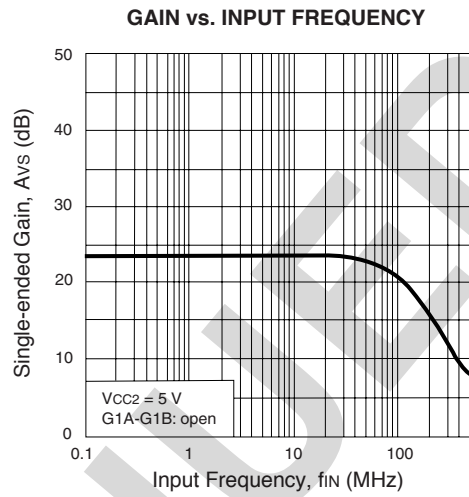
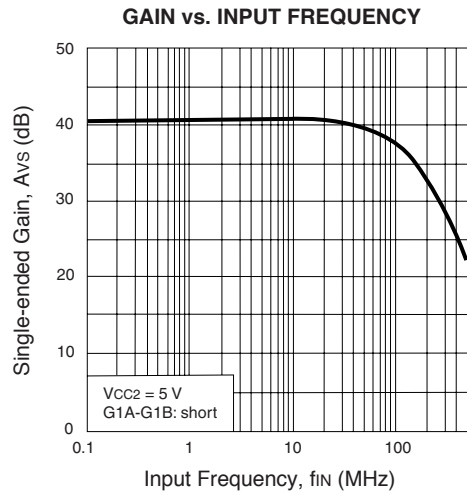

TYPICAL CHARACTERISTICS (by measurement circuit 4: Total Block, $f_{RF} = 45$ MHz, $Prf = -60$ dBm, $Posc = -10$ dBm)

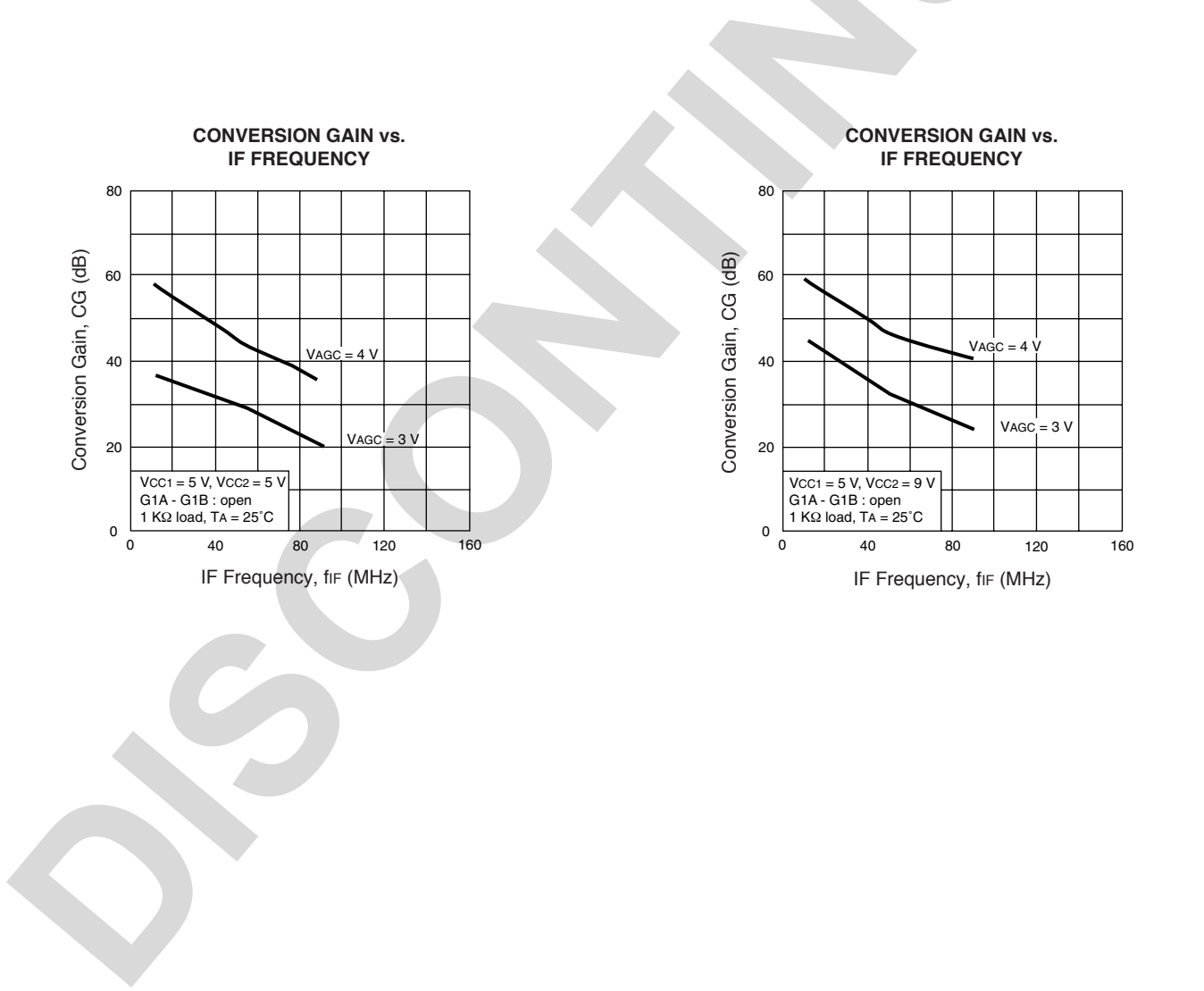
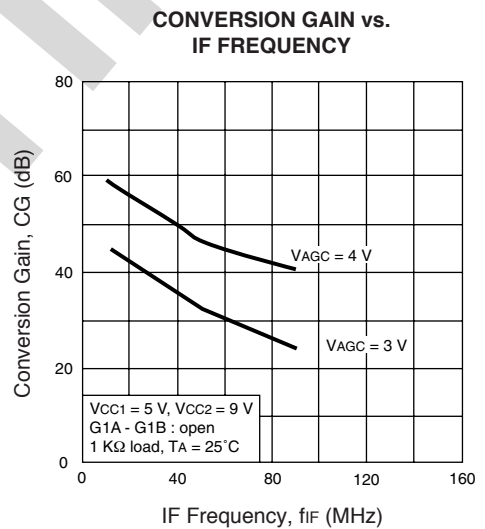
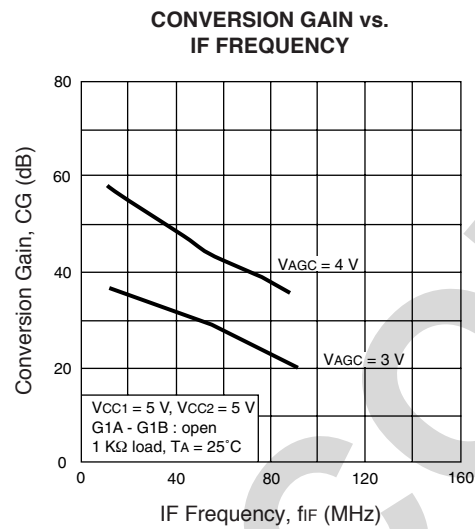
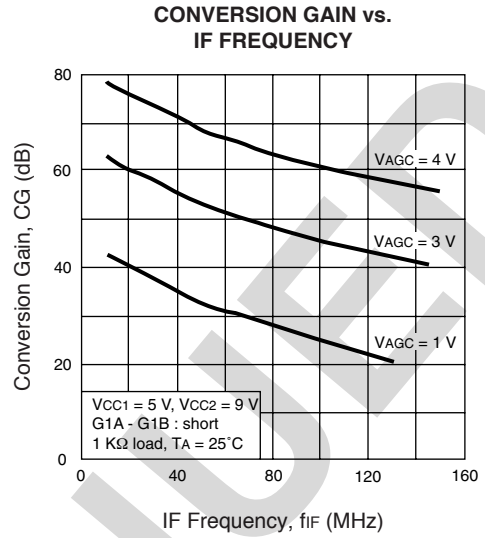
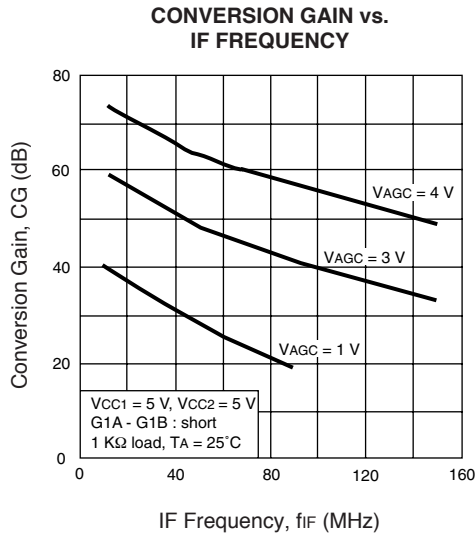

TYPICAL CHARACTERISTICS (by measurement circuit 4: Total Block, $P_{RF} = -60$ dBm, $f_{osc} = f_{RF} + 10$ MHz, $P_{osc} = -10$ dBm)

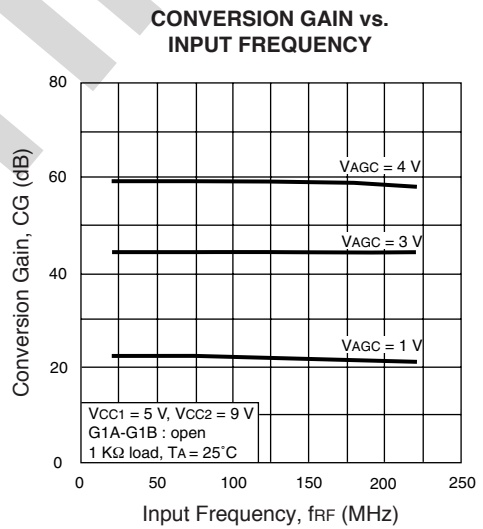
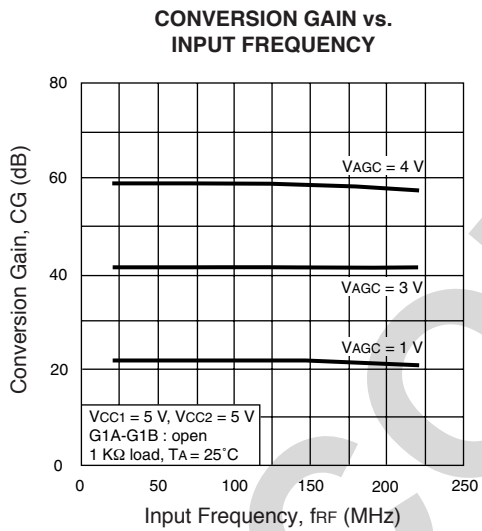
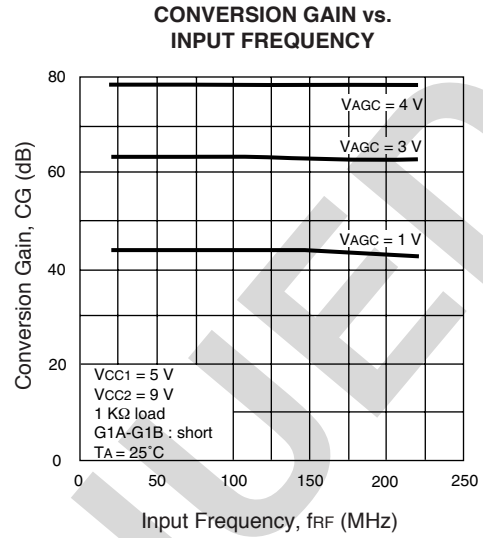
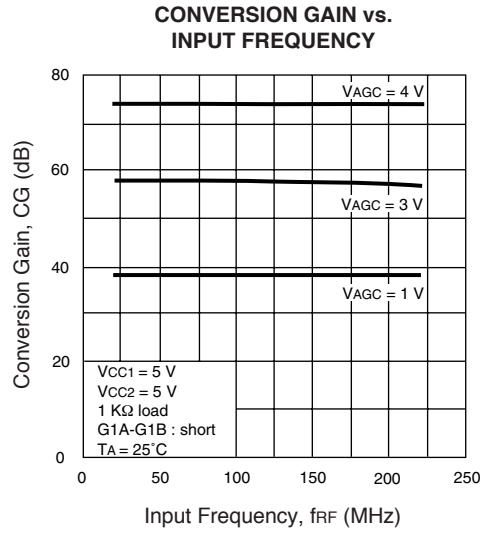

DISCONTINUED

STANDARD CHARACTERISTICS (by measurement circuit 4: Total Block)

THIRD ORDER INTERMODULATION LEVEL AND OUTPUT POWER vs. INPUT POWER

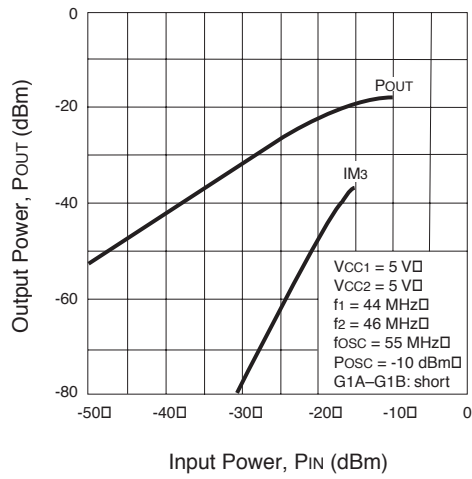

THIRD ORDER INTERMODULATION LEVEL AND OUTPUT POWER vs. INPUT POWER

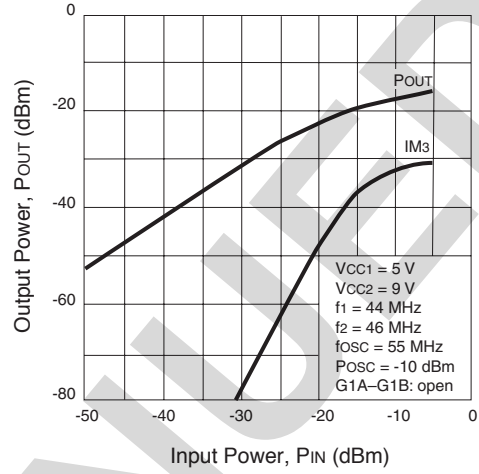

THIRD ORDER INTERMODULATION LEVEL AND OUTPUT POWER vs. INPUT POWER

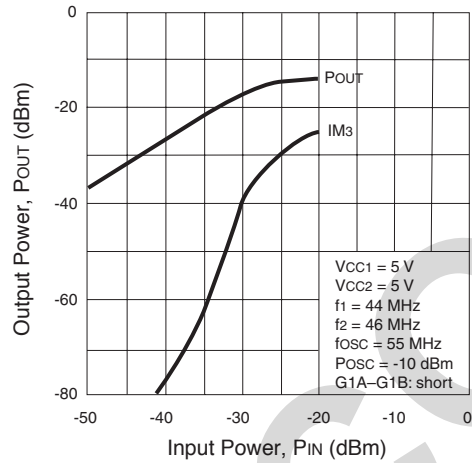

STANDARD CHARACTERISTICS (by application circuit example : MIXER block)

CONVERSION GAIN vs. INPUT FREQUENCY

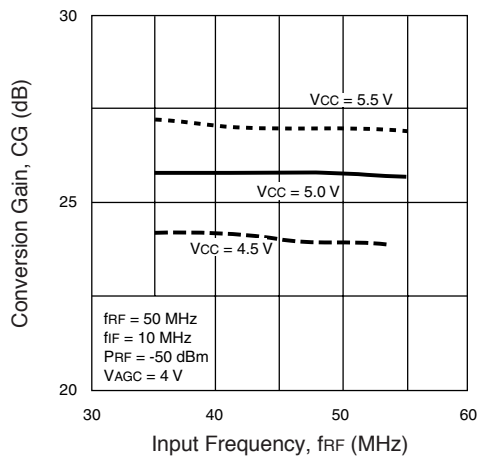

NOISE FIGURE vs. AGC VOLTAGE

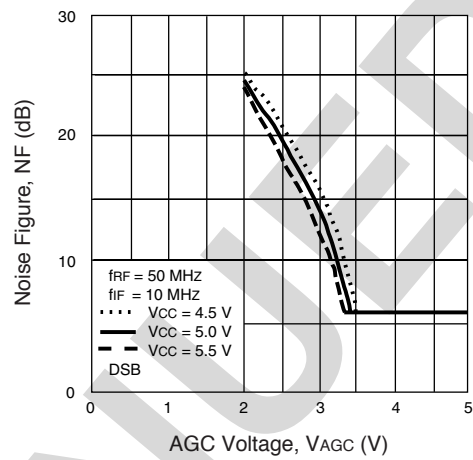

CONVERSION GAIN vs. AGC VOLTAGE

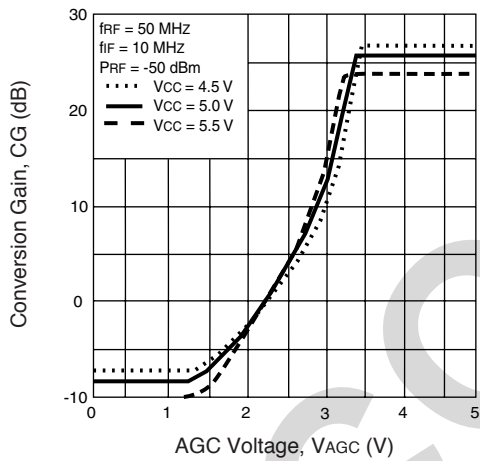

THIRD ORDER INTERMODULATION LEVEL AND OUTPUT POWER vs. INPUT POWER

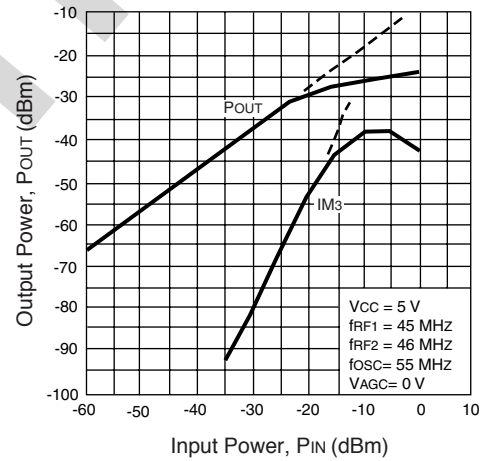

OSCILLATOR FREQUENCY vs. TUNING VOLTAGE

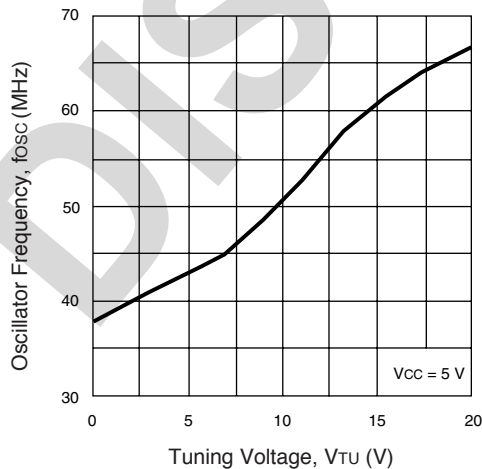

PIN FUNCTIONS

Pin No.	Pin Name	Pin Voltage Typ. (V)	Function and Explanation	Equivalent Circuit
1	AGC IN1	1.5	RF input pins. Pins 1 and 2 are each base inputs to a differential amplifier. In the case of a single-ended input, bypass the unused pin to ground through a capacitor.	
2	AGC IN2	1.5		
3	VAGC	0~5	Gain control pin of the mixer input amplifier. VAGC up = gain up. It is recommended to use a 100k Ω voltage divider at this pin.	
4	Vcc1	5.0	Supply voltage pin for the downconverter block. This pin should be connected with a bypass capacitor (e.g., 1000 pF) to minimize ground impedance.	
5	OSC OUT	4.0	Output pin for the internal oscillator. This pin may be connected to the input of a PLL synthesizer.	
6	GND	0.0	Ground pin. This pin must be connected to system ground. Form ground pattern as wide as possible to minimize ground impedance.	
7	OSC B2	2.4	Input pins for the internal oscillator. The internal oscillator consists of a balanced amplifier.	
8	OSC C1	4.6		
9	OSC C2	4.6		
10	OSC B1	2.4		

PIN FUNCTIONS

Pin No.	Pin Name	Pin Voltage Typ. (V) () is value at $V_{CC} = 9V$	Function and Explanation	Equivalent Circuit
11	OUT2	2.5 (4.7)	Output pins for the video amplifier. With $R_L = 1k\ \Omega$, the differential output voltage is 3 Vp-p. OUT1 and INA are in phase. OUT2 and INB are in phase. In the case of a single-ended output, bypass the unused pin to ground through a capacitor.	
12	OUT1	2.5 (4.7)		
13	Vcc2	5~9	Supply voltage pin for the video amplifier block. This pin should be connected with a bypass capacitor (e.g., 1000 pF) to minimize ground impedance.	
14	INB	2.5 (4.1)	Input pins for the video amplifier. These pins have high impedance. In the case of a single-ended input, bypass the unused pin to ground through a capacitor.	
15	INA	2.5 (4.1)		
16	G1B	1.7 (3.3)	Gain control pins for the video amplifier. The gain may be adjusted by varying the value of the resistor between pins 16 and 17. Maximum gain = short; Minimum gain = open.	
17	G1A	1.7 (3.3)		
18	MIX OUT1	3.7	Output pins for the downconverter. These are emitter follower outputs which feature low impedance. In the case of a single-ended output, bypass the unused pin to ground through a capacitor.	
19	MIX OUT2	3.7		
20	GND	0.0	Ground pin. This pin must be connected to system ground. Form ground pattern as wide as possible to minimize ground impedance.	

MEASUREMENT CIRCUIT 1

AGC & MIXER BLOCK

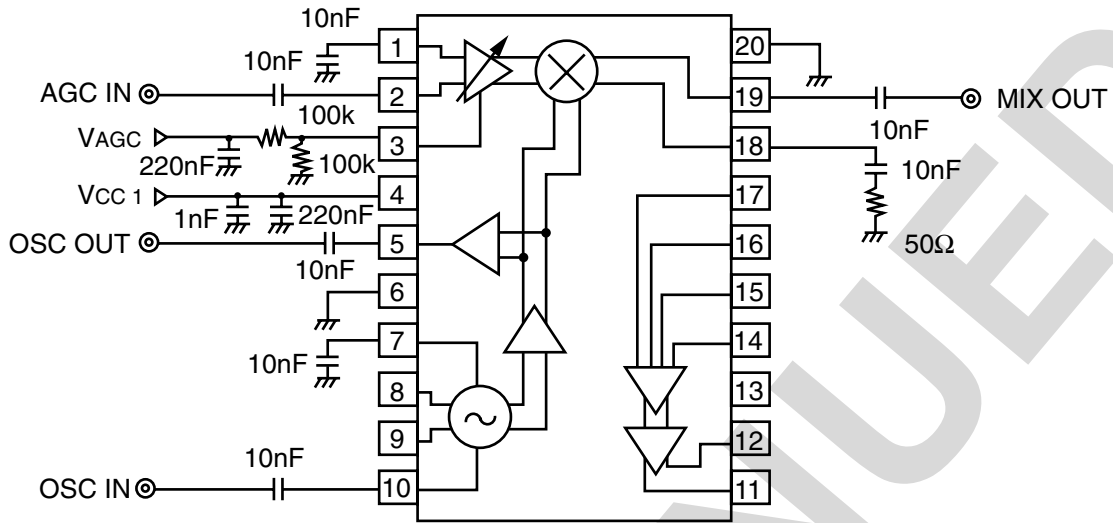

MEASUREMENT CIRCUIT 2

VIDEO AMP BLOCK
RL = 1kΩ

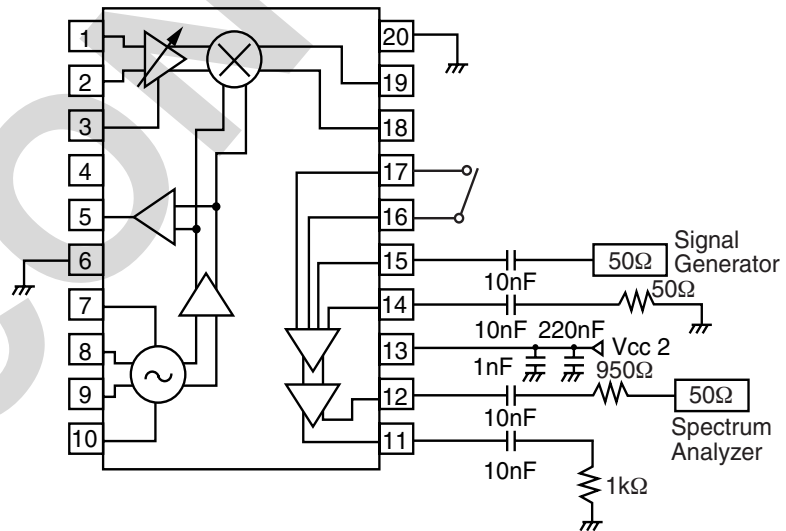

MEASUREMENT CIRCUIT 3

VIDEO AMP BLOCK
 $R_L = 50\Omega$

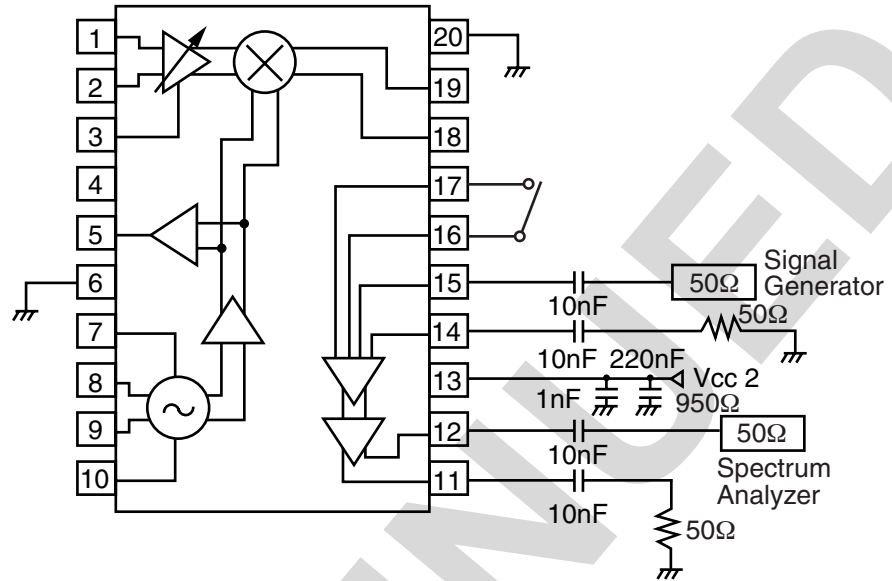

MEASUREMENT CIRCUIT 4

TOTAL BLOCK

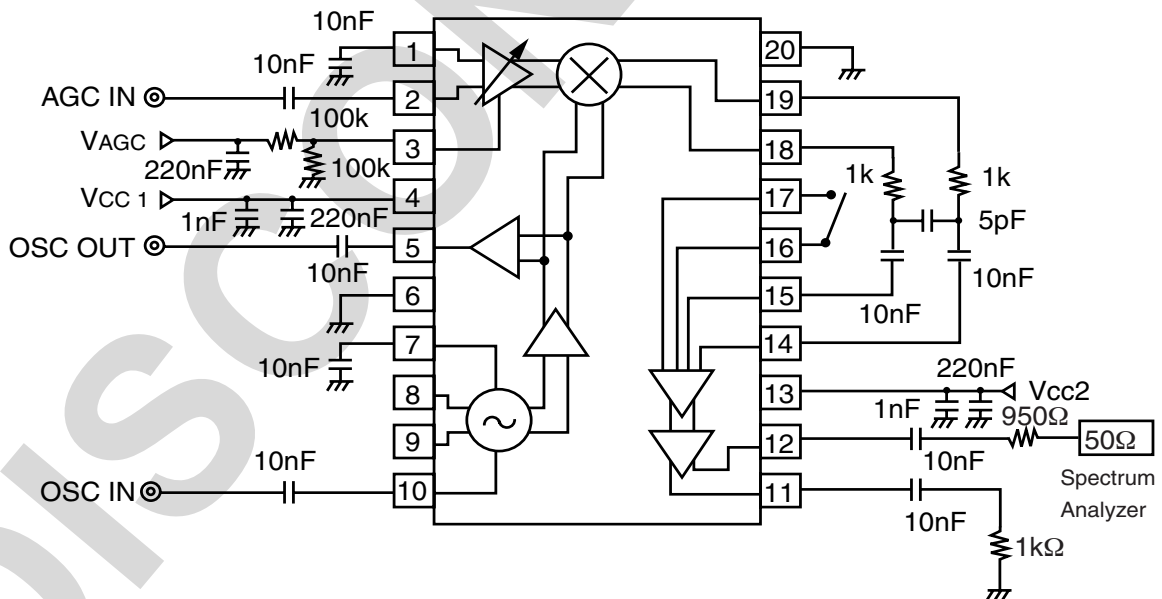

APPLICATION CIRCUIT EXAMPLE

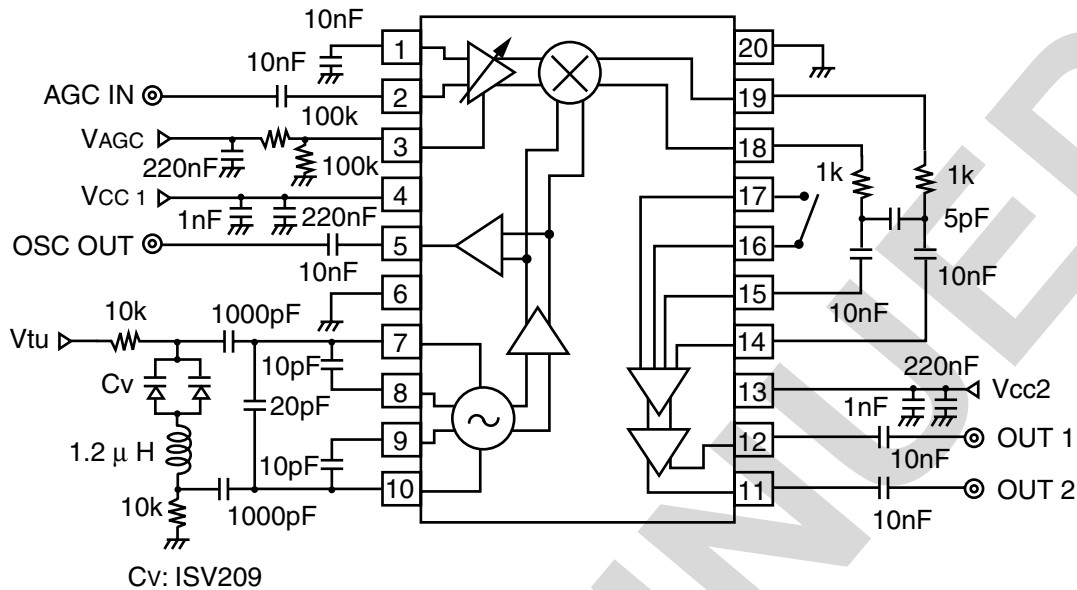

OUTLINE DIMENSIONS (Units in mm)

INTERNAL BLOCK DIAGRAM

PACKAGE OUTLINE SSOP 20

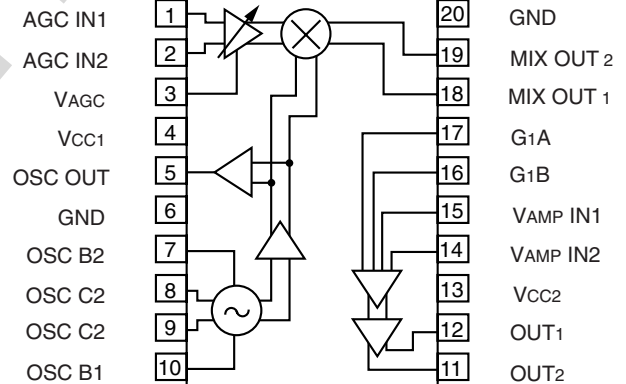
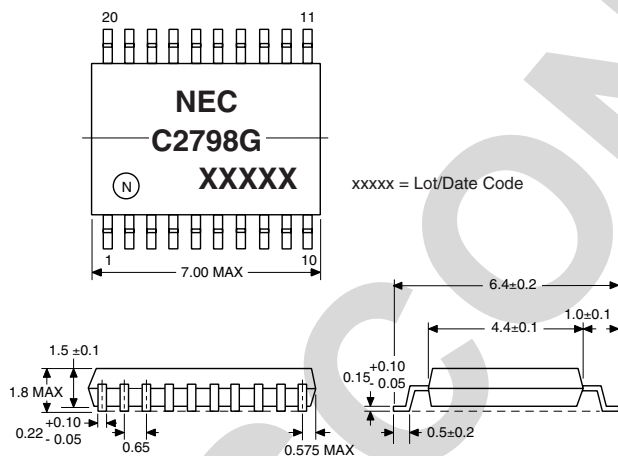

All dimensions are typical unless specified otherwise.

ORDERING INFORMATION

PART NUMBER	QUANTITY
UPC2798GR-E1-A	2500/Reel

Notes: Embossed tape, 12 mm wide.

Life Support Applications

These NEC products are not intended for use in life support devices, appliances, or systems where the malfunction of these products can reasonably be expected to result in personal injury. The customers of CEL using or selling these products for use in such applications do so at their own risk and agree to fully indemnify CEL for all damages resulting from such improper use or sale.

EXCLUSIVE NORTH AMERICAN AGENT FOR **NEC** RF, MICROWAVE & OPTOELECTRONIC SEMICONDUCTORS

CEL CALIFORNIA EASTERN LABORATORIES • Headquarters • 4590 Patrick Henry Drive • Santa Clara, CA 95054-1817 • (408) 988-3500 • Telex 34-6393 • FAX (408) 988-0279
24-Hour Fax-On-Demand: 800-390-3232 (U.S. and Canada only) • Internet: <http://WWW.CEL.COM>

DATA SUBJECT TO CHANGE WITHOUT NOTICE

Subject: Compliance with EU Directives

CEL certifies, to its knowledge, that semiconductor and laser products detailed below are compliant with the requirements of European Union (EU) Directive 2002/95/EC Restriction on Use of Hazardous Substances in electrical and electronic equipment (RoHS) and the requirements of EU Directive 2003/11/EC Restriction on Penta and Octa BDE.

CEL Pb-free products have the same base part number with a suffix added. The suffix –A indicates that the device is Pb-free. The –AZ suffix is used to designate devices containing Pb which are exempted from the requirement of RoHS directive (*). In all cases the devices have Pb-free terminals. All devices with these suffixes meet the requirements of the RoHS directive.

This status is based on CEL’s understanding of the EU Directives and knowledge of the materials that go into its products as of the date of disclosure of this information.

Restricted Substance per RoHS	Concentration Limit per RoHS (values are not yet fixed)	Concentration contained in CEL devices	
		-A	-AZ
Lead (Pb)	< 1000 PPM	Not Detected	(*)
Mercury	< 1000 PPM	Not Detected	
Cadmium	< 100 PPM	Not Detected	
Hexavalent Chromium	< 1000 PPM	Not Detected	
PBB	< 1000 PPM	Not Detected	
PBDE	< 1000 PPM	Not Detected	

If you should have any additional questions regarding our devices and compliance to environmental standards, please do not hesitate to contact your local representative.

Important Information and Disclaimer: Information provided by CEL on its website or in other communications concerning the substance content of its products represents knowledge and belief as of the date that it is provided. CEL bases its knowledge and belief on information provided by third parties and makes no representation or warranty as to the accuracy of such information. Efforts are underway to better integrate information from third parties. CEL has taken and continues to take reasonable steps to provide representative and accurate information but may not have conducted destructive testing or chemical analysis on incoming materials and chemicals. CEL and CEL suppliers consider certain information to be proprietary, and thus CAS numbers and other limited information may not be available for release.

In no event shall CEL’s liability arising out of such information exceed the total purchase price of the CEL part(s) at issue sold by CEL to customer on an annual basis.

See CEL Terms and Conditions for additional clarification of warranties and liability.

Looking for pricing, stock, or lifecycle information?

Click below to explore more details on WIN SOURCE:

 [View UPC2798GR-E1-A on WIN SOURCE](#)

 [CEL Information](#)

Optimize Your Supply Chain with WIN SOURCE Solutions

-  Global Sourcing Solution
-  Obsolete Management
-  Cost Control Management
-  Shortage Management
-  Alternative Solution
-  Excess Inventory Management