



3-Pin Microprocessor Supervisor Circuit with Open-Drain Reset Output

General Description

The MIC803 is a single-voltage supervisor with open-drain reset output that provides accurate power supply monitoring and reset generation in microprocessor-based systems. The function of the device is to assert a reset signal if the power supply voltage drops below the reset threshold voltage, and retain this reset for the reset timeout period once the power supply increases above the reset threshold voltage.

The MIC803 consumes only 4.5µA of supply current and offers three reset delay periods of 20ms, 140ms, and 1120ms (minimum). It features factory-programmed reset threshold levels from 2.63V to 4.63V to accommodate 3.0V, 3.3V, and 5.0V power supplies. It is available in the compact 3-pin SC-70 and SOT-23 packages.

Datasheets and support documentation are available on Micrel's web site at: www.micrel.com.

Features

- 4.5µA supply current (typical) at 3.6V
- Open-drain /RESET output
- /RESET remains valid with V_{CC} as low as 1V
- 20ms, 140ms, or 1120ms (minimum) reset timeout options
- 2.63V to 4.63V preset voltage threshold options
- 2.5% voltage threshold accuracy over temperature
- 3-pin SC70-3 package (2.0mm × 2.1mm)
- 3-pin SOT-23 package (2.3mm × 2.9mm)
- -40°C to +125°C junction temperature range

Applications

- Critical microcomputer power monitoring
- Portable equipment
- Solid state drives
- Printers/computers
- Embedded controllers

Typical Application

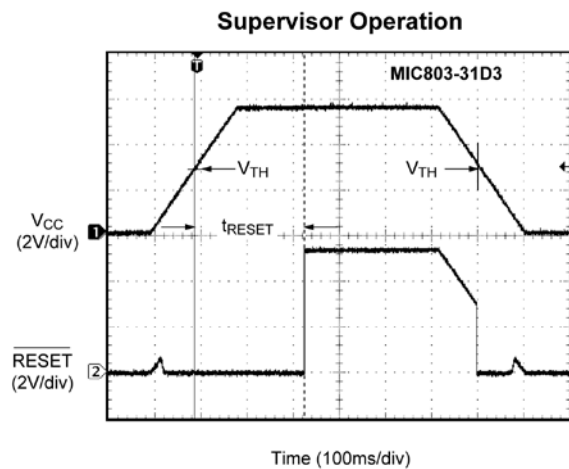
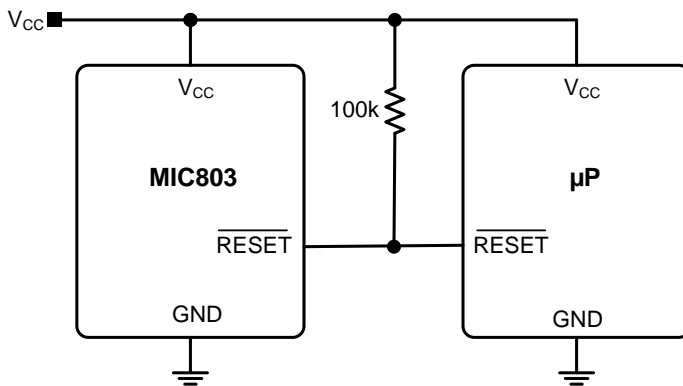

Ordering Information⁽¹⁾

Part Number	Marking ⁽²⁾	Nominal V _{TH} (V)	Minimum t _{RESET} ⁽³⁾ (ms)	Junction Temperature Range	Package
MIC803-46D2VC3	<u>AS</u>	4.63	20	-40° to +125°C	SC70-3
MIC803-44D2VC3	<u>AP</u>	4.38	20	-40° to +125°C	SC70-3
MIC803-41D2VC3	<u>AK</u>	4.10	20	-40° to +125°C	SC70-3
MIC803-40D2VC3	<u>A2</u>	4.00	20	-40° to +125°C	SC70-3
MIC803-31D2VC3	<u>AG</u>	3.08	20	-40° to +125°C	SC70-3
MIC803-30D2VC3	<u>AV</u>	3.00	20	-40° to +125°C	SC70-3
MIC803-29D2VC3	<u>AD</u>	2.93	20	-40° to +125°C	SC70-3
MIC803-26D2VC3	<u>AA</u>	2.63	20	-40° to +125°C	SC70-3
MIC803-46D3VC3	<u>AT</u>	4.63	140	-40° to +125°C	SC70-3
MIC803-44D3VC3	<u>AQ</u>	4.38	140	-40° to +125°C	SC70-3
MIC803-41D3VC3	<u>AM</u>	4.10	140	-40° to +125°C	SC70-3
MIC803-40D3VC3	<u>A5</u>	4.00	140	-40° to +125°C	SC70-3
MIC803-31D3VC3	<u>A4</u>	3.08	140	-40° to +125°C	SC70-3
MIC803-30D3VC3	<u>AX</u>	3.00	140	-40° to +125°C	SC70-3
MIC803-29D3VC3	<u>AE</u>	2.93	140	-40° to +125°C	SC70-3
MIC803-26D3VC3	<u>AB</u>	2.63	140	-40° to +125°C	SC70-3
MIC803-46D4VC3	<u>AU</u>	4.63	1120	-40° to +125°C	SC70-3
MIC803-44D4VC3	<u>AR</u>	4.38	1120	-40° to +125°C	SC70-3
MIC803-41D4VC3	<u>AN</u>	4.10	1120	-40° to +125°C	SC70-3
MIC803-40D4VC3	<u>A6</u>	4.00	1120	-40° to +125°C	SC70-3
MIC803-31D4VC3	<u>AJ</u>	3.08	1120	-40° to +125°C	SC70-3
MIC803-30D4VC3	<u>AZ</u>	3.00	1120	-40° to +125°C	SC70-3
MIC803-29D4VC3	<u>A3</u>	2.93	1120	-40° to +125°C	SC70-3
MIC803-26D4VC3	<u>AC</u>	2.63	1120	-40° to +125°C	SC70-3
MIC803-46D2VM3	<u>AS</u>	4.63	20	-40° to +125°C	SOT23-3
MIC803-44D2VM3	<u>AP</u>	4.38	20	-40° to +125°C	SOT23-3
MIC803-41D2VM3	<u>AK</u>	4.10	20	-40° to +125°C	SOT23-3
MIC803-40D2VM3	<u>A2</u>	4.00	20	-40° to +125°C	SOT23-3
MIC803-31D2VM3	<u>AG</u>	3.08	20	-40° to +125°C	SOT23-3
MIC803-30D2VM3	<u>AV</u>	3.00	20	-40° to +125°C	SOT23-3
MIC803-29D2VM3	<u>AD</u>	2.93	20	-40° to +125°C	SOT23-3
MIC803-26D2VM3	<u>AA</u>	2.63	20	-40° to +125°C	SOT23-3
MIC803-46D3VM3	<u>AT</u>	4.63	140	-40° to +125°C	SOT23-3

Note:

- All devices available in tape and reel only. (Order entry PN, add TR. Example: MIC803-26D4VM3 TR)
Standard/full reel quantity is 3,000 pieces.
Reel diameter is 7 inches. Hub diameter is 2 inches. Width is 8mm.
- Underbar symbol () may not be to scale.
- 40° to +85°C temperature range.

Ordering Information⁽¹⁾ (Continued)

Part Number	Marking ⁽²⁾	Nominal V_{TH} (V)	Minimum $t_{RESET}^{(3)}$ (ms)	Junction Temperature Range	Package
MIC803-44D3VM3	<u>AQ</u>	4.38	140	-40° to +125°C	SOT23-3
MIC803-41D3VM3	<u>AM</u>	4.10	140	-40° to +125°C	SOT23-3
MIC803-40D3VM3	<u>A5</u>	4.00	140	-40° to +125°C	SOT23-3
MIC803-31D3VM3	<u>A4</u>	3.08	140	-40° to +125°C	SOT23-3
MIC803-30D3VM3	<u>AX</u>	3.00	140	-40° to +125°C	SOT23-3
MIC803-29D3VM3	<u>AE</u>	2.93	140	-40° to +125°C	SOT23-3
MIC803-26D3VM3	<u>AB</u>	2.63	140	-40° to +125°C	SOT23-3
MIC803-46D4VM3	<u>AU</u>	4.63	1120	-40° to +125°C	SOT23-3
MIC803-44D4VM3	<u>AR</u>	4.38	1120	-40° to +125°C	SOT23-3
MIC803-41D4VM3	<u>AN</u>	4.10	1120	-40° to +125°C	SOT23-3
MIC803-40D4VM3	<u>A6</u>	4.00	1120	-40° to +125°C	SOT23-3
MIC803-31D4VM3	<u>AJ</u>	3.08	1120	-40° to +125°C	SOT23-3
MIC803-30D4VM3	<u>AZ</u>	3.00	1120	-40° to +125°C	SOT23-3
MIC803-29D4VM3	<u>A3</u>	2.93	1120	-40° to +125°C	SOT23-3
MIC803-26D4VM3	<u>AC</u>	2.63	1120	-40° to +125°C	SOT23-3

Part Numbering Convention



Pin Configuration

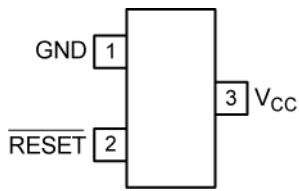

**3-Pin SC70
(Top View)**

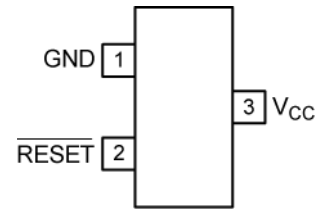

**3-Pin SOT-23
(Top View)**

Pin Description

Pin Number	Pin Name	Pin Function
1	GND	Ground Pin.
2	/RESET	/RESET goes low if V_{CC} falls below the reset threshold (V_{TH}), and remains asserted for one timeout period after V_{CC} exceeds V_{TH} .
3	V_{CC}	Power Supply Input and Monitored Voltage.

Absolute Maximum Ratings⁽⁴⁾

Supply Voltage (V_{CC})	-0.3V to 6.0V
Reset Output (/RESET)	-0.3V to 6.0V
Input Current (V_{CC})	20mA
Output Current (/RESET)	20mA
Rate of Rise (V_{CC})	100V/ μ s
Junction Temperature (T_J)	+150°C
Lead Temperature (soldering, 10s)	260°C
Storage Temperature (T_S)	-65°C to +150°C
ESD Rating ⁽⁶⁾	3kV

Operating Ratings⁽⁵⁾

Supply Voltage (V_{CC})	1.0V to 5.5V
Reset Output Voltage (/RESET)	0.0V to 5.5V
Junction Temperature (T_J)	-40°C to +125°C
Junction Thermal Resistance	
3-Pin SC70 (θ_{JA})	260°C/W
3-Pin SOT-23 (θ_{JA})	203°C/W

Electrical Characteristics⁽⁷⁾

For typical values, $V_{CC} = 5.0V$ for MIC803-46/44/41/40, $V_{CC} = 3.3V$ for MIC803-31/30/29, $V_{CC} = 3.0V$ for MIC803-26; $T_J = 25^\circ C$, **Bold** values indicate $-40^\circ C \leq T_J \leq +125^\circ C$; unless noted.

Parameter	Conditions	Min.	Typ.	Max.	Units	
Power Supply Input						
Operating Voltage Range (V_{CC})	$T_J = -40^\circ C$ to $+85^\circ C$	1.0		5.5	V	
	$T_J = -40^\circ C$ to $+125^\circ C$	1.2		5.5		
Supply Current (I_{CC})	$T_J = -40^\circ C$ to $+85^\circ C$	$V_{CC} = 5.5V$, No Load		5.5	μA	
		$V_{CC} = 3.6V$, No Load		4.5		
	$T_J = +85^\circ C$ to $+125^\circ C$	$V_{CC} = 5.5V$, No Load				18
		$V_{CC} = 3.6V$, No Load				13
Voltage Threshold						
Reset Threshold (V_{TH})	MIC803-46	$T_J = -40^\circ C$ to $+85^\circ C$	4.50	4.63	4.75	V
		$T_J = -40^\circ C$ to $+125^\circ C$	4.44		4.82	
	MIC803-44	$T_J = -40^\circ C$ to $+85^\circ C$	4.25	4.38	4.50	
		$T_J = -40^\circ C$ to $+125^\circ C$	4.20		4.56	
	MIC803-41	$T_J = -40^\circ C$ to $+85^\circ C$	4.00	4.10	4.20	
		$T_J = -40^\circ C$ to $+125^\circ C$	3.97		4.24	
	MIC803-40	$T_J = -40^\circ C$ to $+85^\circ C$	3.89	4.00	4.10	
		$T_J = -40^\circ C$ to $+125^\circ C$	3.80		4.20	
	MIC803-31	$T_J = -40^\circ C$ to $+85^\circ C$	3.00	3.08	3.15	
		$T_J = -40^\circ C$ to $+125^\circ C$	2.95		3.21	

Notes:

- Exceeding the absolute maximum ratings may damage the device.
- The device is not guaranteed to function outside its operating ratings.
- Devices are ESD sensitive. Handling precautions are recommended. Human body model, 1.5k Ω in series with 100pF.
- Specification for packaged product only.

Electrical Characteristics⁽⁷⁾ (Continued)

For typical values, $V_{CC} = 5.0V$ for MIC803-46/44/41/40, $V_{CC} = 3.3V$ for MIC803-31/30/29, $V_{CC} = 3.0V$ for MIC803-26; $T_J = 25^\circ C$, **Bold** values indicate $-40^\circ C \leq T_J \leq +125^\circ C$; unless noted.

Parameter	Conditions	Min.	Typ.	Max.	Units	
Voltage Threshold (Continued)						
Reset Threshold (V_{TH})	MIC803-30	$T_J = -40^\circ C$ to $+85^\circ C$	2.93	3.00	3.08	V
		$T_J = -40^\circ C$ to $+125^\circ C$	2.90		3.11	
	MIC803-29	$T_J = -40^\circ C$ to $+85^\circ C$	2.82	2.93	3.00	
		$T_J = -40^\circ C$ to $+125^\circ C$	2.81		3.05	
	MIC803-26	$T_J = -40^\circ C$ to $+85^\circ C$	2.55	2.63	2.70	
		$T_J = -40^\circ C$ to $+125^\circ C$	2.50		2.76	
Reset Time						
V_{CC} to /RESET Delay (t_D)	$V_{CC} = V_{TH}$ to $(V_{TH} - 100mV)$			15		μs
Reset Timeout Period (t_{RESET})	D2	$T_J = -40^\circ C$ to $+85^\circ C$	20	35	44	ms
		$T_J = -40^\circ C$ to $+125^\circ C$	16		48	
	D3	$T_J = -40^\circ C$ to $+85^\circ C$	140	230	360	
		$T_J = -40^\circ C$ to $+125^\circ C$	112		420	
	D4	$T_J = -40^\circ C$ to $+85^\circ C$	1120	1800	2400	
		$T_J = -40^\circ C$ to $+125^\circ C$	900		3200	
Reset Output						
/RESET Output Voltage (V_{OL})	$V_{CC} \geq 4.0V$, $I_{SINK} = 3.2mA$				0.4	V
	$V_{CC} > 2.5V$, $I_{SINK} = 1.2mA$				0.3	V
	$V_{CC} \geq 1.0V$, $I_{SINK} = 50\mu A$				0.3	V
/RESET Output Leakage	$V_{CC} > V_{TH}$, /RESET Deasserted				1	μA

Typical Characteristics



Timing Diagram



Functional Diagram



Application Information

Microprocessor Reset

The $\overline{\text{RESET}}$ pin is asserted whenever V_{CC} falls below the reset threshold voltage, V_{TH} . The $\overline{\text{RESET}}$ pin remains asserted for the duration of the reset timeout period (t_{RESET}) after V_{CC} has risen above the reset threshold voltage. The reset function ensures the microprocessor is properly reset and powers up in a known condition after a power failure. $\overline{\text{RESET}}$ will remain valid with V_{CC} as low as 1.0V.

The $\overline{\text{RESET}}$ output is a simple open-drain N-channel MOSFET structure. A pull-up resistor must be used to pull this output up to some voltage. For most applications, this voltage will be the same power supply that supplies V_{CC} to the MIC803. As shown in Figure 1, it is possible, however, to tie this resistor to some other voltage. This will allow the MIC803 to monitor one voltage while level-shifting the $\overline{\text{RESET}}$ output to some other voltage. The pull-up voltage must be limited to 5.5V. The resistor must be small enough to supply current to the inputs and leakage paths that are driven by the $\overline{\text{RESET}}$ output.

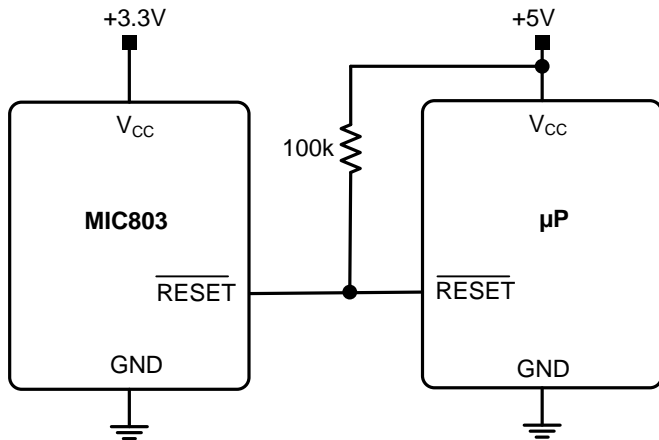

Figure 1. MIC803 Used in a Multiple Supply System

$\overline{\text{RESET}}$ Valid at Low Voltage

As V_{CC} drops to 0V, the MIC803 will no longer be able to pull the $\overline{\text{RESET}}$ output low, and the pull-up resistor will pull the output high. The value of the pull-up resistor and the voltage it is connected to will affect the point at which this happens.

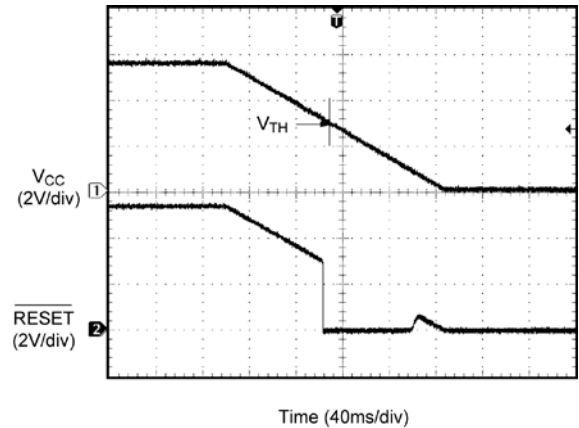

Figure 2. $\overline{\text{RESET}}$ at Falling V_{CC}

Wire ORing the $\overline{\text{RESET}}$ Output

Since the $\overline{\text{RESET}}$ output is open-drain, several reset sources can be wire-ORed, in parallel, to allow resets from multiple sources.

V_{CC} Transients

The MIC803 is relatively immune to negative-going V_{CC} glitches below the reset threshold (see [Typical Characteristics](#), graph titled “Maximum Transient Duration vs. Overdrive”). As shown in Figure 3, the overdrive voltage is the difference between the threshold voltage and the minimum point of the V_{CC} glitch. Typically, an overdrive of 100mV, with duration of 15μs or less will not cause a reset. If additional transient immunity is needed, a 0.1μF bypass capacitor can be placed as close as possible to the MIC803 on the V_{CC} pin.

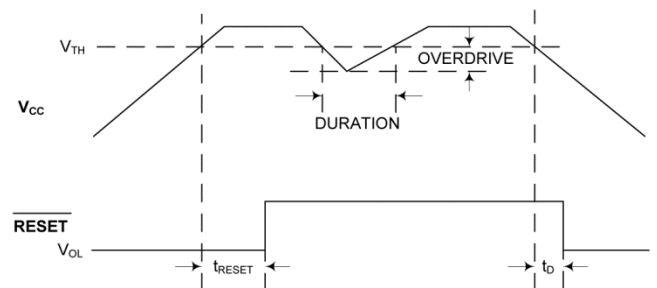

Figure 3. V_{CC} Threshold

Package Information and Recommended Landing Pattern⁽⁸⁾



3-Pin SC70 (MM)

Note:

8. Package information is correct as of the publication date. For updates and most current information, go to www.micrel.com.

Package Information and Recommended Landing Pattern⁽⁸⁾



3-Pin SOT-23 (MM)

MICREL, INC. 2180 FORTUNE DRIVE SAN JOSE, CA 95131 USA
TEL +1 (408) 944-0800 FAX +1 (408) 474-1000 WEB <http://www.micrel.com>

Micrel, Inc. is a leading global manufacturer of IC solutions for the worldwide high performance linear and power, LAN, and timing & communications markets. The Company's products include advanced mixed-signal, analog & power semiconductors; high-performance communication, clock management, MEMs-based clock oscillators & crystal-less clock generators, Ethernet switches, and physical layer transceiver ICs. Company customers include leading manufacturers of enterprise, consumer, industrial, mobile, telecommunications, automotive, and computer products. Corporation headquarters and state-of-the-art wafer fabrication facilities are located in San Jose, CA, with regional sales and support offices and advanced technology design centers situated throughout the Americas, Europe, and Asia. Additionally, the Company maintains an extensive network of distributors and reps worldwide.

Micrel makes no representations or warranties with respect to the accuracy or completeness of the information furnished in this datasheet. This information is not intended as a warranty and Micrel does not assume responsibility for its use. Micrel reserves the right to change circuitry, specifications and descriptions at any time without notice. No license, whether express, implied, arising by estoppel or otherwise, to any intellectual property rights is granted by this document. Except as provided in Micrel's terms and conditions of sale for such products, Micrel assumes no liability whatsoever, and Micrel disclaims any express or implied warranty relating to the sale and/or use of Micrel products including liability or warranties relating to fitness for a particular purpose, merchantability, or infringement of any patent, copyright, or other intellectual property right.

Micrel Products are not designed or authorized for use as components in life support appliances, devices or systems where malfunction of a product can reasonably be expected to result in personal injury. Life support devices or systems are devices or systems that (a) are intended for surgical implant into the body or (b) support or sustain life, and whose failure to perform can be reasonably expected to result in a significant injury to the user. A Purchaser's use or sale of Micrel Products for use in life support appliances, devices or systems is a Purchaser's own risk and Purchaser agrees to fully indemnify Micrel for any damages resulting from such use or sale.

© 2010 Micrel, Incorporated.

Looking for pricing, stock, or lifecycle information?

Click below to explore more details on WIN SOURCE:

- ⊖ [View MIC803-26D3VM3-TR on WIN SOURCE](#)
- ⊖ [Microchip Technology](#) Information

Optimize Your Supply Chain with WIN SOURCE Solutions

- ✓ Global Sourcing Solution
- ✓ Obsolete Management
- ✓ Cost Control Management
- ✓ Shortage Management
- ✓ Alternative Solution
- ✓ Excess Inventory Management