



**THE DATASHEET OF
CLC2059ISO8X**



COMLINEAR® CLC2059

Dual, Low Noise, 4V to 36V Amplifier

FEATURES

- Unity gain stable
- 110dB voltage gain
- $0.7\mu\text{V}_{\text{RMS}}$ (RIAA)
- 0.0005% THD
- 15MHz gain bandwidth product
- 7V/ μs slew rate
- 110dB power supply rejection ratio
- 110dB common mode rejection ratio
- 4V to 36V single supply voltage range
- $\pm 2\text{V}$ to $\pm 18\text{V}$ dual supply voltage range
- CLC2059: improved replacement for OP275 and NJM4580
- CLC2059: Pb-free SOIC-8

APPLICATIONS

- Active Filters
- Audio Pre-Amplifiers
- Audio AC-3 Decoder Systems
- Headphone Amplifier
- General purpose dual amplifier

General Description

The COMLINEAR CLC2059 is a low noise, dual voltage feedback amplifier that is internally frequency compensated to provide unity gain stability. The CLC2059 offers 13.7MHz of unity gain bandwidth and excellent (110dB) CMRR, PSRR, and open loop gain. The CLC2059 also features low input voltage noise ($0.7\mu\text{V}_{\text{RMS}}$) and low distortion (0.0005%) making it well suited for audio applications to improve tone control. Other applications include industrial measurement tools, pre-amplifiers, and other circuits that require well-matched channels.

The COMLINEAR CLC2059 is designed to operate over a wide power supply voltage range, $\pm 2\text{V}$ to $\pm 18\text{V}$ (4V to 36V). It utilizes an industry standard dual amplifier pin-out and is available in a Pb-free, RoHS compliant SOIC-8 package.

Typical Application - Audio Tone Control Circuit

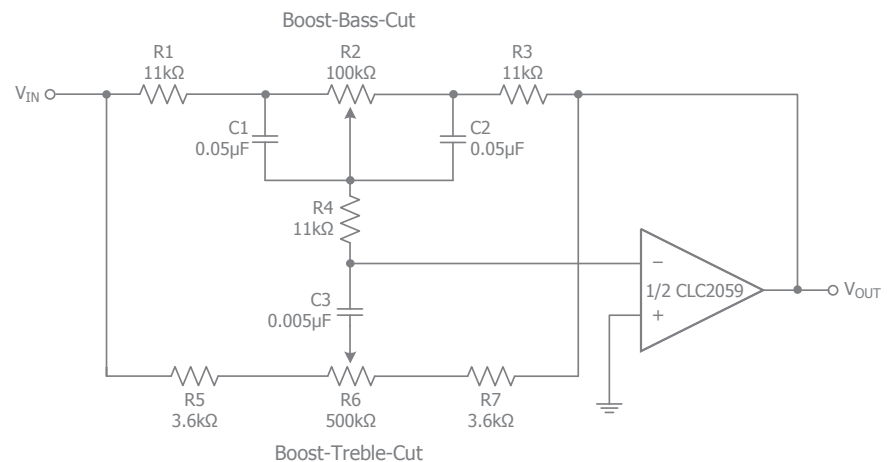

Ordering Information

| Part Number | Package | Pb-Free | RoHS Compliant | Operating Temperature Range | Packaging Method |
|--------------|---------|---------|----------------|-----------------------------|------------------|
| CLC2059ISO8X | SOIC-8 | Yes | Yes | -40°C to +85°C | Reel |

Moisture sensitivity level for all parts is MSL-1.



CLC2059 Pin Configuration

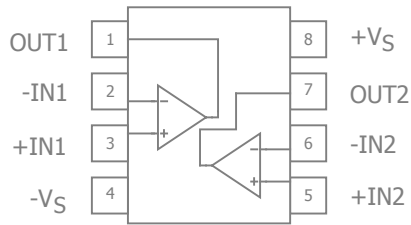

CLC2059 Pin Description

| Pin No. | Pin Name | Description |
|---------|----------|---------------------------|
| 1 | OUT1 | Output, channel 1 |
| 2 | -IN1 | Negative input, channel 1 |
| 3 | +IN1 | Positive input, channel 1 |
| 4 | -VS | Negative supply |
| 5 | +IN2 | Positive input, channel 2 |
| 6 | -IN2 | Negative input, channel 2 |
| 7 | OUT2 | Output, channel 2 |
| 8 | +VS | Positive supply |



Absolute Maximum Ratings

The safety of the device is not guaranteed when it is operated above the "Absolute Maximum Ratings". The device should not be operated at these "absolute" limits. Adhere to the "Recommended Operating Conditions" for proper device function. The information contained in the Electrical Characteristics tables and Typical Performance plots reflect the operating conditions noted on the tables and plots.

| Parameter | Min | Max | Unit |
|---|-----|-----------------|------|
| Supply Voltage | 0 | 40 (± 20) | V |
| Differential Input Voltage | | 60 (± 30) | V |
| Input Voltage | | 30 (± 15) | V |
| Power Dissipation ($T_A = 25^\circ\text{C}$) - SOIC-8 | | 500 | mW |

Reliability Information

| Parameter | Min | Typ | Max | Unit |
|-----------------------------------|-----|-----|-----|---------------------------|
| Junction Temperature | | | 150 | $^\circ\text{C}$ |
| Storage Temperature Range | -65 | | 150 | $^\circ\text{C}$ |
| Lead Temperature (Soldering, 10s) | | | 260 | $^\circ\text{C}$ |
| Package Thermal Resistance | | | | |
| SOIC-8 | | 100 | | $^\circ\text{C}/\text{W}$ |

Notes:

Package thermal resistance (θ_{JA}), JEDEC standard, multi-layer test boards, still air.

Recommended Operating Conditions

| Parameter | Min | Typ | Max | Unit |
|-----------------------------|---------------|-----|-----------------|------------------|
| Operating Temperature Range | -40 | | +85 | $^\circ\text{C}$ |
| Supply Voltage Range | 4 (± 2) | | 36 (± 18) | V |



Electrical Characteristics

$T_A = 25^\circ\text{C}$, $+V_S = +15\text{V}$, $-V_S = -15\text{V}$, $R_f = R_g = 2\text{k}\Omega$, $R_L = 2\text{k}\Omega$ to $V_S/2$, $G = 2$; unless otherwise noted.

| Symbol | Parameter | Conditions | Min | Typ | Max | Units |
|---------------------------|---|--|----------|-----------------------|-----|----------------------------|
| Frequency Domain Response | | | | | | |
| UGBW _{SS} | Unity Gain Bandwidth | $G = +1$, $V_{\text{OUT}} = 0.2V_{\text{pp}}$, $V_S = 5\text{V}$, $R_f = 0$ | | 11.7 | | MHz |
| | | $G = +1$, $V_{\text{OUT}} = 0.2V_{\text{pp}}$, $V_S = 30\text{V}$, $R_f = 0$ | | 13.7 | | MHz |
| BW _{SS} | -3dB Bandwidth | $G = +2$, $V_{\text{OUT}} = 0.2V_{\text{pp}}$, $V_S = 5\text{V}$ | | 6.3 | | MHz |
| | | $G = +1$, $V_{\text{OUT}} = 0.2V_{\text{pp}}$, $V_S = 30\text{V}$ | | 6.8 | | MHz |
| BW _{LS} | Large Signal Bandwidth | $G = +2$, $V_{\text{OUT}} = 1V_{\text{pp}}$, $V_S = 5\text{V}$ | | 2.8 | | MHz |
| | | $G = +2$, $V_{\text{OUT}} = 2V_{\text{pp}}$, $V_S = 30\text{V}$ | | 1.7 | | MHz |
| GBWP | Gain-Bandwidth Product | | | 15 | | MHz |
| Time Domain Response | | | | | | |
| t_R , t_F | Rise and Fall Time | $V_{\text{OUT}} = 0.2\text{V}$ step; (10% to 90%), $V_S = 5\text{V}$ | | 50 | | ns |
| | | $V_{\text{OUT}} = 0.2\text{V}$ step; (10% to 90%), $V_S = 30\text{V}$ | | 47 | | ns |
| OS | Overshoot | $V_{\text{OUT}} = 0.2\text{V}$ step | | 16 | | % |
| | | $V_{\text{OUT}} = 2\text{V}$ step | | 5 | | % |
| SR | Slew Rate | 2V step, $V_S = 5\text{V}$ | | 6 | | V/ μs |
| | | 4V step, $V_S = 30\text{V}$ | | 7 | | V/ μs |
| Distortion/Noise Response | | | | | | |
| THD | Total Harmonic Distortion | $V_{\text{OUT}} = 5\text{V}$, $f = 1\text{kHz}$, $G = 20\text{dB}$ | | 0.0005 | | % |
| e_n | Input Voltage Noise | > 1kHz | | 4 | | nV/ $\sqrt{\text{Hz}}$ |
| | | RIAA, 30kHz LPF, $R_S = 50\Omega$ | | 0.7 | | μV_{RMS} |
| X_{TALK} | Crosstalk | Channel-to-channel, 500kHz, $V_S = 5\text{V}$ to 30V | | 67 | | dB |
| DC Performance | | | | | | |
| V_{IO} | Input Offset Voltage ⁽¹⁾ | $R_S \leq 10\text{k}\Omega$ | | 0.5 | 3 | mV |
| I_b | Input Bias Current ⁽¹⁾ | $V_{\text{CM}} = 0\text{V}$ | | 150 | 500 | nA |
| I_{OS} | Input Offset Current ⁽¹⁾ | $V_{\text{CM}} = 0\text{V}$ | | 5 | 100 | nA |
| PSRR | Power Supply Rejection Ratio ⁽¹⁾ | $R_S \leq 10\text{k}\Omega$ | 80 | 110 | | dB |
| A_{OL} | Open-Loop Gain ⁽¹⁾ | $R_L = \geq 2\text{k}\Omega$, $V_{\text{OUT}} = \pm 10\text{V}$ | 90 | 110 | | dB |
| I_S | Supply Current ⁽¹⁾ | Total, $R_L = \infty$ | | 3 | 7 | mA |
| Input Characteristics | | | | | | |
| CMIR | Common Mode Input Range ⁽¹⁾ | $+V_S = 15\text{V}$, $-V_S = -15\text{V}$ | ± 12 | ± 13.5 | | V |
| CMRR | Common Mode Rejection Ratio ⁽¹⁾ | DC, $V_{\text{CM}} = 0\text{V}$ to $+V_S - 1.5\text{V}$, $R_S \leq 10\text{k}\Omega$ | 80 | 110 | | dB |
| Output Characteristics | | | | | | |
| V_{OUT} | Output Voltage Swing | $R_L = 2\text{k}\Omega$ | | +13.8, -13.0 | | V |
| | | $R_L = 10\text{k}\Omega$ | | ± 14.0 , -13.3 | | V |
| I_{SOURCE} | Output Current, Sourcing | $V_{\text{IN}+} = 1\text{V}$, $V_{\text{IN}-} = 0\text{V}$, $V_{\text{OUT}} = 2\text{V}$ | | 45 | | mA |
| I_{SINK} | Output Current, Sinking | $V_{\text{IN}+} = 0\text{V}$, $V_{\text{IN}-} = 1\text{V}$, $V_{\text{OUT}} = 2\text{V}$ | | 80 | | mA |

Notes:

- 100% tested at 25°C at $V_S = \pm 15\text{V}$.

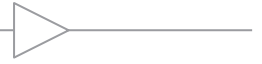

Typical Performance Characteristics

$T_A = 25^\circ\text{C}$, $+V_S = +15\text{V}$, $-V_S = -15\text{V}$, $R_f = R_g = 2\text{k}\Omega$, $R_L = 2\text{k}\Omega$ to $V_S/2$, $G = 2$; unless otherwise noted.

Non-Inverting Frequency Response

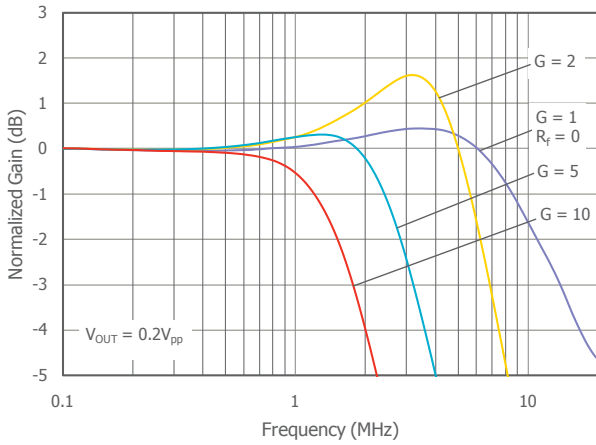

Inverting Frequency Response

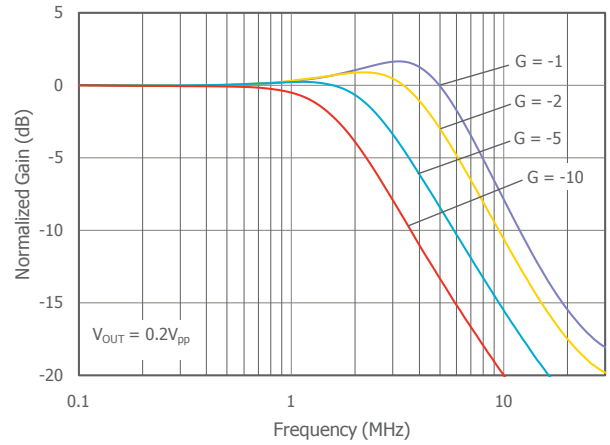

Large Signal Frequency Response

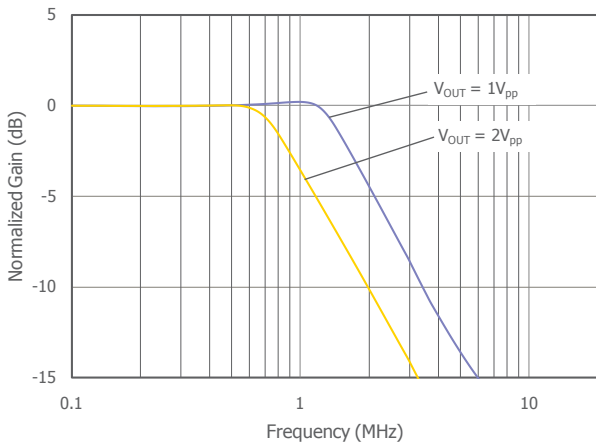

-3dB Bandwidth vs. V_{OUT}

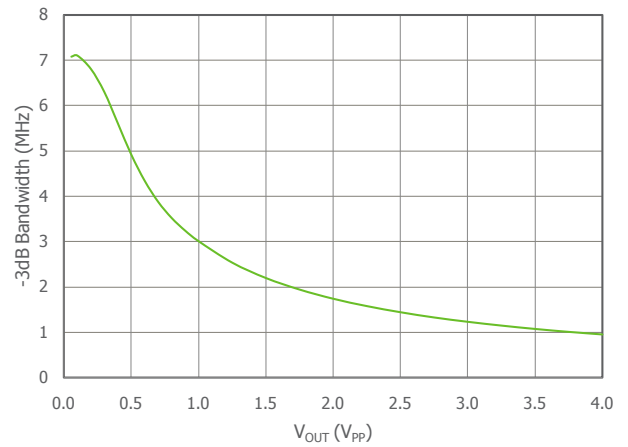

Small Signal Pulse Response

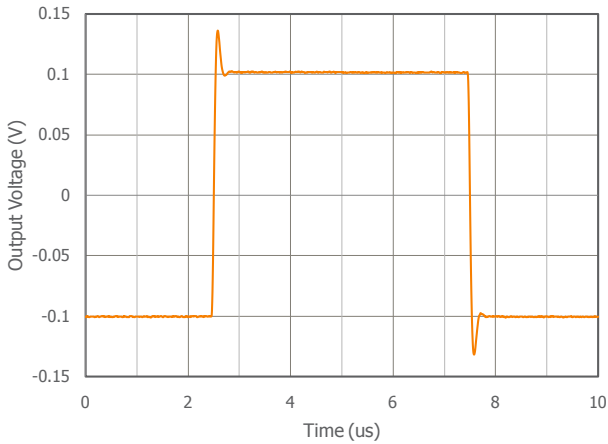

Large Signal Pulse Response

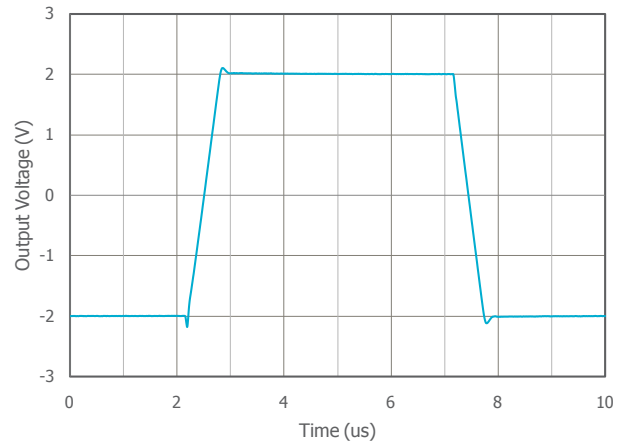



Typical Performance Characteristics

$T_A = 25^\circ\text{C}$, $+V_S = +5\text{V}$, $-V_S = \text{GND}$, $R_f = R_g = 2\text{k}\Omega$, $R_L = 2\text{k}\Omega$ to $V_S/2$, $G = 2$; unless otherwise noted.

Non-Inverting Frequency Response

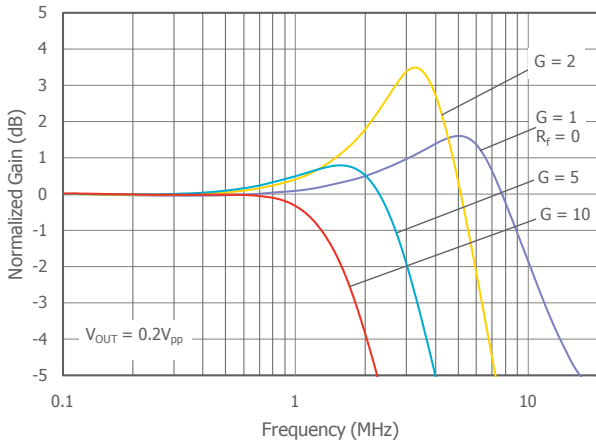

Inverting Frequency Response

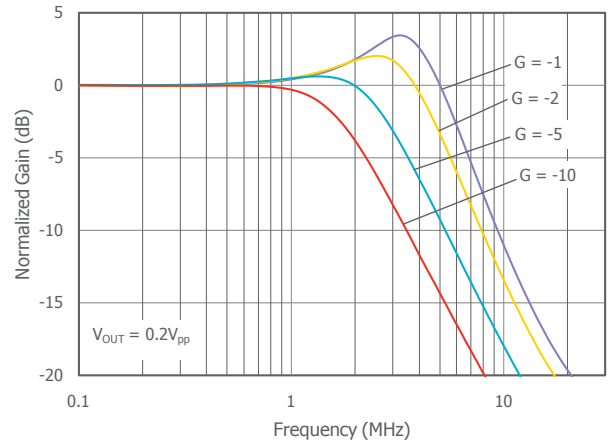

Large Signal Frequency Response

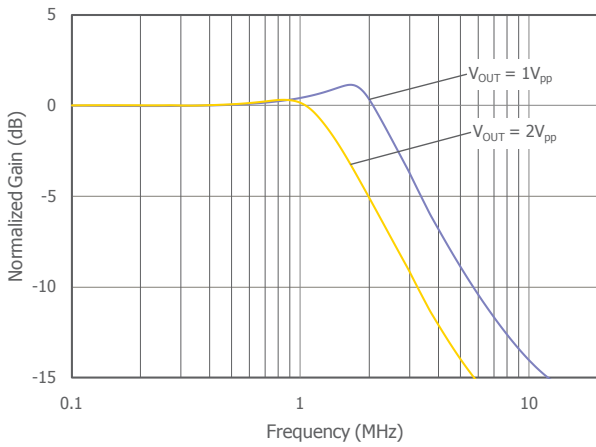

-3dB Bandwidth vs. V_OUT

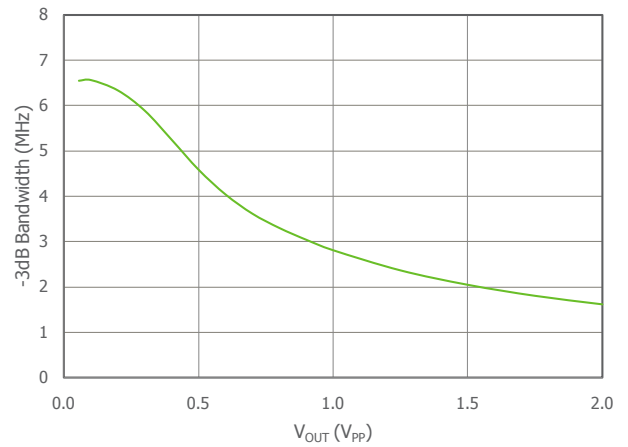

Small Signal Pulse Response

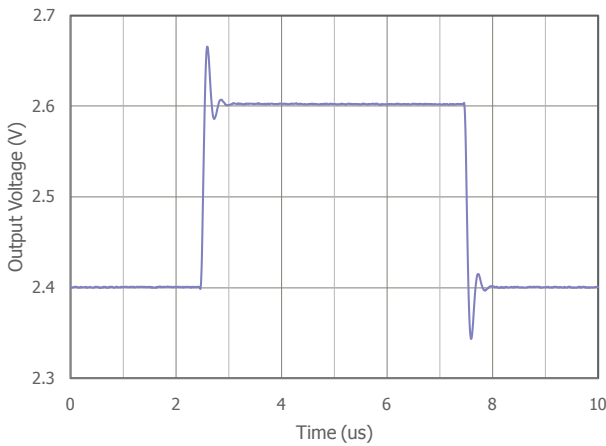

Large Signal Pulse Response

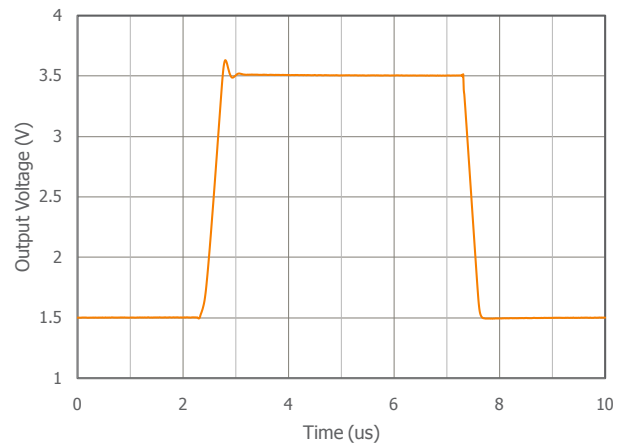



Typical Performance Characteristics

$T_A = 25^\circ\text{C}$, $+V_S = +15\text{V}$, $-V_S = -15\text{V}$, $R_f = R_g = 2\text{k}\Omega$, $R_L = 2\text{k}\Omega$ to $V_S/2$, $G = 2$; unless otherwise noted.

Open Loop Voltage Gain vs. Frequency

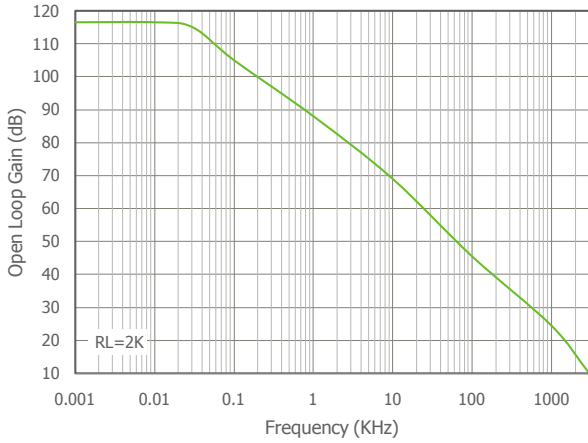

Input Voltage Noise vs. Frequency

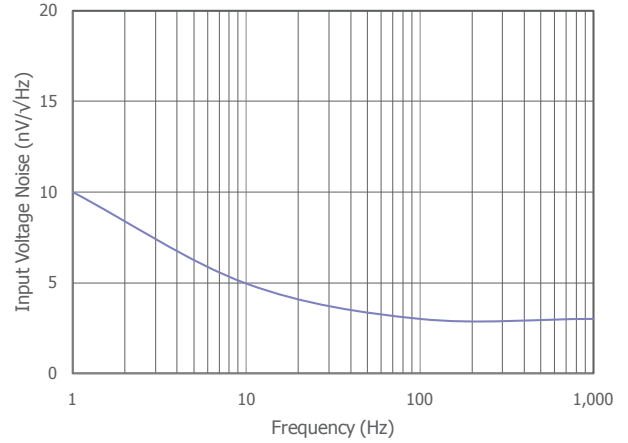

Maximum Output Voltage Swing vs. Frequency

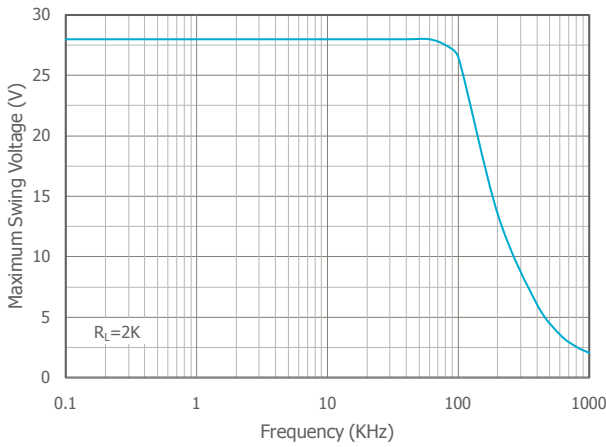

Maximum Output Voltage Swing vs. R_L

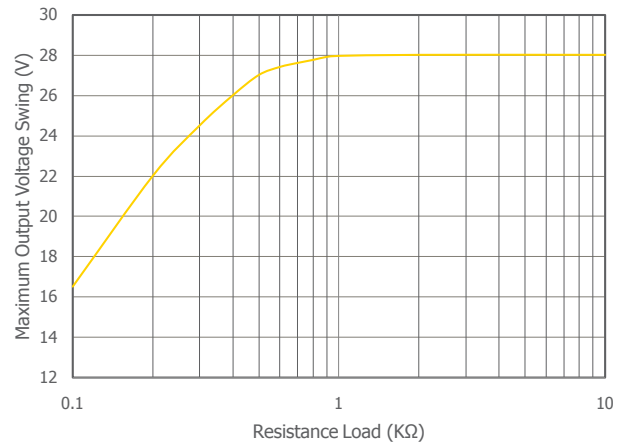

Input Offset Voltage vs. Temperature

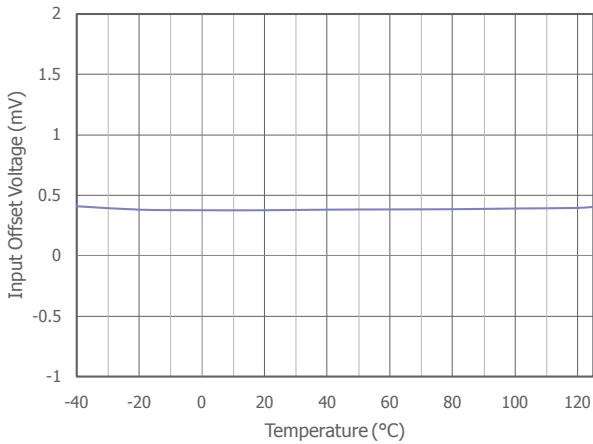

Input Bias Current vs. Temperature

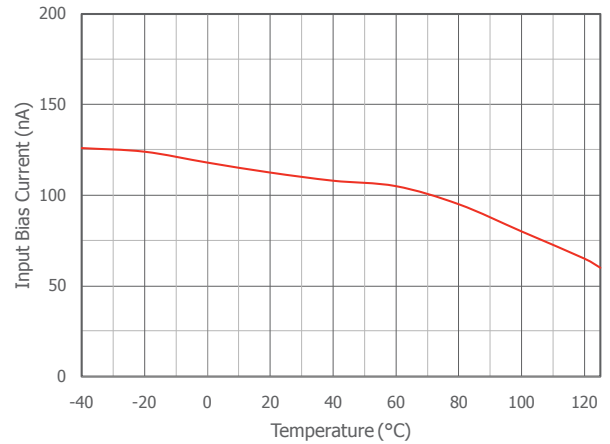



Typical Performance Characteristics

$T_A = 25^\circ\text{C}$, $+V_S = +15\text{V}$, $-V_S = -15\text{V}$, $R_f = R_g = 2\text{k}\Omega$, $R_L = 2\text{k}\Omega$ to $V_S/2$, $G = 2$; unless otherwise noted.

Supply Voltage vs. Supply Current

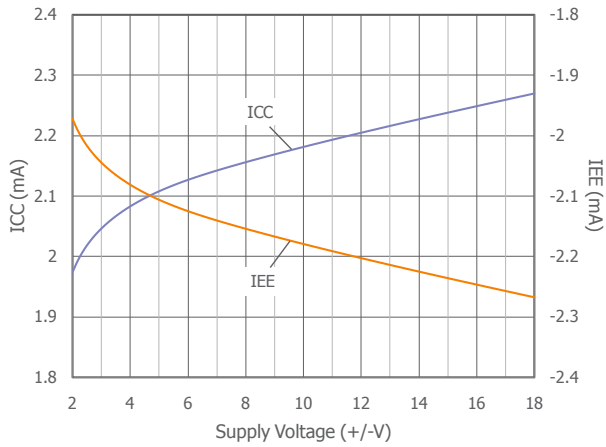

Crosstalk vs. Frequency

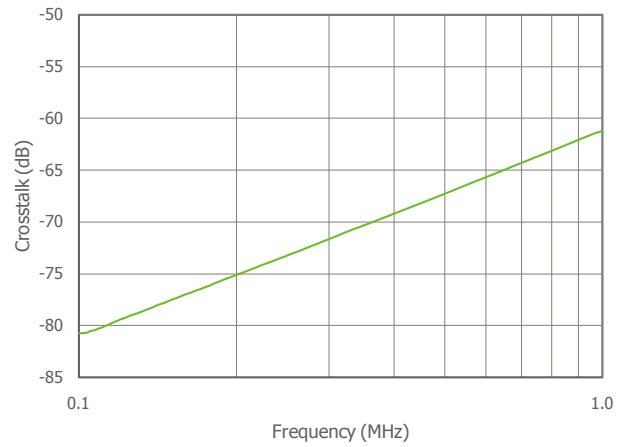

Functional Block Diagram

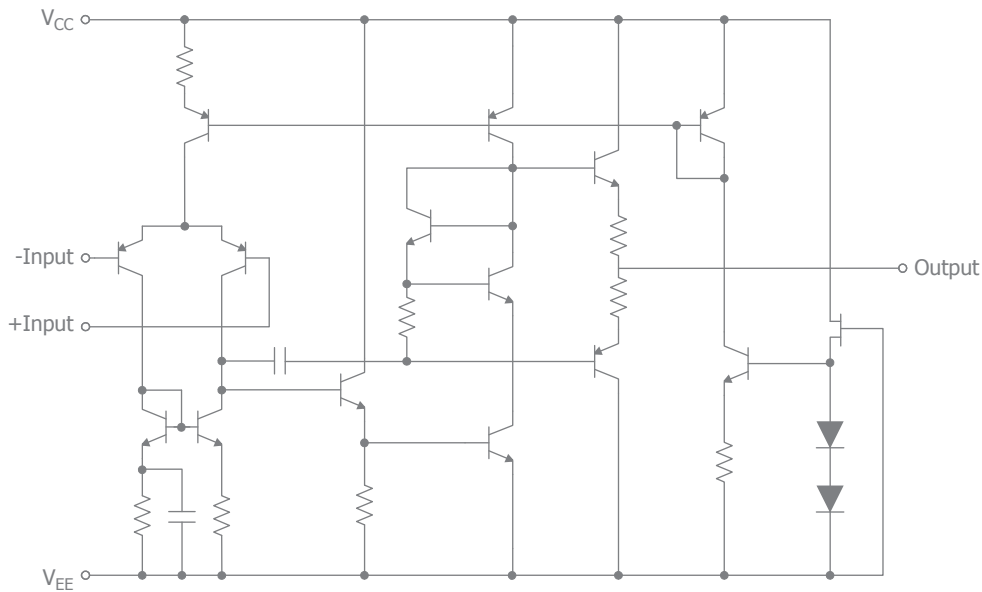



Application Information

Basic Operation

Figures 1 and 2 illustrate typical circuit configurations for non-inverting, inverting, and unity gain topologies for dual supply applications. They show the recommended bypass capacitor values and overall closed loop gain equations.

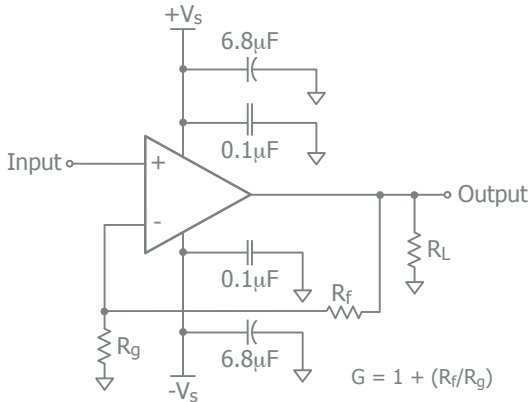

Figure 1. Typical Non-Inverting Gain Circuit

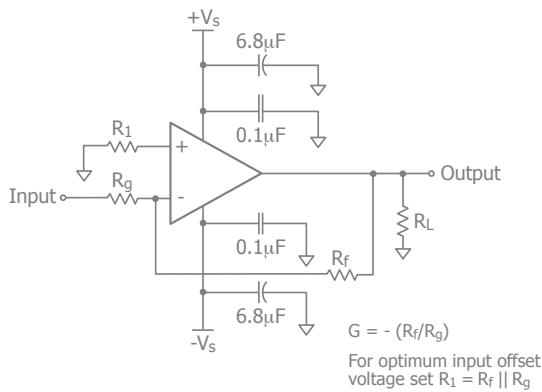

Figure 2. Typical Inverting Gain Circuit

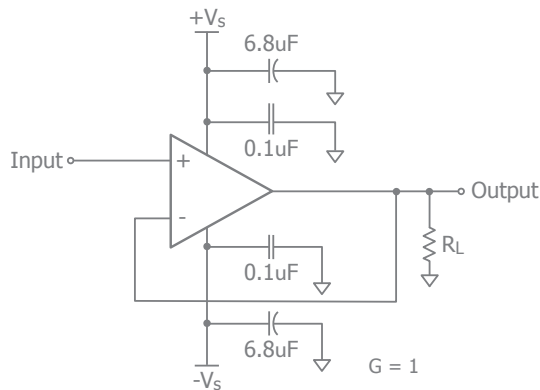

Figure 3. Unity Gain Circuit

Power Dissipation

Power dissipation should not be a factor when operating under the stated 2k ohm load condition. However, applications with low impedance, DC coupled loads should be analyzed to ensure that maximum allowed junction temperature is not exceeded. Guidelines listed below can be used to verify that the particular application will not cause the device to operate beyond its intended operating range.

Maximum power levels are set by the absolute maximum junction rating of 150°C. To calculate the junction temperature, the package thermal resistance value Θ_{JA} (Θ_{JA}) is used along with the total die power dissipation.

$$T_{\text{Junction}} = T_{\text{Ambient}} + (\Theta_{JA} \times P_D)$$

Where T_{Ambient} is the temperature of the working environment.

In order to determine P_D , the power dissipated in the load needs to be subtracted from the total power delivered by the supplies.

$$P_D = P_{\text{supply}} - P_{\text{load}}$$

Supply power is calculated by the standard power equation.

$$P_{\text{supply}} = V_{\text{supply}} \times I_{\text{RMS supply}}$$

$$V_{\text{supply}} = V_{S+} - V_{S-}$$

Power delivered to a purely resistive load is:

$$P_{\text{load}} = ((V_{\text{LOAD}})_{\text{RMS}}^2) / R_{\text{load eff}}$$

The effective load resistor ($R_{\text{load eff}}$) will need to include the effect of the feedback network. For instance,

$R_{\text{load eff}}$ in figure 3 would be calculated as:

$$R_L \parallel (R_f + R_g)$$

These measurements are basic and are relatively easy to perform with standard lab equipment. For design purposes however, prior knowledge of actual signal levels and load impedance is needed to determine the dissipated power. Here, P_D can be found from

$$P_D = P_{\text{Quiescent}} + P_{\text{Dynamic}} - P_{\text{Load}}$$

Quiescent power can be derived from the specified I_S values along with known supply voltage, V_{Supply} . Load power



can be calculated as above with the desired signal amplitudes using:

$$(V_{LOAD})_{RMS} = V_{PEAK} / \sqrt{2}$$

$$(I_{LOAD})_{RMS} = (V_{LOAD})_{RMS} / R_{load_{eff}}$$

The dynamic power is focused primarily within the output stage driving the load. This value can be calculated as:

$$P_{DYNAMIC} = (V_{S+} - V_{LOAD})_{RMS} \times (I_{LOAD})_{RMS}$$

Assuming the load is referenced in the middle of the power rails or $V_{supply}/2$.

Figure 4 shows the maximum safe power dissipation in the package vs. the ambient temperature for the packages available.

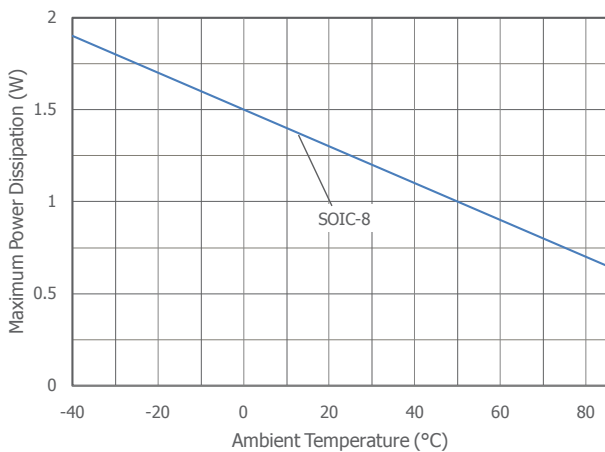

Figure 4. Maximum Power Derating

Driving Capacitive Loads

Increased phase delay at the output due to capacitive loading can cause ringing, peaking in the frequency response, and possible unstable behavior. Use a series resistance, R_S , between the amplifier and the load to help improve stability and settling performance. Refer to Figure 5.

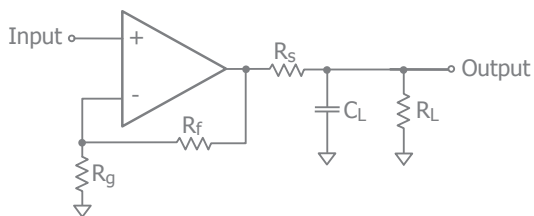

Figure 5. Addition of R_S for Driving Capacitive Loads

Overdrive Recovery

An overdrive condition is defined as the point when either one of the inputs or the output exceed their specified voltage range. Overdrive recovery is the time needed for the amplifier to return to its normal or linear operating point. The recovery time varies, based on whether the input or output is overdriven and by how much the range is exceeded. The CLC2059 will typically recover in less than $5\mu s$ from an overdrive condition. Figure 6 shows the CLC2059 in an overdriven condition.

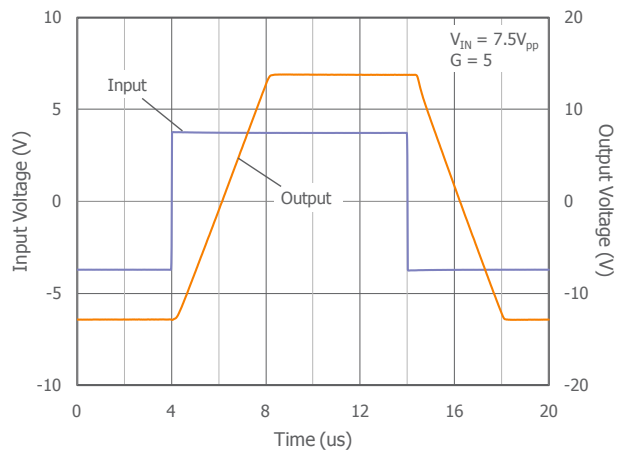

Figure 6. Overdrive Recovery

Layout Considerations

General layout and supply bypassing play major roles in high frequency performance. Exar has evaluation boards to use as a guide for high frequency layout and as an aid in device testing and characterization. Follow the steps below as a basis for high frequency layout:

- Include 6.8 μF and 0.1 μF ceramic capacitors for power supply decoupling
- Place the 6.8 μF capacitor within 0.75 inches of the power pin
- Place the 0.1 μF capacitor within 0.1 inches of the power pin
- Remove the ground plane under and around the part, especially near the input and output pins to reduce parasitic capacitance
- Minimize all trace lengths to reduce series inductances

Refer to the evaluation board layouts below for more information.

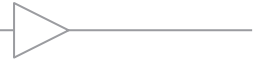

Evaluation Board Information

The following evaluation boards are available to aid in the testing and layout of these devices:

| Evaluation Board | Products |
|------------------|----------|
| CEB006 | CLC2059 |

Evaluation Board Schematics

Evaluation board schematics and layouts are shown in Figures 7-9. These evaluation boards are built for dual-supply operation. Follow these steps to use the board in a single-supply application:

1. Short -Vs to ground.
2. Use C3 and C4, if the -Vs pin of the amplifier is not directly connected to the ground plane.

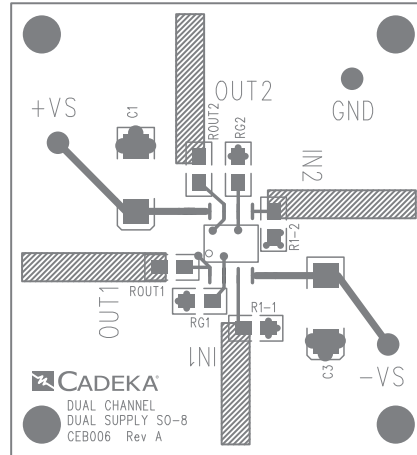

Figure 8. CEB006 Top View

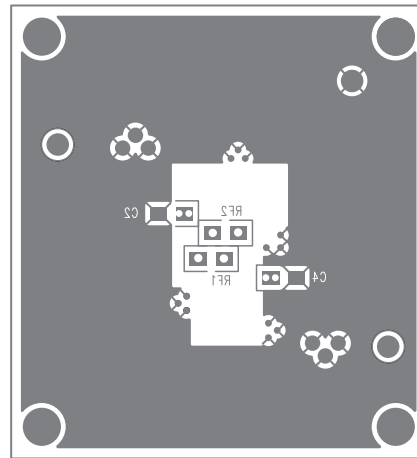

Figure 9. CEB006 Bottom View

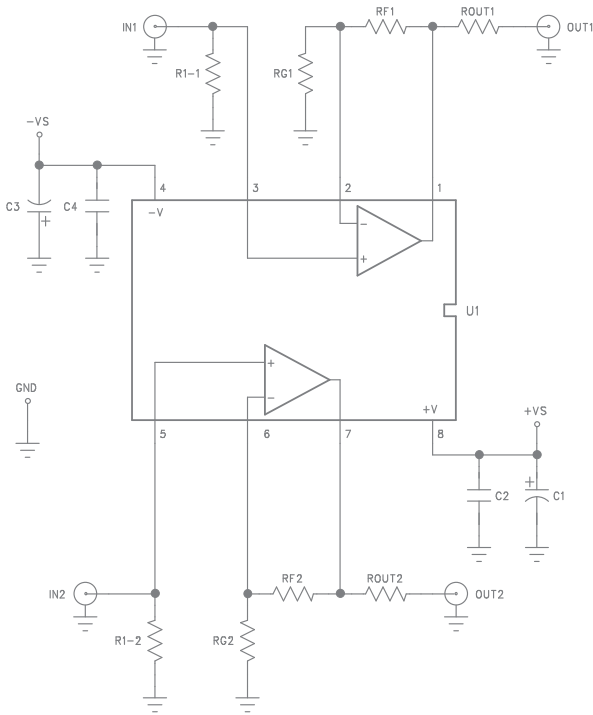

Figure 7. CEB006 Schematic



Typical Applications

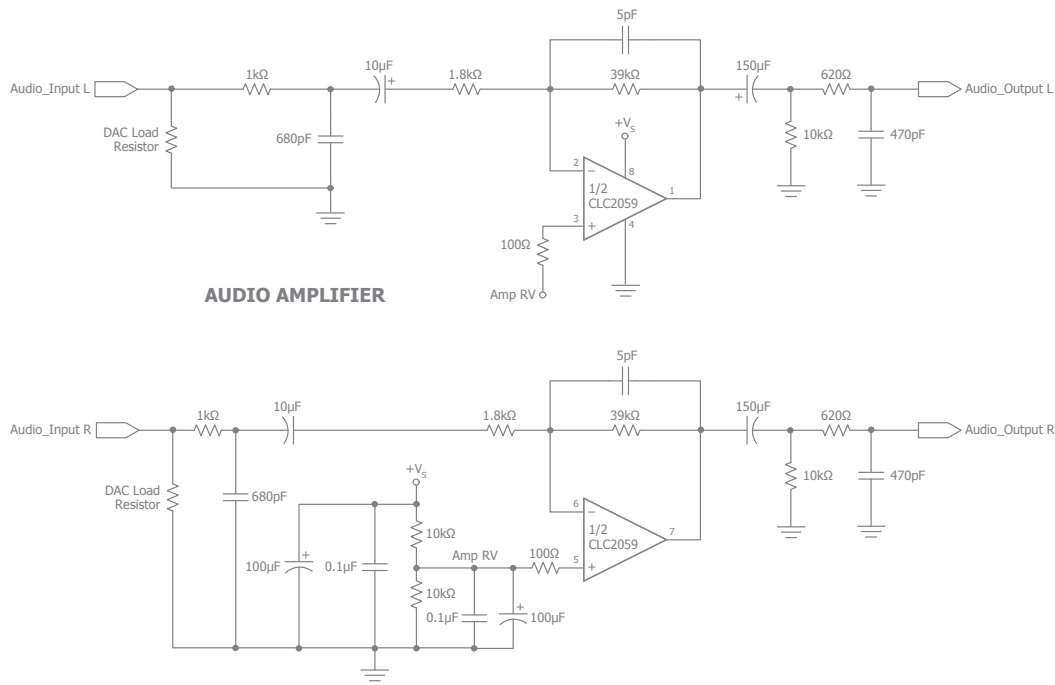

Figure 10: Typical Circuit for Filtering and Driving Audio in STB or DVD Player Applications

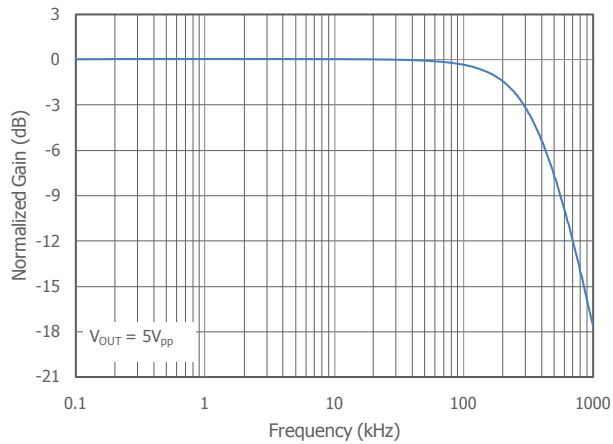

Figure 11: AC Reponse of Figure 10 ($V_S=10V$, $R_L=630\Omega$)

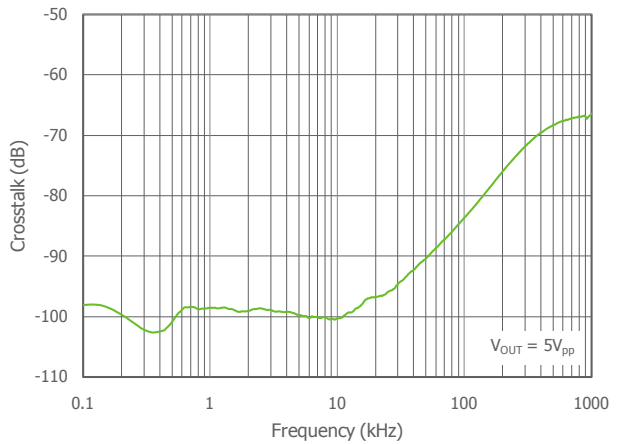
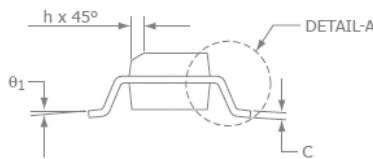
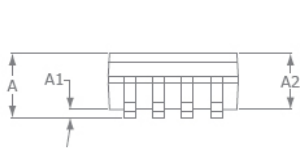
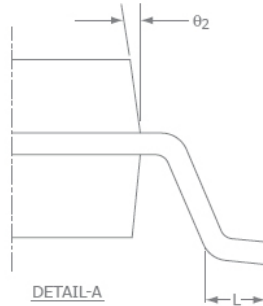
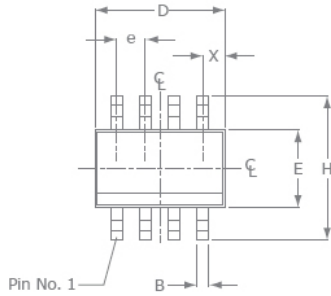

Figure 12: Cross-Talk Performance of Figure 10 ($V_S=10V$, $R_L=630\Omega$)



Mechanical Dimensions

SOIC-8 Package



| SOIC-8 | | |
|------------|----------|------|
| SYMBOL | MIN | MAX |
| A1 | 0.10 | 0.25 |
| B | 0.36 | 0.48 |
| C | 0.19 | 0.25 |
| D | 4.80 | 4.98 |
| E | 3.81 | 3.99 |
| e | 1.27 BSC | |
| H | 5.80 | 6.20 |
| h | 0.25 | 0.5 |
| L | 0.41 | 1.27 |
| A | 1.37 | 1.73 |
| θ_1 | 0° | 8° |
| X | 0.55 ref | |
| θ_2 | 7° BSC | |

NOTE:

1. All dimensions are in millimeters.
2. Lead coplanarity should be 0 to 0.1mm (0.004") max.
3. Package surface finishing: VDI 24~27
4. All dimension excluding mold flashes.
5. The lead width, B to be determined at 0.1905mm from the lead tip.

COMLINEAR CLC2059 Dual, Low Noise, 4V to 36V Amplifier Rev 1D

For Further Assistance:

Exar Corporation Headquarters and Sales Offices

48720 Kato Road
Fremont, CA 94538 - USA
Tel.: +1 (510) 668-7000
Fax: +1 (510) 668-7001
www.exar.com



A New Direction in Mixed-Signal

NOTICE
EXAR Corporation reserves the right to make changes to the products contained in this publication in order to improve design, performance or reliability. EXAR Corporation assumes no responsibility for the use of any circuits described herein, conveys no license under any patent or other right, and makes no representation that the circuits are free of patent infringement. Charts and schedules contained here in are only for illustration purposes and may vary depending upon a user's specific application. While the information in this publication has been carefully checked; no responsibility, however, is assumed for inaccuracies.

EXAR Corporation does not recommend the use of any of its products in life support applications where the failure or malfunction of the product can reasonably be expected to cause failure of the life support system or to significantly affect its safety or effectiveness. Products are not authorized for use in such applications unless EXAR Corporation receives, in writing, assurances to its satisfaction that: (a) the risk of injury or damage has been minimized; (b) the user assumes all such risks; (c) potential liability of EXAR Corporation is adequately protected under the circumstances.

Reproduction, in part or whole, without the prior written consent of EXAR Corporation is prohibited.

Looking for pricing, stock, or lifecycle information?

Click below to explore more details on WIN SOURCE:

- ⊖ [View CLC2059ISO8X on WIN SOURCE](#)
- ⊖ [Exar Corporation](#) Information

Optimize Your Supply Chain with WIN SOURCE Solutions

- ✓ Global Sourcing Solution
- ✓ Obsolete Management
- ✓ Cost Control Management
- ✓ Shortage Management
- ✓ Alternative Solution
- ✓ Excess Inventory Management