

! Partly To Be Discontinued
Last time buy: September 30, 2013

For board-to-board | For board-to-FPC

Narrow pitch connectors (0.4mm pitch)

P4 Series



• Without soldering terminals

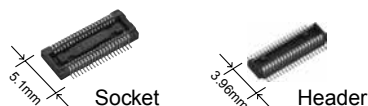

• With soldering terminals

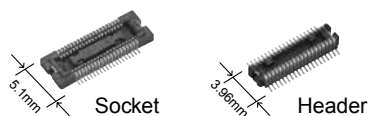

RoHS compliant

FEATURES

1. 0.4 mm pitch and mated heights of 1.5 mm, 2.0 mm, 2.5 mm, 3.0 mm, 3.5 mm, and 4.0 mm.
2. Strong resistance to adverse environments! Utilizes **“TOUGH CONTACT”** construction for high contact reliability.
3. Constructed with impact dispersion keys inside the body to disperse shocks when dropped.

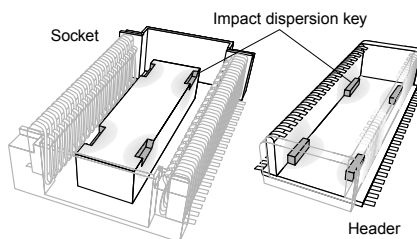

A high level of shock resistance is ensured by dispersing impact over the four locations where the socket indentations and header protrusions are mated together.

Note: The following number of pins are not supported due to suction surface factors.

- Without soldering terminals:
18 pin contacts or less
- With soldering terminals:
22 pin contacts or less

4. Construction makes designing devices easier.

1) The lower connector bottom surface construction prevents contact and shorts between the PCB and metal terminals. This enables freedom in pattern wiring, helping to make PCB's smaller.

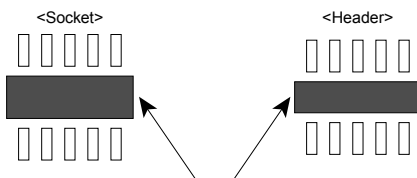

Connector bottom: Create any thru-hole and pattern wiring.

2) Guides are provided to take up any position shift and facilitate insertion.

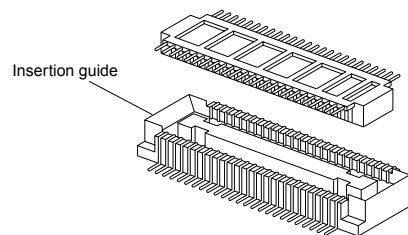

3) Simple lock structure provides tactile feedback to ensure excellent mating/unmating operation feel.

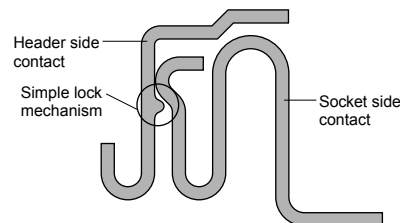

5. Design facilitates efficient mounting.

Features a terminal flatness of 0.08 mm, construction resistant to creeping flux, and design that allows visual inspection of the soldered part.

6. Connectors for inspection available

APPLICATIONS

Mobile devices, such as cellular phones, digital still cameras and digital video cameras.

ORDERING INFORMATION

AXK **G**

7: Narrow Pitch Connector P4 (0.4 mm pitch) Socket

8: Narrow Pitch Connector P4 (0.4 mm pitch) Header

Number of pins (2 digits)

Mated height

<Socket>

1: For mated height 1.5 mm

2: For mated height 2.0 mm

3: For mated height 2.5 mm and 3.0 mm

4: For mated height 3.5 mm

5: For mated height 4.0 mm

<Header>

1: For mated height 1.5 mm, 2.0 mm and 2.5 mm

2: For mated height 3.0 mm, 3.5 mm and 4.0 mm

Functions

2: With soldering terminals, without positioning bosses

4: Without soldering terminals, without positioning bosses

Surface treatment (Contact portion / Terminal portion)

<Socket>

7: Ni plating on base, Au plating on surface (for Ni barrier available)

<Header>

5: Ni plating on base, Au plating on surface

Other specifications

<Header>

W: V notch and post edge horseshoe bend type product

Packing

G: 3,000 pieces embossed tape and plastic reel × 2*

Notes: 1. Only a socket of mated height 3.5 mm and 4.0 mm: 2,000 pieces embossed tape and plastic reel × 2.

2. Please note that the models with a soldering terminals (8th digit of part number is "2") and those without a soldering terminals (8th digit of part number is "4") are shaped differently and are not compatible.

PRODUCT TYPES

1. Without soldering terminals

※ Part numbers in brackets will not be discontinued because they share a different mating height with other products.

Mated height	Number of pins	Part number		Packing	
		Socket	Header	Inner carton	Outer carton
		TOUGH CONTACT	TOUGH CONTACT		
1.5 mm	14	AXK714147G	AXK814145WG	3,000 pieces	6,000 pieces
	16	AXK716147G	AXK816145WG		
	20	AXK720147G	AXK820145WG		
	22	AXK722147G	AXK822145WG		
	24	AXK724147G	AXK824145WG		
	26	AXK726147G	AXK826145WG		
	28	AXK728147G	AXK828145WG		
	30	AXK730147G	AXK830145WG		
	34	AXK734147G	AXK834145WG		
	36	AXK736147G	AXK836145WG		
	40	AXK740147G	AXK840145WG		
	42	AXK742147G	AXK842145WG		
	44	AXK744147G	AXK844145WG		
	50	AXK750147G	AXK850145WG		
	54	AXK754147G	AXK854145WG		
	60	AXK760147G	AXK860145WG		
	64	AXK764147G	AXK864145WG		
70	AXK770147G	AXK870145WG			
80	AXK780147G	AXK880145WG			
90	AXK790147G	AXK890145WG			
100	AXK700147G	AXK800145WG			
2.0 mm	14	AXK714247G	AXK814145WG	3,000 pieces	6,000 pieces
	20	AXK720247G	AXK820145WG		
	24	AXK724247G	AXK824145WG		
	26	AXK726247G	AXK826145WG		
	30	AXK730247G	AXK830145WG		
	34	AXK734247G	※(AXK834145WG)		
	38	AXK738247G	AXK838145WG		
	40	AXK740247G	AXK840145WG		
	50	AXK750247G	AXK850145WG		
	54	AXK754247G	※(AXK854145WG)		
	60	AXK760247G	AXK860145WG		
70	AXK770247G	AXK870145WG			
80	AXK780247G	AXK880145WG			
100	AXK700247G	※(AXK800145WG)			
2.5 mm	14	AXK714347G	AXK814145WG	3,000 pieces	6,000 pieces
	20	AXK720347G	AXK820145WG		
	24	AXK724347G	AXK824145WG		
	30	AXK730347G	AXK830145WG		
	34	AXK734347G	※(AXK834145WG)		
	40	AXK740347G	AXK840145WG		
	44	AXK744347G	※(AXK844145WG)		
	50	AXK750347G	AXK850145WG		
	60	AXK760347G	AXK860145WG		
	70	AXK770347G	AXK870145WG		
	80	AXK780347G	AXK880145WG		
90	AXK790347G	AXK890145WG			
100	AXK700347G	※(AXK800145WG)			
3.0 mm	20	AXK720347G	AXK820245WG	Socket: 2,000 pieces Header: 3,000 pieces	Socket: 4,000 pieces Header: 6,000 pieces
	24	AXK724347G	AXK824245WG		
	30	AXK730347G	AXK830245WG		
	40	AXK740347G	AXK840245WG		
	50	AXK750347G	AXK850245WG		
	60	AXK760347G	AXK860245WG		
	80	AXK780347G	AXK880245WG		
	100	AXK700347G	AXK800245WG		
3.5 mm	20	AXK720447G	AXK820245WG	Socket: 2,000 pieces Header: 3,000 pieces	Socket: 4,000 pieces Header: 6,000 pieces
	30	AXK730447G	AXK830245WG		
	40	AXK740447G	AXK840245WG		
4.0 mm	24	AXK724547G	※(AXK824245WG)		

- Notes: 1. Regarding ordering units; During production: Please make orders in 1-reel units.
 Samples for mounting confirmation: Available in units of 50 pieces. Please consult us. (See "Regarding sample orders to confirm proper mounting" on page 169.)
 Samples: Small lot orders are possible.
2. The above part numbers are for connectors without positioning bosses, which are standard. When ordering connectors with positioning bosses, please contact our sales office.
3. Different number of pins are available on-demand production only. Please contact us for more details.

2. With soldering terminals **TOUGH CONTACT**

※ Part numbers in brackets will not be discontinued because they share a different mating height with other products.

Mated height	Number of pins	Part number		Packing		
		Socket TOUGH CONTACT	Header TOUGH CONTACT	Inner carton	Outer carton	
1.5 mm	10	AXK710127G	AXK810125WG	3,000 pieces	6,000 pieces	
	12	AXK712127G	※(AXK812125WG)			
	20	AXK720127G	※(AXK820125WG)			
	22	AXK722127G	AXK822125WG			
	24	AXK724127G	AXK824125WG			
	28	AXK728127G	AXK828125WG			
	30	AXK730127G	AXK830125WG			
	34	AXK734127G	AXK834125WG			
	36	AXK736127G	AXK836125WG			
	40	AXK740127G	AXK840125WG			
	44	AXK744127G	AXK844125WG			
	46	AXK746127G	AXK846125WG			
	50	AXK750127G	AXK850125WG			
	60	AXK760127G	AXK860125WG			
2.0 mm	20	AXK720227G	※(AXK820125WG)	3,000 pieces	6,000 pieces	
	24	AXK724227G	AXK824125WG			
	30	AXK730227G	AXK830125WG			
	34	AXK734227G	AXK834125WG			
	40	AXK740227G	※(AXK840125WG)			
	50	AXK750227G	AXK850125WG			
	60	AXK760227G	AXK860125WG			
	80	AXK780227G	AXK880125WG			
2.5 mm	12	AXK712327G	AXK812125WG	3,000 pieces	6,000 pieces	
	20	AXK720327G	AXK820125WG			
	28	AXK728327G	AXK828125WG			
	32	AXK732327G	AXK832125WG			
	36	※(AXK736327G)	AXK836125WG			
	40	AXK740327G	AXK840125WG			
	50	AXK750327G	AXK850125WG			
	60	※(AXK760327G)	AXK860125WG			
3.0 mm	80	※(AXK780327G)	AXK880125WG	3,000 pieces	6,000 pieces	
	90	AXK790327G	AXK890125WG			
	20	AXK720327G	AXK820225WG			
	36	AXK736327G	AXK836225WG			
	40	※(AXK740327G)	AXK840225WG			
	50	AXK750327G	AXK850225WG			
	60	AXK760327G	AXK860225WG			
3.5 mm	70	AXK770327G	AXK870225WG	Socket: 2,000 pieces Header: 3,000 pieces	Socket: 4,000 pieces Header: 6,000 pieces	
	80	AXK780327G	AXK880225WG			
	90	AXK790327G	AXK890225WG			
	20	AXK720427G	※(AXK820225WG)			
	30	AXK730427G	AXK830225WG			
	40	AXK740427G	AXK840225WG			
4.0 mm	50	AXK750427G	AXK850225WG	Socket: 2,000 pieces Header: 3,000 pieces	Socket: 4,000 pieces Header: 6,000 pieces	
	60	AXK760427G	AXK860225WG			
	70	AXK770427G	AXK870225WG			
	80	AXK780427G	AXK880225WG			
	90	AXK790427G	AXK890225WG			
4.0 mm	34	AXK734527G	AXK834225WG	Socket: 2,000 pieces Header: 3,000 pieces	Socket: 4,000 pieces Header: 6,000 pieces	
	42	AXK742527G	AXK842225WG			
	50	AXK750527G	AXK850225WG			
	80	AXK780527G	※(AXK880225WG)			
		90	AXK790527G	AXK890225WG		

- Notes: 1. Regarding ordering units; During production: Please make orders in 1-reel units.
Samples for mounting confirmation: Available in units of 50 pieces. Please consult us. (See "Regarding sample orders to confirm proper mounting" on page 169.)
Samples: Small lot orders are possible.
2. The above part numbers are for connectors without positioning bosses, which are standard. When ordering connectors with positioning bosses, please contact our sales office.
3. Different number of pins are available on-demand production only. Please contact us for more details.

SPECIFICATIONS

1. Characteristics

Item		Specification	Conditions	
Electrical characteristics	Rated current	0.3A/pin contact (Max. 5 A at total pin contacts)		
	Rated voltage	60V AC/DC		
	Breakdown voltage	150V AC for 1 min.	Detection current: 1mA	
	Insulation resistance	Min. 1,000M Ω (initial)	Using 250V DC megger (applied for 1 min.)	
	Contact resistance	Max. 70m Ω	Based on the contact resistance measurement method specified by JIS C 5402.	
Mechanical characteristics	Composite insertion force	Max. 0.981N {100gf}/pin contacts \times pin contacts (initial)		
	Composite removal force	Min. 0.0588N {6gf}/pin contacts \times pin contacts (Mated height 1.5 mm without soldering terminals type) Min. 0.118N {12gf}/pin contacts \times pin contacts All the other types except the above (Mated height 1.5 mm without soldering terminals type)		
	Post holding force	Min. 0.981N {100gf}/pin contacts	Measuring the maximum force. As the contact is axially pull out.	
Environmental characteristics	Ambient temperature	-55°C to +85°C	No freezing at low temperatures	
	Soldering heat resistance	Max. peak temperature of 260°C (on the surface of the PC board around the connector terminals)	Infrared reflow soldering	
		300°C within 5 sec. 350°C within 3 sec.	Soldering iron	
	Storage temperature	-55°C to +85°C (product only) -40°C to +50°C (emboss packing)	No freezing at low temperatures. No dew condensation.	
	Thermal shock resistance (header and socket mated)	5 cycles, insulation resistance min. 100M Ω , contact resistance max. 70m Ω	Conformed to MIL-STD-202F, method 107G	
			Order	Temperature ($^{\circ}$ C)
			1	-55 $\frac{0}{-3}$
		2	}	Max. 5
		3	85 $\frac{+3}{0}$	30
		4	}	Max. 5
			-55 $\frac{0}{-3}$	
Humidity resistance (header and socket mated)	120 hours, insulation resistance min. 100M Ω , contact resistance max. 70m Ω	Bath temperature 40 \pm 2°C, humidity 90 to 95% R.H.		
Saltwater spray resistance (header and socket mated)	24 hours, insulation resistance min. 100M Ω , contact resistance max. 70m Ω	Bath temperature 35 \pm 2°C, saltwater concentration 5 \pm 1%		
H ₂ S resistance (header and socket mated)	48 hours, contact resistance max. 70m Ω	Bath temperature 40 \pm 2°C, gas concentration 3 \pm 1 ppm, humidity 75 to 80% R.H.		
Lifetime characteristics	Insertion and removal life	50 times	Repeated insertion and removal speed of max. 200 times/hours	
Unit weight	Mated height 1.5mm, 20 pin contacts; Socket: 0.04g Header: 0.02g			

2. Material and surface treatment

Part name	Material	Surface treatment
Molded portion	LCP resin (UL94V-0)	—
Contact and Post	Copper alloy	Contact portion: Ni plating on base, Au plating on surface Terminal portion: Ni plating on base, Au plating on surface (Except for thick of terminal) However, upper terminal of Ni barrier production: Exposed over Ni The area adjacent to the terminal of the sockets on models with Ni barrier is exposed to Ni on base.
Soldering terminals portion	Copper alloy	Ni plating on base, Sn plating on surface (Except for front terminal)

DIMENSIONS (Unit: mm)

The CAD data of the products with a **CAD Data** mark can be downloaded from: <http://industrial.panasonic.com/ac/e/>

1. Without Soldering Terminals

Socket (Mated height: 1.5 mm, 2.0 mm, 2.5 mm, 3.0 mm, 3.5 mm and 4.0 mm)

CAD Data

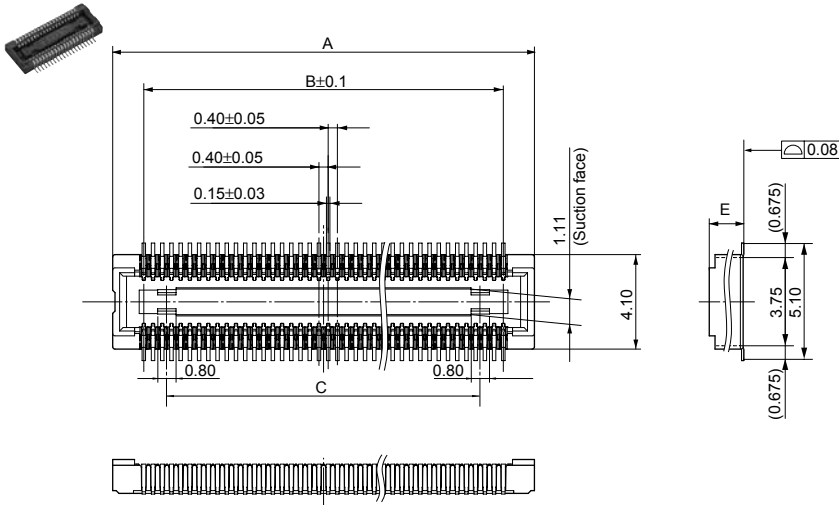

Max. 18 pin contacts

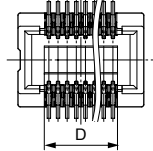

General tolerance: ±0.2

Dimension table (mm)

Number of pins/ dimension	A	B	C	D
14	5.1	2.4	—	2.8
16	5.5	2.8	—	3.2
20	6.3	3.6	1.6	—
22	6.7	4.0	2.0	—
24	7.1	4.4	2.4	—
26	7.5	4.8	2.8	—
28	7.9	5.2	3.2	—
30	8.3	5.6	3.6	—
34	9.1	6.4	4.4	—
36	9.5	6.8	4.8	—
38	9.9	7.2	5.2	—
40	10.3	7.6	5.6	—
42	10.7	8.0	6.0	—
44	11.1	8.4	6.4	—
50	12.3	9.6	7.6	—
54	13.1	10.4	8.4	—
60	14.3	11.6	9.6	—
64	15.1	12.4	10.4	—
70	16.3	13.6	11.6	—
80	18.3	15.6	13.6	—
90	20.3	17.6	15.6	—
100	22.3	19.6	17.6	—

Mated height/dimension	E
1.5mm	1.50
2.0mm	1.92
2.5mm, 3.0mm	2.42
3.5mm	2.92
4.0mm	3.42

Header (Mated height: 1.5 mm, 2.0 mm, 2.5 mm, 3.0 mm, 3.5 mm and 4.0 mm)

CAD Data

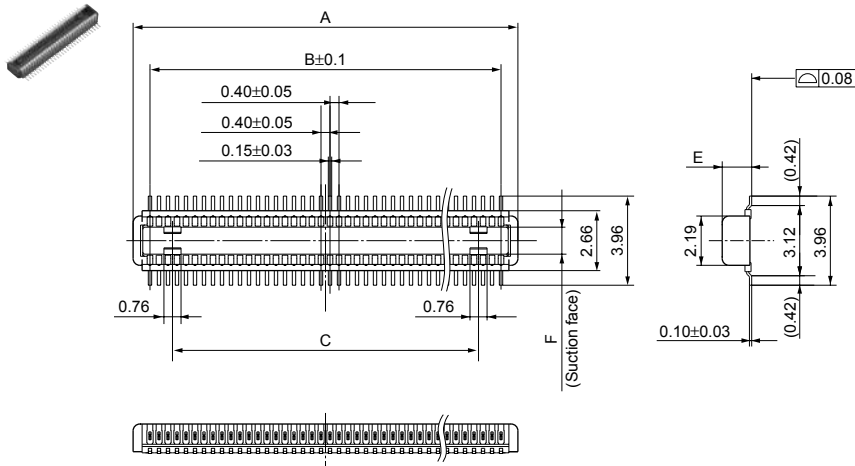

Max. 18 pin contacts

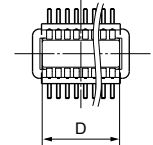

General tolerance: ±0.2

Dimension table (mm)

Number of pins/ dimension	A	B	C	D
14	3.9	2.4	—	3.04
16	4.3	2.8	—	3.44
20	5.1	3.6	1.6	—
22	5.5	4.0	2.0	—
24	5.9	4.4	2.4	—
26	6.3	4.8	2.8	—
28	6.7	5.2	3.2	—
30	7.1	5.6	3.6	—
34	7.9	6.4	4.4	—
36	8.3	6.8	4.8	—
38	8.7	7.2	5.2	—
40	9.1	7.6	5.6	—
42	9.5	8.0	6.0	—
44	9.9	8.4	6.4	—
50	11.1	9.6	7.6	—
54	11.9	10.4	8.4	—
60	13.1	11.6	9.6	—
64	13.9	12.4	10.4	—
70	15.1	13.6	11.6	—
80	17.1	15.6	13.6	—
90	19.1	17.6	15.6	—
100	21.1	19.6	17.6	—

Mated height/dimension	E	F
1.5mm, 2.0mm, 2.5mm	1.31	1.20
3.0mm, 3.5mm, 4.0mm	2.26	1.26

Socket and Header are mated

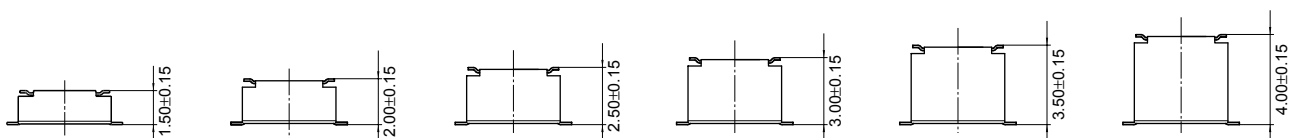

2. With Soldering Terminals

Socket (Mated height: 1.5mm, 2.0mm, 2.5mm, 3.0mm, 3.5mm and 4.0mm)

CAD Data

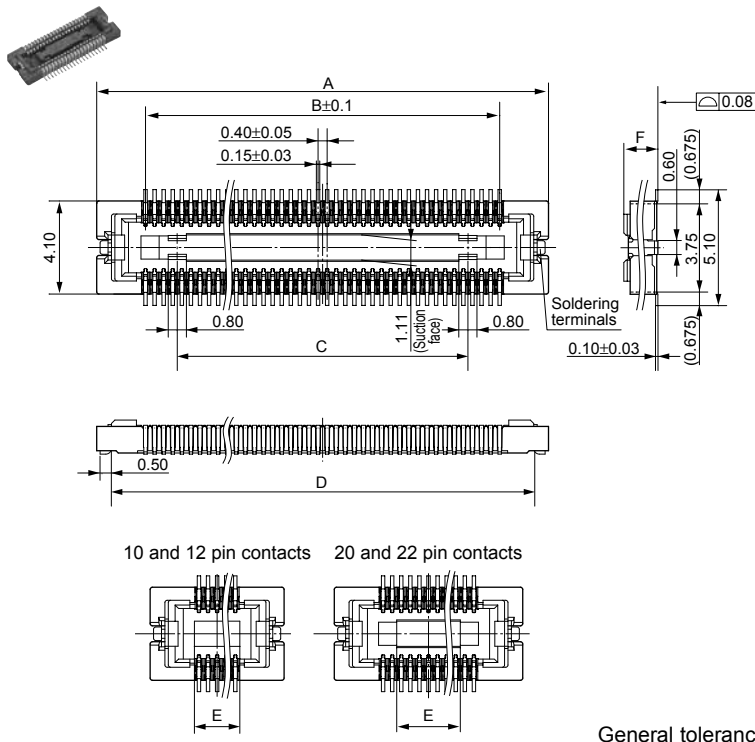

Dimension table (mm)

Number of pins/ dimension	A	B	C	D	E
10	5.90	1.60	—	4.60	2.00
12	6.30	2.00	—	5.00	2.40
20	7.90	3.60	—	6.60	2.40
22	8.30	4.00	—	7.00	2.80
24	8.70	4.40	1.60	7.40	—
28	9.50	5.20	2.40	8.20	—
30	9.90	5.60	2.80	8.60	—
32	10.30	6.00	3.20	9.00	—
34	10.70	6.40	3.60	9.40	—
36	11.10	6.80	4.00	9.40	—
40	11.90	7.60	4.80	10.60	—
42	12.30	8.00	5.20	11.00	—
44	12.70	8.40	5.60	11.40	—
46	13.10	8.80	6.00	11.80	—
50	13.90	9.60	6.80	12.60	—
60	15.90	11.60	8.80	14.60	—
70	17.90	13.60	10.80	16.60	—
80	19.90	15.60	12.80	18.60	—
90	21.90	17.60	14.80	20.60	—
100	23.90	19.60	16.80	22.60	—

Mated height/dimension	F
1.5mm	1.50
2.0mm	1.92
2.5mm, 3.0mm	2.42
3.5mm	2.92
4.0mm	3.42

General tolerance: ±0.2

Header (Mated height: 1.5mm, 2.0mm, 2.5mm, 3.0mm, 3.5mm and 4.0mm)

CAD Data

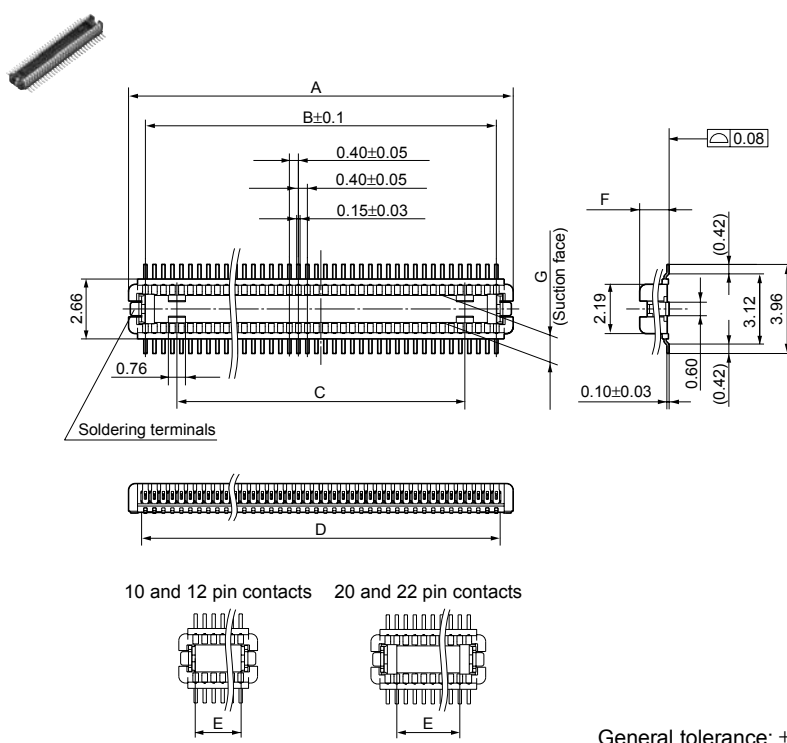

Dimension table (mm)

Number of pins/ dimension	A	B	C	D	E
10	3.10	1.60	—	1.94	1.64
12	3.50	2.00	—	2.34	2.04
20	5.10	3.60	—	3.94	2.80
22	5.50	4.00	—	4.34	3.20
24	5.90	4.40	1.60	4.74	—
28	6.70	5.20	2.40	5.54	—
30	7.10	5.60	2.80	5.94	—
32	7.50	6.00	3.20	6.34	—
34	7.90	6.40	3.60	6.74	—
36	8.30	6.80	4.00	7.14	—
40	9.10	7.60	4.80	7.94	—
42	9.50	8.00	5.20	8.34	—
44	9.90	8.40	5.60	8.74	—
46	10.30	8.80	6.00	9.14	—
50	11.10	9.60	6.80	9.94	—
60	13.10	11.60	8.80	11.94	—
70	15.10	13.60	10.80	13.94	—
80	17.10	15.60	12.80	15.94	—
90	19.10	17.60	14.80	17.94	—
100	21.10	19.60	16.80	19.94	—

Mated height/dimension	F	G
1.5mm, 2.0mm, 2.5mm	1.31	1.20
3.0mm, 3.5mm, 4.0mm	2.26	1.26

General tolerance: ±0.2

Socket and Header are mated.

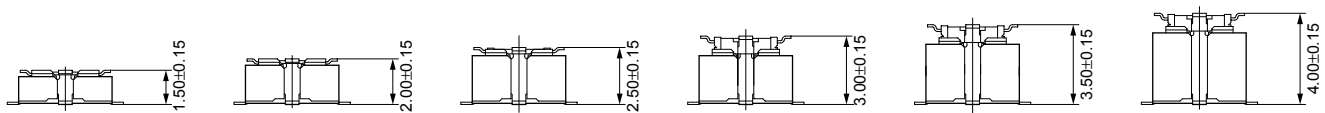

EMBOSSED TAPE DIMENSIONS (unit: mm, Common for respective contact type, socket and header)

• Tape dimensions (Conforming to JIS C 0806-1990.

• Plastic reel dimensions (Conforming to EIAJ ET-7200B)

However, some tapes have mounting hole pitches that do not comply with the standard.)

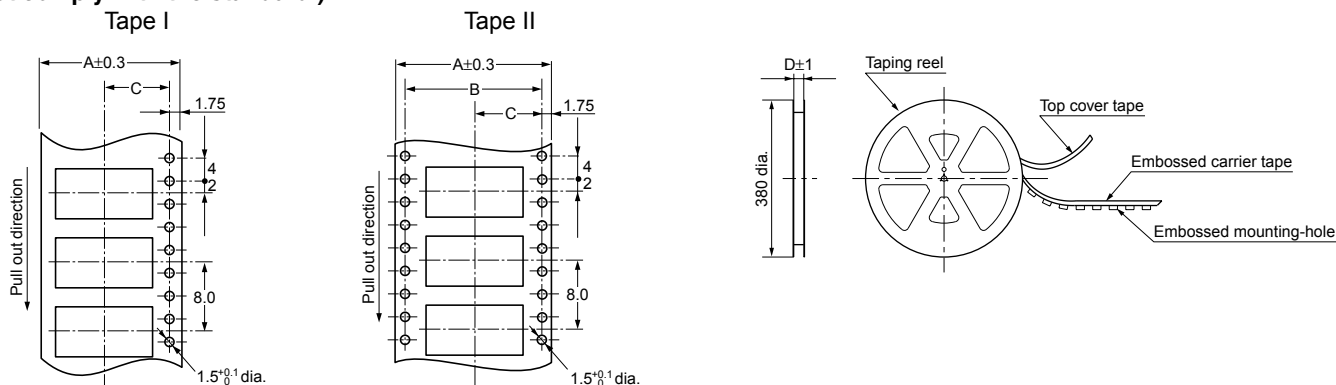

Dimension table (mm)

1. Without Soldering Terminals

Mated height	Number of pins		Type of taping	A	B	C	D	Quantity per reel
	Socket	Header						
Common for socket and header: 1.5 mm, 2.0 mm, 2.5 mm and 3.0 mm Header: 3.5mm and 4.0 mm	Max. 18	Max. 18	Tape I	16.0	—	7.5	17.4	3,000
	20 to 70	20 to 70	Tape I	24.0	—	11.5	25.4	3,000
	80 to 100	80 to 100	Tape II	32.0	28.4	14.2	33.4	3,000
	80 to 100	—	Tape II	44.0	40.4	20.2	45.4	3,000
Socket: 3.5mm and 4.0 mm	20 to 40		Tape I	24.0	—	11.5	25.4	2,000

2. With Soldering Terminals

Mated height	Number of pins		Type of taping	A	B	C	D	Quantity per reel
	Socket	Header						
Common for socket and header: 1.5 mm, 2.0 mm, 2.5 mm and 3.0 mm Header: 3.5mm and 4.0 mm	Max. 18	Max. 18	Tape I	16.0	—	7.5	17.4	3,000
	20 to 60	20 to 70	Tape I	24.0	—	11.5	25.4	3,000
	70 to 90	80 to 100	Tape II	32.0	28.4	14.2	33.4	3,000
	100	—	Tape II	44.0	40.4	20.2	45.4	3,000
Socket: 3.5mm and 4.0 mm	20 to 60		Tape I	24.0	—	11.5	25.4	2,000
	70 to 90		Tape II	32.0	28.4	14.2	33.4	2,000

3. Connector orientation with respect to direction of progress of embossed tape

1) Without soldering terminals

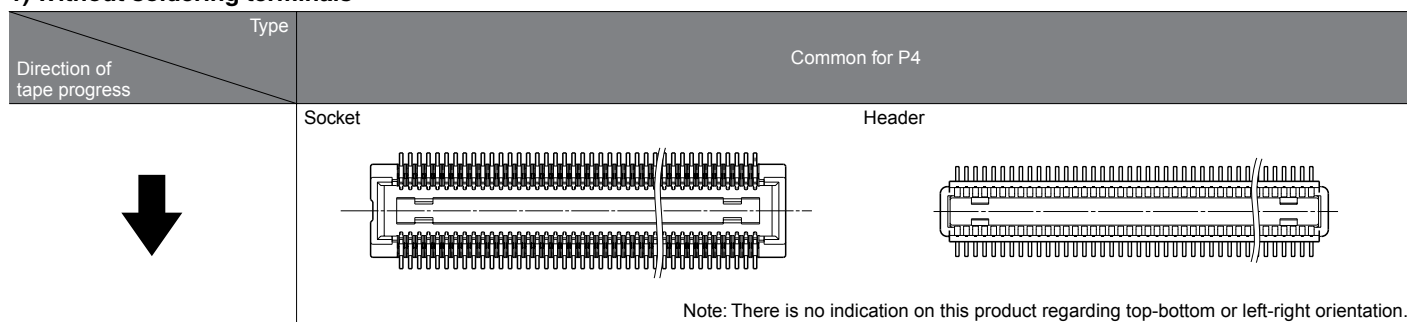

2) With soldering terminals

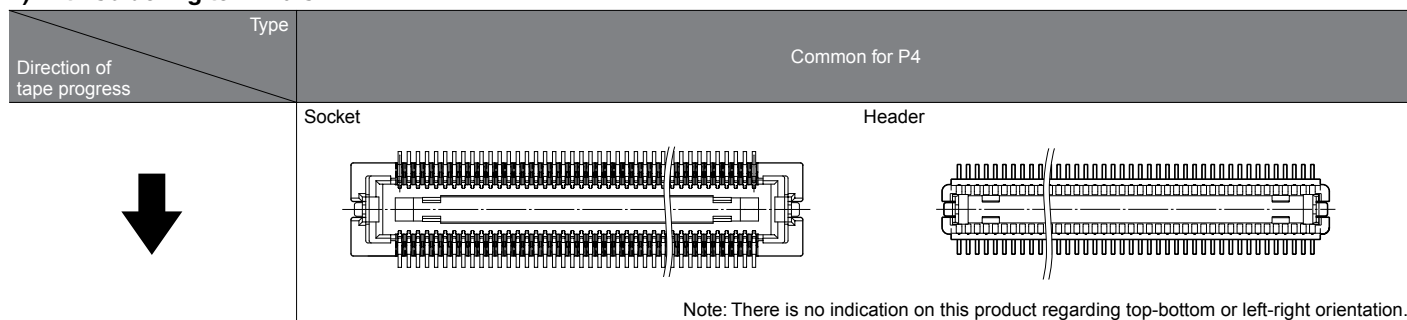

Partly To Be Discontinued
Last time buy: September 30, 2013

For board-to-board | For board-to-FPC

Connectors for inspection usage (0.4mm pitch)

P4 Series

FEATURES

- 1. 3,000 mating and unmating cycles
- 2. Same external dimensions and foot pattern as standard type.
- 3. Improved mating

Insertion and removal easy due to a reduction in mating retention force. This is made possible by a simple locking structure design.

Note: Mating retention force cannot be warranted.

APPLICATIONS

Ideal for module unit inspection and equipment assembly inspection

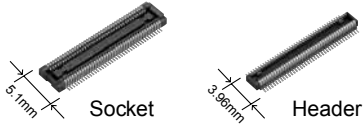

RoHS compliant

TABLE OF PRODUCT TYPES

☆: Available for sale

Product name	Number of pins																							
	10	12	14	16	20	22	24	26	28	30	34	36	40	42	44	46	50	54	60	64	70	80	90	100
P4 for inspection without soldering terminals			☆	☆	☆	☆	☆	☆	☆	☆	☆	☆	☆	☆	☆		☆	☆	☆	☆	☆	☆	☆	☆
P4 for inspection with soldering terminals	☆	☆			☆	☆	☆		☆	☆	☆		☆		☆	☆	☆		☆				☆	☆

- Notes: 1. You can use with each mated height in common. 2. Please inquire about number of pins other than those shown above. 3. Please inquire with us regarding availability. 4. Please keep the minimum order quantities no less than 50 pieces per lot. 5. Please inquire if further information is needed.

PRODUCT TYPES

Specification		Part No.	Specification		Part No.
Socket	With soldering terminals	Without positioning bosses	Header	With soldering terminals	Without positioning bosses
	Without soldering terminals	Without positioning bosses		Without soldering terminals	Without positioning bosses
		AXK7E**26G			AXK8E**26WG
		AXK7E**46G			AXK8E**46WG

- Notes: 1. When placing an order, substitute the "*" (asterisk) in the above part number with the number of pins for the specific connecto . 2. The above part numbers are for connectors without positioning bosses, which are standard. When ordering connectors with positioning bosses, please contact our local sales offic .

NOTES

1. As shown below, excess force during insertion may result in damage to the connector or removal of the solder. Also, to prevent connector damage please confirm the correct position before mating connectors.

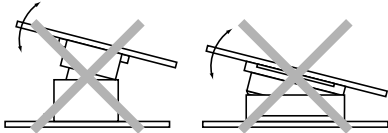

2. Keep the PC board warp no more than 0.03 mm in relation to the overall length of the connector.

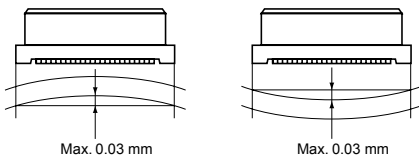

3. Recommended PC board and metal mask patterns

Connectors are mounted with high pitch density, intervals of 0.35 mm, 0.4 mm or 0.5 mm.

In order to reduce solder bridges and other issues make sure the proper levels of solder is used.

The figures to the right are recommended metal mask patterns. Please use them as a reference.

1) Without soldering terminals

Socket

Recommended PC board pattern (TOP VIEW)

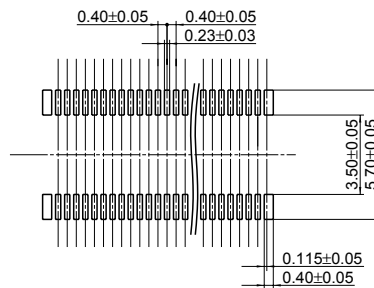

Recommended metal mask pattern

Metal mask thickness: Here, 150 μm
(Opening area ratio: 40%)

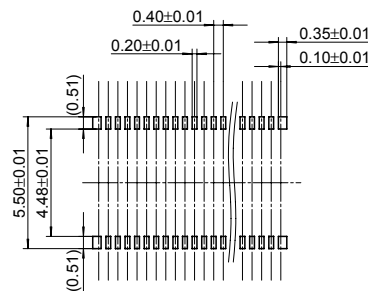

Recommended metal mask pattern

Metal mask thickness: Here, 120 μm
(Opening area ratio: 50%)

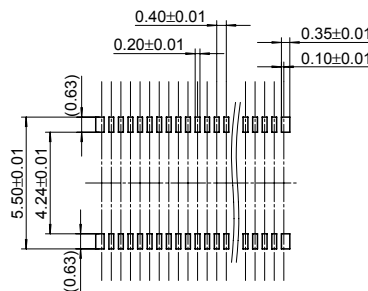

Header

Recommended PC board pattern (TOP VIEW)

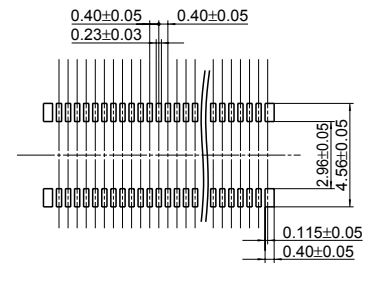

Recommended metal mask pattern

Metal mask thickness: Here, 150 μm
(Opening area ratio: 32%)

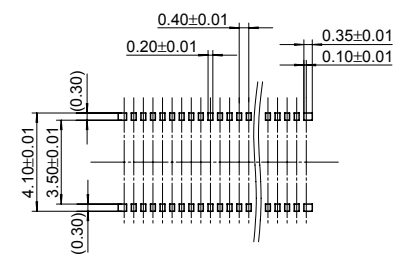

Recommended metal mask pattern

Metal mask thickness: Here, 120 μm
(Opening area ratio: 40%)

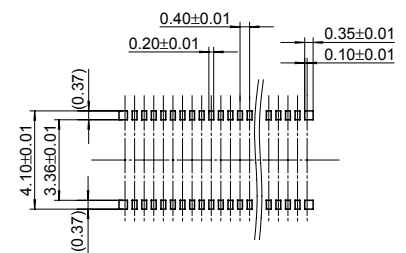

2) With soldering terminals

Socket

Recommended PC board pattern (TOP VIEW)

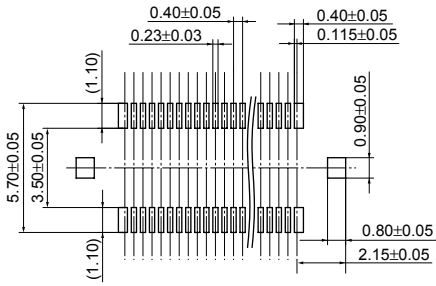

Recommended metal mask pattern

Metal mask thickness: Here, 150 μm
(Terminal portion opening area ratio: 40%)
(Metal portion opening area ratio: 65%)

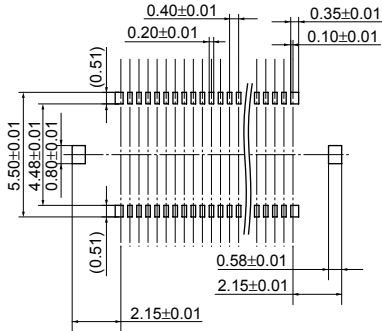

Recommended metal mask pattern

Metal mask thickness: Here, 120 μm
(Terminal portion opening area ratio: 50%)
(Metal portion opening area ratio: 80%)

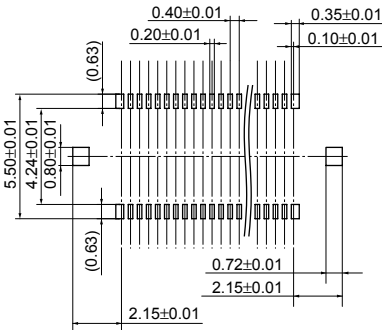

Header

Recommended PC board pattern (TOP VIEW)

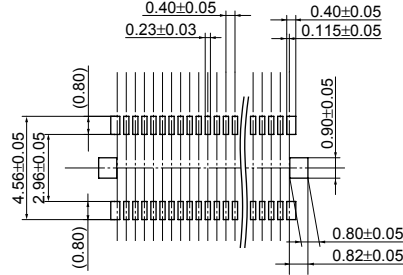

Recommended metal mask pattern

Metal mask thickness: Here, 150 μm
(Terminal portion opening area ratio: 32%)
(Metal portion opening area ratio: 65%)

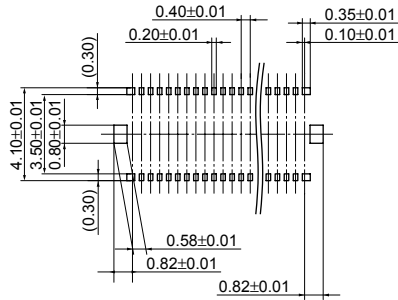

Recommended metal mask pattern

Metal mask thickness: Here, 120 μm
(Terminal portion opening area ratio: 40%)
(Metal portion opening area ratio: 80%)

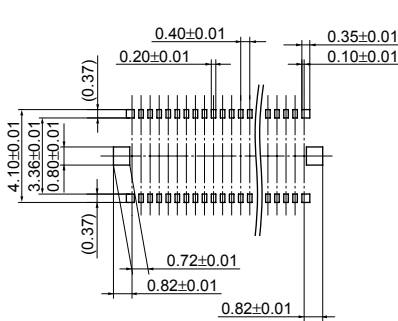

Please refer to the latest product specifications when designing our product.

Notes on Using Narrow pitch Connectors

Regarding the design of devices and PC board patterns

1) When connecting several connectors together by stacking, make sure to maintain proper accuracy in the design of structure and mounting equipment so that the connectors are not subjected to twisting and torsional forces.

2) With mounting equipment, there may be up to a ± 0.2 to 0.3 -mm error in positioning. Be sure to design PC boards and patterns while taking into consideration the performance and abilities of the required equipment.

3) Some connectors have tabs embossed on the body to aid in positioning. When using these connectors, make sure that the PC board is designed with positioning holes to match these tabs.

4) To ensure the required mechanical strength when soldering the connector terminals, make sure the PC board meets recommended PC board pattern design dimensions given.

5) For all connectors of the narrow pitch series, to prevent the PC board from coming off during vibrations or impacts, and to prevent loads from falling directly on the soldered portions, be sure to design some means to fix the PC board in place.

Example) Secure in place with screws

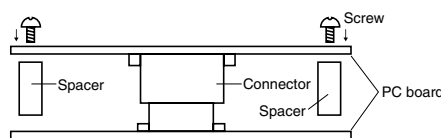

When connecting PC boards, take appropriate measures to prevent the connector from coming off.

6) Notes when using a FPC.

(1) When the connector is soldered to an FPC board, during its insertion and removal procedures, forces may be applied to the terminals and cause the soldering to come off. It is recommended to use a reinforcement board on the

backside of the FPC board to which the connector is being connected. Please make the reinforcement board dimensions bigger than the outer limits of the recommended PC board pattern (should be approximately 1 mm greater than the outer limit).

Material should be glass epoxy or polyimide, and the thickness should be between 0.2 and 0.3 mm.

(2) Collisions, impacts, or turning of FPC boards, may apply forces on the connector and cause it to come loose. Therefore, make to design retaining plates or screws that will fix the connector in place.

7) The narrow pitch connector series is designed to be compact and thin.

Although ease of handling has been taken into account, take care when mating the connectors, as displacement or angled mating could damage or deform the connector.

Regarding the selection of the connector placement machine and the mounting procedures

1) Select the placement machine taking into consideration the connector height, required positioning accuracy, and packaging conditions.

2) Be aware that if the catching force of the placement machine is too great, it may deform the shape of the connector body or connector terminals.

3) Be aware that during mounting, external forces may be applied to the connector contact surfaces and terminals and cause deformations.

4) Depending on the size of the connector being used, self alignment may not be possible. In such cases, be sure to carefully position the terminal with the PC board pattern.

5) The positioning bosses give an approximate alignment for positioning on the PC board. For accurate positioning of the connector when mounting it to the PC board, we recommend using an automatic positioning machine.

6) Excessive mouter chucking force may deform the molded or metal part of the connector. Consult us in advance if chucking is to be applied.

Regarding soldering

1. Reflow soldering

- 1) Measure the recommended profile temperature for reflow soldering by placing a sensor on the PC board near the connector surface or terminals. (The setting for the sensor will differ depending on the sensor used, so be sure to carefully read the instructions that comes with it.)
- 2) As for cream solder printing, screen printing is recommended.
- 3) To determine the relationship between the screen opening area and the PC-board foot pattern area, refer to the diagrams in the recommended patterns for PC boards and metal masks. Make sure to use the terminal tip as a reference position when setting. Avoid an excessive amount of solder from being applied, otherwise, interference by the solder will cause an imperfect contact.

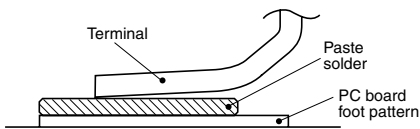

- 4) Consult us when using a screen-printing thickness other than that recommended.
- 5) When mounting on both sides of the PC board and the connector is mounting on the underside, use adhesives or other means to ensure the connector is properly fixed to the PC board. (Double reflow soldering on the same side is possible.)
- 6) N₂ reflow, conducting reflow soldering in a nitrogen atmosphere, increases the solder flow too greatly, enabling wicking to occur. Make sure that the solder feed rate and temperature profile are appropriate.

Soldering conditions

Please use the reflow temperature profile conditions recommended below for reflow soldering. Please contact us before using a temperature profile other than that described below (e.g. lead-free solder).

- Narrow pitch connectors (except P8 type)

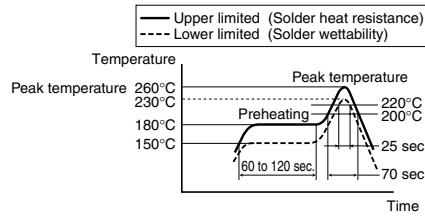

- Narrow pitch connector (P8)

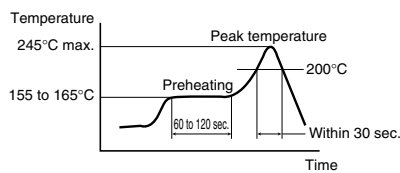

For products other than the ones above, please refer to the latest product specifications.

- 7) The temperatures are measured at the surface of the PC board near the connector terminals. (The setting for the sensor will differ depending on the sensor used, so be sure to carefully read the instructions that comes with it.)
- 8) The temperature profiles given in this catalog are values measured when using the connector on a resin-based PC board. When performed reflow soldering on a metal board (iron, aluminum, etc.) or a metal table to mount on a FPC, make sure there is no deformation or discoloration of the connector beforehand and then begin mounting.
- 9) Consult us when using a screen-printing thickness other than that recommended.
- 10) Some solder and flux types may cause serious solder or flux creeping. Solder and flux characteristics should be taken into consideration when setting the reflow soldering conditions.

2. Hand soldering

- 1) Set the soldering iron so that the tip temperature is less than that given in the table below.

Table A

Product name	Soldering iron temperature
SMD type connectors	300°C within 5 sec. 350°C within 3 sec.

- 2) Do not allow flux to spread onto the connector leads or PC board. This may lead to flux rising up to the connector inside.
- 3) Touch the soldering iron to the foot pattern. After the foot pattern and connector terminal are heated, apply the solder wire so it melts at the end of the connector terminals.

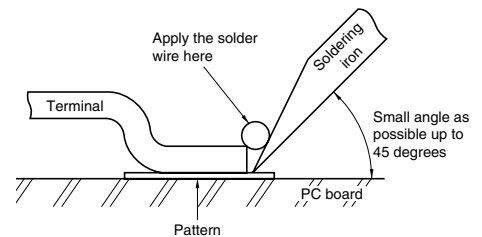

- 4) Be aware that soldering while applying a load on the connector terminals may cause improper operation of the connector.
 - 5) Thoroughly clean the soldering iron.
 - 6) Flux from the solder wire may get on the contact surfaces during soldering operations. After soldering, carefully check the contact surfaces and clean off any solder before use.
 - 7) For soldering of prototype devices during product development, you can perform soldering at the necessary locations by heating with a hot-air gun by applying cream solder to the foot pattern beforehand. However, at this time, make sure that the air pressure does not move connectors by carefully holding them down with tweezers or other similar tool. Also, be careful not to go too close to the connectors and melt any of the molded components.
 - 8) If an excessive amount of solder is applied during manual soldering, the solder may creep up near the contact points, or solder interference may cause imperfect contact.
- ### 3. Solder reworking
- 1) Finish reworking in one operation.
 - 2) For reworking of the solder bridge, use a soldering iron with a flat tip. To prevent flux from climbing up to the contact surfaces, do not add more flux.
 - 3) Keep the soldering iron tip temperature below the temperature given in Table A.

Handling Single Components

- 1) Make sure not to drop or allow parts to fall from work bench
- 2) Excessive force applied to the terminals could cause warping, come out, or weaken the adhesive strength of the solder. Handle with care.
- 3) Repeated bending of the terminals may cause terminals to break.

- 4) Do not insert or remove the connector when it is not soldered. Forcibly applied external pressure on the terminals can weaken the adherence of the terminals to the molded part or cause the terminals to lose their evenness.
- 5) Excessive prying-force applied to one end may cause product breakage and separation of the solder joints at the terminal.

Excessive force applied for insertion in a pivot action as shown may also cause product breakage. Align the header and socket positions before connecting them.

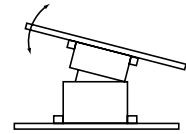

Cleaning flux from PC board

- 1) To increase the cleanliness of the cleaning fluid and cleaning operations, prepare equipment for cleaning process beginning with boil cleaning, ultrasonic cleaning, and then vapor cleaning.
- 2) Carefully oversee the cleanliness of the cleaning fluids to make sure that the contact surfaces do not become dirty from the cleaning fluid itself.

- 3) Since some powerful cleaning solutions may dissolve molded components of the connector and wipe off or discolor printed letters, we recommend aqua pura electronic parts cleaners. Please consult us if you wish to use other types of cleaning fluids.
- 4) Please note that the surfaces of molded parts may whiten when cleaned with alcohol.

Handling the PC board

- **Handling the PC board after mounting the connector**
- When cutting or bending the PC board after mounting the connector, be careful that the soldered sections are subjected to excessive force.

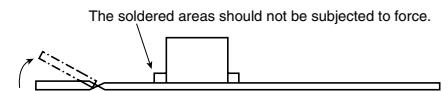

Storage of connectors

- 1) To prevent problems from voids or air pockets due to heat of reflow soldering, avoid storing the connectors in areas of high humidity. When storing the connectors for more than six months, be sure to consider storage area where the humidity is properly controlled.
- 2) Depending on the connector type, the color of the connector may vary from connector to connector depending on when it is produced.

- Some connectors may change color slightly if subjected to ultraviolet rays during storage. This is normal and will not affect the operation of the connector.
- 3) When storing the connectors with the PC boards assembled and components already set, be careful not to stack them up so the connectors are subjected to excessive forces.

- 4) Avoid storing the connectors in locations with excessive dust. The dust may accumulate and cause improper connections at the contact surfaces.

Other Notes

- 1) These products are made for the design of compact and lightweight devices and therefore the thickness of the molded components has been made very thin. Therefore, be careful during insertion and removal operations for excessive forces applied may damage the products.
- 2) Dropping of the products or rough mishandling may bend or damage the terminals and possibly hinder proper reflow soldering.

- 3) Before soldering, try not to insert or remove the connector more than absolutely necessary.
- 4) When coating the PC board after soldering the connector to prevent the deterioration of insulation, perform the coating in such a way so that the coating does not get on the connector.
- 5) There may be variations in the colors of products from different production lots. This is normal.

- 6) The connectors are not meant to be used for switching.
- 7) Be sure not to allow external pressure to act on connectors when assembling PCBs or moving in block assemblies.

Regarding sample orders to confirm proper mounting

When ordering samples to confirm proper mounting with the placement machine, connectors are delivered in 50-piece units in the condition given right. Consult a sale representative for ordering sample units.

Condition when delivered from manufacturing



Embossed tape amount required for the mounting

Required number of products for sample production (Unit 50 pcs.)

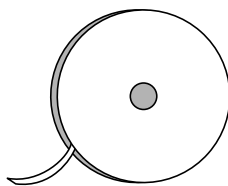



Reel

(Delivery can also be made on a reel by customer request.)

Please refer to the latest product specifications when designing your product.

Looking for pricing, stock, or lifecycle information?

Click below to explore more details on WIN SOURCE:

-  [View AXK816145WG on WIN SOURCE](#)
-  [Panasonic Information](#)

Optimize Your Supply Chain with WIN SOURCE Solutions

-  Global Sourcing Solution
-  Obsolete Management
-  Cost Control Management
-  Shortage Management
-  Alternative Solution
-  Excess Inventory Management