



**THE DATASHEET OF
TBPS1R333J460H5Q**



Notice for TAIYO YUDEN products

Please read this notice before using the TAIYO YUDEN products.



REMINDERS

- Product information in this catalog is as of October 2008. All of the contents specified herein are subject to change without notice due to technical improvements, etc. Therefore, please check for the latest information carefully before practical application or usage of the Products.

Please note that Taiyo Yuden Co., Ltd. shall not be responsible for any defects in products or equipment incorporating such products, which are caused under the conditions other than those specified in this catalog or individual specification.

- Please contact Taiyo Yuden Co., Ltd. for further details of product specifications as the individual specification is available.
- Please conduct validation and verification of products in actual condition of mounting and operating environment before commercial shipment of the equipment.
- All electronic components or functional modules listed in this catalog are developed, designed and intended for use in general electronics equipment.(for AV, office automation, household, office supply, information service, telecommunications, (such as mobile phone or PC) etc.). Before incorporating the components or devices into any equipment in the field such as transportation,(automotive control, train control, ship control), transportation signal, disaster prevention, medical, public information network (telephone exchange, base station) etc. which may have direct influence to harm or injure a human body, please contact Taiyo Yuden Co., Ltd. for more detail in advance.

Do not incorporate the products into any equipment in fields such as aerospace, aviation, nuclear control, submarine system, military, etc. where higher safety and reliability are especially required.

In addition, even electronic components or functional modules that are used for the general electronic equipment, if the equipment or the electric circuit require high safety or reliability function or performances, a sufficient reliability evaluation check for safety shall be performed before commercial shipment and moreover, due consideration to install a protective circuit is strongly recommended at customer's design stage.

- The contents of this catalog are applicable to the products which are purchased from our sales offices or distributors (so called "TAIYO YUDEN' s official sales channel").
It is only applicable to the products purchased from any of TAIYO YUDEN' s official sales channel.
- Please note that Taiyo Yuden Co., Ltd. shall have no responsibility for any controversies or disputes that may occur in connection with a third party's intellectual property rights and other related rights arising from your usage of products in this catalog. Taiyo Yuden Co., Ltd. grants no license for such rights.
- Caution for export
Certain items in this catalog may require specific procedures for export according to "Foreign Exchange and Foreign Trade Control Law" of Japan, "U.S. Export Administration Regulations," and other applicable regulations. Should you have any question or inquiry on this matter, please contact our sales staff.
Should you have any question or inquiry on this matter, please contact our sales staff.

積層チップNTCサーミスタ

MULTILAYER CHIP NTC THERMISTORS



OPERATING TEMP. -55~+125°C

フロー/WAVE* リフロー/REFLOW

* 1005TYPEを除く
* Except for 1005TYPE

特長 FEATURES

- ・125°C保証
- ・B定数が大きく温度検知能力が優れている
- ・表裏の区別がなくバルク、テーピングでの自動装着が可能
- ・寸法はEIAJ規格に準拠
- ・内部電極構造を採用することにより、信頼性向上を実現しています
- ・ Guaranteed up to 125°C.
- ・ Large B constant for higher temperature sensing capability.
- ・ Ideal for automatic mounting in bulk or from tapes because of front-rear symmetry.
- ・ Available in a standard EIA compatible case size.
- ・ Improved reliability due to use of internal electrodes.

用途 APPLICATIONS

- ・通信機用
自動車電話、携帯電話、コードレス電話ほか
- ・OA機器用
プリンタ、ファクシミリ、ワードプロセッサほか
- ・民生機器用
ビデオ、カラーテレビ、液晶テレビ、CDプレーヤほか
- ・バッテリー保護回路用
- ・ Telecommunications equipment : mobile telephones, cellular telephones, cordless telephones, etc.
- ・ Office automation : printers, facsimiles, word processors, etc.
- ・ Consumer electronics : VCRs, color television sets, LCD television sets, CD players, etc.
- ・ Battery protection circuit

形名表記法 ORDERING CODE

1 形式 TB NTCサーミスタ	3 寸法 [mm] S0 1.0×0.5 (0402) S1 1.6×0.8 (0603)	5 公称零負荷抵抗 [Ω] 例 102 1000 154 150000	7 公称B定数 [K] 例 295 記号×10 410 2950 410 4100	9 最低温度 [°C] 5 -55
2 形状 P メッキ電極品	4 包装 R 紙テーピング S 単品 (袋づめ)	6 抵抗許容差 [%] F ±1 G ±2 H ±3 J ±5 K ±10	8 B定数許容差 [%] F ±1 H ±3	10 最高温度 [°C] Q 125
				11 当社管理記号 △ 標準品 △=スペース

T B P S 1 S 1 0 3 K 4 4 0 H 5 Q ○

1 2 3 4 5 6 7 8 9 10 11

1 Type TB NTC THERMISTOR	3 Dimension [mm] S0 1.0×0.5 (0402) S1 1.6×0.8 (0603)	5 Nominal Zero-Power Resistance [Ω] example 102 1000 154 150000	7 Nominal B constant [K] example Symbol×10 295 2950 410 4100	9 Min. temperature [°C] 5 -55
2 Shape P Plated terminal	4 Packaging R Tape&Reel S Bulk	6 Resistance tolerance [%] F ±1 G ±2 H ±3 J ±5 K ±10	8 B constant tolerance [%] F ±1 H ±3	10 Max. temperature [°C] Q 125
				11 Internal code △ Standard product △=Blank space

外形寸法 EXTERNAL DIMENSIONS

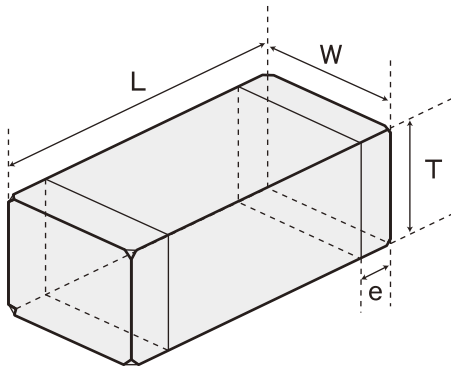

Type	L	W	T	e
1005 (0402)	1.0±0.05 (0.039±0.002)	0.5±0.05 (0.020±0.002)	0.5±0.05 (0.020±0.002)	0.25±0.10 (0.010±0.004)
1608 (0603)	1.6±0.15 (0.063±0.006)	0.8±0.15 (0.031±0.006)	0.8±0.15 (0.031±0.006)	0.35±0.25 (0.014±0.010)

Unit : mm (Inch)

R-T特性図 R-T CHARACTERISTICS

1005type (0402)

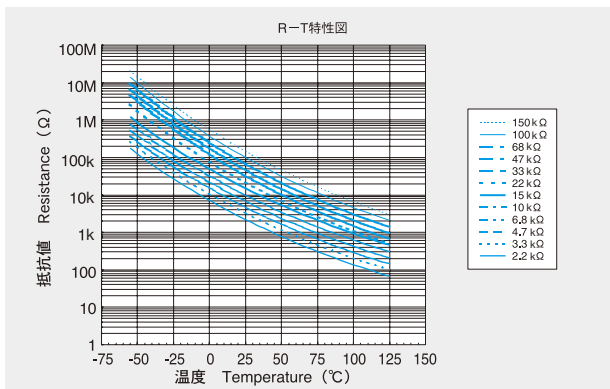

1608type (0603)

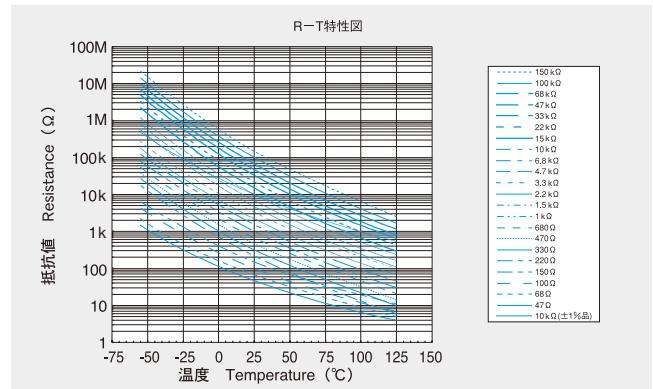

仕様 SPECIFICATIONS

	許容差 (記号) Tolerance (Symbols)
R25	±1% (F), ±2% (G), ±3% (H), ±5% (J), ±10% (K)
B定数 B Constant	±1% (F), ±3% (H)

セレクトションガイド
Selection Guide



etc

アイテム一覧
Part Numbers



特性図
Electrical Characteristics



梱包
Packaging

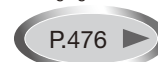

信頼性
Reliability Data



使用上の注意
Precautions



※営業窓口にご相談ください。Please contact our Sales Department.

1005TYPE

形名 Ordering Code	EHS (Environmental Hazardous Substances)	R25 [kΩ]	B定数 B constant		熱時定数 Thermal time constant	熱放散定数 Dissipation factor	定格電力 Rated Power	備考 Remark
			(K : 25/85°C)	(K : 25/50°C)				
TBPS0○222△410H5Q	RoHS	2.2	4100	4034	≦3 sec	0.5~2.0 mW/°C	35mW	
TBPS0○332△410H5Q	RoHS	3.3	4100	4034				
TBPS0○472△410H5Q	RoHS	4.7	4100	4034				
TBPS0○682△410H5Q	RoHS	6.8	4100	4034				
TBPS0○103△410H5Q	RoHS	10	4100	4034				
TBPS0○153△410H5Q	RoHS	15	4100	4034				
TBPS0○223△440H5Q	RoHS	22	4400	4336				
TBPS0○333△455H5Q	RoHS	33	4550	4483				
TBPS0○473△455H5Q	RoHS	47	4550	4483				
TBPS0○683△455H5Q	RoHS	68	4550	4483				
TBPS0○104△455H5Q	RoHS	100	4550	4483				
TBPS0○154△455H5Q	RoHS	150	4550	4483				

形名の○には包装 (R=テーピング、S=単品)、△には抵抗許容差記号 (J,K) が入ります。
 ○Please specify the packaging code (R : tape & reel, S : Bulk) and △ the resistance tolerance code (J, K).

1608TYPE

形名 Ordering Code	EHS (Environmental Hazardous Substances)	R25 [kΩ]	B定数 B constant		熱時定数 Thermal time constant	熱放散定数 Dissipation factor	定格電力 Rated Power	備考 Remark
			(K : 25/85°C)	(K : 25/50°C)				
TBPS1○470△295H5Q	RoHS	0.047	2950	2934	≦5 sec	1.0~2.5 mW/°C	63mW	
TBPS1○680△295H5Q	RoHS	0.068	2950	2934				
TBPS1○101△315H5Q	RoHS	0.100	3150	3157				
TBPS1○151△315H5Q	RoHS	0.150	3150	3157				
TBPS1○221△410H5Q	RoHS	0.22	4100	4034				
TBPS1○331△410H5Q	RoHS	0.33	4100	4034				
TBPS1○471△410H5Q	RoHS	0.47	4100	4034				
TBPS1○681△410H5Q	RoHS	0.68	4100	4034				
TBPS1○102△410H5Q	RoHS	1.0	4100	4034				
TBPS1○152△410H5Q	RoHS	1.5	4100	4034				
TBPS1○222△410H5Q	RoHS	2.2	4100	4034				
TBPS1○332△410H5Q	RoHS	3.3	4100	4034				
TBPS1○472△440H5Q	RoHS	4.7	4400	4336				
TBPS1○682△440H5Q	RoHS	6.8	4400	4336				
TBPS1○103△440H5Q	RoHS	10	4400	4336				
TBPS1○153△460H5Q	RoHS	15	4600	4533				
TBPS1○223△460H5Q	RoHS	22	4600	4533				
TBPS1○333△460H5Q	RoHS	33	4600	4533				
TBPS1○473△475H5Q	RoHS	47	4750	4642				
TBPS1○683△475H5Q	RoHS	68	4750	4642				
TBPS1○104△475H5Q	RoHS	100	4750	4642				
TBPS1○154△475H5Q	RoHS	150	4750	4642				
TBPS1○103△344F5Q	RoHS	10	3435	3395				

形名の○には包装 (R=テーピング、S=単品)、△には抵抗値許容差記号 (J, K (TBP S1 ○ 103 △ 344 F 5QはF,GまたはH)) が入ります。
 ○Please specify the packaging code (R : tape & reel, S : Bulk) and △ the resistance tolerance code (F,G or H for TBP S1 ○ 103 △ 344 F 5Q J, K for other part numbers).

1005type (0402)

高温放置 High Temperature Life Test
試験条件 Test Condition 125°C

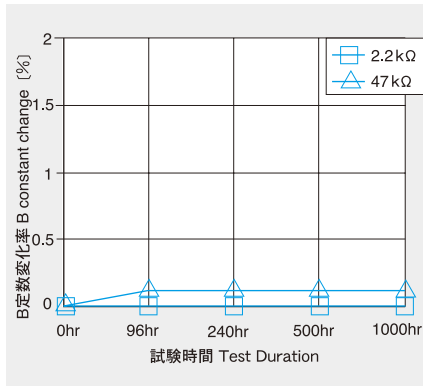
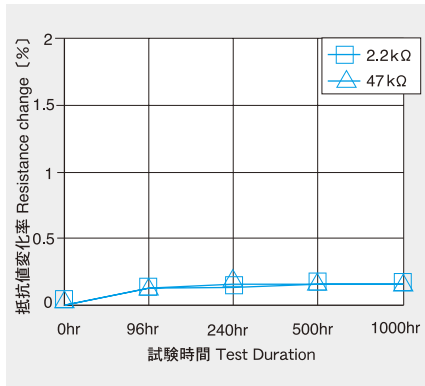

耐湿性 Damp Heat (steady state)

試験条件 Test Condition 85°C95%

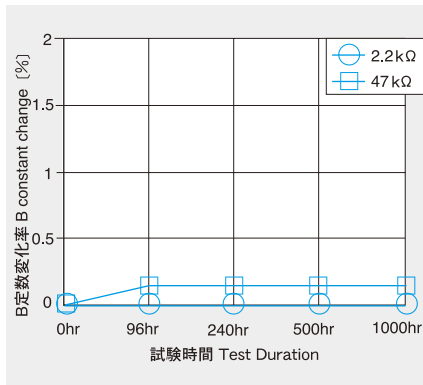
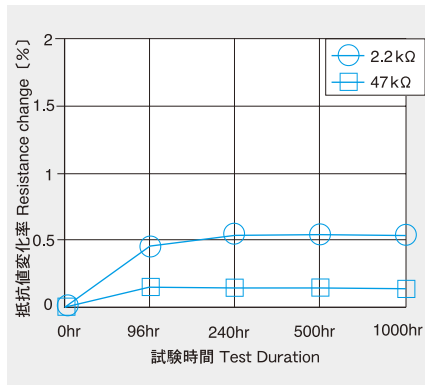

1608type (0603)

高温放置 High Temperature Life Test
試験条件 Test Condition 125°C

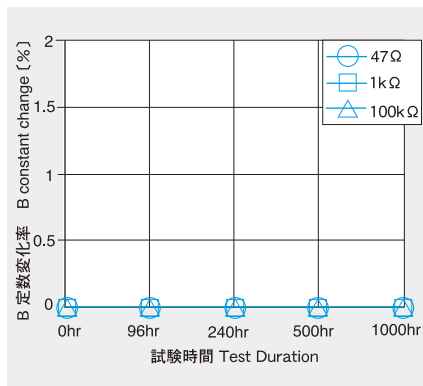
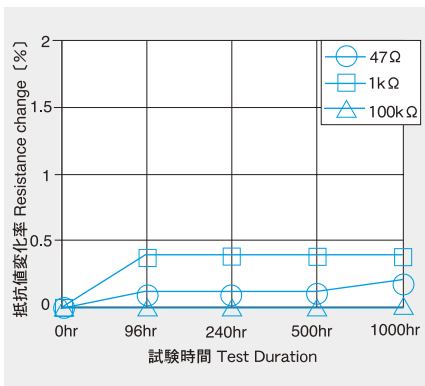

耐湿性 Damp Heat (steady state)

試験条件 Test Condition 85°C95%

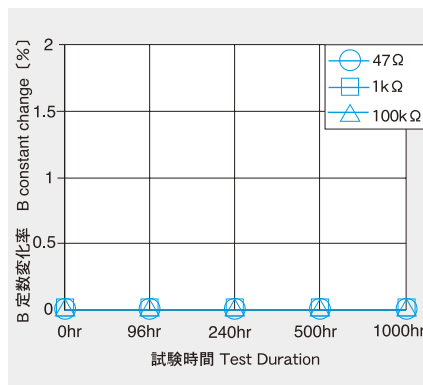
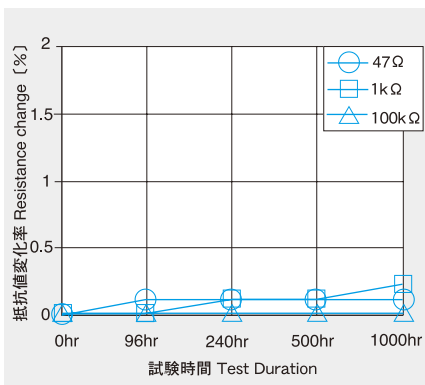

MULTILAYER CHIP NTC THERMISTORS

Item	Specified Value		Test Methods and Remarks
	1005 (0402)	1608 (0603)	
1. Operating Temperature Range	-55 to +125°C		
2. Storage Temperature Range	-55 to +125°C		
3. Rated Power	35mW	63mW	
4. Nominal Zero-Power Resistance	2.2~150kΩ ±5% ±10%	0.047~150kΩ ±5% ±10%	Ambient temperature : 25±0.2°C Measuring electric power : 0.1mW max.
5. Nominal B Constant	4100~4550K ±3%	2950~4750K ±3%	Measure the resistance at the ambient temperatures of 25±0.2°C and +85±0.2°C. $B = \frac{\ln R_{25} - \ln R_{85}}{1/T_{25} - 1/T_{85}}$ T : Absolute temperature T0 : 273.15
6. Dissipation Constant (single unit)	0.5 to 2.0mW/°C	1.0 to 2.5mW/°C	This represents the amount of electric power required to raise the temperature of the element by 1°C through self-heating under thermal equilibrium.
7. Thermal Time Constant (single unit)	Within 3 sec.	Within 5 sec.	This represents the amount of time for the temperature of the thermistor element to change by 63.2% of the difference between the initial temperature and the ambient temperature by the drastic change of power application into thermistor from non-zero-power to zero-power state.
8. Rated Ambient Temperature	25°C		This represents the maximum ambient temperature at which rated power could be applied.
9. Electric Power Derating Curve	As shown in the figure at right.		This represents the relations between the ambient temperature and the maximum permissible power. Rated electric power ratio [%] Ambient temperature [°C] Max. Temperature
10. Resistance to Flexure of Substrate	R25 change : Within ±3% B constant change : Within ±1%	R25 change : Within ±5% B constant change : Within ±2%	Warp : 2mm Testing board : glass-epoxy-resin substrate Board thickness : 0.8mm Pressing speed : 0.5mm/sec. Duration : 30 sec.
11. Adhesion of Terminal Electrode	R25 change : Within ±3% B constant change : Within ±1%	R25 change : Within ±5% B constant change : Within ±2%	Applied force : 5N Duration : 10sec.

MULTILAYER CHIP NTC THERMISTORS

Item	Specified Value		Test Methods and Remarks
	1005 (0402)	1608 (0603)	
12. Solderability	At least 75% of terminal electrode is covered by new solder.	At least 80% of terminal electrode is covered by new solder.	According to JIS C5102 clause 8.4. Solder temperature : 230±5°C Duration : 4±1 sec.
13. Resistance to Soldering	R25 change : Within ±3% B constant change : Within ±1%	R25 change : Within ±5% B constant change : Within ±2%	Reflow soldering : Solder temperature : 240°C Duration : 5 sec. Preheating temperature : 150°C Preheating time : 90 sec. Number of reflows : 3 times testing substrate : glass-epoxy-resin substrate
14. Thermal Shock	R25 change : Within ±3% B Constant change : Within ±1%	R25 change : Within ±5% B Constant change : Within ±3%	Conditions for 1 cycle Step1 : Minimum operating temperature +0/-3°C 30±3 min Step2 : Room temperature 2 to 3 min Step3 : Maximum operating temperature +0/-3°C 30±3 min Step4 : Room temperature 2 to 3 min Number of cycles : 5 Recovery : 2 to 3 hrs of recovery under the standard condition after the test.
15. High Temperature Life Test	R25 change : Within ±3% B Constant change : Within ±1%	R25 change : Within ±5% B Constant change : Within ±3%	Temperature : 125±2°C Duration : 1000±12 hrs Recovery : 2 hrs of recovery under the standard condition after the removal from test chamber. testing substrate : glass-epoxy-resin substrate
16. Damp Heat (steady state)	R25 change : Within ±3% B Constant change : Within ±1%	R25 change : Within ±5% B Constant change : Within ±3%	Temperature : 85±2°C Humidity : 85±5%RH Duration : 1000±12 hrs Recovery : 2 hrs of recovery under the standard condition after the removal from test chamber. testing substrate : glass-epoxy-resin substrate

Note on standard condition : "standard condition" referred to herein is defined as follows :
5 to 35°C of temperature, 45 to 85% relative humidity and 86 to 106kPa of air pressure.

When there are questions concerning measurement results :

In order to provide correlation data, the test shall be conducted under condition of 20±2°C of temperature, 60 to 70% relative humidity and 86 to 106kPa of air pressure.

Unless otherwise specified, all the tests are conducted under the "standard condition."

Looking for pricing, stock, or lifecycle information?

Click below to explore more details on WIN SOURCE:

- ⊖ [View TBPS1R333J460H5Q on WIN SOURCE](#)
- ⊖ [Taiyo Yuden Information](#)

Optimize Your Supply Chain with WIN SOURCE Solutions

- ✓ Global Sourcing Solution
- ✓ Obsolete Management
- ✓ Cost Control Management
- ✓ Shortage Management
- ✓ Alternative Solution
- ✓ Excess Inventory Management