



# THE DATASHEET OF SM4T47AY





### Complies with the following standards

- ISO 10605, C = 150 pF, R = 330 Ω:
  - 30 kV (air discharge)
  - 30 kV (contact discharge)
- ISO 10605, C = 330 pF, R = 330 Ω:
  - 30 kV (air discharge)
  - 30 kV (contact discharge)
- ISO 7637-2<sup>(a)</sup>
  - pulse 1:  $V_S = -100$  V
  - pulse 2a:  $V_S = +50$  V
  - pulse 3a:  $V_S = -150$  V
  - pulse 3b:  $V_S = +100$  V

### Features

- Peak pulse power:
  - 400 W (10/1000 μs)
  - 2.3 kW (8/20 μs)
- Stand-off voltage range: from 5 V to 70 V
- Unidirectional and bidirectional types
- Low leakage current:
  - 0.2 μA at 25 °C
  - 1 μA at 85 °C
- Operating  $T_{j\max}$ : 150 °C
- High power capability at  $T_{j\max}$ :
  - 270 W (10/1000 μs)
- JEDEC registered package outline
- Resin meets UL 94, V0
- AEC-Q101 qualified

### Description

The SM4TY Transil series has been designed to protect sensitive automotive circuits against surges defined in ISO 7637-2 and against electrostatic discharges according to ISO 10605.

The planar technology makes it compatible with high-end circuits where low leakage current and high junction temperature are required to provide reliability and stability over time. SM4TY devices are packaged in SMA (SMA footprint in accordance with IPC 7531 standard).

**TM:** Transil is a trademark of STMicroelectronics

a. Not applicable to parts with stand-off voltage lower than the average battery voltage (13.5 V)

# 1 Characteristics

Table 1. Absolute maximum ratings ( $T_{amb} = 25\text{ }^{\circ}\text{C}$ )

Symbol	Parameter		Value	Unit
$V_{PP}$	Peak pulse voltage	ISO 10605 (C = 150 pF, R = 330 $\Omega$ )		kV
		Contact discharge	30	
		Air discharge	30	
		ISO 10605, C = 330 pF, R = 330 $\Omega$ :		
		Contact discharge	30	
		Air discharge	30	
PPP	Peak pulse power dissipation <sup>(1)</sup>	$T_{j\text{ initial}} = T_{amb}$	400	W
$T_{stg}$	Storage temperature range		-65 to + 150	$^{\circ}\text{C}$
$T_j$	Operating junction temperature range		-55 to + 150	$^{\circ}\text{C}$
$T_L$	Maximum lead temperature for soldering during 10 s.		260	$^{\circ}\text{C}$

1. For a surge greater than the maximum values, the diode will fail in short-circuit.

Figure 1. Electrical characteristics - definitions



Figure 2. Pulse definition for electrical characteristics



Table 2. Electrical characteristics, typical values if not otherwise stated ( $T_{amb} = 25\text{ °C}$ )

Order code	$I_{RM} \text{ max @ } V_{RM}$		$V_{BR} \text{ @ } I_R^{(1)}$				$V_{CL} \text{ @ } I_{PP} \text{ 10/1000 } \mu\text{s}$		$R_D \text{ 10/1000 } \mu\text{s}$	$V_{CL} \text{ @ } I_{PP} \text{ 8/20 } \mu\text{s}$		$R_D \text{ 8/20 } \mu\text{s}$	$\alpha T^{(2)}$	
	25 °C	85 °C	min.	typ.	max.	max.			max.			max		
	$\mu\text{A}$	V	V			mA	V <sup>(3)</sup>	A <sup>(4)</sup>	$\Omega$	V <sup>(3)</sup>	A <sup>(4)</sup>	$\Omega$	10-4/ °C	
SM4T6V7AY/CAY	20	50	5	6.4	6.74	7.1	10	9.2	43.5	0.049	13.4	174	0.036	5.7
SM4T7V6AY/CAY	20	50	6.5	7.2	7.58	8.0	10	11.2	35.7	0.091	14.5	160	0.041	6.1
SM4T10AY/CAY	20	50	8.5	9.4	9.9	10.4	1	14.4	27.7	0.145	19.5	124	0.073	7.3
SM4T12AY/CAY	0.2	1	10	11.1	11.7	12.3	1	17.0	23.5	0.201	21.7	106	0.089	7.8
SM4T14AY/CAY	0.2	1	12	13.3	14.0	14.7	1	19.9	20.1	0.259	25.3	91	0.116	8.3
SM4T15AY/CAY	0.2	1	13	14.4	15.2	16.0	1	21.5	18.6	0.298	27.2	85	0.132	8.4
SM4T18AY/CAY	0.2	1	15	16.7	17.6	18.5	1	24.4	16.4	0.361	32.5	71	0.197	8.8
SM4T21AY/CAY	0.2	1	18	20.0	21.1	22.2	1	29.2	13.7	0.514	39.3	59	0.291	9.2
SM4T23AY/CAY	0.2	1	20	22.2	23.4	24.6	1	32.4	12.3	0.637	42.8	54	0.338	9.4
SM4T26AY/CAY	0.2	1	22	24.4	25.7	27.0	1	35.5	11.2	0.760	48.3	48	0.444	9.6
SM4T28AY/CAY	0.2	1	24	26.7	28.1	29.5	1	38.9	10.3	0.912	50	46	0.446	9.6
SM4T30AY/CAY	0.2	1	26	28.9	30.4	31.9	1	42.1	9.5	1.07	53.5	43	0.502	9.7
SM4T33AY/CAY	0.2	1	28	31.1	32.7	34.3	1	45.4	8.8	1.26	59	39	0.632	9.8
SM4T35AY/CAY	0.2	1	30	33.3	35.1	36.9	1	48.4	8.3	1.39	64.3	36	0.762	9.9
SM4T39AY/CAY	0.2	1	33	36.7	38.6	40.5	1	53.3	7.5	1.70	69.7	33	0.884	10
SM4T47AY/CAY	0.2	1	40	44.4	46.7	49.0	1	64.5	6.2	2.49	84	27	1.30	10.1
SM4T50AY/CAY	0.2	1	43	47.8	50.3	52.8	1	69.4	5.7	2.91	91	25	1.53	10.2
SM4T56AY/CAY	0.2	1	48	53.3	56.1	58.9	1	77.4	5.2	3.56	100	23	1.79	10.3
SM4T68AY/CAY	0.2	1	58	64.4	67.8	71.2	1	93.6	4.3	5.21	121	19	2.62	10.4
SM4T82AY/CAY	0.2	1	70	77.8	81.9	86.0	1	113	3.5	7.72	146	16	3.75	10.5

1. Pulse test:  $t_p < 50 \text{ ms}$

2. To calculate maximum clamping voltage at other surge level, use the following formula:  $V_{CL \text{ max}} = V_{CL} - R_D \times (I_{PP} - I_{PPappli})$   
where  $I_{PPappli}$  is the surge current in the application

3. To calculate  $V_{BR}$  or  $V_{CL}$  versus junction temperature, use the following formulas:

$$V_{BR} \text{ @ } T_J = V_{BR} \text{ @ } 25\text{ °C} \times (1 + \alpha T \times (T_J - 25))$$

$$V_{CL} \text{ @ } T_J = V_{CL} \text{ @ } 25\text{ °C} \times (1 + \alpha T \times (T_J - 25))$$

4. Surge capability given for both directions for unidirectional and bidirectional types.

Figure 3. Peak pulse power dissipation versus initial junction temperature

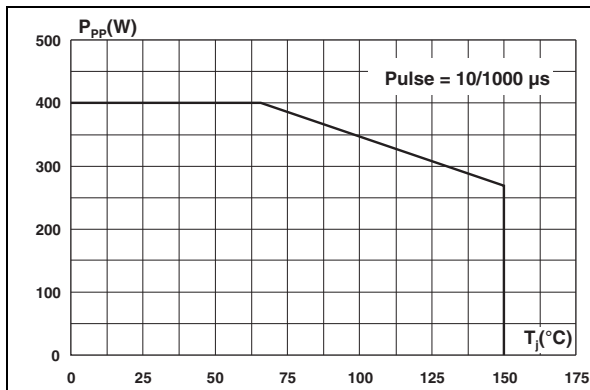

Figure 4. Peak pulse power versus exponential pulse duration ( $T_j$  initial = 25 °C)

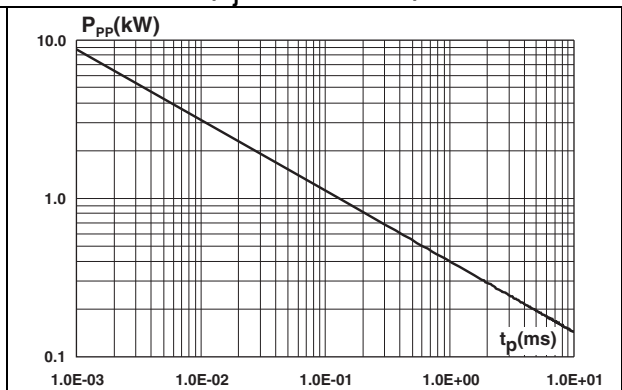

Figure 5. Clamping voltage versus peak pulse current (exponential waveform, maximum values)

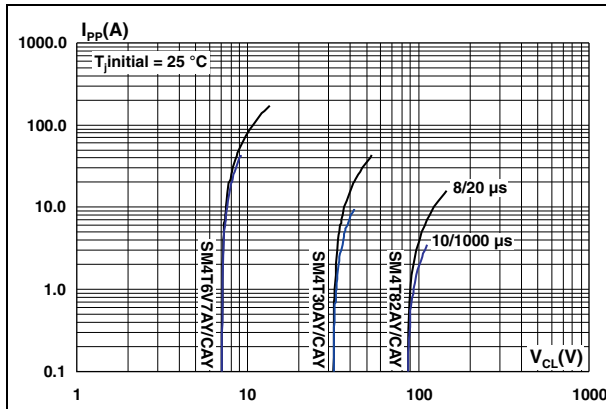

Figure 6. Junction capacitance versus reverse applied voltage for unidirectional types (typical values)

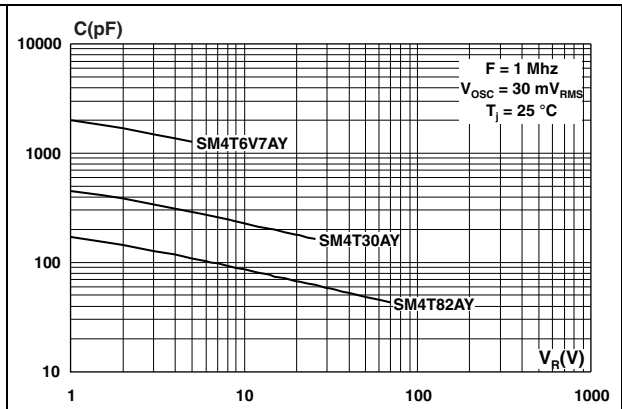

Figure 7. Junction capacitance versus reverse applied voltage for bidirectional types (typical values)

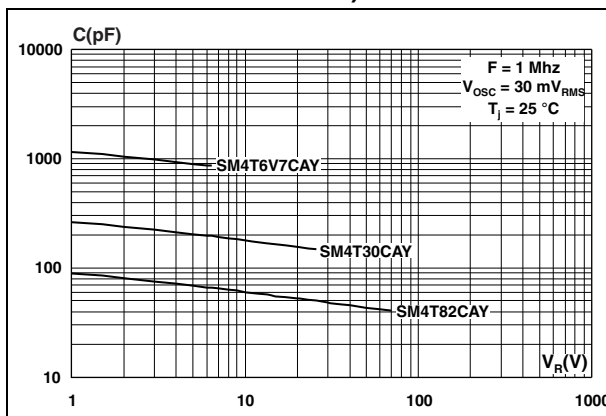

Figure 8. Relative variation of thermal impedance, junction to ambient, versus pulse duration

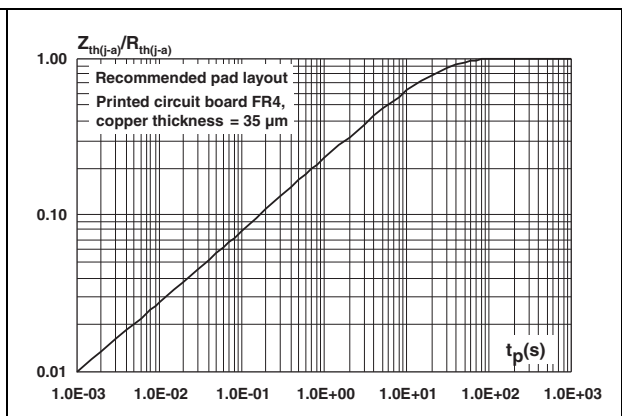

Figure 9. Thermal resistance junction to ambient versus copper surface under each lead

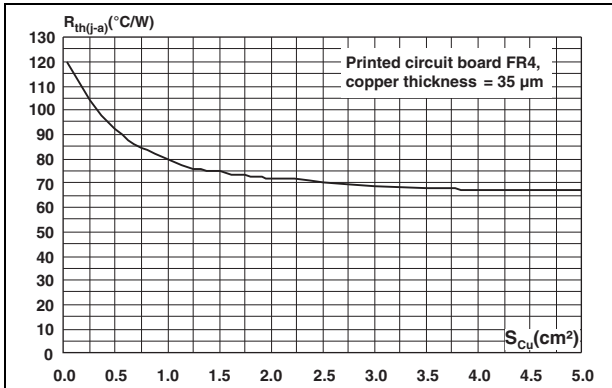

Figure 10. Leakage current versus junction temperature (typical values)

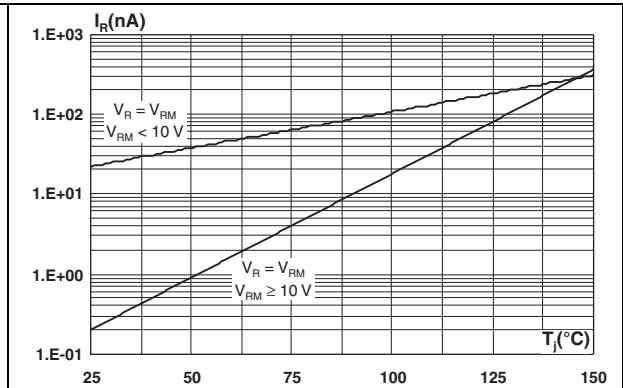

Figure 11. Peak forward voltage drop versus peak forward current (typical values)

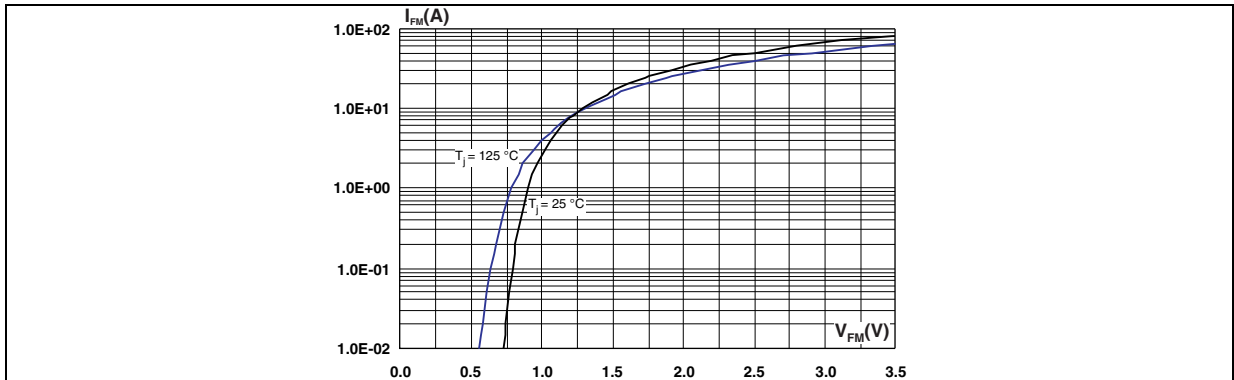

Figure 12. ISO7637-2 pulse 1 response ( $V_S = -100\text{ V}$ )

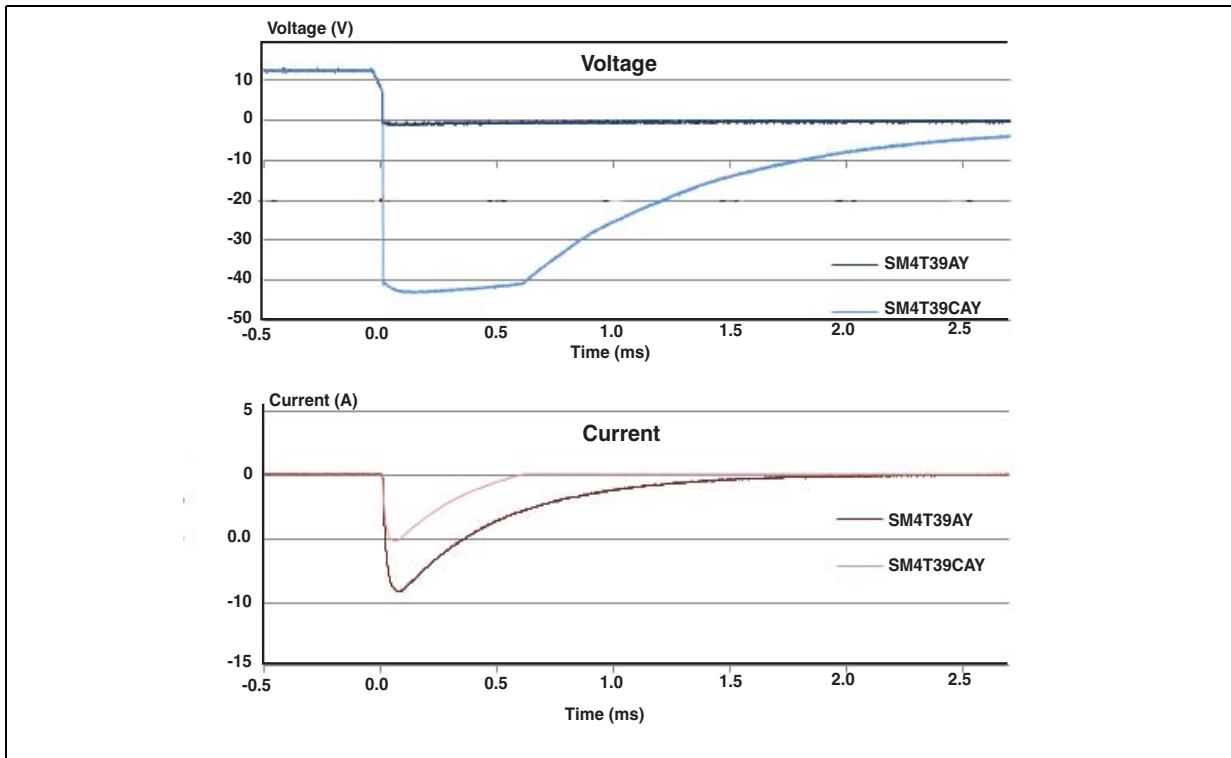

Figure 13. ISO7637-2 pulse 2a response ( $V_S = 50\text{ V}$ )

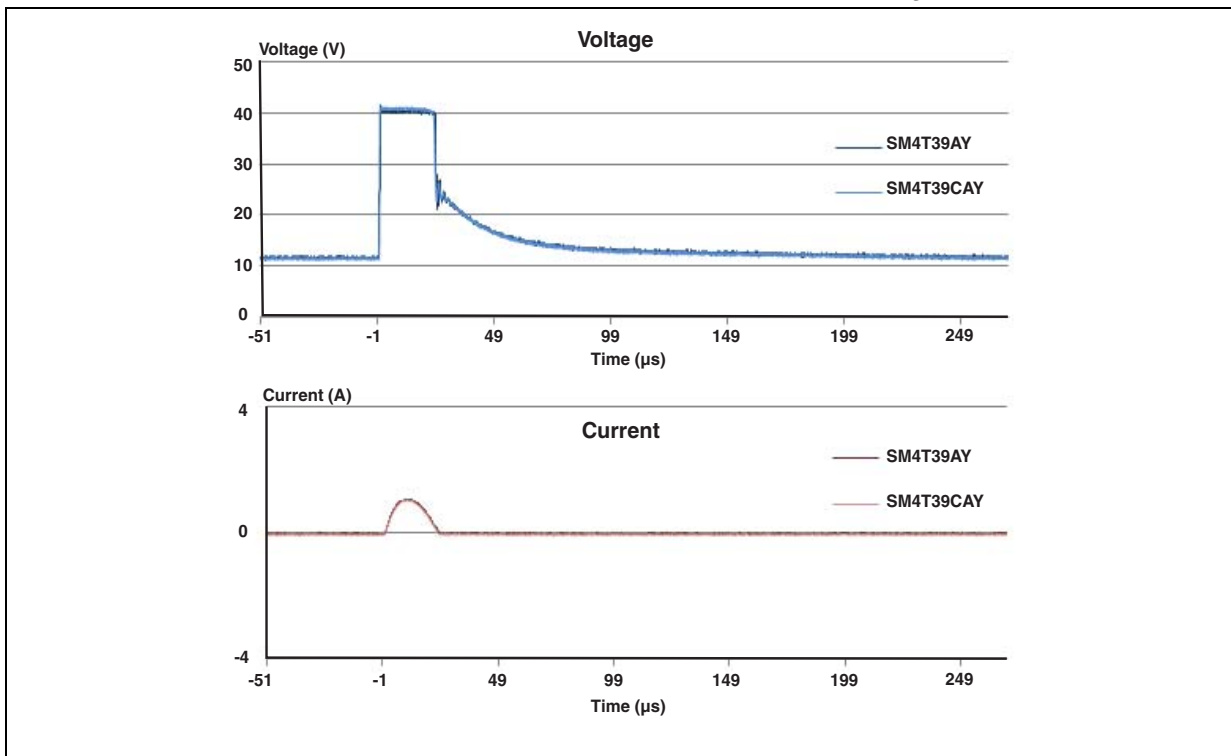

Figure 14. ISO7637-2 pulse 3a response ( $V_S = -150\text{ V}$ )

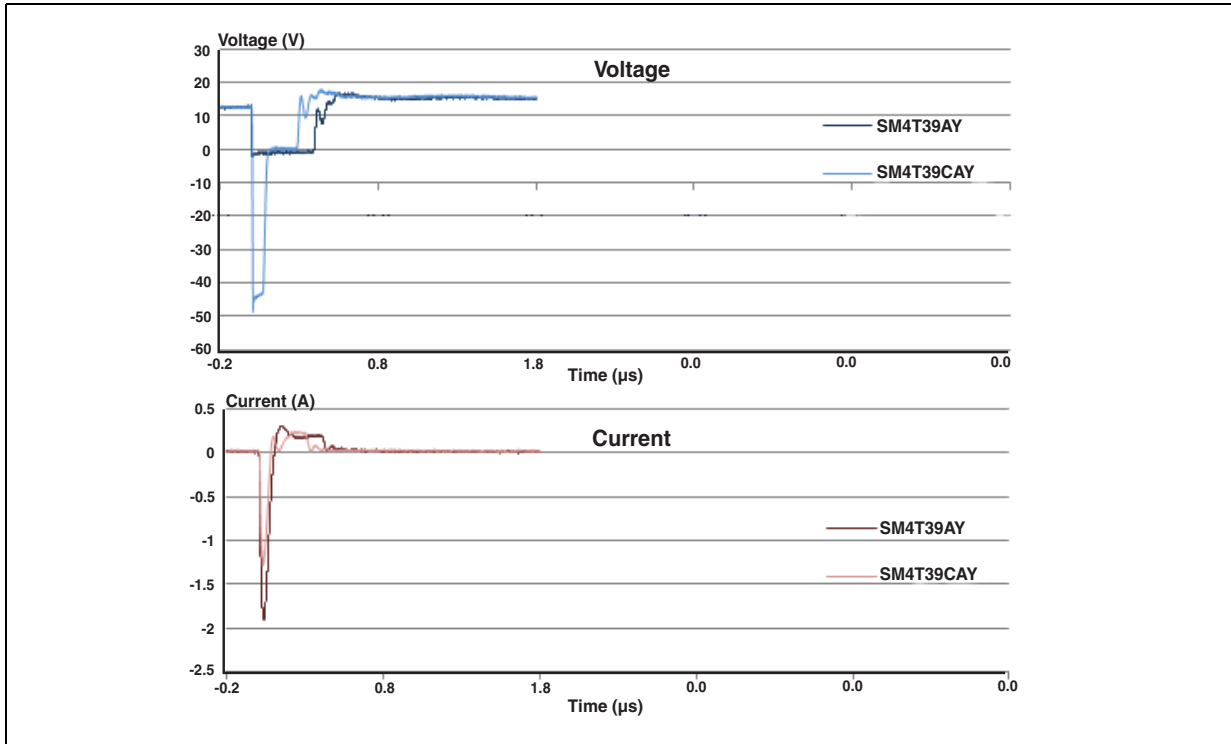
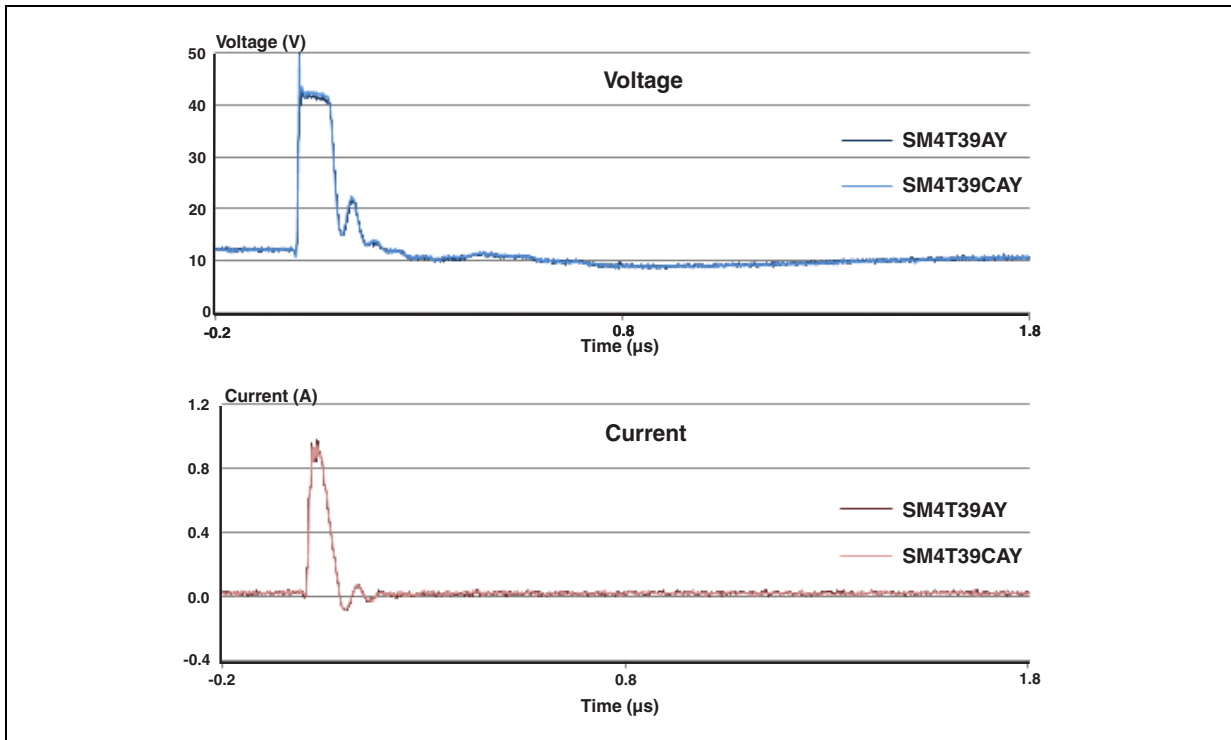

Figure 15. ISO7637-2 pulse 3b response ( $V_S = 100\text{ V}$ )



Note: ISO7637-2 pulses responses are not applicable for product with a stand off voltage lower than the average battery voltage (13.5 V).

## 2 Application and design guidelines

More information is available in the Application note AN2689 "Protection of automotive electronics from electrical hazards, guidelines for design and component selection".

## 3 Ordering information scheme

Figure 16. Ordering information scheme

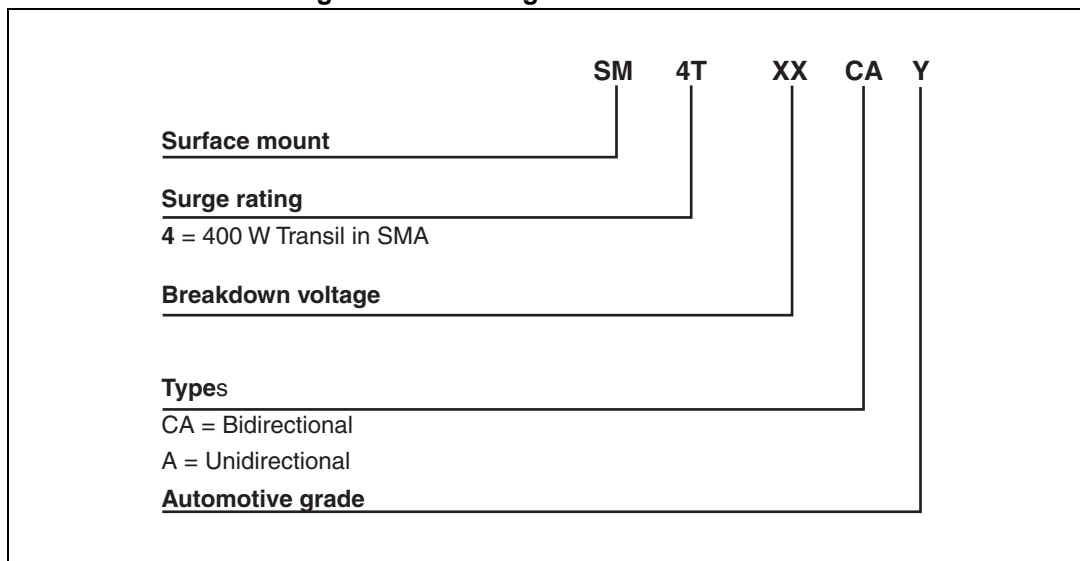

## 4 Package information

- Case: JEDEC DO-214AB molded plastic over planar junction
- Terminals: solder plated, solderable as per MIL-STD-750, Method 2026
- Polarity: for unidirectional types the band indicates cathode
- Flammability: epoxy is rated UL 94, V0
- RoHS package

In order to meet environmental requirements, ST offers these devices in different grades of ECOPACK® packages, depending on their level of environmental compliance. ECOPACK® specifications, grade definitions and product status are available at: [www.st.com](http://www.st.com). ECOPACK® is an ST trademark.

**Table 3. SMA package dimensions**

Ref.	Dimensions			
	Millimeters		Inches	
	Min.	Max.	Min.	Max.
A1	1.90	2.45	0.075	0.094
A2	0.05	0.20	0.002	0.008
b	1.25	1.65	0.049	0.065
c	0.15	0.40	0.006	0.016
D	2.25	2.90	0.089	0.114
E	4.80	5.35	0.189	0.211
E1	3.95	4.60	0.156	0.181
L	0.75	1.50	0.030	0.059

**Figure 17. SMA footprint dimensions in mm (inches)**

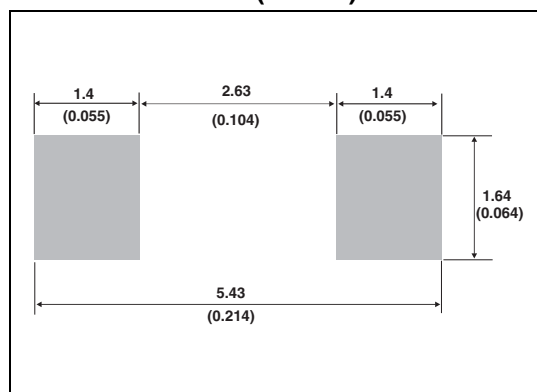

**Figure 18. Marking layout<sup>(1)</sup>**

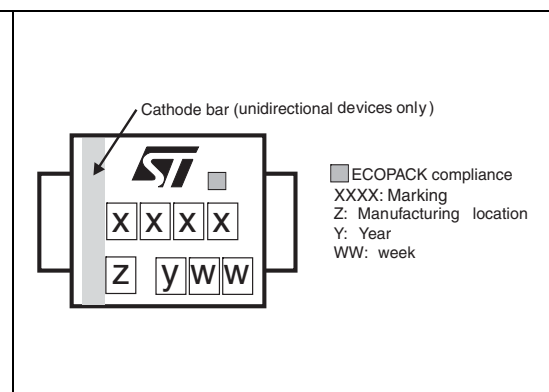

1. Marking layout can vary according to assembly location.

Table 4. Marking

Order code	Marking	Order code	Marking
SM4T6V7AY	AEY	SM4T6V7CAY	AAY
SM4T7V6AY	DUCY	SM4T7V5CAY	DBCY
SM4T10AY	DUHY	SM4T10CAY	DBHY
SM4T12AY	AXY	SM4T12CAY	ACY
SM4T14AY	DUKY	SM4T14CAY	DBKY
SM4T15AY	BGY	SM4T15CAY	BHY
SM4T18AY	BMY	SM4T18CAY	AJY
SM4T21AY	DUQY	SM4T21CAY	DBQY
SM4T23AY	DURY	SM4T23CAY	DBRY
SM4T26AY	DUSY	SM4T26CAY	DBSY
SM4T28AY	DUTY	SM4T28CAY	DBTY
SM4T30AY	DUJY	SM4T30CAY	DBUY
SM4T33AY	CGY	SM4T33CAY	CHY
SM4T35AY	CKY	SM4T35CAY	CLY
SM4T39AY	CMY	SM4T39CAY	CNY
SM4T47AY	DUZY	SM4T47CAY	DBZY
SM4T50AY	EUAY	SM4T50CAY	EBAY
SM4T56AY	CXY	SM4T56CAY	CYY
SM4T68AY	EUFY	SM4T68CAY	EBFY
SM4T82AY	EUIY	SM4T82CAY	EBIY

## 5 Ordering information

**Table 5. Ordering information**

Order code	Marking	Package	Weight	Base qty	Delivery mode
SM4TxxxAY/CAY <sup>(1)</sup>	See <a href="#">Table 4 on page 10</a>	SMA	0.072 g	5000	Tape and reel

1. Where xxx is nominal value of  $V_{BR}$  and A or CA indicates unidirectional or bidirectional version. See [Table 2](#) for list of available devices and their order codes

## 6 Revision history

**Table 6. Document revision history**

Date	Revision	Changes
08-Sep-2010	1	Initial release.
09-Nov-2011	2	Added order codes in Table 2 and Table 4. Updated Figure 5, 6 and 7.
27-Mar-2012	3	Added footnote on page 1.
05-Oct-2015	4	Updated <a href="#">Table 1</a> .

**IMPORTANT NOTICE – PLEASE READ CAREFULLY**

STMicroelectronics NV and its subsidiaries ("ST") reserve the right to make changes, corrections, enhancements, modifications, and improvements to ST products and/or to this document at any time without notice. Purchasers should obtain the latest relevant information on ST products before placing orders. ST products are sold pursuant to ST's terms and conditions of sale in place at the time of order acknowledgement.

Purchasers are solely responsible for the choice, selection, and use of ST products and ST assumes no liability for application assistance or the design of Purchasers' products.

No license, express or implied, to any intellectual property right is granted by ST herein.

Resale of ST products with provisions different from the information set forth herein shall void any warranty granted by ST for such product.

ST and the ST logo are trademarks of ST. All other product or service names are the property of their respective owners.

Information in this document supersedes and replaces information previously supplied in any prior versions of this document.

© 2015 STMicroelectronics – All rights reserved

## Looking for pricing, stock, or lifecycle information?

Click below to explore more details on WIN SOURCE:

-  [View SM4T47AY on WIN SOURCE](#)
-  [STMicroelectronics Information](#)

## Optimize Your Supply Chain with WIN SOURCE Solutions

-  Global Sourcing Solution
-  Obsolete Management
-  Cost Control Management
-  Shortage Management
-  Alternative Solution
-  Excess Inventory Management