



**THE DATASHEET OF
SC621AULTRT**



POWER MANAGEMENT

Features

- Input supply voltage range — 3.0V to 5.5V
- Charge pump modes — 1x, 1.5x and 2x
- Four programmable current sinks with 32 steps from 0.5mA to 25mA
- Flash LED — 400mA max in flash mode, 250mA max continuous for spotlight
- Two programmable 200mA low-noise LDO regulators
- Charge pump frequency — 250kHz
- I²C compatible interface — up to 400kHz
- Backlight current accuracy ±1.5% typical
- Backlight current matching ±0.5% typical
- Programmable fade-in/fade-out for main backlight
- External flash control pin to sync with camera
- Optional 1s flash time out
- Automatic sleep mode (LEDs off) — I_Q = 100μA
- Low shutdown current — 0.1μA (typical)
- Ultra-thin package — 3mm x 3mm x 0.6mm
- Lead-free and halogen-free
- WEEE and RoHS compliant

Applications

- Cellular phone backlighting and flash
- PDA backlighting and flash
- Camera I/O and core power

Description

The SC621A is a high efficiency charge pump LED driver using Semtech's proprietary mAhXLife™ technology. Performance is optimized for use in single-cell Li-ion battery applications.

The charge pump provides backlight current in conjunction with four matched current sinks. It also can supply continuous or bursted current to a flash LED using the dedicated flash driver current sink. The load and supply conditions determine whether the charge pump operates in 1x, 1.5x, or 2x mode. An optional fading feature that gradually adjusts the backlight current is provided to simplify control software. A flash-timeout feature disables the flash if active for longer than 1 second. The SC621A also provides two low-dropout, low-noise linear regulators for powering a camera module or other peripheral circuits.

The SC621A uses an I²C compatible serial interface. The interface controls all functions of the device, including backlight and flash currents as well as two LDO voltage outputs. The flash/spotlight output is triggered via either the I²C interface or a dedicated pin.

In sleep mode, the device reduces quiescent current to 100μA while continuing to monitor the serial interface. The two LDOs can be enabled when the device is in sleep mode. Total current reduces to 0.1μA in shutdown.

Typical Application Circuit

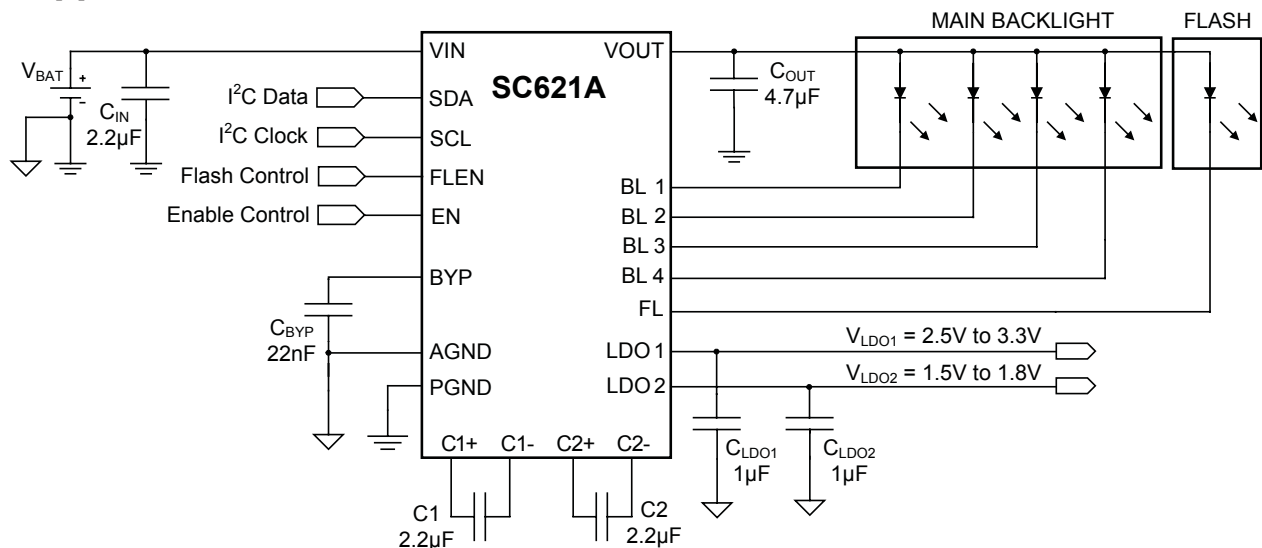

Pin Configuration

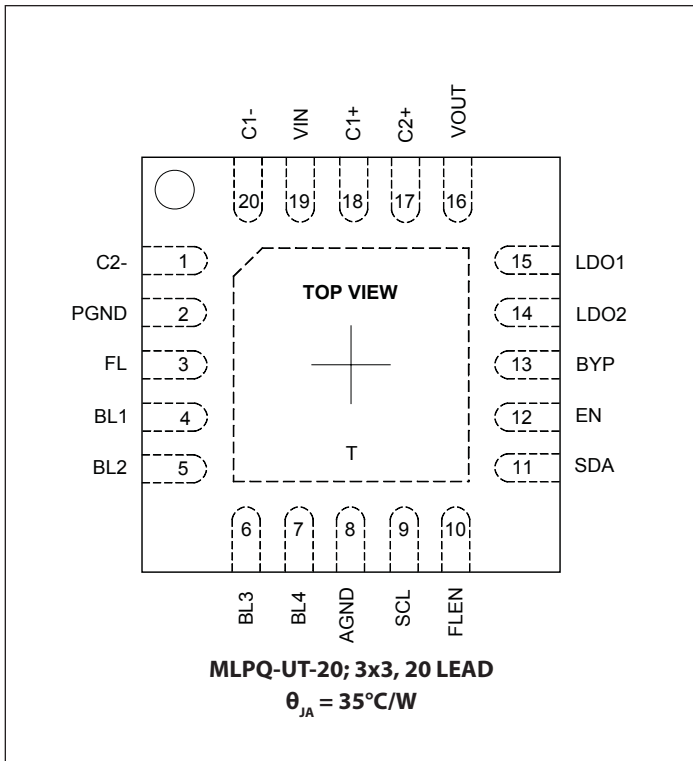

Ordering Information

| Device | Package |
|-------------------------------|------------------|
| SC621AULTRT ⁽¹⁾⁽²⁾ | MLPQ-UT-20 3x3 |
| SC621AEVB | Evaluation Board |

Notes:

- (1) Available in tape and reel only. A reel contains 3,000 devices.
- (2) Lead-free packaging only. Device is WEEE and RoHS compliant, and halogen-free.

Marking Information

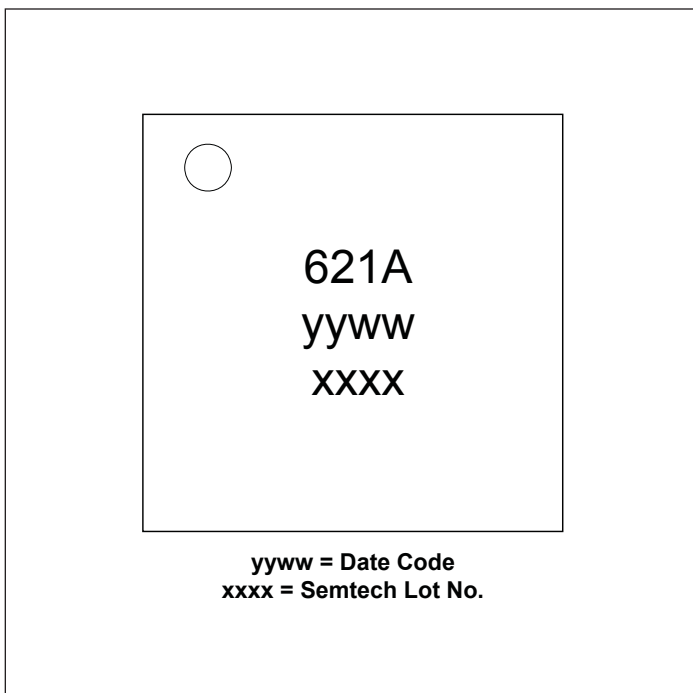

Absolute Maximum Ratings

| | |
|------------------------------------------------|----------------------------------|
| V _{IN} (V) | -0.3 to +6.0 |
| V _{OUT} (V) | -0.3 to +6.0 |
| C1+, C2+ (V) | -0.3 to (V _{OUT} + 0.3) |
| Pin Voltage - All Other Pins (V) | -0.3 to (V _{IN} + 0.3) |
| V _{OUT} Short Circuit Duration | Continuous |
| VLDO1, VLDO2 Short Circuit Duration | Continuous |
| ESD Protection Level ⁽¹⁾ (kV) | 2 |

Recommended Operating Conditions

| | |
|---------------------------------------------------|-------------------------------|
| Ambient Temperature Range (°C) | -40 ≤ T _A ≤ +85 |
| V _{IN} (V) | 3.0 ≤ V _{IN} ≤ 5.5 |
| V _{OUT} (V) | 2.5 ≤ V _{OUT} ≤ 5.25 |
| Voltage Difference between any two LEDs (V) | ≤ 1.2 |

Thermal Information

| | |
|--------------------------------------------------------------------|-------------|
| Thermal Resistance, Junction to Ambient ⁽²⁾ (°C/W) | 35 |
| Maximum Junction Temperature (°C) | +150 |
| Storage Temperature Range (°C) | -65 to +150 |
| Peak IR Reflow Temperature (10s to 30s) (°C) | +260 |

Exceeding the above specifications may result in permanent damage to the device or device malfunction. Operation outside of the parameters specified in the Electrical Characteristics section is not recommended.

NOTES:

(1) Tested according to JEDEC standard JESD22-A114-B.

(2) Calculated from package in still air, mounted to 3" x 4.5", 4 layer FR4 PCB with thermal vias under the exposed pad per JESD51 standards.

Electrical Characteristics

Unless otherwise noted, T_A = +25°C for Typ, -40°C to +85°C for Min and Max, T_{J(MAX)} = 125°C, V_{IN} = 3.0V to 4.2V, C_{IN} = C₁ = C₂ = 2.2μF, C_{OUT} = 4.7μF (ESR = 0.03Ω), ΔV_F ≤ 1.2V⁽¹⁾

| Parameter | Symbol | Conditions | Min | Typ | Max | Units |
|-----------------------------------------|----------------------|-------------------------------------------------------------------------------------------------------------------|------|------|------|-------|
| Supply Specifications | | | | | | |
| Shutdown Current | I _{Q(OFF)} | Shutdown, V _{IN} = 4.2V | | 0.1 | 2 | μA |
| Total Quiescent Current | I _Q | Sleep (LDOs off), EN = V _{IN} | | 100 | 160 | μA |
| | | Sleep (LDOs on), EN = V _{IN} , V _{IN} > (V _{LDO} + 300mV), I _{LDO} ≤ 200mA | | 220 | 340 | |
| | | Charge pump in 1x mode, 4 backlights on | | 3.8 | 4.65 | mA |
| | | Charge pump in 1.5x mode, 4 backlights on | | 4.6 | 5.85 | |
| Charge pump in 2x mode, 4 backlights on | | 4.6 | 5.85 | | | |
| Fault Protection | | | | | | |
| Output Short Circuit Current Limit | I _{OUT(SC)} | V _{OUT} pin shorted to GND | | 300 | | mA |
| Over-Temperature | T _{OTP} | | | 160 | | °C |
| Flash Mode Safety Timer ⁽²⁾ | t _{FL(MAX)} | Flash sink active | 0.75 | 1.00 | 1.25 | s |

Electrical Characteristics (continued)

| Parameter | Symbol | Conditions | Min | Typ | Max | Units |
|-------------------------------------------------|----------------------|-------------------------------------------------------------------------|------|-----------|------|---------|
| Fault Protection (continued) | | | | | | |
| Charge Pump Over-Voltage Protection | V_{OVP} | VOUT pin open circuit, $V_{OUT} = V_{OVP}$ rising threshold | 5.3 | 5.7 | 6.0 | V |
| Undervoltage Lockout | V_{UVLO} | Decreasing V_{IN} | | 2.4 | | V |
| | $V_{UVLO-HYS}$ | | | 300 | | mV |
| Charge Pump Electrical Specifications | | | | | | |
| Maximum Total Output Current | $I_{OUT(MAX)}$ | $V_{IN} > 3.4V$, sum of all active LED currents, $V_{OUT(MAX)} = 4.0V$ | 500 | | | mA |
| Backlight Current Setting | I_{BL} | Nominal setting for BL1 thru BL4 | 0.5 | | 25 | mA |
| Flash Current Setting | I_{FL} | Nominal setting for FL | 50 | | 400 | mA |
| Backlight Current Accuracy | I_{BL_ACC} | $V_{IN} = 3.7V$, $I_{BL} = 12mA$, $T_A = 25^\circ C$ | -8 | ± 1.5 | +8 | % |
| Backlight Current Matching | I_{BL-BL} | $V_{IN} = 3.7V$, $I_{BL} = 12mA^{(3)}$ | -3.5 | ± 0.5 | +3.5 | % |
| Flash Current Accuracy | I_{FL_ACC} | $V_{IN} = 3.7V$, $I_{FL} = 400mA$, $T_A = 25^\circ C$ | -15 | | +15 | % |
| 1x Mode to 1.5x Mode Falling Transition Voltage | $V_{TRANS1x}$ | $I_{OUT} = 40mA$, $I_{BLn} = 10mA$, $V_{OUT} = 3.2V$ | | 3.27 | | V |
| 1.5x Mode to 1x Mode Hysteresis | V_{HYST1x} | $I_{OUT} = 40mA$, $I_{BLn} = 10mA$, $V_{OUT} = 3.2V$ | | 250 | | mV |
| 1.5x Mode to 2x Mode Falling Transition Voltage | $V_{TRANS1.5x}$ | $I_{OUT} = 40mA$, $I_{BLn} = 10mA$, $V_{OUT} = 4.0V^{(4)}$ | | 2.92 | | V |
| 2x Mode to 1.5x Mode Hysteresis | $V_{HYST1.5x}$ | $I_{OUT} = 40mA$, $I_{BLn} = 10mA$, $V_{OUT} = 4.0V^{(4)}$ | | 300 | | mV |
| Current Sink Off-State Leakage Current | I_{BLn} | $V_{IN} = V_{BLn} = 4.2V$ | | 0.1 | 1 | μA |
| Pump Frequency | f_{PUMP} | $V_{IN} = 3.2V$ | | 250 | | kHz |
| LDO Electrical Specifications | | | | | | |
| LDO1 Voltage Setting | V_{LDO1} | Range of nominal settings in 100mV increments | 2.5 | | 3.3 | V |
| LDO2 Voltage Setting | V_{LDO2} | Range of nominal settings in 100mV increments | 1.5 | | 1.8 | V |
| LDO1, LDO2 Output Voltage Accuracy | V_{LDO1}, V_{LDO2} | $V_{IN} = 3.7V$, $I_{LDO} = 1mA$ | -3.5 | ± 3 | +3.5 | % |
| Line Regulation | ΔV_{LINE} | LDO1, $I_{LDO1} = 1mA$, $V_{OUT} = 2.8V$ | | 2.1 | 7.2 | mV |
| | | LDO2, $I_{LDO2} = 1mA$, $V_{OUT} = 1.8V$ | | 1.3 | 4.8 | |

Electrical Characteristics (continued)

| Parameter | Symbol | Conditions | Min | Typ | Max | Units |
|-------------------------------------------------------------------------------------------------------------------------------------------------------|-------------------|-------------------------------------------------------------------------------------------------------------------------------|------|-----|-----|---------------|
| LDO Electrical Specifications (continued) | | | | | | |
| Load Regulation | ΔV_{LOAD} | $V_{LDO1} = 3.3V, V_{IN} = 3.7V,$ $I_{LDO1} = 1mA \text{ to } 100mA$ | | | 25 | mV |
| | | $V_{LDO2} = 1.8V, V_{IN} = 3.7V,$ $I_{LDO2} = 1mA \text{ to } 100mA$ | | | 20 | |
| Dropout Voltage ⁽⁵⁾ | V_D | $I_{LDO1} = 100mA$ | | 100 | 150 | mV |
| Current Limit | I_{LIM} | | 200 | | | mA |
| Power Supply Rejection Ratio | $PSRR_{LDO1}$ | $2.5V < V_{LDO1} < 3V, f < 1kHz, C_{BYP} = 22nF, I_{LDO1} = 50mA,$ $V_{IN} = 3.7V \text{ with } 0.5V_{P-P} \text{ ripple}$ | | 50 | | dB |
| | $PSRR_{LDO2}$ | $f < 1kHz, C_{BYP} = 22nF, I_{LDO2} = 50mA,$ $V_{IN} = 3.7V \text{ with } 0.5V_{P-P} \text{ ripple}$ | | 60 | | |
| Output Voltage Noise | e_{n-LDO1} | LDO1, $10Hz < f < 100kHz, C_{BYP} = 22nF, C_{LDO} = 1\mu F,$ $I_{LDO1} = 50mA, V_{IN} = 3.7V, 2.5V < V_{LDO1} < 3V$ | | 100 | | μV_{RMS} |
| | e_{n-LDO2} | LDO2, $10Hz < f < 100kHz, C_{BYP} = 22nF,$ $C_{LDO} = 1\mu F, I_{LDO2} = 50mA, V_{IN} = 3.7V$ | | 50 | | |
| Minimum Output Capacitor | $C_{LDO(MIN)}$ | | | 1 | | μF |
| Digital I/O Electrical Specifications (FLEN, EN) | | | | | | |
| Input High Threshold | V_{IH} | $V_{IN} = 5.5V$ | 1.6 | | | V |
| Input Low Threshold | V_{IL} | $V_{IN} = 3.0V$ | | | 0.4 | V |
| Input High Current | I_{IH} | $V_{IN} = 5.5V$ | -1 | | +1 | μA |
| Input Low Current | I_{IL} | $V_{IN} = 5.5V$ | -1 | | +1 | μA |
| I²C Interface | | | | | | |
| Interface complies with slave mode I ² C interface as described by Philips I ² C specification version 2.1 dated January, 2000. | | | | | | |
| Digital Input Voltage | V_{B-IL} | | | | 0.4 | V |
| | V_{B-IH} | | 1.6 | | | V |
| SDA Output Low Level | | $I_{DIN} (SDA) \leq 3mA$ | | | 0.4 | V |
| Digital Input Current | I_{B-IN} | | -0.2 | | 0.2 | μA |
| Hysteresis of Schmitt Trigger Inputs | V_{HYS} | | | 0.1 | | V |
| Maximum Glitch Pulse Rejection | t_{SP} | | | 50 | | ns |

Electrical Characteristics (continued)

| Parameter | Symbol | Conditions | Min | Typ | Max | Units |
|--------------------------------------------------------|---------------|-----------------------------------------------|-----|-----|-----|---------|
| I²C Interface (Continued) | | | | | | |
| I/O Pin Capacitance | C_{IN} | | | 10 | | pF |
| I²C Timing | | | | | | |
| Clock Frequency | f_{SCL} | | | 400 | 440 | kHz |
| SCL Low Period ⁽⁶⁾ | t_{LOW} | | 1.3 | | | μ s |
| SCL High Period ⁽⁶⁾ | t_{HIGH} | | 0.6 | | | μ s |
| Data Hold Time ⁽⁶⁾ | t_{HD_DAT} | | 0 | | | μ s |
| Data Setup Time ⁽⁶⁾ | t_{SU_DAT} | | 100 | | | μ s |
| Setup Time for Repeated START Condition ⁽⁶⁾ | t_{SU_STA} | | 0.6 | | | μ s |
| Hold Time for Repeated START Condition ⁽⁶⁾ | t_{HD_STA} | | 0.6 | | | μ s |
| Setup Time for STOP Condition ⁽⁶⁾ | t_{SU_STO} | | 0.6 | | | μ s |
| Bus-Free Time Between STOP and START ⁽⁶⁾ | t_{BUF} | | 1.3 | | | μ s |
| Interface Start-up Time ⁽⁶⁾ | t_{EN} | Bus Start-up Time After EN Pin is Pulled High | | | 1 | ms |

Notes:

- (1) ΔV_f is the voltage difference between any two LEDs.
- (2) Once tripped, flash output will remain disabled until FLEN pin is cycled or reset via serial interface.
- (3) Current matching equals $\pm [I_{BL(MAX)} - I_{BL(MIN)}] / [I_{BL(MAX)} + I_{BL(MIN)}]$.
- (4) Test voltage is $V_{OUT} = 4.0V$ — a relatively extreme LED voltage — to force a transition during test. Typically $V_{OUT} = 3.2V$ for white LEDs.
- (5) Dropout is defined as $(V_{IN} - V_{LDO1})$ when V_{LDO1} drops 100mV from nominal. Dropout does not apply to LDO2 since it has a maximum output voltage of 1.8V.
- (6) Guaranteed by design

Typical Characteristics

Battery Current (4 LEDs) — 25mA Each

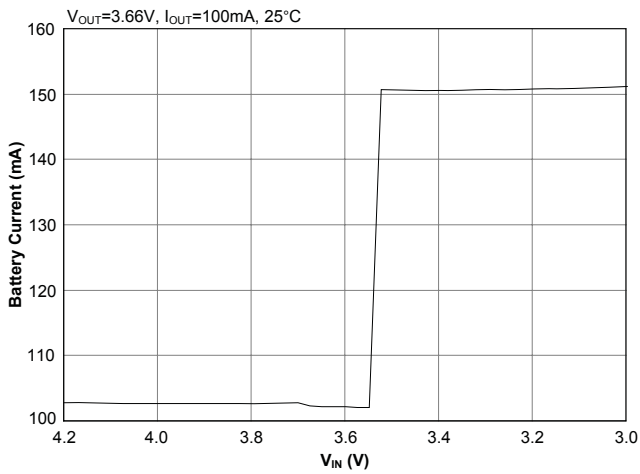

Battery Current (4 LEDs) — 12mA Each

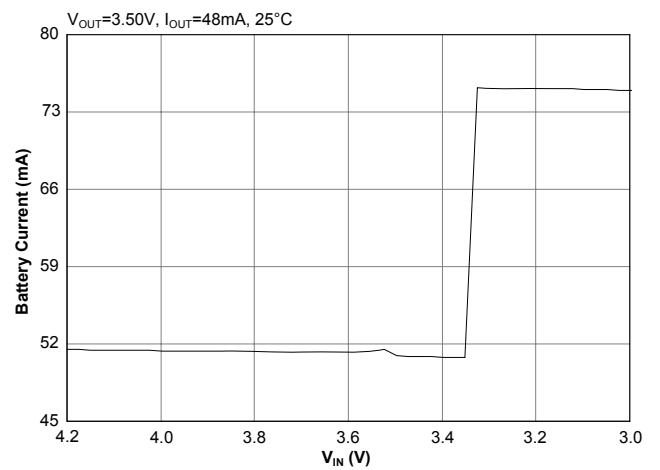

Backlight Efficiency (4 LEDs) — 25mA Each

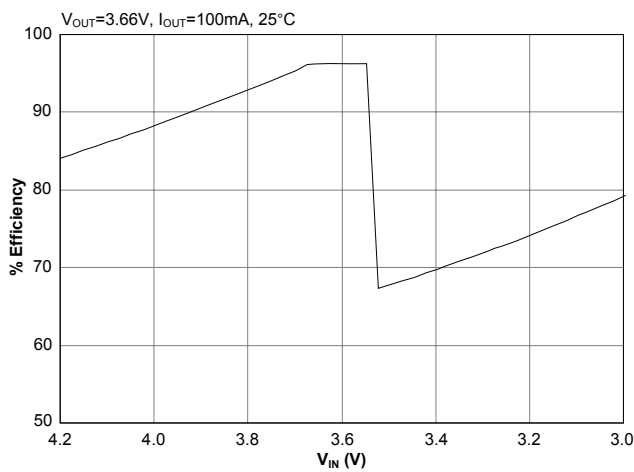

Backlight Efficiency (4 LEDs) — 12mA Each

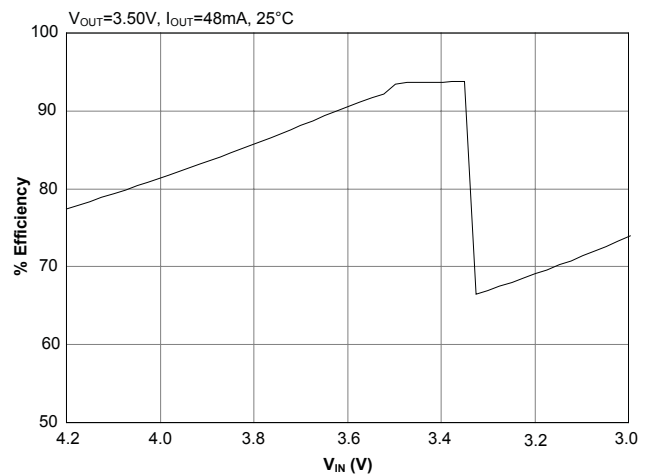

Battery Current (4 LEDs) — 5.0mA Each

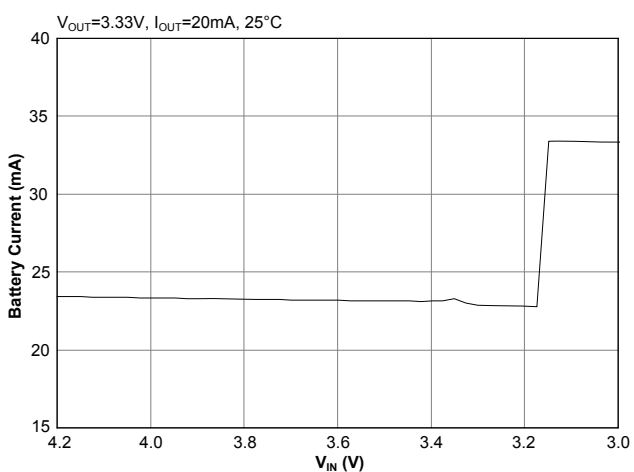

Backlight Efficiency (4 LEDs) — 5.0mA Each

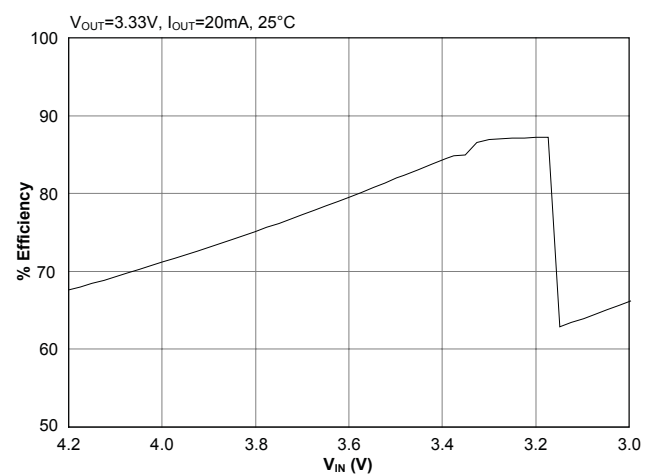

Typical Characteristics (continued)

Flash Current — 300mA

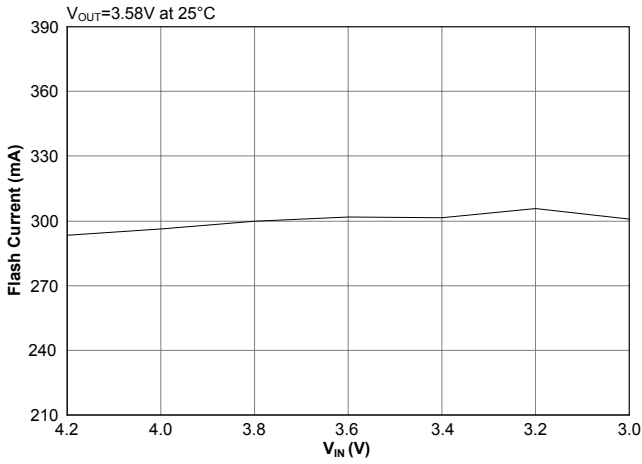

Flash Current — 400mA

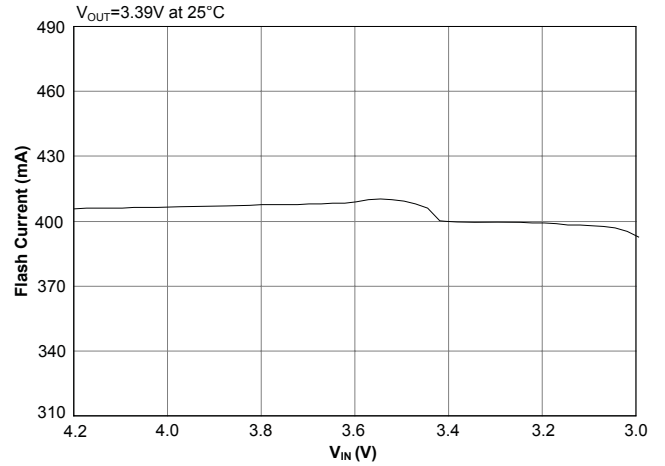

Spotlight Current — 50mA

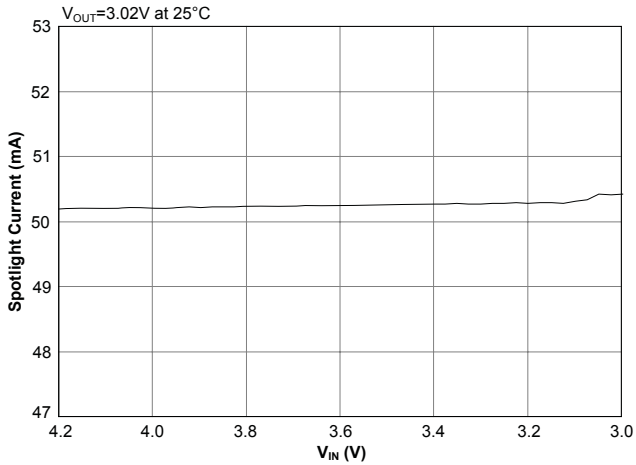

Spotlight Current — 250mA

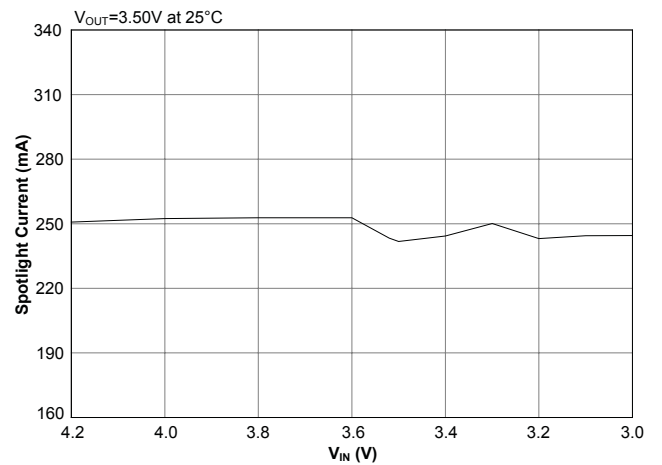

PSRR vs. Frequency (LDO1)

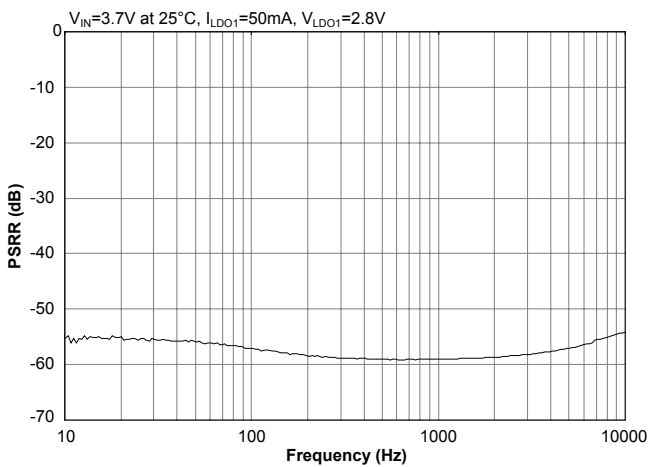

PSRR vs. Frequency (LDO2)

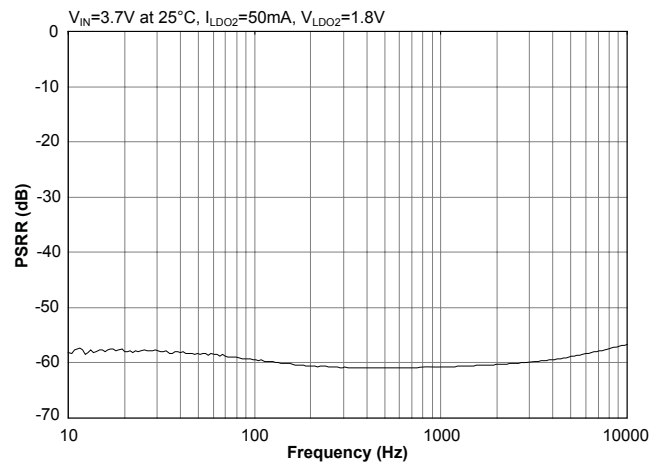

Typical Characteristics (continued)

Load Regulation (LDO1)

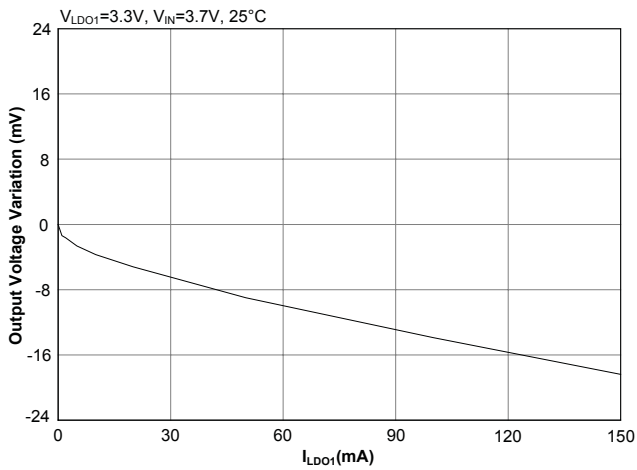

Load Regulation (LDO2)

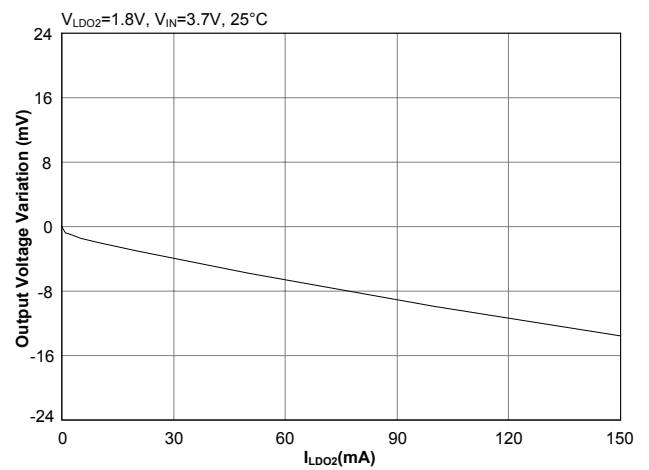

Noise vs Load Current (LDO1)

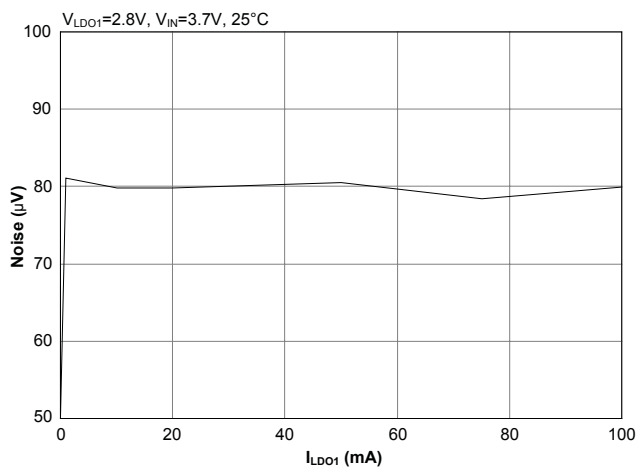

Noise vs Load Current (LDO2)

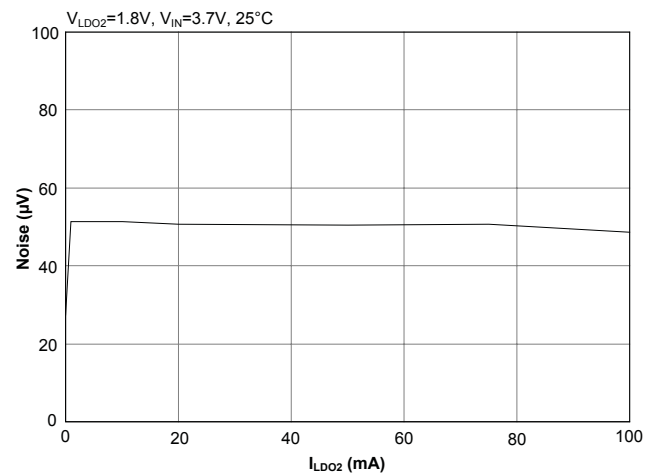

Line Regulation (LDO1)

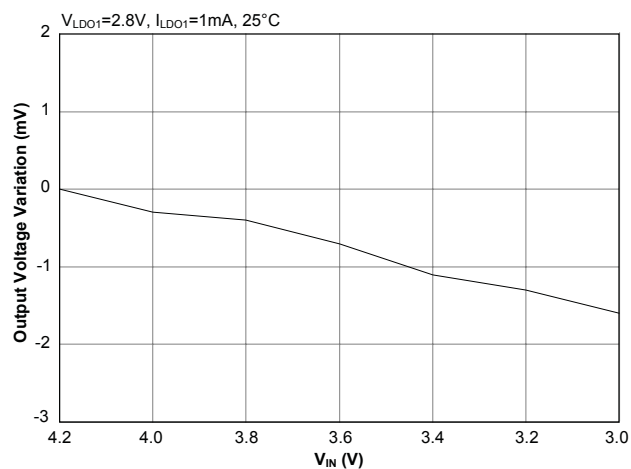

Line Regulation (LDO2)

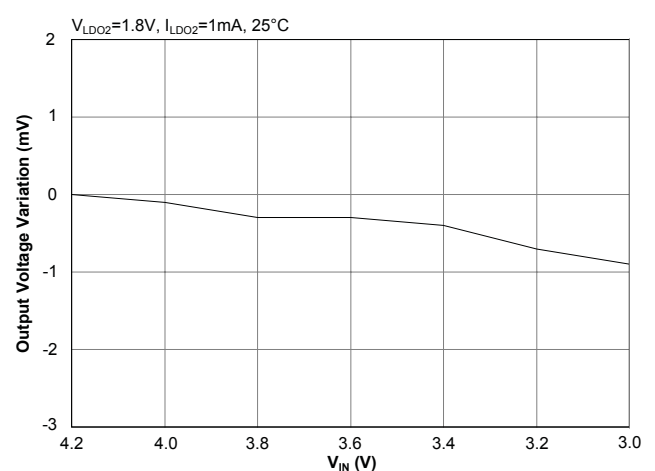

Typical Characteristics (continued)

Load Transient Response (LDO1) — Rising Edge

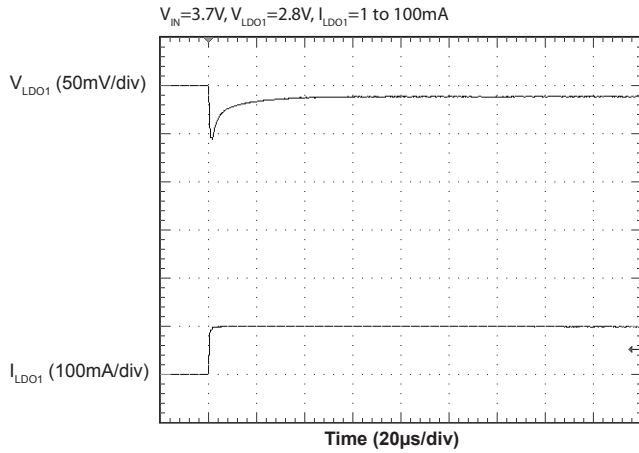

Load Transient Response (LDO2) — Rising Edge

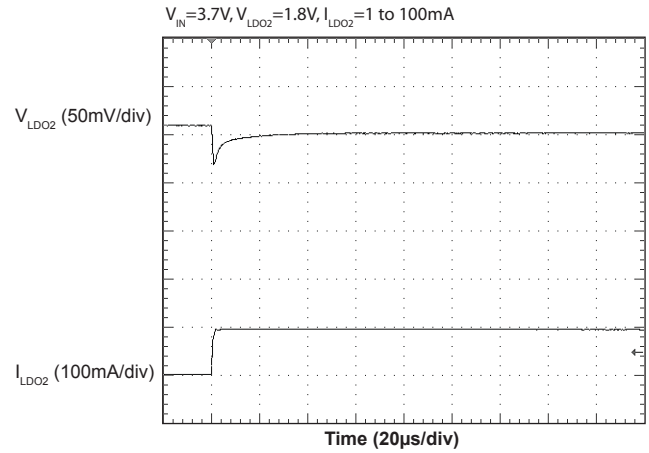

Load Transient Response (LDO1) — Falling Edge

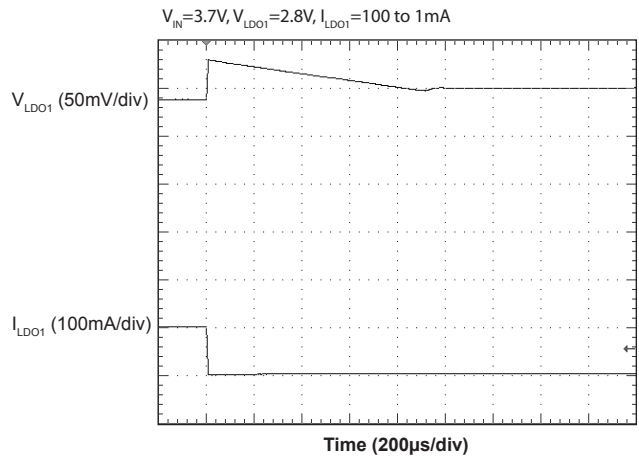

Load Transient Response (LDO2) — Falling Edge

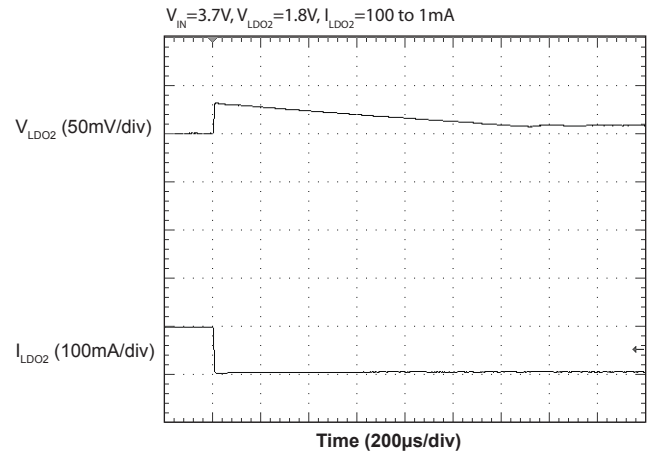

Typical Characteristics (continued)

Output Short Circuit Current Limit

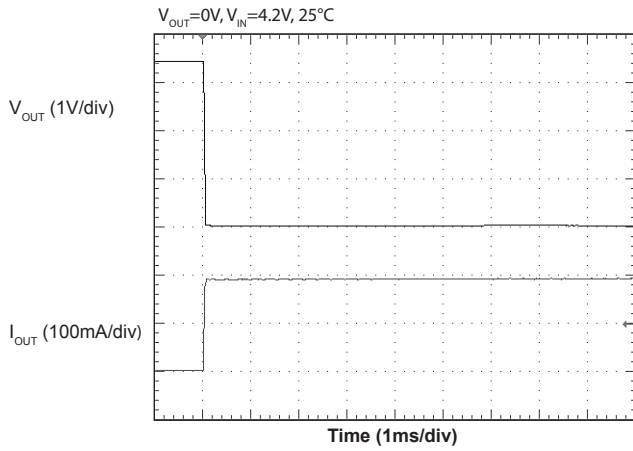

Flash Mode Safety Timer

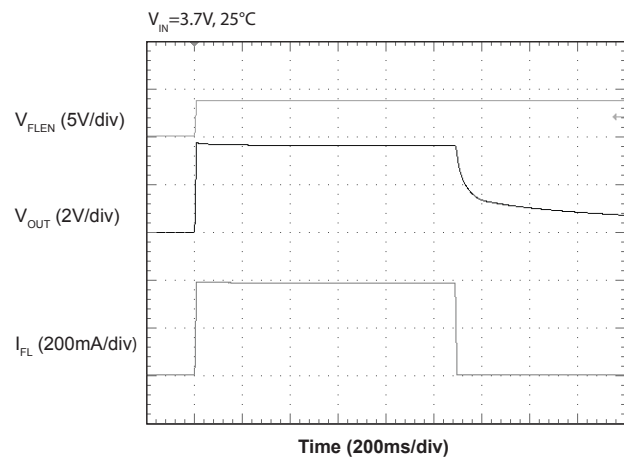

Output Open Circuit Protection

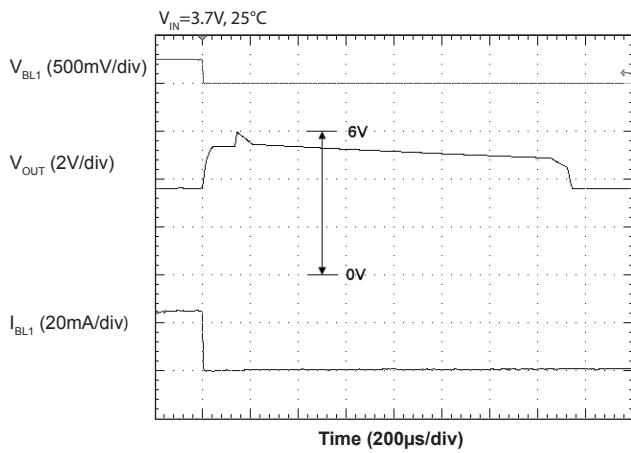

Flash Current Pulse

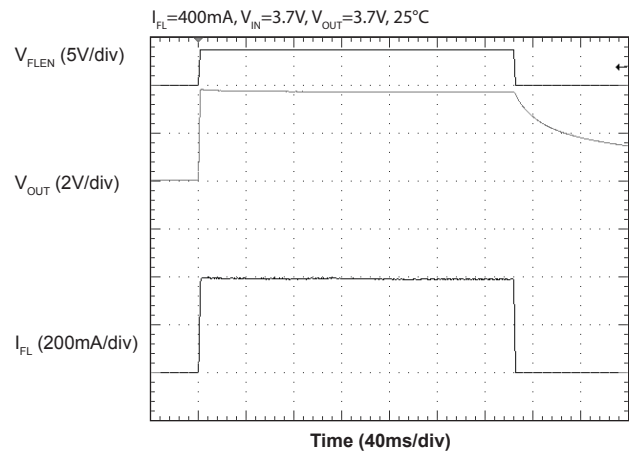

Pin Descriptions

| Pin # | Pin Name | Pin Function |
|-------|-------------|--------------------------------------------------------------------------------------------------------------------------------------------------------------------------|
| 1 | C2- | Negative connection to bucket capacitor 2 — requires a 2.2 μ F capacitor connected to C2+ |
| 2 | PGND | Ground pin for high current charge pump and Flash LED driver |
| 3 | FL | Current sink output for flash LED(s) |
| 4 | BL1 | Current sink output for main backlight LED 1 — leave this pin open if unused |
| 5 | BL2 | Current sink output for main backlight LED 2 — leave this pin open if unused |
| 6 | BL3 | Current sink output for main backlight LED 3 — leave this pin open if unused |
| 7 | BL4 | Current sink output for main backlight LED 4 — leave this pin open if unused |
| 8 | AGND | Analog ground pin — connect to ground and separate from PGND current |
| 9 | SCL | I ² C clock input pin |
| 10 | FLEN | Control pin for flash LED(s) — high = ON, low = OFF |
| 11 | SDA | I ² C bi-directional data pin — used for read and write operations for all internal registers (refer to Register Map and I ² C Interface sections) |
| 12 | EN | Chip enable — active high — low state resets all registers (see register map table) |
| 13 | BYP | Bypass pin for voltage reference — connect with a 22nF capacitor to AGND |
| 14 | LDO2 | Output of LDO2 — connect with a 1 μ F capacitor to AGND |
| 15 | LDO1 | Output of LDO1 — connect with a 1 μ F capacitor to AGND |
| 16 | VOUT | Charge pump output — all LED anode pins should be connected to this pin — requires a 4.7 μ F capacitor to PGND |
| 17 | C2+ | Positive connection to bucket capacitor 2 — requires a 2.2 μ F capacitor connected to C2- |
| 18 | C1+ | Positive connection to bucket capacitor 1 — requires a 2.2 μ F capacitor connected to C1- |
| 19 | VIN | Battery voltage input — connect with a 2.2 μ F capacitor to PGND |
| 20 | C1- | Negative connection to bucket capacitor 1 — requires a 2.2 μ F capacitor connected to C1+ |
| T | THERMAL PAD | Thermal pad for heatsinking purposes — connect to ground plane using multiple vias — not connected internally |

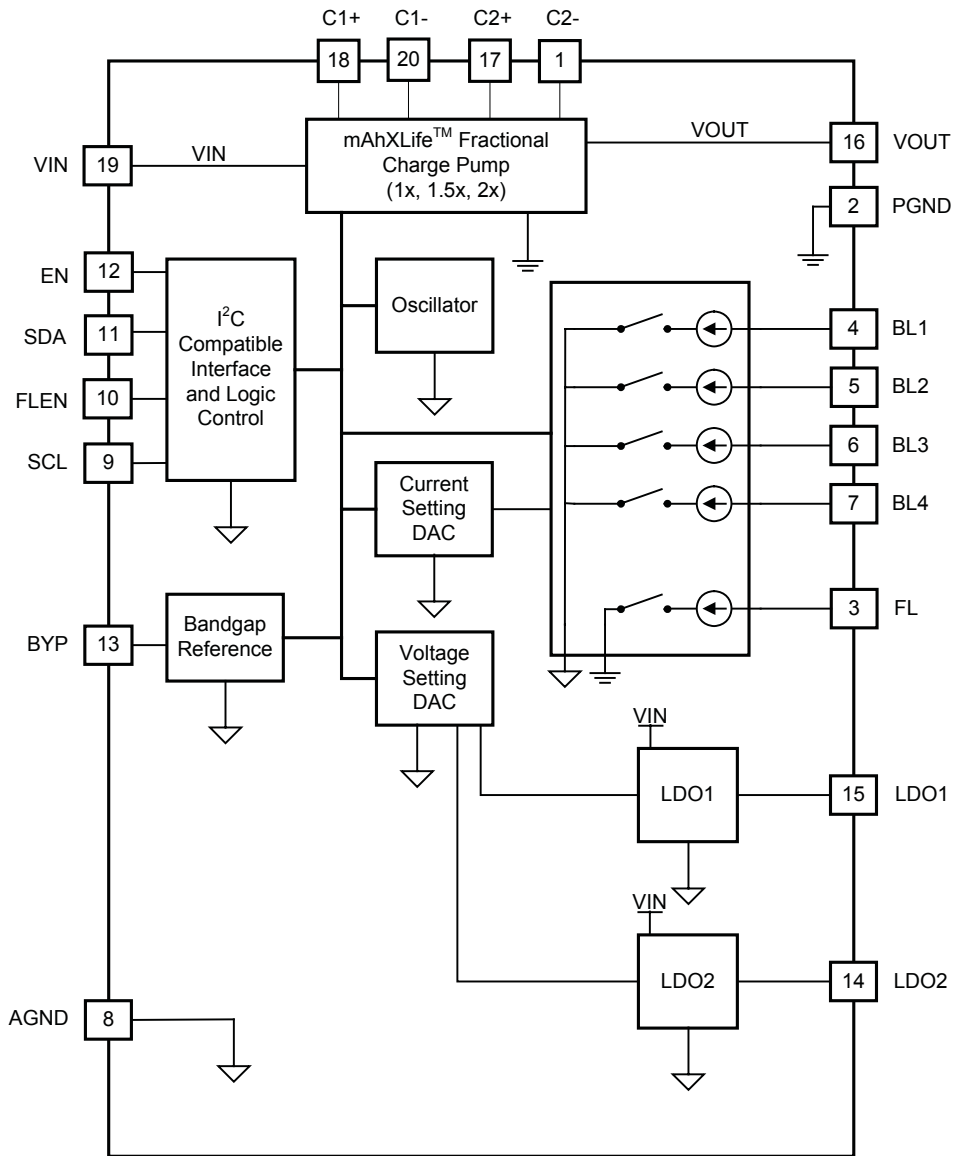
Block Diagram

Applications Information

General Description

This design is optimized for handheld applications supplied from a single Li-Ion cell and includes the following key features:

- A high efficiency fractional charge pump that supplies power to all LEDs
- Four matched current sinks that control LED backlighting current, with 0.5mA to 25mA per LED
- An LED flash output that provides up to 400mA of momentary current or up to 250mA of continuous spotlight current
- Two adjustable LDOs with outputs ranging from 2.5V to 3.3V for LDO1 and 1.5V to 1.8V for LDO2, adjustable in 100mV increments
- An I²C compatible interface that provides control of all device functions

High Current Fractional Charge Pump

The backlight and flash outputs are supported by a high efficiency, high current fractional charge pump output at the VOUT pin. The charge pump multiplies the input voltage by 1, 1.5, or 2 times. The charge pump switches at a fixed frequency of 250kHz in 1.5x and 2x modes and is disabled in 1x mode to save power and improve efficiency.

The mode selection circuit automatically selects the 1x, 1.5x or 2x mode based on circuit conditions. Circuit conditions such as low input voltage, high output current, or high LED voltage place a higher demand on the charge pump output. A higher numerical mode may be needed momentarily to maintain regulation at the VOUT pin during intervals of high demand, such as the high current of an LED flash or the droop at the VIN pin during a supply voltage transient. The charge pump responds to these momentary high demands, setting the charge pump to the optimum mode (1x, 1.5x or 2x), as needed to deliver the output voltage and load current while optimizing efficiency. Hysteresis is provided to prevent mode toggling.

The charge pump requires two bucket capacitors for low ripple operation. One capacitor must be connected

between the C1+ and C1- pins and the other must be connected between the C2+ and C2- pins as shown in the typical application circuit diagram. These capacitors should be equal in value, with a minimum capacitance of 2.2 μ F to support the charge pump current requirements. The device also requires a 2.2 μ F capacitor on the VIN pin and a 4.7 μ F capacitor on the VOUT pin to minimize noise and support the output drive requirements. Capacitors with X7R or X5R ceramic dielectric are strongly recommended for their low ESR and superior temperature and voltage characteristics. Y5V capacitors should not be used as their temperature coefficients make them unsuitable for this application.

LED Backlight Current Sinks

The backlight current is set via the I²C compatible interface. The current is regulated to one of 32 values between 0.5mA and 25mA. The step size varies depending upon the current setting. Between 0.5mA and 12mA, the step size is 0.5mA. The step size increases to 1mA for settings between 12mA and 15mA and 2mA for settings greater than 15mA. This feature allows finer adjustment for dimming functions in the low current setting range and coarse adjustment at higher current settings where small current changes are not visibly noticeable in LED brightness.

All backlight current sinks have matched currents, even when there is variation in the forward voltages (ΔV_F) of the LEDs. A ΔV_F of 1.2V is supported when the input voltage is at 3.0V. Higher ΔV_F LED mis-match is supported when V_{IN} is higher than 3.0V. All current sink outputs are compared and the lowest output is used for setting the voltage regulation at the VOUT pin. This is done to ensure that sufficient bias exists for all LEDs, including the flash LED.

The backlight LEDs default to the off state upon power-up. For backlight applications using less than four LEDs, any unused output must be left open and the unused LED driver must remain disabled. When writing to the Backlight Enable Control register, a zero (0) must be written to the corresponding bit of any unused output.

Applications Information (continued)

Backlight Quiescent Current

The quiescent current required to operate all four backlights is reduced by 1.5mA when backlight current is set to 4.0mA or less. This feature results in higher efficiency under light-load conditions. Further reduction in quiescent current will result from using fewer than four LEDs.

Fade-In and Fade-Out

Backlight brightness can be set to automatically fade-in when current is set to increase and fade-out when current is set to decrease. When enabled with a new current setting, the current will step through each incremental setting between the old and new values. The result is a visually smooth change in brightness with a rate of fade that can be set to 8, 16, 24, or 32 ms per step.

LED Flash and Spotlight Current Sink

A single output current sink is provided to drive both flash and spotlight functions. In flash mode, this current sink provides up to 400mA for a flash LED or array of parallel LEDs. Flash current settings are in 50mA increments from 50mA to 400mA. The FLEN pin directly triggers the FLASH function when pulled high, or it can be wired to VIN to enable software control via the serial interface.

In spotlight mode, the output can be set for up to 250mA of continuous current. Settings are available in 50mA increments from 50mA to 250mA. Continuous operation above 250mA is not recommended due to high power dissipation.

Flash and Spotlight Safety Timer

A safety timer disables the flash and spotlight output current sink if the sink remains active for an extended period. The timer protects the SC621A and the LED from high power dissipation that can cause overheating. The timer's default state is on, but the timer may be disabled via the serial interface to allow continuous output current in spotlight mode. The safety timer affects only the FL pin and will turn off the sink after a period of 1 second. The

timer may be reset by either forcing the FLEN pin low or by resetting the Flash/Spotlight control bits via the interface.

Programmable LDO Outputs

Two low dropout (LDO) regulators are provided for camera module I/O and core power. Each LDO has at least 100mA of available load current with $\pm 3.5\%$ accuracy. The minimum current limit is 200mA, so outputs greater than 100mA are possible at somewhat reduced accuracy.

A 1 μ F, low ESR capacitor should be used as a bypass capacitor on each LDO output to reduce noise and ensure stability. In addition, it is recommended that a minimum 22nF capacitor be connected from the BYP pin to ground to minimize noise and achieve optimum power supply rejection. A larger capacitor can be used for this function, but at the expense of increasing turn-on time. Capacitors with X7R or X5R ceramic dielectric are strongly recommended for their low ESR and superior temperature and voltage characteristics. Y5V capacitors should not be used as their temperature coefficients make them unsuitable for this application.

Shutdown State

The device is disabled when the EN pin is low. All registers are reset to default condition when EN is low.

Sleep Mode

When all LEDs are off, sleep mode is activated. This is a reduced current mode that helps minimize overall current consumption by turning off the clock and the charge pump while continuing to monitor the serial interface for commands. Both LDOs can be powered up while in sleep mode.

I²C Compatible Interface Functions

All device functions can be controlled via the I²C compatible interface. The interface is described in detail in the Serial Interface section of the datasheet.

Applications Information (continued)

Protection Features

The SC621A provides several protection features to safeguard the device from catastrophic failures. These features include:

- Output Open Circuit Protection
- Over-Temperature Protection
- Charge Pump Output Current Limit
- LDO Current Limit
- LED Float Detection

Output Open Circuit Protection

Over-Voltage Protection (OVP) is provided at the VOUT pin to prevent the charge pump from producing an excessively high output voltage. In the event of an open circuit at VOUT, the charge pump runs in open loop and the voltage rises up to the OVP limit. OVP operation is hysteretic, meaning the charge pump will momentarily turn off until V_{OUT} is sufficiently reduced. The maximum OVP threshold is 6.0V, allowing the use of a ceramic output capacitor rated at 6.3V with no fear of over-voltage damage.

Over-Temperature Protection

The Over-Temperature (OT) protection circuit helps prevent the device from overheating and experiencing a catastrophic failure. When the junction temperature exceeds 160°C, the device goes into thermal shutdown with all outputs disabled until the junction temperature is reduced. All register information is retained during thermal shutdown.

Charge Pump Output Current Limit

The device also limits the charge pump current at the VOUT pin. When VOUT is shorted to ground, the typical output current is 300mA. The current limiting is triggered by an output under-voltage lockout below 2V. The output returns to normal when the short is removed and VOUT is above 2.5V. Above 2.5V, a typical current limit of 300mA applies when the FL current sink is off and a typical current limit of 1A applies when the FL current sink is on.

LDO Current Limit

The device limits the output currents of LDO1 and LDO2 to help prevent it from overheating and to protect the loads. The minimum limit is 200mA, so load current greater than the rated 100mA can be used with degraded accuracy and larger dropout without tripping the current limit.

LED Float Detection

Float detect is a fault detection feature of the LED current sink outputs. If an output is programmed to be enabled and an open circuit fault occurs at any current sink output, that output will be disabled to prevent a sustained output OVP condition from occurring due to the resulting open loop. Float detect ensures device protection but does not ensure optimum performance. Unused LED outputs must be disabled to prevent an open circuit fault from occurring.

Applications Information (continued)

PCB Layout Considerations

The layout diagram in Figure 1 illustrates a proper two-layer PCB layout for the SC621A and supporting components. Following fundamental layout rules is critical for achieving the performance specified in the Electrical Characteristics table. The following guidelines are recommended when developing a PCB layout:

- Place all bypass and decoupling capacitors — C1, C2, CIN, COUT, CLDO1, CLDO2, and CBYP as close to the device as possible.
- All charge pump current passes through VIN, VOUT, and the bucket capacitor connection pins. Ensure that all connections to these pins make use of wide traces so that the resistive drop on each connection is minimized.
- The thermal pad should be connected to the ground plane using multiple vias to ensure proper thermal connection for optimal heat transfer.

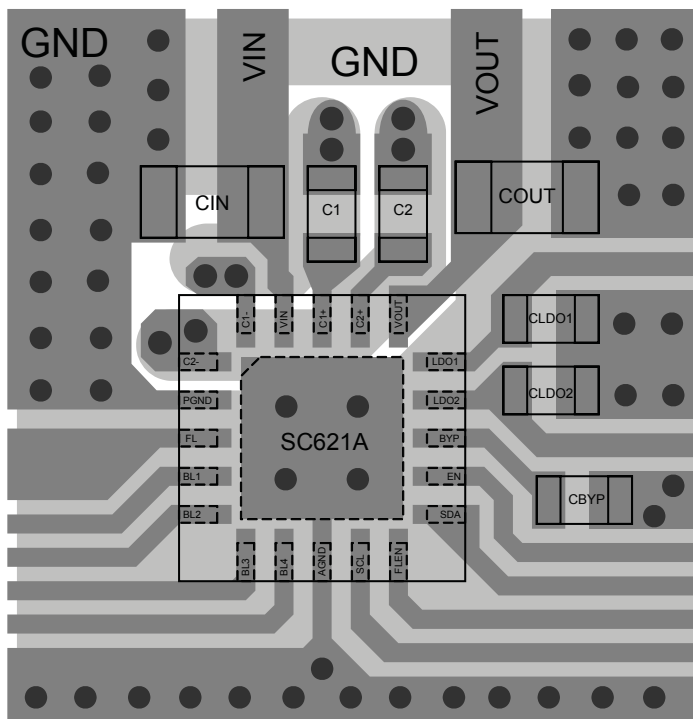

Figure 1 — Recommended PCB Layout

- Make all ground connections to a solid ground plane as shown in the example layout (Figure 3).
- If a ground layer is not feasible, the following groupings should be connected:
 - PGND — CIN, COUT
 - AGND — Ground Pad, CLDO1, CLDO2, CBYP
- If no ground plane is available, PGND and AGND should be routed back to the negative battery terminal as separate signals using thick traces. Joining the two ground returns at the terminal prevents large pulsed return currents from mixing with the low-noise return currents of the LDOs.
- Both LDO output traces should be made as wide as possible to minimize resistive losses.

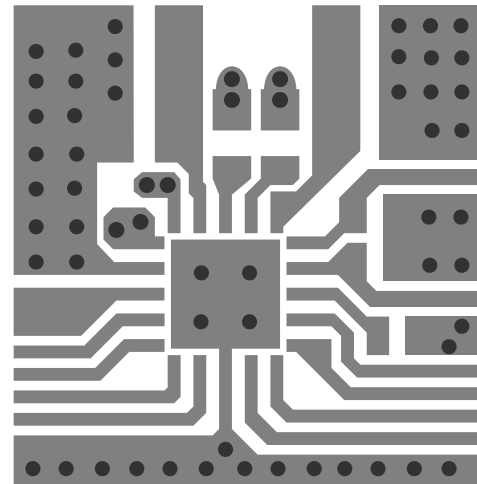

Figure 2 — Layer 1

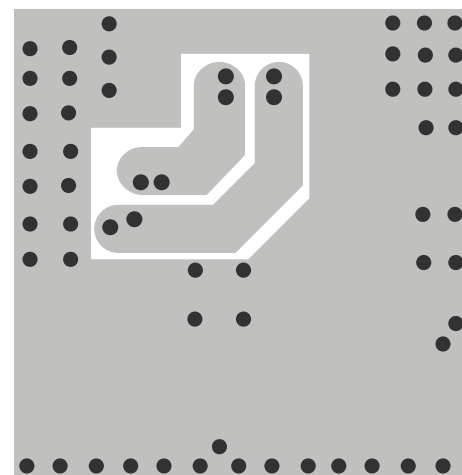

Figure 3 — Layer 2

Register Map

| Address | D7 | D6 | D5 | D4 | D3 | D2 | D1 | D0 | Reset Value | Description |
|---------|------------------|------------------|------------------|------------------|--------|--------|--------|---------|-------------|---------------------------|
| 0x00 | FADE_1 | FADE_0 | FADE_EN | BL_4 | BL_3 | BL_2 | BL_1 | BL_0 | 0x00 | Backlight Current Control |
| 0x01 | 0 ⁽¹⁾ | 0 ⁽¹⁾ | 0 ⁽¹⁾ | 0 ⁽¹⁾ | BLEN_4 | BLEN_3 | BLEN_2 | BLEN_1 | 0x00 | Backlight Enable Control |
| 0x02 | 0 ⁽¹⁾ | 0 ⁽¹⁾ | 0 ⁽¹⁾ | FLTO | FL_2 | FL_1 | FL_0 | FL/SPLB | 0x10 | Flash/Spotlight Control |
| 0x03 | 0 ⁽¹⁾ | LDO2_2 | LDO2_1 | LDO2_0 | LDO1_3 | LDO1_2 | LDO1_1 | LDO1_0 | 0x00 | LDO Control |

Notes:

(1) 0 = always write a 0 to these bits

Register and Bit Definitions

Backlight Current Control Register (0x00)

This register is used to set the currents for the backlight current sinks, as well as to enable and set the fade step rate. These current sinks need to be enabled in the Backlight Enable Control register to be active.

FADE[1:0]

These bits are used to set the rise/fall rate between two backlight currents as follows:

| FADE_1 | FADE_0 | Fade Feature Rise/Fall Rate (ms/step) |
|--------|--------|---------------------------------------|
| 0 | 0 | 32 |
| 0 | 1 | 24 |
| 1 | 0 | 16 |
| 1 | 1 | 8 |

The number of steps in changing the backlight current will be equal to the change in binary count of bits BL[4:0].

FADE_EN

This bit is used to enable or disable the fade feature. When the fade function is enabled and a new backlight current is set, the backlight current will change from its current

value to a new value set by bits BL[4:0] at a rate of 8ms to 32ms per step. A new backlight level cannot be written during an ongoing fade operation, but an ongoing fade operation may be cancelled by resetting the fade bit. Clearing the fade bit during an ongoing fade operation changes the backlight current immediately to the value of BL[4:0]. The number of counts to complete a fade operation equals the difference between the old and new backlight values to increment or decrement the BL[4:0] bits. If the fade bit is cleared, the current level will change immediately without the fade delay. The rate of fade may be changed dynamically, even while a fade operation is active, by writing new values to the FADE_1 and FADE_0 bits. The total fade time is determined by the number of steps between old and new backlight values, multiplied by the rate of fade in ms/step. The longest elapsed time for a full scale fade-out of the backlight is nominally 1.024 seconds when the default interval of 32ms is used.

Register and Bit Definitions (continued)

BL[4:0]

These bits are used to set the current for the backlight current sinks. All enabled backlight current sinks will sink the same current, as shown in Table 1.

Table 1 — Backlight Current Control Bits

| BL_4 | BL_3 | BL_2 | BL_1 | BL_0 | Backlight Current (mA) |
|------|------|------|------|------|------------------------|
| 0 | 0 | 0 | 0 | 0 | 0.5 |
| 0 | 0 | 0 | 0 | 1 | 1.0 |
| 0 | 0 | 0 | 1 | 0 | 1.5 |
| 0 | 0 | 0 | 1 | 1 | 2.0 |
| 0 | 0 | 1 | 0 | 0 | 2.5 |
| 0 | 0 | 1 | 0 | 1 | 3.0 |
| 0 | 0 | 1 | 1 | 0 | 3.5 |
| 0 | 0 | 1 | 1 | 1 | 4.0 |
| 0 | 1 | 0 | 0 | 0 | 4.5 |
| 0 | 1 | 0 | 0 | 1 | 5 |
| 0 | 1 | 0 | 1 | 0 | 5.5 |
| 0 | 1 | 0 | 1 | 1 | 6 |
| 0 | 1 | 1 | 0 | 0 | 6.5 |
| 0 | 1 | 1 | 0 | 1 | 7 |
| 0 | 1 | 1 | 1 | 0 | 7.5 |
| 0 | 1 | 1 | 1 | 1 | 8 |
| 1 | 0 | 0 | 0 | 0 | 8.5 |
| 1 | 0 | 0 | 0 | 1 | 9 |
| 1 | 0 | 0 | 1 | 0 | 9.5 |
| 1 | 0 | 0 | 1 | 1 | 10 |
| 1 | 0 | 1 | 0 | 0 | 10.5 |
| 1 | 0 | 1 | 0 | 1 | 11 |
| 1 | 0 | 1 | 1 | 0 | 11.5 |
| 1 | 0 | 1 | 1 | 1 | 12 |
| 1 | 1 | 0 | 0 | 0 | 13 |
| 1 | 1 | 0 | 0 | 1 | 14 |
| 1 | 1 | 0 | 1 | 0 | 15 |
| 1 | 1 | 0 | 1 | 1 | 17 |
| 1 | 1 | 1 | 0 | 0 | 19 |
| 1 | 1 | 1 | 0 | 1 | 21 |
| 1 | 1 | 1 | 1 | 0 | 23 |
| 1 | 1 | 1 | 1 | 1 | 25 |

BL Enable Control Register (0x01)

This register is used to enable the backlight current sinks.

BLEN[4:1]

These bits are used to enable current sinks (active high, default low).

BLEN_4 — Enable bit for backlight BL4

BLEN_3 — Enable bit for backlight BL3

BLEN_2 — Enable bit for backlight BL2

BLEN_1 — Enable bit for backlight BL1

When enabled, the current sinks will carry the current set by the backlight current control bits BL[4:0], as shown in Table 1.

Flash/Spotlight Control Register (0x02)

This register is used to configure the flash time-out feature, the flash or spotlight current, and select flash or spotlight current ranges.

FLTO

This bit is used to enable the flash safety time-out feature. The default state is enabled with FLTO = 1. If this bit is set, the device will turn off the flash after a nominal period of 1s. Two ways to re-enable the flash function after a safety time-out are:

- Pull the FLEN pin low to re-enable the flash function
- Clear and re-write FL[2:0]

FL[2:0]

These bits are used to set the current for the flash current sink when configured for flash or spotlight by the FL/SPLB bit. Bits FL[2:0] set the flash or spotlight current, as shown in Table 2.

Register and Bit Definitions (continued)
Table 2 — Flash/Spotlight Control Bits

| FL_2 | FL_1 | FL_0 | FL/SPLB | Flash/Spotlight Current (mA) |
|------|------|------|---------|------------------------------|
| 0 | 0 | 0 | 0 | OFF |
| 0 | 0 | 1 | 0 | 50 |
| 0 | 1 | 0 | 0 | 100 |
| 0 | 1 | 1 | 0 | 150 |
| 1 | 0 | 0 | 0 | 200 |
| 1 | 0 | 1 | 0 | 250 |
| 1 | 1 | 0 | 0 | 250 |
| 1 | 1 | 1 | 0 | 250 |
| 0 | 0 | 0 | 1 | OFF |
| 0 | 0 | 1 | 1 | 300 ⁽¹⁾ |
| 0 | 1 | 0 | 1 | 350 ⁽¹⁾ |
| 0 | 1 | 1 | 1 | 400 ⁽¹⁾ |
| 1 | 0 | 0 | 1 | 400 ⁽¹⁾ |
| 1 | 0 | 1 | 1 | 400 ⁽¹⁾ |
| 1 | 1 | 0 | 1 | 400 ⁽¹⁾ |
| 1 | 1 | 1 | 1 | 400 ⁽¹⁾ |

Note:

(1) When on continuously, the device may reach the temperature limit with 300mA and higher.

FL/SPLB

This bit is used to select either the flash or spotlight current ranges. If this bit is set, the FL current sink can be used to drive a flash of maximum duration 500ms and the current range will be the high (flash) current range. If this bit is cleared, the FL current sink can be used to drive a continuous spotlight at a lower current and the current range will be the lower (spotlight) current range, as shown in Table 2.

LDO Control Register (0x03)

This register is used to enable the LDOs and to set their output voltages.

LDO2[2:0]

These bits are used to set the output voltage of LDO2, as shown in Table 3.

Table 3 — LDO2 Control Bits

| LDO2_2 | LDO2_1 | LDO2_0 | LDO2 Output Voltage |
|------------------------------|--------|--------|---------------------|
| 0 | 0 | 0 | OFF |
| 0 | 0 | 1 | 1.8V |
| 0 | 1 | 0 | 1.7V |
| 0 | 1 | 1 | 1.6V |
| 1 | 0 | 0 | 1.5V |
| 101 through 111 are not used | | | OFF |

LDO1[3:0]

These bits set the output voltage of LDO1, as shown in Table 4.

Table 4 — LDO1 Control Bits

| LDO1_3 | LDO1_2 | LDO1_1 | LDO1_0 | LDO1 Output Voltage |
|--------------------------------|--------|--------|--------|---------------------|
| 0 | 0 | 0 | 0 | OFF |
| 0 | 0 | 0 | 1 | 3.3V |
| 0 | 0 | 1 | 0 | 3.2V |
| 0 | 0 | 1 | 1 | 3.1V |
| 0 | 1 | 0 | 0 | 3.0V |
| 0 | 1 | 0 | 1 | 2.9V |
| 0 | 1 | 1 | 0 | 2.8V |
| 0 | 1 | 1 | 1 | 2.7V |
| 1 | 0 | 0 | 0 | 2.6V |
| 1 | 0 | 0 | 1 | 2.5V |
| 1010 through 1111 are not used | | | | OFF |

Serial Interface

The I²C General Specification

The SC621A is a read-write slave-mode I²C device and complies with the Philips I²C standard Version 2.1, dated January 2000. The SC621A has four user-accessible internal 8-bit registers. The I²C interface has been designed for program flexibility, supporting direct format for write operation. Read operations are supported on both combined format and stop separated format. While there is no auto increment/decrement capability in the SC621A I²C logic, a tight software loop can be designed to randomly access the next register independent of which register you begin accessing. The start and stop commands frame the data-packet and the repeat start condition is allowed if necessary.

SC621A Limitations to the I²C Specifications

The SC621A only recognizes seven bit addressing. This means that ten bit addressing and CBUS communication are not compatible. The device can operate in either standard mode (100kbit/s) or fast mode (400kbit/s).

Slave Address Assignment

The seven bit slave address is 0110 111x. The eighth bit is the data direction bit. 0x6E is used for a write operation, and 0x6F is used for a read operation.

Supported Formats

The supported formats are described in the following subsections.

Direct Format — Write

The simplest format for an I²C write is direct format. After the start condition [S], the slave address is sent, followed

by an eighth bit indicating a write. The SC621A I²C then acknowledges that it is being addressed, and the master responds with an 8 bit data byte consisting of the register address. The slave acknowledges and the master sends the appropriate 8 bit data byte. Once again the slave acknowledges and the master terminates the transfer with the stop condition [P].

Combined Format — Read

After the start condition [S], the slave address is sent, followed by an eighth bit indicating a write. The SC621A I²C then acknowledges that it is being addressed, and the master responds with an 8 bit data byte consisting of the register address. The slave acknowledges and the master sends the repeated start condition [Sr]. Once again, the slave address is sent, followed by an eighth bit indicating a read. The slave responds with an acknowledge and the previously addressed 8 bit data byte; the master then sends a non-acknowledge (NACK). Finally, the master terminates the transfer with the stop condition [P].

Stop Separated Reads

Stop-separated reads can also be used. This format allows a master to set up the register address pointer for a read and return to that slave at a later time to read the data. In this format the slave address followed by a write command are sent after a start [S] condition. The SC621A then acknowledges it is being addressed, and the master responds with the 8-bit register address. The master sends a stop or restart condition and may then address another slave. After performing other tasks, the master can send a start or restart condition to the SC621A with a read command. The device acknowledges this request and returns the data from the register location that had previously been set up.

Serial Interface (continued)

I²C Direct Format Write



S – Start Condition
 W – Write = '0'
 A – Acknowledge (sent by slave)
 P – Stop condition

Slave Address – 7-bit
 Register address – 8-bit
 Data – 8-bit

I²C Stop Separated Format Read

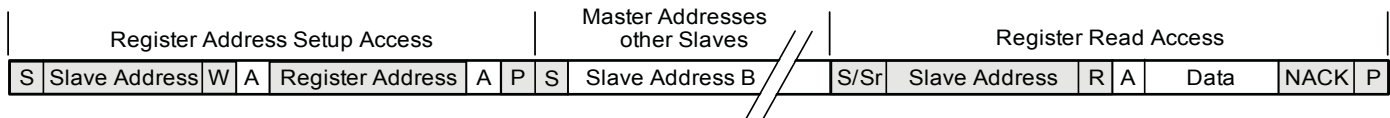

S – Start Condition
 W – Write = '0'
 R – Read = '1'
 A – Acknowledge (sent by slave)
 NAK – Non-Acknowledge (sent by master)
 Sr – Repeated Start condition
 P – Stop condition

Slave Address – 7-bit
 Register address – 8-bit
 Data – 8-bit

I²C Combined Format Read



S – Start Condition
 W – Write = '0'
 R – Read = '1'
 A – Acknowledge (sent by slave)
 NAK – Non-Acknowledge (sent by master)
 Sr – Repeated Start condition
 P – Stop condition

Slave Address – 7-bit
 Register address – 8-bit
 Data – 8-bit

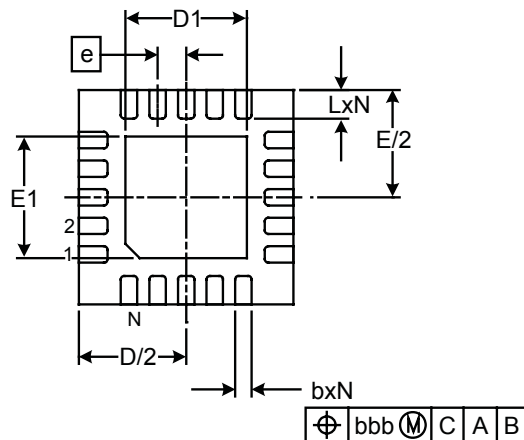
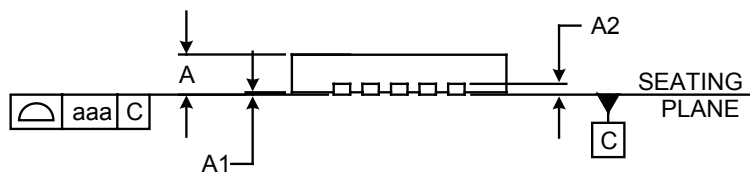
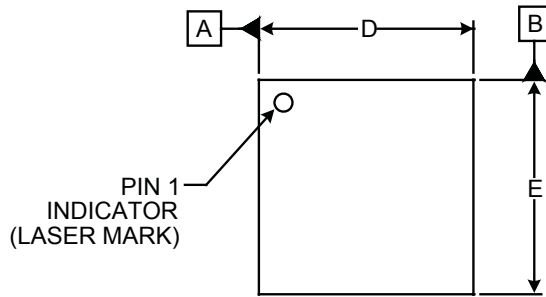
Outline Drawing — MLPQ-UT-20 3x3

| DIM | INCHES | | | MILLIMETERS | | |
|-----|----------|------|------|-------------|------|------|
| | MIN | NOM | MAX | MIN | NOM | MAX |
| A | .020 | - | .024 | 0.50 | - | 0.60 |
| A1 | .000 | - | .002 | 0.00 | - | 0.05 |
| A2 | (.006) | | | (0.1524) | | |
| b | .006 | .008 | .010 | 0.15 | 0.20 | 0.25 |
| D | .114 | .118 | .122 | 2.90 | 3.00 | 3.10 |
| D1 | .061 | .067 | .071 | 1.55 | 1.70 | 1.80 |
| E | .114 | .118 | .122 | 2.90 | 3.00 | 3.10 |
| E1 | .061 | .067 | .071 | 1.55 | 1.70 | 1.80 |
| e | .016 BSC | | | 0.40 BSC | | |
| L | .012 | .016 | .020 | 0.30 | 0.40 | 0.50 |
| N | 20 | | | 20 | | |
| aaa | .003 | | | 0.08 | | |
| bbb | .004 | | | 0.10 | | |

NOTES:

1. CONTROLLING DIMENSIONS ARE IN MILLIMETERS (ANGLES IN DEGREES).
2. COPLANARITY APPLIES TO THE EXPOSED PAD AS WELL AS THE TERMINALS.
3. DAP is 1.90 x 190mm.

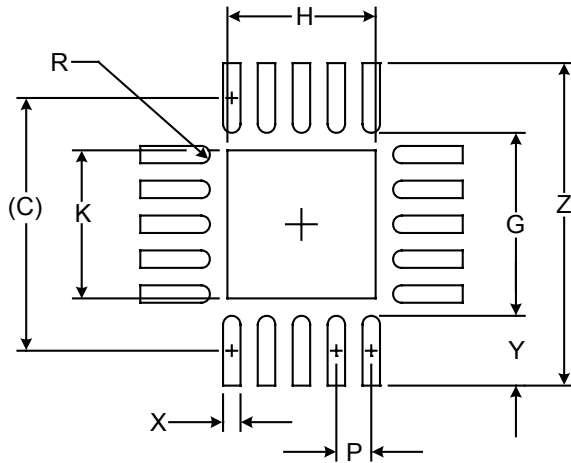
Land Pattern — MLPQ-UT-20 3x3

| DIMENSIONS | | |
|------------|--------|-------------|
| DIM | INCHES | MILLIMETERS |
| C | (.114) | (2.90) |
| G | .083 | 2.10 |
| H | .067 | 1.70 |
| K | .067 | 1.70 |
| P | .016 | 0.40 |
| R | .004 | 0.10 |
| X | .008 | 0.20 |
| Y | .031 | 0.80 |
| Z | .146 | 3.70 |

NOTES:

1. CONTROLLING DIMENSIONS ARE IN MILLIMETERS (ANGLES IN DEGREES).
2. THIS LAND PATTERN IS FOR REFERENCE PURPOSES ONLY. CONSULT YOUR MANUFACTURING GROUP TO ENSURE YOUR COMPANY'S MANUFACTURING GUIDELINES ARE MET.
3. THERMAL VIAS IN THE LAND PATTERN OF THE EXPOSED PAD SHALL BE CONNECTED TO A SYSTEM GROUND PLANE. FAILURE TO DO SO MAY COMPROMISE THE THERMAL AND/OR FUNCTIONAL PERFORMANCE OF THE DEVICE.

Contact Information

Semtech Corporation
 Power Management Products Division
 200 Flynn Road, Camarillo, CA 93012
 Phone: (805) 498-2111 Fax: (805) 498-3804

www.semtech.com

Looking for pricing, stock, or lifecycle information?

Click below to explore more details on WIN SOURCE:

 [View SC621AULTRT on WIN SOURCE](#)

 [Semtech Corporation](#) Information

Optimize Your Supply Chain with WIN SOURCE Solutions

-  Global Sourcing Solution
-  Obsolete Management
-  Cost Control Management
-  Shortage Management
-  Alternative Solution
-  Excess Inventory Management