



THE DATASHEET OF MAX4051CSE+





Low-Voltage, CMOS Analog Multiplexers/Switches

MAX4051/A, MAX4052/A, MAX4053/A

General Description

The MAX4051/MAX4052/MAX4053 and MAX4051A/MAX4052A/MAX4053A are low-voltage, CMOS analog ICs configured as an 8-channel multiplexer (MAX4051/A), two 4-channel multiplexers (MAX4052/A), and three single-pole/double-throw (SPDT) switches (MAX4053/A). The A-suffix parts are fully characterized for on-resistance match, on-resistance flatness, and low leakage.

These CMOS devices can operate continuously with dual power supplies ranging from $\pm 2.7V$ to $\pm 8V$ or a single supply between $+2.7V$ and $+16V$. Each switch can handle rail-to-rail analog signals. The off-leakage current is only $0.1nA$ at $+25^\circ C$ or $5nA$ at $+85^\circ C$ (MAX4051A/MAX4052A/MAX4053A).

All digital inputs have $0.8V$ to $2.4V$ logic thresholds, ensuring TTL/CMOS-logic compatibility when using $\pm 5V$ or a single $+5V$ supply.

Applications

- Battery-Operated Equipment
- Audio and Video Signal Routing
- Low-Voltage Data-Acquisition Systems
- Communications Circuits

Features

- ◆ Pin Compatible with Industry-Standard 74HC4051/74HC4052/74HC4053
- ◆ Guaranteed On-Resistance: 100Ω with $\pm 5V$ Supplies
- ◆ Guaranteed Match Between Channels: 6Ω (MAX4051A–MAX4053A) 12Ω (MAX4051–MAX4053)
- ◆ Guaranteed Low Off-Leakage Currents: $0.1nA$ at $+25^\circ C$ (MAX4051A–MAX4053A) $1nA$ at $+25^\circ C$ (MAX4051–MAX4053)
- ◆ Guaranteed Low On-Leakage Currents: $0.1nA$ at $+25^\circ C$ (MAX4051A–MAX4053A) $1nA$ at $+25^\circ C$ (MAX4051–MAX4053)
- ◆ Single-Supply Operation from $+2.0V$ to $+16V$ Dual-Supply Operation from $\pm 2.7V$ to $\pm 8V$
- ◆ TTL/CMOS-Logic Compatible
- ◆ Low Distortion: $< 0.04\%$ (600Ω)
- ◆ Low Crosstalk: $< -90dB$ (50Ω)
- ◆ High Off-Isolation: $< -90dB$ (50Ω)

Ordering Information

PART	TEMP RANGE	PIN-PACKAGE
MAX4051ACPE	$0^\circ C$ to $+70^\circ C$	16 Plastic DIP
MAX4051ACSE	$0^\circ C$ to $+70^\circ C$	16 Narrow SO
MAX4051ACEE	$0^\circ C$ to $+70^\circ C$	16 QSOP

Ordering Information continued at end of data sheet.

Pin Configurations/Functional Diagrams

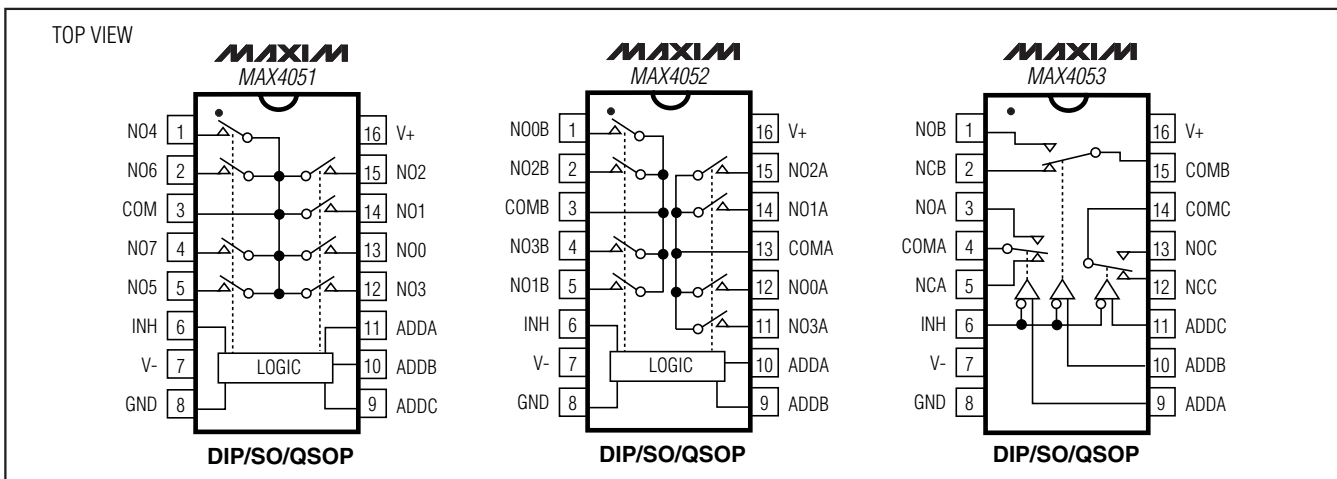

For pricing, delivery, and ordering information, please contact Maxim/Dallas Direct! at 1-888-629-4642, or visit Maxim's website at www.maxim-ic.com.

Low-Voltage, CMOS Analog Multiplexers/Switches

ABSOLUTE MAXIMUM RATINGS

Voltages Referenced to GND

V+	-0.3V to +17V
V-	+0.3V to -17V
V+ to V-	-0.3V to +17V
Voltage into Any Terminal (Note 1)	(V- - 2V) to (V+ + 2V) or 30mA (whichever occurs first)

Continuous Current into Any Terminal.....±30mA

Peak Current, NO or COM

(pulsed at 1ms, 10% duty cycle).....±100mA

Continuous Power Dissipation (T_A = +70°C)

Plastic DIP (derate 10.53mW/°C above +70°C).....	842mW
Narrow SO (derate 8.70mW/°C above +70°C).....	696mW
QSOP (derate 8.00mW/°C above +70°C).....	640mW
CERDIP (derate 10.00mW/°C above +70°C).....	800mW

Operating Temperature Ranges

MAX405_C_E/MAX405_AC_E.....0°C to +70°C

MAX405_E_E/MAX405_AE_E.....-40°C to +85°C

MAX405_MJE/MAX405_AMJE.....-55°C to +125°C

Storage Temperature Range.....-65°C to +150°C

Lead Temperature (soldering, 10s).....+300°C

Note 1: Signals on any terminal exceeding V+ or V- are clamped by internal diodes. Limit forward-diode current to maximum current rating.

Stresses beyond those listed under "Absolute Maximum Ratings" may cause permanent damage to the device. These are stress ratings only, and functional operation of the device at these or any other conditions beyond those indicated in the operational sections of the specifications is not implied. Exposure to absolute maximum rating conditions for extended periods may affect device reliability.

ELECTRICAL CHARACTERISTICS—Dual Supplies

(V+ = +4.5V to +5.5V, V- = -4.5V to -5.5V, T_A = T_{MIN} to T_{MAX}, unless otherwise noted. Typical values are at T_A = +25°C.)

PARAMETER	SYMBOL	CONDITIONS		MIN	TYP (Note 2)	MAX	UNITS		
ANALOG SWITCH									
Analog Signal Range	V _{COM} , V _{NO}			C, E, M	V-	V+	V		
COM-NO On-Resistance	R _{ON}	V+ = 5V, V- = -5V, I _{NO} = 1mA, V _{COM} = ±3V		TA = +25°C	60	100	Ω		
				C, E, M		125			
COM-NO On-Resistance Match Between Channels (Note 3)	ΔR _{ON}	V+ = 5V, V- = -5V, I _{NO} = 1mA, V _{COM} = ±3V		MAX4051A, MAX4052A, MAX4053A	TA = +25°C	6	Ω		
				C, E, M		12			
				MAX4051, MAX4052, MAX4053	TA = +25°C	12			
COM-NO On-Resistance Flatness (Note 4)	R _{FLAT(ON)}	V+ = 5V, V- = -5V, I _{NO} = 1mA, V _{COM} = -3V, 0V, 3V		MAX4051A, MAX4052A, MAX4053A	TA = +25°C	10	Ω		
				C, E, M		15			
NO Off-Leakage Current (Note 5)	I _{NO(OFF)}	V+ = 5.5V, V- = -5.5V, V _{NO} = 4.5V, V _{COM} = -4.5V		MAX4051, MAX4052, MAX4053	TA = +25°C	-1	0.002	1	nA
				C, E		-10	10		
				M		-100	100		
		V+ = 5.5V, V- = -5.5V, V _{NO} = -4.5V, V _{COM} = 4.5V		MAX4051A, MAX4052A, MAX4053A	TA = +25°C	-0.1	0.002	0.1	
				C, E		-5	5		
				M		-100	100		

Low-Voltage, CMOS Analog Multiplexers/Switches

MAX4051/A, MAX4052/A, MAX4053/A

ELECTRICAL CHARACTERISTICS—Dual Supplies (continued)

(V+ = +4.5V to +5.5V, V- = -4.5V to -5.5V, TA = TMIN to TMAX, unless otherwise noted. Typical values are at TA = +25°C.)

PARAMETER	SYMBOL	CONDITIONS			MIN	TYP (Note 2)	MAX	UNITS
COM Off-Leakage Current (Note 5)	ICOM(OFF)	V+ = 5.5V, V- = -5.5V, VNO = 4.5V, VCOM = -4.5V	MAX4051A	TA = +25°C	-0.1	0.002	0.1	nA
				C, E	-5		5	
				M	-100		100	
			MAX4051	TA = +25°C	-1	0.002	1	
				C, E	-10		10	
				M	-100		100	
			MAX4052A, MAX4053A	TA = +25°C	-0.1	0.002	0.1	
				C, E	-2.5		2.5	
				M	-100		100	
		MAX4052, MAX4053	TA = +25°C	-1	0.002	1		
			C, E	-5		5		
			M	-50		50		
		V+ = 5.5V, V- = -5.5V, VNO = -4.5V, VCOM = 4.5V	MAX4051A	TA = +25°C	-0.1	0.002	0.1	
				C, E	-5		5	
				M	-100		100	
			MAX4051	TA = +25°C	-1	0.002	1	
				C, E	-10		10	
				M	-100		100	
MAX4052A, MAX4053A	TA = +25°C		-0.1	0.002	0.1			
	C, E		-2.5		2.5			
	M		-50		50			
MAX4052, MAX4053	TA = +25°C	-1	0.002	1				
	C, E	-5		5				
	M	-50		50				
COM On-Leakage Current (Note 5)	ICOM(ON)	V+ = 5.5V, V- = -5.5V, VCOM = VNO = ±4.5V	MAX4051A	TA = +25°C	-0.1	0.002	0.1	nA
				C, E	-5		5	
				M	-100		100	
			MAX4051	TA = +25°C	-1	0.002	1	
				C, E	-10		10	
				M	-100		100	
			MAX4052A, MAX4053A	TA = +25°C	-0.1	0.002	0.1	
				C, E	-2.5		2.5	
				M	-50		50	
			MAX4052, MAX4053	TA = +25°C	-1	0.002	1	
				C, E	-5		5	
				M	-50		50	

Low-Voltage, CMOS Analog Multiplexers/Switches

ELECTRICAL CHARACTERISTICS—Dual Supplies (continued)

(V+ = +4.5V to +5.5V, V- = -4.5V to -5.5V, TA = TMIN to TMAX, unless otherwise noted. Typical values are at TA = +25°C.)

PARAMETER	SYMBOL	CONDITIONS	MIN	TYP (Note 2)	MAX	UNITS	
DIGITAL I/O							
ADD, INH Input Logic Threshold High	V _{IH}		C, E, M	2.4		V	
ADD, INH Input Logic Threshold Low	V _{IL}		C, E, M		0.8	V	
ADD, INH Input Current Logic High or Low	I _{IH} , I _{IL}	V _{ADD} , V _{INH} = V+, 0V	C, E, M	-1	0.03	1	μA
SWITCH DYNAMIC CHARACTERISTICS							
Turn-On Time (Note 6)	t _{ON}	Figure 3	TA = +25°C	50	175	ns	
			C, E, M		225		
Turn-Off Time (Note 6)	t _{OFF}	Figure 3	TA = +25°C	40	150	ns	
			C, E, M		200		
Transition Time	t _{TRANS}	Figure 2	TA = +25°C	75	250	ns	
Break-Before-Make Delay	t _{OPEN}	Figure 4	TA = +25°C	2	10	ns	
Charge Injection (Note 6)	Q	C _L = 1nF, R _S = 0Ω, V _{NO} = 0V, Figure 5	TA = +25°C	2	10	pC	
NO Off-Capacitance	C _{NO(OFF)}	V _{NO} = GND, f = 1MHz, Figure 7	TA = +25°C	2		pF	
COM Off-Capacitance	C _{COM(OFF)}	V _{COM} = GND, f = 1MHz, Figure 7	TA = +25°C	2		pF	
Switch On-Capacitance	C _(ON)	V _{COM} = V _{NO} = GND, f = 1MHz, Figure 7	TA = +25°C	8		pF	
Off-Isolation	V _{ISO}	C _L = 15pF, R _L = 50Ω, f = 100kHz, V _{NO} = 1V _{RMS} , Figure 6	TA = +25°C	<-90		dB	
Channel-to-Channel Crosstalk	V _{CT}	C _L = 15pF, R _L = 50Ω, f = 100kHz, V _{NO} = 1V _{RMS} , Figure 6	TA = +25°C	<-90		dB	
POWER SUPPLY							
Power-Supply Range	V+, V-		C, E, M	±2.7	±8	V	
V+ Supply Current	I+	INH = ADD = 0V or V+	TA = +25°C	-1	0.1	1	μA
			C, E, M			10	
V- Supply Current	I-	INH = ADD = 0V or V+	TA = +25°C	-1	0.1	1	μA
			C, E, M			-10	

Note 2: The algebraic convention is used in this data sheet; the most negative value is shown in the minimum column.

Note 3: $\Delta R_{ON} = R_{ON(MAX)} - R_{ON(MIN)}$.

Note 4: Flatness is defined as the difference between the maximum and minimum value of on-resistance as measured over the specified analog signal ranges; i.e., V_{NO} = 3V to 0V and 0V to -3V.

Note 5: Leakage parameters are 100% tested at maximum-rated hot operating temperature, and guaranteed by correlation at TA = +25°C.

Note 6: Guaranteed by design, not production tested.

Low-Voltage, CMOS Analog Multiplexers/Switches

ELECTRICAL CHARACTERISTICS—Single +5V Supply

(V+ = +4.5V to +5.5V, V- = 0V, TA = TMIN to TMAX, unless otherwise noted. Typical values are at TA = +25°C.)

PARAMETER	SYMBOL	CONDITIONS		MIN	TYP (Note 2)	MAX	UNITS				
ANALOG SWITCH											
Analog Signal Range	VCOM, VNO		C, E, M	V-		V+	V				
COM-NO On-Resistance	RON	V+ = 5V, INO = 1mA, VCOM = 3.5V	TA = +25°C		125	225	Ω				
			C, E, M			280					
NO Off-Leakage Current (Note 5)	INO(OFF)	V+ = 5.5V, VNO = 4.5V, VCOM = 0V	TA = +25°C	-1	0.002	1	nA				
			C, E		-10	10					
			M		-100	100					
		V+ = 5.5V, VNO = 0V, VCOM = 4.5V	TA = +25°C	-1	0.002	1					
			C, E		-10	10					
			M		-100	100					
COM Off-Leakage Current (Note 5)	ICOM(OFF)	V+ = 5.5V, VNO = 4.5V, VCOM = 0V	MAX4051/A	TA = +25°C	-1	0.002	1	nA			
				C, E		-10	10				
				M		-100	100				
			MAX4052/A, MAX4053/A	TA = +25°C	-1	0.002	1				
				C, E		-5	5				
				M		-50	50				
		V+ = 5.5V, VNO = 0V, VCOM = 4.5V or 0V	MAX4051/A	TA = +25°C	-1	0.002	1				
				C, E		-10	10				
				M		-100	100				
			MAX4052/A, MAX4053/A	TA = +25°C	-1	0.002	1				
				C, E		-5	5				
				M		-50	50				
COM On-Leakage Current (Note 5)	ICOM(ON)	V+ = 5.5V, VCOM = VNO = 4.5V	MAX4051/A	TA = +25°C	-1	0.002	1	nA			
				C, E		-10	10				
				M		-100	100				
			MAX4052/A, MAX4053/A	TA = +25°C	-1	0.002	1				
				C, E		-10	10				
				M		-100	100				
			DIGITAL I/O								
			ADD, INH Input Logic Threshold High	VIH		C, E, M	2.4				V
ADD, INH Input Logic Threshold Low	VIL		C, E, M			0.8	V				
ADD, INH Input Current Logic High or Low	IiH, IiL	VADD, VINH = V+, 0V	C, E, M	-1	0.03	1	μA				
POWER SUPPLY											
V+ Supply Current	I+	INH = ADD = 0V or V+	TA = +25°C	-1		1	μA				
			C, E, M			10					

MAX4051/A, MAX4052/A, MAX4053/A

Low-Voltage, CMOS Analog Multiplexers/Switches

ELECTRICAL CHARACTERISTICS—Single +5V Supply (continued)

(V+ = +4.5V to +5.5V, V- = 0V, T_A = T_{MIN} to T_{MAX}, unless otherwise noted. Typical values are at T_A = +25°C.)

PARAMETER	SYMBOL	CONDITIONS	MIN	TYP (Note 2)	MAX	UNITS
SWITCH DYNAMIC CHARACTERISTICS						
Turn-On Time (Note 6)	t _{ON}	Figure 3	T _A = +25°C	90	200	ns
			C, E, M		275	
Turn-Off Time (Note 6)	t _{OFF}	Figure 3	T _A = +25°C	60	125	ns
			C, E, M		175	
Break-Before-Make Delay	t _{OPEN}	Figure 4	T _A = +25°C	30		ns
Charge Injection (Note 6)	Q	C _L = 1nF, R _S = 0Ω, V _{NO} = 0V, Figure 5	T _A = +25°C	2	10	pC
Off-Isolation	V _{ISO}	C _L = 15pF, R _L = 50Ω, f = 100kHz, V _{NO} = 1V _{RMS} , Figure 6	T _A = +25°C	<-90		dB
Channel-to-Channel Crosstalk	V _{CT}	C _L = 15pF, R _L = 50Ω, f = 100kHz, V _{NO} = 1V _{RMS} , Figure 6	T _A = +25°C	<-90		dB

Note 2: The algebraic convention is used in this data sheet; the most negative value is shown in the minimum column.

Note 3: $\Delta R_{ON} = R_{ON(MAX)} - R_{ON(MIN)}$.

Note 4: Flatness is defined as the difference between the maximum and minimum value of on-resistance as measured over the specified analog signal ranges; i.e., V_{NO} = 3V to 0V and 0V to -3V.

Note 5: Leakage parameters are 100% tested at maximum-rated hot operating temperature, and guaranteed by correlation at T_A = +25°C.

Note 6: Guaranteed by design, not production tested.

Low-Voltage, CMOS Analog Multiplexers/Switches

ELECTRICAL CHARACTERISTICS—Single +3V Supply

(V+ = +3.0V to +3.6V, V- = 0V, TA = TMIN to TMAX, unless otherwise noted. Typical values are at TA = +25°C.)

PARAMETER	SYMBOL	CONDITIONS		MIN	TYP (Note 2)	MAX	UNITS			
ANALOG SWITCH										
Analog Signal Range	VCOM, VNO		C, E, M	V-		V+	V			
COM-NO On-Resistance	RON	INO = 1mA, V+ = 3V, VCOM = 1.5V	TA = +25°C		250	525	Ω			
			C, E, M			700				
NO Off-Leakage Current (Note 5)	INO(OFF)	V+ = 3.6V, VNO = 3V, VCOM = 0V	TA = +25°C	-1	0.002	1	nA			
			C, E	-10		10				
			M	-100		100				
		V+ = 3.6V, VNO = 0V, VCOM = 3V	TA = +25°C	-1	0.002	1				
			C, E	-10		10				
			M	-100		100				
COM Off-Leakage Current (Note 5)	ICOM(OFF)	V+ = 3.6V, VNO = 3V, VCOM = 0V	MAX4051/A	TA = +25°C	-1	0.002	1	nA		
				C, E	-10		10			
				M	-100		100			
			MAX4052/A, MAX4053/A	TA = +25°C	-1	0.002	1			
				C, E	-5		5			
				M	-50		50			
		V+ = 3.6V, VNO = 0V, VCOM = 3V	MAX4051/A	TA = +25°C	-1	0.002	1			
				C, E	-10		10			
				M	-100		100			
			MAX4052/A, MAX4053/A	TA = +25°C	-1	0.002	1			
				C, E	-5		5			
				M	-50		50			
COM On-Leakage Current (Note 5)	ICOM(ON)	V+ = 3.6V, VCOM = VNO = 3V	MAX4051/A	TA = +25°C	-1	0.002	1	nA		
				C, E	-10		10			
				M	-100		100			
			MAX4052/A, MAX4053/A	TA = +25°C	-1	0.002	1			
		C, E		-10		10				
		M		-100		100				
		DIGITAL I/O								
		ADD, INH Input Logic Threshold High	VIH		C, E, M	2.4				V
ADD, INH Input Logic Threshold Low	VIL		C, E, M			0.8	V			
ADD, INH Input Current Logic High or Low	IiH, IiL	VADD, VINH = V+, 0V	C, E, M	-1	0.03	1	μA			
POWER SUPPLY										
V+ Supply Current	I+	INH = ADD = 0V or V+	TA = +25°C	-1		1	μA			
			C, E, M			10				

MAX4051/A, MAX4052/A, MAX4053/A

Low-Voltage, CMOS Analog Multiplexers/Switches

ELECTRICAL CHARACTERISTICS—Single +3V Supply (continued)

(V+ = +3.0V to +3.6V, V- = 0V, TA = TMIN to TMAX, unless otherwise noted. Typical values are at TA = +25°C.)

PARAMETER	SYMBOL	CONDITIONS	MIN	TYP (Note 2)	MAX	UNITS
SWITCH DYNAMIC CHARACTERISTICS						
Turn-On Time (Note 6)	tON	Figure 3	TA = +25°C	180	600	ns
			C, E, M		700	
Turn-Off Time (Note 6)	tOFF	Figure 3	TA = +25°C	100	300	ns
			C, E, M		400	
Break-Before-Make Delay	tOPEN	Figure 4	TA = +25°C	90		ns
Charge Injection (Note 6)	Q	CL = 1nF, RS = 0Ω, VNO = 0V, Figure 5	TA = +25°C	1	10	pC
Off-Isolation	VISO	CL = 15pF, RL = 50Ω, f = 100kHz, VNO = 1VRMS, Figure 6	TA = +25°C	<-90		dB
Channel-to-Channel Crosstalk	VCT	CL = 15pF, RL = 50Ω, f = 100kHz, VNO = 1VRMS, Figure 6	TA = +25°C	<-90		dB

Note 2: The algebraic convention is used in this data sheet; the most negative value is shown in the minimum column.

Note 3: $\Delta R_{ON} = R_{ON(MAX)} - R_{ON(MIN)}$.

Note 4: Flatness is defined as the difference between the maximum and minimum value of on-resistance as measured over the specified analog signal ranges; i.e., VNO = 3V to 0V and 0V to -3V.

Note 5: Leakage parameters are 100% tested at maximum-rated hot operating temperature, and guaranteed by correlation at TA = +25°C.

Note 6: Guaranteed by design, not production tested.

Low-Voltage, CMOS Analog Multiplexers/Switches

Typical Operating Characteristics

($V_+ = +5V$, $V_- = -5V$, GND = 0V, $T_A = +25^\circ C$, unless otherwise noted.)

MAX4051/A, MAX4052/A, MAX4053/A

ON-RESISTANCE vs. V_{COM} (DUAL SUPPLIES)

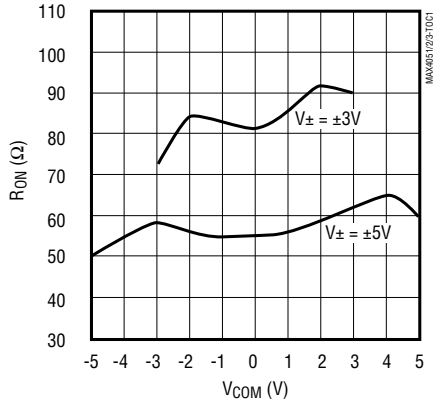

ON-RESISTANCE vs. V_{COM} AND TEMPERATURE (DUAL SUPPLIES)

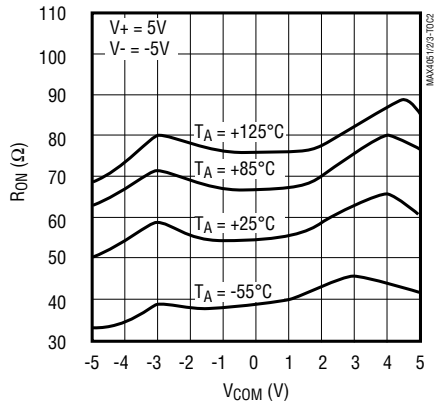

ON-RESISTANCE vs. V_{COM} (SINGLE SUPPLY)

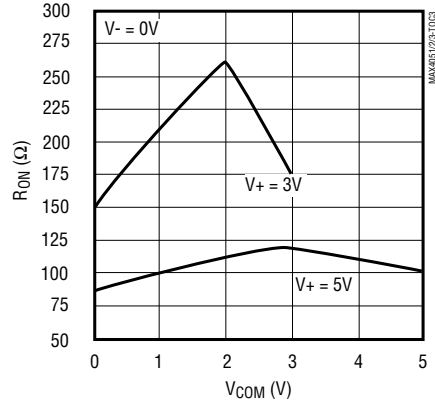

ON-RESISTANCE vs. V_{COM} AND TEMPERATURE (SINGLE SUPPLY)

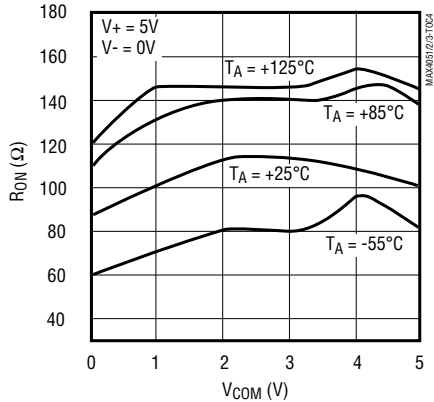

OFF-LEAKAGE vs. TEMPERATURE

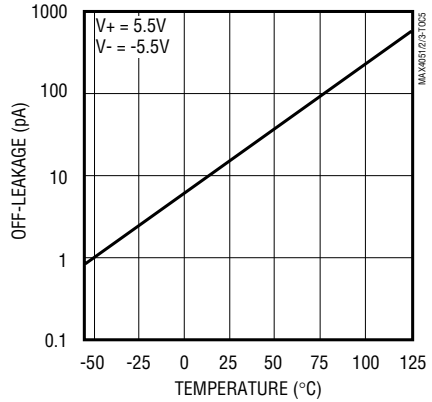

ON-LEAKAGE vs. TEMPERATURE

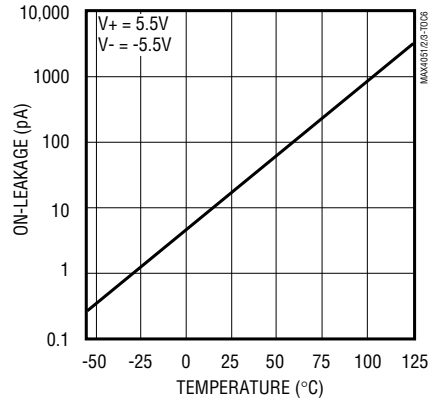

CHARGE INJECTION vs. V_{COM}

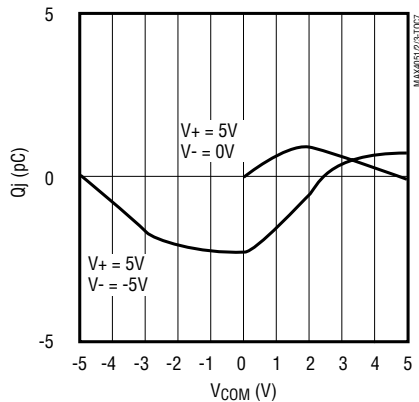

SUPPLY CURRENT vs. TEMPERATURE

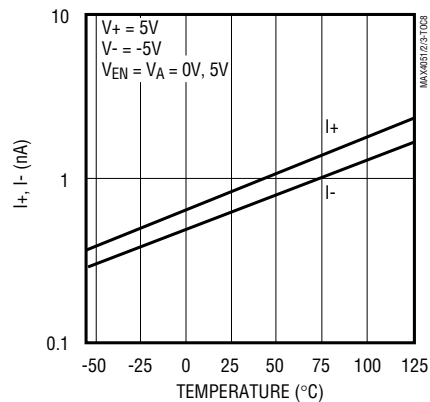

Low-Voltage, CMOS Analog Multiplexers/Switches

Typical Operating Characteristics (continued)

(V+ = +5V, V- = -5V, GND = 0V, TA = +25°C, unless otherwise noted.)



Pin Descriptions

PIN			NAME	FUNCTION
MAX4051/ MAX4051A	MAX4052/ MAX4052A	MAX4053/ MAX4053A		
1, 2, 4, 5, 12, 13, 14, 15	—	—	NO0–NO7	Analog Switch Inputs 0–7
3	—	—	COM	Analog Switch Common
—	1, 2, 4, 5	—	NO0B–NO3B	Analog Switch “B” Inputs 0–3
—	3	15	COMB	Analog Switch “B” Common
—	—	1	NOB	Analog Switch “B” Normally Open Input
—	—	2	NCB	Analog Switch “B” Normally Closed Input
—	—	3	NOA	Analog Switch “A” Normally Open Input
—	—	5	NCA	Analog Switch “A” Normally Closed Input
6	6	6	INH	Digital Inhibit Input. Normally connect to GND. Can be driven to logic high to set all switches off.
7	7	7	V-	Negative Analog Supply Voltage Input. Connect to GND for single-supply operation.
8	8	8	GND	Ground. Connect to digital ground. (Analog signals have no ground reference; they are limited to V+ and V-.)
9	—	11	ADDC	Digital Address “C” Input
10	9	10	ADDB	Digital Address “B” Input
11	10	9	ADDA	Digital Address “A” Input
—	11, 12, 14, 15	—	NO0A–NO3A	Analog Switch “A” Inputs 0–3
—	13	4	COMA	Analog Switch “A” Common
—	—	12	NCC	Analog Switch “C” Normally Closed Input
—	—	13	NOC	Analog Switch “C” Normally Open Input
—	—	14	COMC	Analog Switch “C” Common
16	16	16	V+	Positive Analog and Digital Supply Voltage Input

Note: NO, NC, and COM pins are identical and interchangeable. Any may be considered an input or output; signals pass equally well in both directions.

Low-Voltage, CMOS Analog Multiplexers/Switches

MAX4051/A, MAX4052/A, MAX4053/A

Table 1. Truth Table/Switch Programming

INH	ADDRESS BITS			ON SWITCHES		
	ADDC*	ADDB	ADDA	MAX4051/ MAX4051A	MAX4052/ MAX4052A	MAX4053/ MAX4053A
1	X	X	X	All switches open	All switches open	All switches open
0	0	0	0	COM-NO0	COMB-NO0B, COMA-NO0A	COMA-NCA, COMB-NCB, COMC-NCC
0	0	0	1	COM-NO1	COMB-NO1B, COMA-NO1A	COMA-NOA, COMB-NCB, COMC-NCC
0	0	1	0	COM-NO2	COMB-NO2B, COMA-NO2A	COMA-NCA, COMB-NOB, COMC-NCC
0	0	1	1	COM-NO3	COMB-NO3B, COMA-NO3A	COMA-NOA, COMB-NOB, COMC-NCC
0	1	0	0	COM-NO4	COMB-NO0B, COMA-NO0A	COMA-NCA, COMB-NCB, COMC-NOC
0	1	0	1	COM-NO5	COMB-NO1B, COMA-NO1A	COMA-NOA, COMB-NCB, COMC-NOC
0	1	1	0	COM-NO6	COMB-NO2B, COMA-NO2A	COMA-NCA, COMB-NOB, COMC-NOC
0	1	1	1	COM-NO7	COMB-NO3B, COMA-NO3A	COMA-NOA, COMB-NOB, COMC-NOC

X = Don't care * ADDC not present on MAX4052.

Note: NO and COM pins are identical and interchangeable. Either may be considered an input or output; signals pass equally well in either direction.

Applications Information

Power-Supply Considerations

Overview

The MAX4051/MAX4052/MAX4053 and MAX4051A/MAX4052A/MAX4053A construction is typical of most CMOS analog switches. They have three supply pins: V+, V-, and GND. V+ and V- are used to drive the internal CMOS switches and set the limits of the analog voltage on any switch. Reverse ESD-protection diodes are internally connected between each analog signal pin and both V+ and V-. If any analog signal exceeds V+ or V-, one of these diodes will conduct. During normal operation, these (and other) reverse-biased ESD diodes leak, forming the only current drawn from V+ or V-.

Virtually all the analog leakage current comes from the ESD diodes. Although the ESD diodes on a given signal pin are identical, and therefore fairly well balanced, they are reverse biased differently. Each is biased by either V+ or V- and the analog signal. This means their leakages will vary as the signal varies. The *difference* in the two diode leakages to the V+ and V- pins constitutes the analog signal path leakage current. All analog leakage current flows between each pin and one of the supply terminals, not to the other switch terminal. This is why both sides of a given switch can show leakage currents of either the same or opposite polarity.

There is no connection between the analog signal paths and GND.

Low-Voltage, CMOS Analog Multiplexers/Switches

V+ and GND power the internal logic and logic-level translators, and set both the input and output logic limits. The logic-level translators convert the logic levels into switched V+ and V- signals to drive the gates of the analog signals. This drive signal is the only connection between the logic supplies (and signals) and the analog supplies. V+ and V- have ESD-protection diodes to GND.

The logic-level thresholds are TTL/CMOS compatible when V+ is +5V. As V+ rises, the threshold increases slightly, so when V+ reaches +12V, the threshold is about 3.1V; above the TTL-guaranteed high-level minimum of 2.8V, but still compatible with CMOS outputs.

Bipolar Supplies

These devices operate with bipolar supplies between $\pm 3.0\text{V}$ and $\pm 8\text{V}$. The V+ and V- supplies need not be symmetrical, but their sum cannot exceed the absolute maximum rating of +17V.

Single Supply

These devices operate from a single supply between +3V and +16V when V- is connected to GND. All of the bipolar precautions must be observed. At room temperature, they actually “work” with a single supply at near or below +1.7V, although as supply voltage decreases, switch on-resistance and switching times become very high.

Overvoltage Protection

Proper power-supply sequencing is recommended for all CMOS devices. Do not exceed the absolute maximum ratings, because stresses beyond the listed ratings can cause permanent damage to the devices. Always sequence V+ on first, then V-, followed by the logic inputs (NO) and by COM. If power-supply sequencing is not possible, add two small signal diodes (D1, D2) in series with the supply pins for overvoltage protection (Figure 1).

Adding diodes reduces the analog signal range to one diode drop below V+ and one diode drop above V-, but does not affect the devices' low switch resistance and low leakage characteristics. Device operation is unchanged, and the difference between V+ and V- should not exceed 17V. These protection diodes are not recommended when using a single supply if signal levels must extend to ground.



Figure 1. Overvoltage Protection Using External Blocking Diodes

High-Frequency Performance

In 50Ω systems, signal response is reasonably flat up to 50MHz (see *Typical Operating Characteristics*). Above 20MHz, the on response has several minor peaks which are highly layout dependent. The problem is not turning the switch on, but turning it off. The off-state switch acts like a capacitor, and passes higher frequencies with less attenuation. At 10MHz, off isolation is about -45dB in 50Ω systems, becoming worse (approximately 20dB per decade) as frequency increases. Higher circuit impedances also make off isolation worse. Adjacent channel attenuation is about 3dB above that of a bare IC socket, and is entirely due to capacitive coupling.

Low-Voltage, CMOS Analog Multiplexers/Switches

Test Circuits/Timing Diagrams

MAX4051/A, MAX4052/A, MAX4053/A



Figure 2. Address Transition Time

Low-Voltage, CMOS Analog Multiplexers/Switches



V- = 0V FOR SINGLE-SUPPLY OPERATION.
REPEAT TEST FOR EACH SECTION.

Figure 3. Enable Switching Time

Low-Voltage, CMOS Analog Multiplexers/Switches

MAX4051/A, MAX4052/A, MAX4053/A



Figure 4. Break-Before-Make Interval



Figure 5. Charge Injection

Low-Voltage, CMOS Analog Multiplexers/Switches



Figure 6. Off-Isolation, On-Loss, and Crosstalk



Figure 7. NO/COM Capacitance

Low-Voltage, CMOS Analog Multiplexers/Switches

Package Information

(The package drawing(s) in this data sheet may not reflect the most current specifications. For the latest package outline information, go to www.maxim-ic.com/packages.)



PDIPNLEPS



PACKAGE FAMILY OUTLINE: PDIP .300" 1/1

21-0043 D
DOCUMENT CONTROL NUMBER REV

Low-Voltage, CMOS Analog Multiplexers/Switches

Package Information (continued)

(The package drawing(s) in this data sheet may not reflect the most current specifications. For the latest package outline information, go to www.maxim-ic.com/packages.)

MAX4051/A, MAX4052/A, MAX4053/A



Maxim cannot assume responsibility for use of any circuitry other than circuitry entirely embodied in a Maxim product. No circuit patent licenses are implied. Maxim reserves the right to change the circuitry and specifications without notice at any time.

Maxim Integrated Products, 120 San Gabriel Drive, Sunnyvale, CA 94086 (408) 737-7600 _____ 19

Looking for pricing, stock, or lifecycle information?

Click below to explore more details on WIN SOURCE:

- ⊖ [View MAX4051CSE+](#) on WIN SOURCE
- ⊖ [Maxim Integrated](#) Information

Optimize Your Supply Chain with WIN SOURCE Solutions

- ✓ Global Sourcing Solution
- ✓ Obsolete Management
- ✓ Cost Control Management
- ✓ Shortage Management
- ✓ Alternative Solution
- ✓ Excess Inventory Management