



**THE DATASHEET OF
CPDVR085V0C-HF**



CPDVR085V0C-HF

RoHS Device
Halogen Free



Features

- Bi-directional ESD protection.
- Operating voltage: 5V.

Mechanical data

- Case: SOT-383F standard package, molded plastic.
- Terminals: Gold plated, solderable per MIL-STD-750D, method 2026.
- Marking code: E05
- Mounting position: Any.

Circuit Diagram

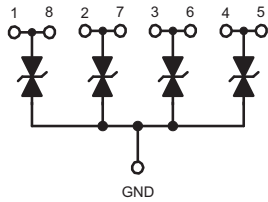

Package

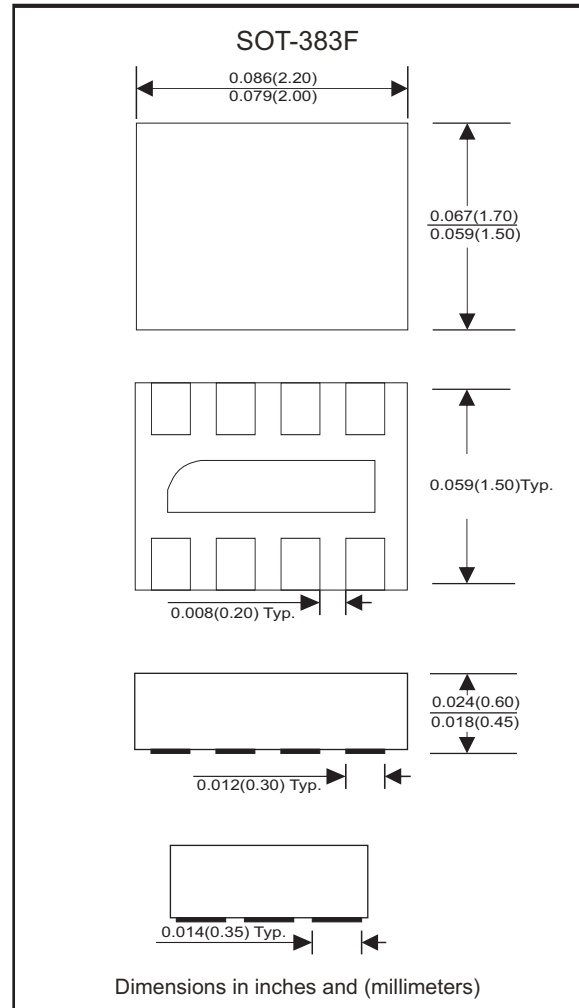
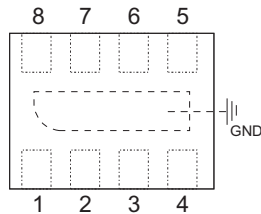

Electrical Characteristics (at TA=25 °C unless otherwise noted)

Parameter	Conditions	Symbol	Min	Typ	Max	Unit
Diode breakdown voltage	IR = 1mA	V _{BD}	6.1	7.0		V
Leakage current	V _R = 5V	I _L		0.1	2.0	uA
Junction capacitance	V _R = 0V, f = 1MHz	C _T		25	30	pF
ESD capability	IEC 61000-4-2(air) IEC 61000-4-2(contact)	ESD			16 8	kV
Operation temperature		T _j			125	°C
Storage temperature		T _{STG}	-55		150	°C

RATING AND CHARACTERISTIC CURVES (CPDVR085V0C-HF)

Fig. 1 - Reverse characteristics

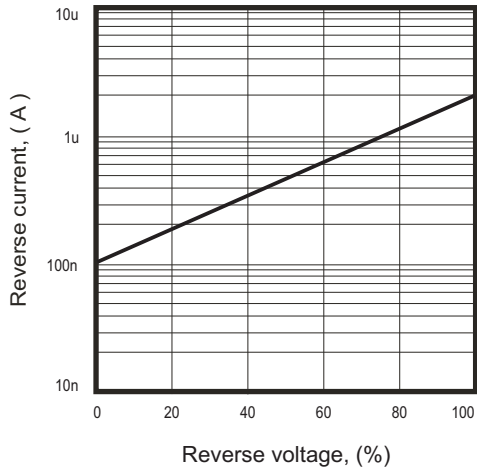

Fig. 2 - Capacitance between terminals characteristics

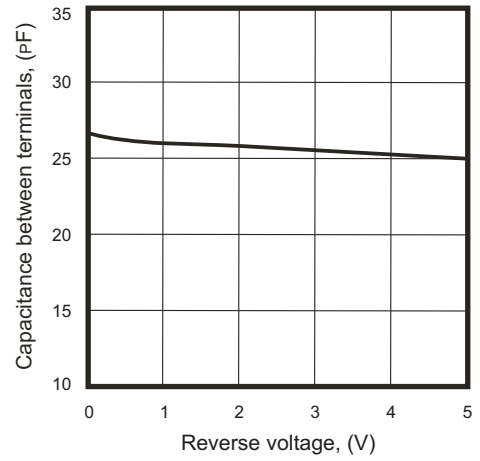
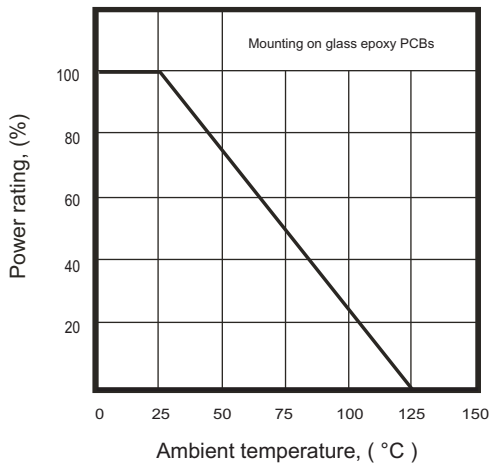
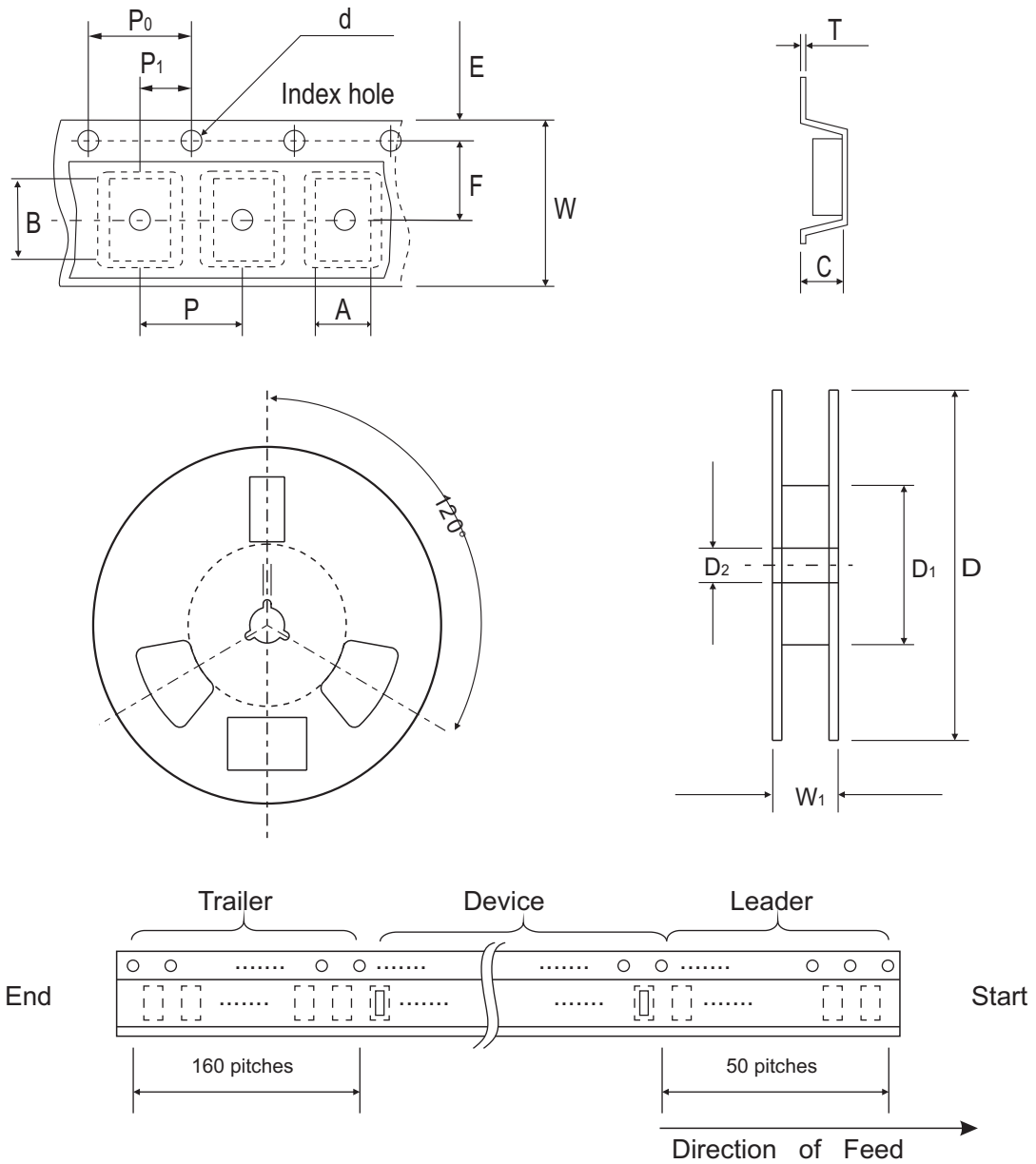

Fig. 3 - Power rating derating curve



Reel Taping Specification



SOT-383F	SYMBOL	A	B	C	d	D	D ₁	D ₂
	(mm)	1.96 ± 0.10	2.31 ± 0.10	0.74 ± 0.10	1.55 ± 0.10	178 ± 1	60.0 MIN.	13.0 ± 0.20
	(inch)	0.077 ± 0.004	0.091 ± 0.004	0.029 ± 0.004	0.061 ± 0.004	7.008 ± 0.04	2.362 MIN.	0.512 ± 0.008

SOT-383F	SYMBOL	E	F	P	P ₀	P ₁	T	W	W ₁
	(mm)	1.75 ± 0.10	3.50 ± 0.05	4.00 ± 0.10	4.00 ± 0.10	2.00 ± 0.10	0.22 ± 0.05	8.00 ± 0.20	13.5 MAX.
	(inch)	0.069 ± 0.004	0.138 ± 0.002	0.157 ± 0.004	0.157 ± 0.004	0.079 ± 0.004	0.009 ± 0.002	0.315 ± 0.008	0.531 MAX.

Marking Code

Part Number	Marking Code
CPDVR085V0C-HF	E05



Suggested PAD Layout

SIZE	SOT-383F	
	(mm)	(inch)
A	0.630	0.025
B	0.300	0.012
C	0.500	0.020
D	0.450	0.018
E	2.150	0.085
F	1.800	0.071

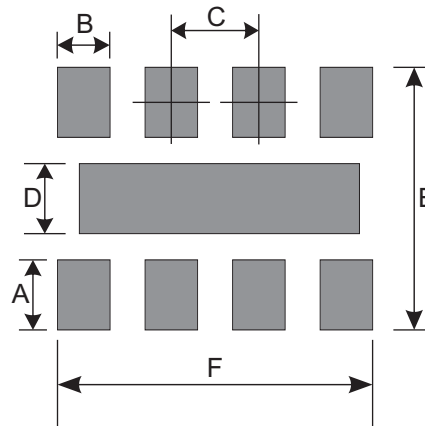

Standard Packaging

Case Type	Qty Per Reel	Reel Size
	(Pcs)	(inch)
SOT-383F	3,000	7

Looking for pricing, stock, or lifecycle information?

Click below to explore more details on WIN SOURCE:

- ⊖ [View CPDVR085V0C-HF on WIN SOURCE](#)
- ⊖ [Comchip Technology Information](#)

Optimize Your Supply Chain with WIN SOURCE Solutions

- ✓ Global Sourcing Solution
- ✓ Obsolete Management
- ✓ Cost Control Management
- ✓ Shortage Management
- ✓ Alternative Solution
- ✓ Excess Inventory Management