



**THE DATASHEET OF
AU1PJHM3/84A**



Surface Mount Ultrafast Avalanche Rectifiers

eSMP® Series

SMP (DO-220AA)

Cathode Anode

DESIGN SUPPORT TOOLS

[click logo to get started](#)

PRIMARY CHARACTERISTICS	
$I_{F(AV)}$	1.0 A
V_{RRM}	200 V, 400 V, 600 V, 800 V, 1000 V
I_{FSM}	30 A, 25 A
t_{rr}	75 ns
I_R	1 μ A
E_{AS}	20 mJ
V_F at $I_F = 1.0$ A	1.6 V
T_J max.	175 °C
Package	SMP (DO-220AA)
Circuit configuration	Single

FEATURES

- Very low profile - typical height of 1.0 mm
- Ideal for automated placement
- Glass passivated pellet chip junction
- Ultrafast recovery times for high frequency
- Low reverse current
- Meets MSL level 1, per J-STD-020, LF maximum peak of 260 °C
- AEC-Q101 qualified
- Material categorization: for definitions of compliance please see www.vishay.com/doc?99912

 AUTOMOTIVE
GRADE
Available

RoHS
COMPLIANT
HALOGEN
FREE

TYPICAL APPLICATIONS

For use in secondary rectification and freewheeling for ultrafast switching speeds of AC/AC and DC/DC converters in high temperature conditions for both consumer and automotive applications.

MECHANICAL DATA

Case: SMP (DO-220AA)

Molding compound meets UL 94 V-0 flammability rating
Base P/N-M3 - halogen-free, RoHS-compliant, and commercial grade

Base P/NHM3 - halogen-free, RoHS-compliant, and automotive grade

Terminals: matte tin plated leads, solderable per J-STD-002 and JESD 22-B102

M3 suffix meets JESD 201 class 2 whisker test, HM3 suffix meets JESD 201 class 2 whisker test

MAXIMUM RATINGS ($T_A = 25$ °C unless otherwise noted)								
PARAMETER	SYMBOL	AU1PD	AU1PG	AU1PJ	AU1PK	AU1PM	UNIT	
Device marking code		AUD	AUG	AUJ	AUK	AUM		
Maximum repetitive peak reverse voltage	V_{RRM}	200	400	600	800	1000	V	
Average forward current	$I_{F(AV)}$	1.0						A
Peak forward surge current 10 ms single half sine-wave superimposed on rated load	I_{FSM}	30			25		A	
Non-repetitive avalanche energy at $I_{AS} = 1.0$ A, $T_A = 25$ °C	E_{AS}	20					mJ	
Operating junction and storage temperature range	T_J, T_{STG}	-55 to +175					°C	



ELECTRICAL CHARACTERISTICS (T _A = 25 °C unless otherwise noted)								
PARAMETER	TEST CONDITIONS	SYMBOL	AU1PD	AU1PG	AU1PJ	AU1PK	AU1PM	UNIT
Maximum instantaneous forward voltage	I _F = 1.0 A	T _A = 25 °C	V _F ⁽¹⁾	1.5		1.85		V
		T _A = 125 °C		1.4		1.6		
Maximum reverse current	Rated V _R	T _A = 25 °C	I _R ⁽²⁾	1.0				µA
		T _A = 125 °C		100				
Maximum reverse recovery time	I _F = 0.5 A, I _R = 1.0 A, I _{rr} = 0.25 A	t _{rr}	75				ns	
Typical junction capacitance	4.0 V, 1 MHz	C _J	11		7.5		pF	

Notes

- (1) Pulse test: 300 µs pulse width, 1 % duty cycle
- (2) Pulse test: pulse width ≤ 40 ms

THERMAL CHARACTERISTICS (T _A = 25 °C unless otherwise noted)								
PARAMETER	SYMBOL	AU1PD	AU1PG	AU1PJ	AU1PK	AU1PM	UNIT	
Typical thermal resistance	R _{θJA} ⁽¹⁾	132						°C/W
	R _{θJM} ⁽¹⁾	15						

Note

- (1) Free air, mounted on recommended copper pad area. Thermal resistance R_{θJA} - junction to ambient, R_{θJM} - junction to mount at the terminal cathode band

ORDERING INFORMATION (Example)				
PREFERRED P/N	UNIT WEIGHT (g)	PREFERRED PACKAGE CODE	BASE QUANTITY	DELIVERY MODE
AU1PJ-M3/84A	0.024	84A	3000	7" diameter plastic tape and reel
AU1PJ-M3/85A	0.024	85A	10 000	13" diameter plastic tape and reel
AU1PJHM3/84A ⁽¹⁾	0.024	84A	3000	7" diameter plastic tape and reel
AU1PJHM3/85A ⁽¹⁾	0.024	85A	10 000	13" diameter plastic tape and reel

Note

- (1) AEC-Q101 qualified



RATINGS AND CHARACTERISTICS CURVES ($T_A = 25\text{ }^\circ\text{C}$ unless otherwise noted)

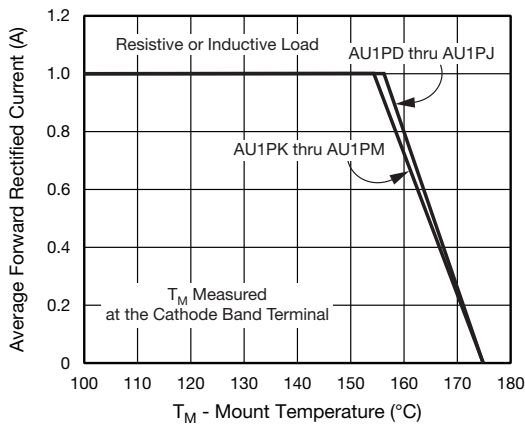

Fig. 1 - Maximum Forward Current Derating Curve

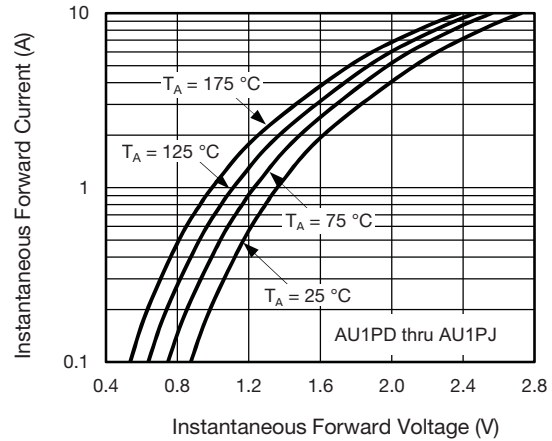

Fig. 4 - Typical Instantaneous Forward Characteristics

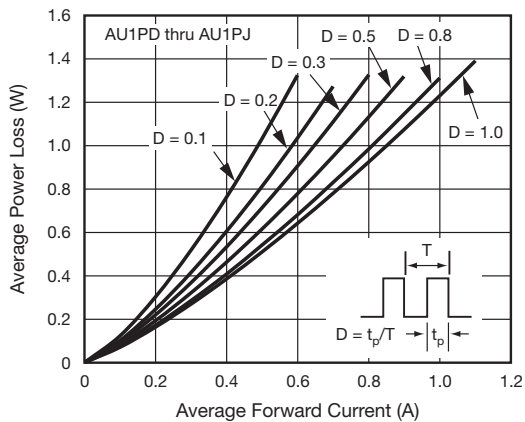

Fig. 2 - Forward Power Loss Characteristics

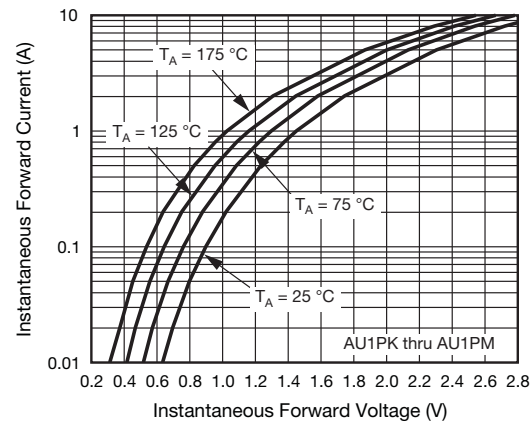

Fig. 5 - Typical Instantaneous Forward Characteristics

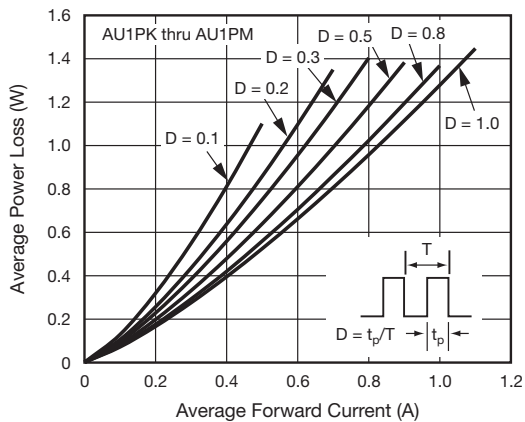

Fig. 3 - Forward Power Loss Characteristics

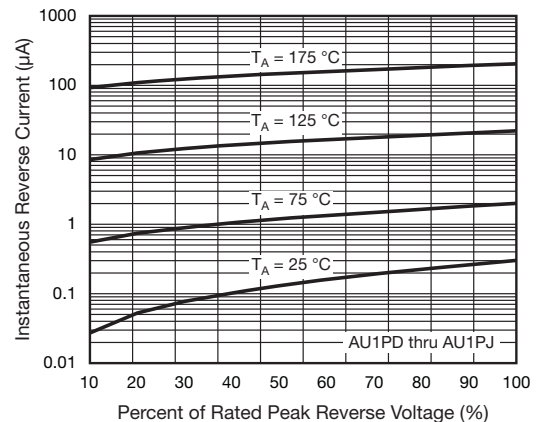

Fig. 6 - Typical Reverse Characteristics

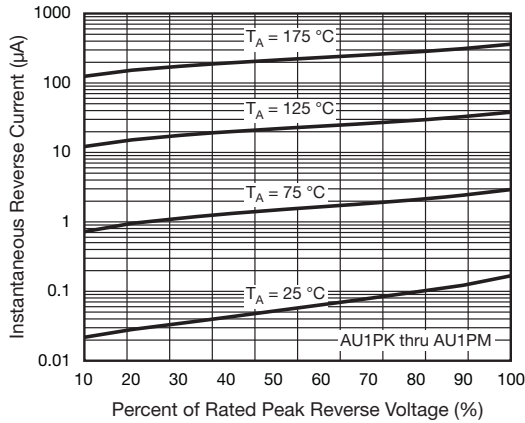

Fig. 7 - Typical Reverse Characteristics

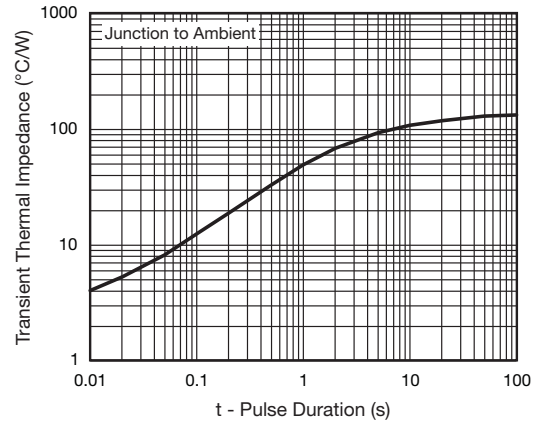

Fig. 9 - Typical Transient Thermal Impedance

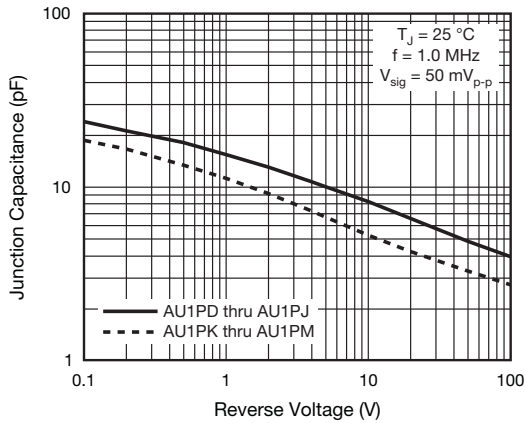
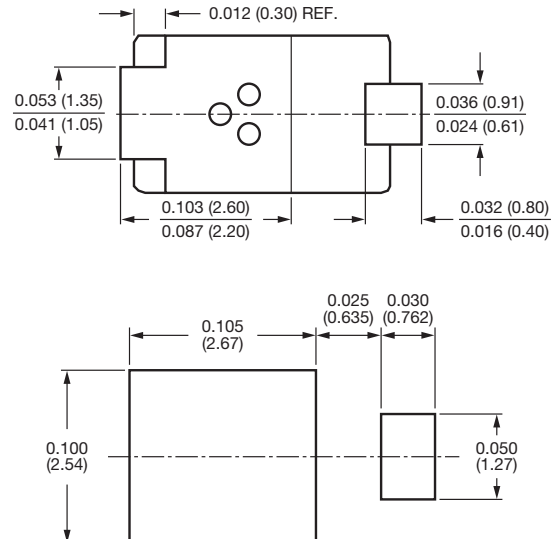
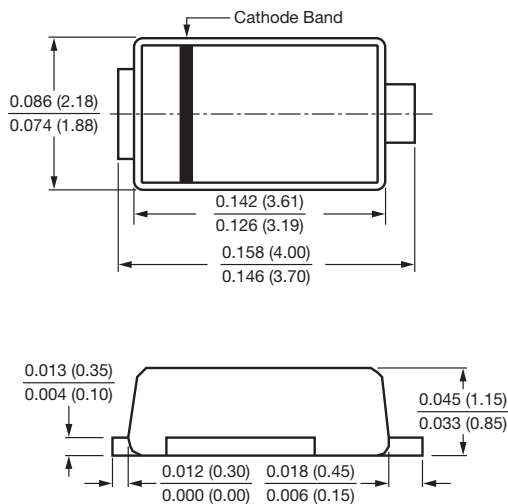

Fig. 8 - Typical Junction Capacitance

PACKAGE OUTLINE DIMENSIONS in inches (millimeters)

SMP (DO-220AA)





Disclaimer

ALL PRODUCT, PRODUCT SPECIFICATIONS AND DATA ARE SUBJECT TO CHANGE WITHOUT NOTICE TO IMPROVE RELIABILITY, FUNCTION OR DESIGN OR OTHERWISE.

Vishay Intertechnology, Inc., its affiliates, agents, and employees, and all persons acting on its or their behalf (collectively, "Vishay"), disclaim any and all liability for any errors, inaccuracies or incompleteness contained in any datasheet or in any other disclosure relating to any product.

Vishay makes no warranty, representation or guarantee regarding the suitability of the products for any particular purpose or the continuing production of any product. To the maximum extent permitted by applicable law, Vishay disclaims (i) any and all liability arising out of the application or use of any product, (ii) any and all liability, including without limitation special, consequential or incidental damages, and (iii) any and all implied warranties, including warranties of fitness for particular purpose, non-infringement and merchantability.

Statements regarding the suitability of products for certain types of applications are based on Vishay's knowledge of typical requirements that are often placed on Vishay products in generic applications. Such statements are not binding statements about the suitability of products for a particular application. It is the customer's responsibility to validate that a particular product with the properties described in the product specification is suitable for use in a particular application. Parameters provided in datasheets and / or specifications may vary in different applications and performance may vary over time. All operating parameters, including typical parameters, must be validated for each customer application by the customer's technical experts. Product specifications do not expand or otherwise modify Vishay's terms and conditions of purchase, including but not limited to the warranty expressed therein.

Except as expressly indicated in writing, Vishay products are not designed for use in medical, life-saving, or life-sustaining applications or for any other application in which the failure of the Vishay product could result in personal injury or death. Customers using or selling Vishay products not expressly indicated for use in such applications do so at their own risk. Please contact authorized Vishay personnel to obtain written terms and conditions regarding products designed for such applications.

No license, express or implied, by estoppel or otherwise, to any intellectual property rights is granted by this document or by any conduct of Vishay. Product names and markings noted herein may be trademarks of their respective owners.

Looking for pricing, stock, or lifecycle information?

Click below to explore more details on WIN SOURCE:

 [View AU1PJHM3/84A on WIN SOURCE](#)

 [Vishay Information](#)

Optimize Your Supply Chain with WIN SOURCE Solutions

-  Global Sourcing Solution
-  Obsolete Management
-  Cost Control Management
-  Shortage Management
-  Alternative Solution
-  Excess Inventory Management