

Surface Mount Type

Series : **S** Type : **V**

High temperature Lead-Free reflow (suffix : A*)



Features

- Endurance : 85 °C 2000 h
- Vibration-proof product is available upon request. ($\phi 8$ mm and larger)
- RoHS compliant

Specifications

Category temperature range	-40 °C to +85 °C							
Rated voltage range	6.3 V.DC to 50 V.DC							
Capacitance range	1 μ F to 1500 μ F							
Capacitance tolerance	± 20 % (120 Hz/+20 °C)							
Leakage current	$I \leq 0.01$ CV or 3 (μ A) After 2 minutes (Whichever is greater)							
Dissipation factor ($\tan \delta$)	Please see the attached characteristics list							
Characteristics at low temperature	V.DC	6.3	10	16	25	35	50	(Impedance ratio at 120 Hz)
	Z(-25 °C)/Z(+20 °C)	4	3	2	2	2	2	
	Z(-40 °C)/Z(+20 °C)	8	6	4	4	3	3	
Endurance	After applying rated working voltage for 2000 hours (Miniaturization product type 1000 hours) at +85 °C ± 2 °C and then being stabilized at +20 °C, Capacitors shall meet the following limits.							
	Capacitance change	Within ± 20 % of the initial value						
		Size code		Cap. change				
		D8 ($\phi 6.3 \times 7.7$)		2000 hours ± 25 %				
\leq D ($\phi 6.3$) Miniature		1000 hours ± 30 %						
$\tan \delta$	≤ 200 % of the initial limit							
DC leakage current	Within the initial limit							
Shelf life	After storage for 1000 hours at +85 °C ± 2 °C with no voltage applied and then being stabilized at +20 °C, capacitors shall meet the limits specified in Endurance. (With voltage treatment)							
Resistance to soldering heat	After reflow soldering and then being stabilized at +20 °C, capacitors shall meet the following limits.							
	Capacitance change	Within ± 10 % of the initial value						
	$\tan \delta$	Within the initial limit						
DC leakage current	Within the initial limit							
AEC-Q200	AEC-Q200 compliant							

Frequency correction factor for ripple current

Frequency (Hz)	50, 60	120	1 k	10 k to
Correction factor	0.70	1.00	1.30	1.70

Marking

Example : 6.3 V.DC 22 μ F
Marking color : BLACK

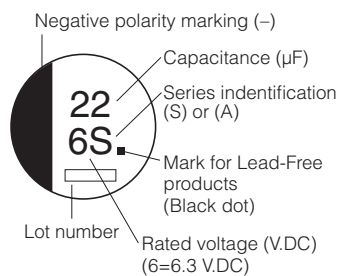

Dimensions

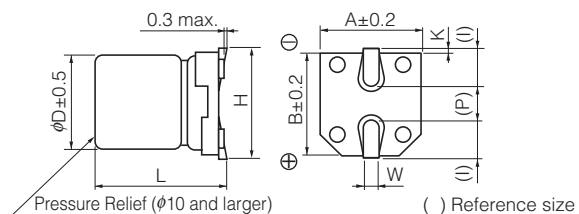

Size code	ϕD	L	A, B	H.	I	W	P	K
B	4.0	5.4 $^{+0.1}_{-0.2}$	4.3	5.5 max	1.8	0.65 ± 0.1	1.0	0.35 $^{+0.15}_{-0.20}$
C	5.0	5.4 $^{+0.1}_{-0.2}$	5.3	6.5 max	2.2	0.65 ± 0.1	1.5	0.35 $^{+0.15}_{-0.20}$
D	6.3	5.4 $^{+0.1}_{-0.2}$	6.6	7.8 max	2.6	0.65 ± 0.1	1.8	0.35 $^{+0.15}_{-0.20}$
D8	6.3	7.7 ± 0.3	6.6	7.8 max	2.6	0.65 ± 0.1	1.8	0.35 $^{+0.15}_{-0.20}$
E	8.0	6.2 ± 0.3	8.3	9.5 max	3.4	0.65 ± 0.1	2.2	0.35 $^{+0.15}_{-0.20}$
F	8.0	10.2 ± 0.3	8.3	10.0 max	3.4	0.90 ± 0.2	3.1	0.70 ± 0.20
G	10.0	10.2 ± 0.3	10.3	12.0 max	3.5	0.90 ± 0.2	4.6	0.70 ± 0.20

Dimensions (Vibration-proof products)

* The size and shape are different from standard products. Please inquire details of our company.

< Size code : D, D8 >

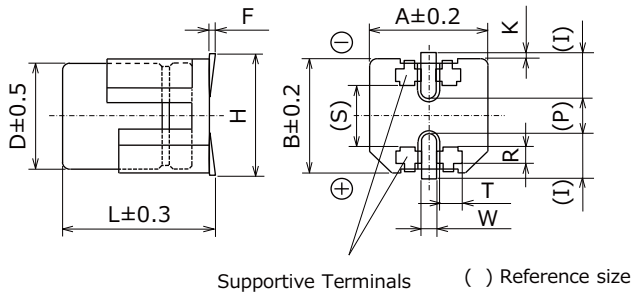

< Size code : E, F, G, H13, J16, K16, K21 >

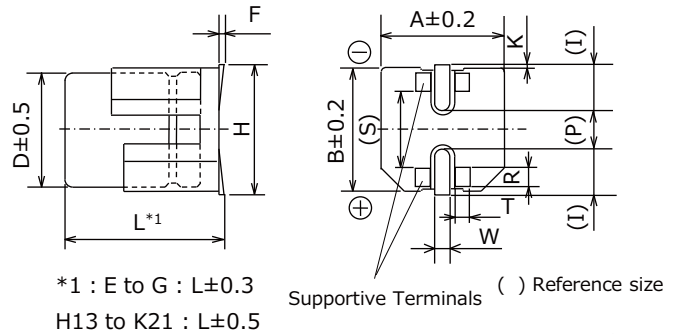

*1 : E to G : L±0.3
H13 to K21 : L±0.5

Unit : mm

Size code	φD	L	A, B	H max.	F	I	W	P	K	R	S	T
D	6.3	6.1	6.6	7.8	0 to +0.15	2.4	0.65±0.1	2.2	0.35 ^{+0.15} _{-0.20}	1.1±0.2	3.3±0.2	1.05±0.2
D8	6.3	8.0	6.6	7.8	0 to +0.15	2.4	0.65±0.1	2.2	0.35 ^{+0.15} _{-0.20}	1.1±0.2	3.3±0.2	1.05±0.2
E	8.0	6.5	8.3	9.5	0 to +0.15	3.4	0.7±0.1	2.2	0.35 ^{+0.15} _{-0.20}	0.70±0.2	5.3±0.2	1.7±0.2
F	8.0	10.5	8.3	10.0	0 to +0.15	3.4	1.2±0.2	3.1	0.70±0.2	0.70±0.2	5.3±0.2	1.3±0.2
G	10.0	10.5	10.3	12.0	0 to +0.15	3.5	1.2±0.2	4.6	0.70±0.2	0.70±0.2	6.9±0.2	1.3±0.2
H13	12.5	13.8	13.5	15.0	-0.1 to +0.15	4.7	1.2±0.2	4.4	0.70±0.3	2.2±0.2	7.1±0.2	2.4±0.2
J16	16.0	16.8	17.0	19.0	-0.1 to +0.15	5.5	1.4±0.2	6.7	0.70±0.3	3.0±0.2	9.0±0.2	1.9±0.2
K16	18.0	16.8	19.0	21.0	-0.1 to +0.15	6.7	1.4±0.2	6.7	0.70±0.3	3.0±0.2	11.0±0.2	1.9±0.2
K21	18.0	21.8	19.0	21.0	-0.1 to +0.15	6.7	1.4±0.2	6.7	0.70±0.3	3.0±0.2	11.0±0.2	1.9±0.2

Land / Pad pattern

The circuit board land/pad pattern size for chip capacitors is specified in the following table. The land pitch influences installation strength and consider it.

● Standard products

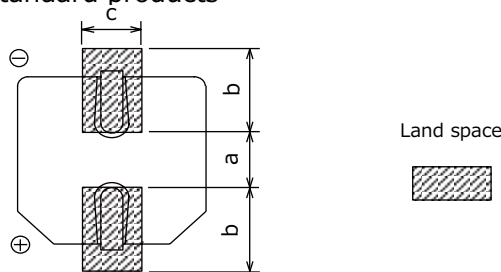

(Table of board land size vs. capacitor size)

Size code	a	b	c
B (φ4)	1.0	2.5	1.6
C (φ5)	1.5	2.8	1.6
D (φ6.3)	1.8	3.2	1.6
D8 (φ6.3x7.7L)	1.8	3.2	1.6
E (φ8x6.2L)	2.2	4.0	1.6
F (φ8x10.2L)	3.1	4.0	2.0
G (φ10x10.2L)	4.6	4.1	2.0
H (φ12.5)	4.0	5.7	2.0
J (φ16)	6.0	6.5	2.5
K (φ18)	6.0	7.5	2.5

Unit : mm

When size "a" is wide, back fillet can be made, decreasing fitting strength.

● Vibration-proof products

< Size code : D, D8 >

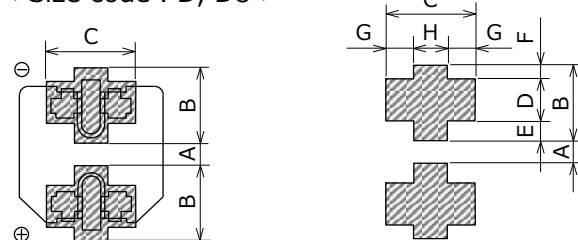

(Table of board land size vs. capacitor size)

Size code	A	B	C	D	E	F	G	H
D (φ6.3xL6.1)	1.2	3.6	3.2	2.0	0.95	0.65	1.0	1.2
D8 (φ6.3xL8.0)	1.2	3.6	3.2	2.0	0.95	0.65	1.0	1.2
E (φ8x6.5L)	1.8	4.2	5.0	1.3	1.5	1.4	1.5	2.0
F (φ8x10.5L)	2.7	4.0	4.7	1.3	1.0	1.7	1.1	2.5
G (φ10)	3.9	4.4	4.7	1.3	1.2	1.9	1.1	2.5
H (φ12.5)	3.9	6.0	6.9	2.8	1.3	1.9	2.2	2.5
J (φ16)	5.8	6.8	6.2	3.6	1.3	1.9	1.7	2.8
K (φ18)	5.8	7.3	6.2	3.6	1.8	1.9	1.7	2.8

Unit : mm

When size "A" is wide, back fillet can be made, decreasing fitting strength.

< Size code : E, F, G, H, J, K >

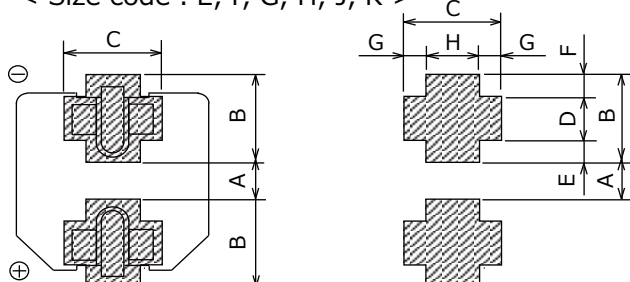

* Take mounting conditions, solderability and fitting strength into consideration when selecting parts for your company's design.

* The vibration-proof capacitors of size φ6.3 has support terminals extending from the bottom side to the lead edge. Then, make sure to find appropriate soldering conditions to form fillet on the support terminals if required for appearance inspection.

Characteristics list

Rated voltage (V.DC)	Cap. (±20 %) (μF)	Case size (mm)		Size* code	Specification			Part No.	Reflow	Min. Packaging Qty	
		φD	L		Ripple current (120 Hz) (+85 °C) (mA r.m.s.)	tan δ (120 Hz) (+20 °C)	Endurance (hours)			Taping (pcs)	
6.3	22	4	5.4	B	29	0.30	2000	EEE0JA220AR	(5)	2000	
	33	4	5.4	(B)	22	0.35	1000	EEE0JA330WAR	(5)	2000	
	47	5	5.4	C	46	0.30	2000	EEE0JA470AR	(5)	1000	
	100	5	5.4	(C)	47	0.40	1000	EEE0JA101WAR	(5)	1000	
		6.3	5.4	D	71	0.30	2000	EEE0JA101AP	(5)	1000	
	330	6.3	7.7	D8	188	0.30	2000	EEE0JA331XAP	(5)	900	
		8	6.2	E	300	0.35	2000	EEE0JA331AP	(7)	1000	
	470	8	10.2	(F)	380	0.35	1000	EEE0JA471UAP	(7)	500	
1000	10	10.2	G	700	0.35	2000	EEE0JA102AP	(7)	500		
1500	10	10.2	(G)	750	0.50	1000	EEE0JA152UAP	(7)	500		
10	22	4	5.4	(B)	28	0.30	1000	EEE1AA220WAR	(5)	2000	
	33	4	5.4	(B)	29	0.30	1000	EEE1AA330WAR	(5)	2000	
		5	5.4	C	43	0.22	2000	EEE1AA330AR	(5)	1000	
	47	5	5.4	(C)	47	0.30	1000	EEE1AA470WAR	(5)	1000	
		5	5.4	(C)	50	0.30	1000	EEE1AA101WAR	(5)	1000	
	100	6.3	5.4	D	70	0.26	2000	EEE1AA101AP	(5)	1000	
		6.3	7.7	D8	173	0.22	2000	EEE1AA221XAP	(5)	900	
	220	8	6.2	E	250	0.26	2000	EEE1AA221AP	(7)	1000	
		8	10.2	(F)	390	0.26	2000	EEE1AA331AP	(7)	500	
	470	8	10.2	(F)	390	0.26	1000	EEE1AA471UAP	(7)	500	
10		10.2	G	400	0.26	2000	EEE1AA471AP	(7)	500		
1000	10	10.2	(G)	580	0.35	1000	EEE1AA102UAP	(7)	500		
16	10	4	5.4	B	28	0.16	2000	EEE1CA100AR	(5)	2000	
	22	4	5.4	(B)	28	0.26	1000	EEE1CA220WAR	(5)	2000	
		5	5.4	C	39	0.16	2000	EEE1CA220AR	(5)	1000	
	33	5	5.4	(C)	35	0.26	1000	EEE1CA330WAR	(5)	1000	
		5	5.4	(C)	39	0.26	1000	EEE1CA470WAR	(5)	1000	
	47	6.3	5.4	D	70	0.16	2000	EEE1CA470AP	(5)	1000	
		6.3	5.4	(D)	70	0.26	1000	EEE1CA101WAP	(5)	1000	
	100	8	6.2	E	200	0.20	2000	EEE1CA101AP	(7)	1000	
		6.3	7.7	D8	162	0.20	2000	EEE1CA221XAP	(5)	900	
	220	8	10.2	(F)	280	0.20	1000	EEE1CA221UAP	(7)	500	
		8	10.2	(F)	320	0.20	1000	EEE1CA331UAP	(7)	500	
	330	10	10.2	G	380	0.20	2000	EEE1CA331AP	(7)	500	
		8	10.2	(F)	350	0.26	1000	EEE1CA471UAP	(7)	500	
	470	10	10.2	G	420	0.20	2000	EEE1CA471AP	(7)	500	
4.7		4	5.4	B	22	0.14	2000	EEE1EA4R7AR	(5)	2000	
10	4	5.4	(B)	22	0.20	1000	EEE1EA100WAR	(5)	2000		
	5	5.4	C	28	0.14	2000	EEE1EA100AR	(5)	1000		
22	5	5.4	(C)	35	0.20	1000	EEE1EA220WAR	(5)	1000		
	6.3	5.4	D	55	0.14	2000	EEE1EA220AP	(5)	1000		
33	5	5.4	(C)	42	0.20	1000	EEE1EA330WAR	(5)	1000		
	6.3	5.4	D	65	0.14	2000	EEE1EA330AP	(5)	1000		
47	6.3	5.4	(D)	70	0.20	1000	EEE1EA470WAP	(5)	1000		
	8	6.2	(E)	91	0.16	1000	EEE1EA101UAP	(7)	1000		
100	6.3	7.7	D8	143	0.16	2000	EEE1EA101XAP	(5)	900		
	8	10.2	F	180	0.16	2000	EEE1EA101AP	(7)	500		
220	8	10.2	(F)	230	0.20	1000	EEE1EA221UAP	(7)	500		
	10	10.2	G	310	0.16	2000	EEE1EA221AP	(7)	500		
330	8	10.2	(F)	270	0.20	1000	EEE1EA331UAP	(7)	500		
	10	10.2	G	340	0.16	2000	EEE1EA331AP	(7)	500		
470	10	10.2	(G)	380	0.25	1000	EEE1EA471UAP	(7)	500		

* Size code() : Miniaturization product
 · Please refer to the page of "Reflow Profile" and "The Taping Dimensions".
 · When requesting vibration-proof product, please put the last "V" instead to "P"

Characteristics list

Rated voltage (V.DC)	Cap. (±20 %) (μF)	Case size (mm)		Size* code	Specification			Part No.	Reflow	Min. Packaging Q'ty
		φD	L		Ripple current (120 Hz) (+85 °C) (mA r.m.s.)	tan δ (120 Hz) (+20 °C)	Endurance (hours)			Taping (pcs)
35	4.7	4	5.4	B	22	0.12	2000	EEE1VA4R7AR	(5)	2000
	10	4	5.4	(B)	22	0.16	1000	EEE1VA100WAR	(5)	2000
		5	5.4	C	30	0.12	2000	EEE1VA100AR	(5)	1000
	22	5	5.4	(C)	36	0.16	1000	EEE1VA220WAR	(5)	1000
		6.3	5.4	D	60	0.12	2000	EEE1VA220AP	(5)	1000
	33	6.3	5.4	(D)	60	0.16	1000	EEE1VA330WAP	(5)	1000
		8	6.2	E	130	0.14	2000	EEE1VA330AP	(7)	1000
	47	6.3	5.4	(D)	70	0.16	1000	EEE1VA470WAP	(5)	1000
		8	6.2	E	165	0.14	2000	EEE1VA470AP	(7)	1000
	100	6.3	7.7	D8	132	0.14	2000	EEE1VA101XAP	(5)	900
		8	10.2	(F)	140	0.14	1000	EEE1VA101UAP	(7)	500
		10	10.2	G	210	0.14	2000	EEE1VA101AP	(7)	500
	220	8	10.2	(F)	200	0.14	1000	EEE1VA221UAP	(7)	500
		10	10.2	G	310	0.14	2000	EEE1VA221AP	(7)	500
330	10	10.2	(G)	350	0.30	1000	EEE1VA331UAP	(7)	500	
50	1	4	5.4	B	10	0.12	2000	EEE1HA1R0AR	(5)	2000
	2.2	4	5.4	B	16	0.12	2000	EEE1HA2R2AR	(5)	2000
	3.3	4	5.4	B	16	0.12	2000	EEE1HA3R3AR	(5)	2000
	4.7	4	5.4	(B)	18	0.14	1000	EEE1HA4R7WAR	(5)	2000
		5	5.4	C	23	0.12	2000	EEE1HA4R7AR	(5)	1000
	10	5	5.4	(C)	27	0.14	1000	EEE1HA100WAR	(5)	1000
		6.3	5.4	D	35	0.12	2000	EEE1HA100AP	(5)	1000
	22	6.3	5.4	(D)	40	0.14	1000	EEE1HA220WAP	(5)	1000
		8	6.2	E	120	0.12	2000	EEE1HA220AP	(7)	1000
	33	8	6.2	(E)	65	0.12	1000	EEE1HA330UAP	(7)	1000
		6.3	7.7	D8	65	0.14	2000	EEE1HA330XAP	(5)	900
		8	10.2	F	110	0.12	2000	EEE1HA330AP	(7)	500
	47	6.3	7.7	D8	105	0.14	2000	EEE1HA470XAP	(5)	900
		8	10.2	(F)	110	0.12	1000	EEE1HA470UAP	(7)	500
		10	10.2	G	130	0.12	2000	EEE1HA470AP	(7)	500
	100	8	10.2	(F)	200	0.18	1000	EEE1HA101UAP	(7)	500
		10	10.2	G	250	0.12	2000	EEE1HA101AP	(7)	500
220	10	10.2	(G)	300	0.18	1000	EEE1HA221UAP	(7)	500	

* Size code() : Miniaturization product

· Please refer to the page of "Reflow Profile" and "The Taping Dimensions".

· When requesting vibration-proof product, please put the last "V" instead to "P"

Guidelines and precautions regarding the technical information and use of our products described in this online catalog.

- If you want to use our products described in this online catalog for applications requiring special qualities or reliability, or for applications where the failure or malfunction of the products may directly jeopardize human life or potentially cause personal injury (e.g. aircraft and aerospace equipment, traffic and transportation equipment, combustion equipment, medical equipment, accident prevention, anti-crime equipment, and/or safety equipment), it is necessary to verify whether the specifications of our products fit to such applications. Please ensure that you will ask and check with our inquiry desk as to whether the specifications of our products fit to such applications use before you use our products.
- The quality and performance of our products as described in this online catalog only apply to our products when used in isolation. Therefore, please ensure you evaluate and verify our products under the specific circumstances in which our products are assembled in your own products and in which our products will actually be used.
- If you use our products in equipment that requires a high degree of reliability, regardless of the application, it is recommended that you set up protection circuits and redundancy circuits in order to ensure safety of your equipment.
- The products and product specifications described in this online catalog are subject to change for improvement without prior notice. Therefore, please be sure to request and confirm the latest product specifications which explain the specifications of our products in detail, before you finalize the design of your applications, purchase, or use our products.
- The technical information in this online catalog provides examples of our products' typical operations and application circuits. We do not guarantee the non-infringement of third party's intellectual property rights and we do not grant any license, right, or interest in our intellectual property.
- If any of our products, product specifications and/or technical information in this online catalog is to be exported or provided to non-residents, the laws and regulations of the exporting country, especially with regard to security and export control, shall be observed.



<Regarding the Certificate of Compliance with the EU RoHS Directive/REACH Regulations>

- The switchover date for compliance with the RoHS Directive/REACH Regulations varies depending on the part number or series of our products.
- When you use the inventory of our products for which it is unclear whether those products are compliant with the RoHS Directive/REACH Regulation, please select "Sales Inquiry" in the website inquiry form and contact us.

We do not take any responsibility for the use of our products outside the scope of the specifications, descriptions, guidelines and precautions described in this online catalog.

Looking for pricing, stock, or lifecycle information?

Click below to explore more details on WIN SOURCE:

-  [View **EEE-0JA152UAP** on WIN SOURCE](#)
-  [Panasonic Information](#)

Optimize Your Supply Chain with WIN SOURCE Solutions

-  Global Sourcing Solution
-  Obsolete Management
-  Cost Control Management
-  Shortage Management
-  Alternative Solution
-  Excess Inventory Management