



**THE DATASHEET OF
ISL28433FBZ**



ISL28233, ISL28433

Dual and Quad Micropower Chopper Stabilized, RRIO Operational Amplifiers

FN7692
Rev 3.00
July 26, 2011

The ISL28233 and ISL28433 are dual and quad micropower, chopper stabilized operational amplifiers that are optimized for single and dual supply operation from 1.8V to 6.0V and $\pm 0.825V$ to $\pm 3.0V$. Their low supply current of $18\mu A$ and wide input range enable the ISL28233, ISL28433 to be excellent general purpose op amps for a wide range of applications. The ISL28233 and ISL28433 are ideal for handheld devices that operate off 2 AA or single Li-ion batteries.

The ISL28233 is available in 8 Ld MSOP, 8 Ld SOIC and 8 Ld DFN packages. The ISL28433 is available in 14 Ld TSSOP, 14 Ld SOIC and 14 Ld 3mmx4mm TDFN packages. All devices operate over the temperature range of $-40^{\circ}C$ to $+125^{\circ}C$.

Related Literature

- See [AN1596](#), "ISL28233SOICEVAL1Z Evaluation Board User's Guide"
- See [AN1575](#), "ISL28433SOICEVAL1Z, ISL28433TSSOPEVAL1Z Evaluation Board User's Guide"

Features

- Low Input Offset Voltage $6\mu V$, Max.
- Low Offset Drift $0.05\mu V/^{\circ}C$, Max.
- Quiescent Current (Per Amplifier) $18\mu A$, Typ.
- Single Supply Range $+1.8V$ to $+6.0V$
- Dual Supply Range $\pm 0.825V$ to $\pm 3.0V$
- Low Noise (0.01Hz to 10Hz) $1.0\mu V_{p-p}$, Typ.
- Rail-to-Rail Inputs and Output
- Input Bias Current $180pA$, Max.
- Operating Temperature Range $-40^{\circ}C$ to $+125^{\circ}C$

Applications

- Bi-Directional Current Sense
- Temperature Measurement
- Medical Equipment
- Electronic Weigh Scales
- Precision/Strain Gauge Sensor
- Precision Regulation
- Low Ohmic Current Sense
- High Gain Analog Front Ends

Typical Application

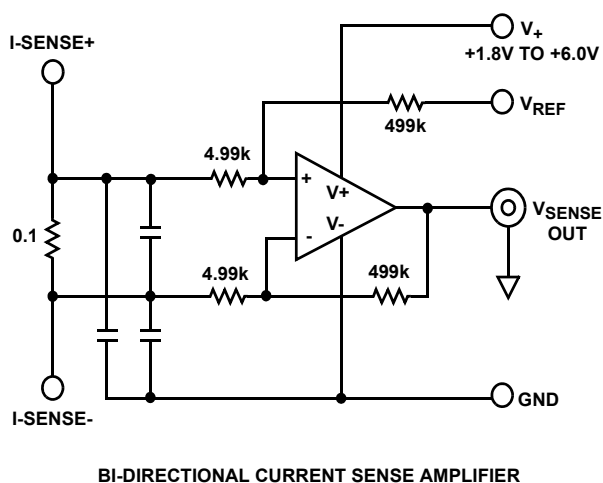

V_{OS} vs Temperature

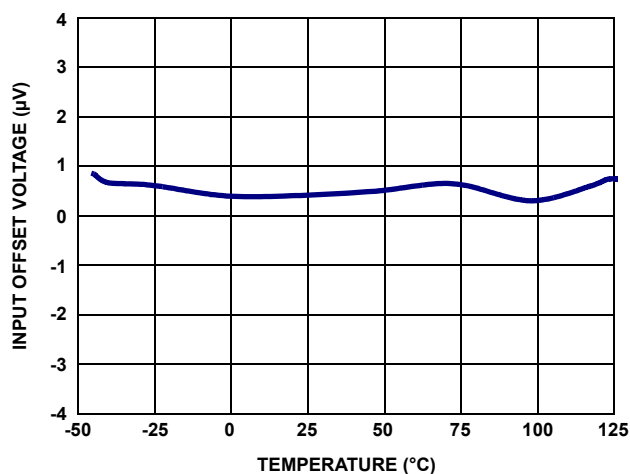

Ordering Information

PART NUMBER (Notes 1, 2, 3)	PART MARKING	PACKAGE (Pb-Free)	PKG. DWG. #
ISL28233FUZ	233FZ	8 Ld MSOP	M8.118A
ISL28233FRZ	233Z	8 Ld 3mmx3mm DFN	L8.3x3J
ISL28233FBZ	28233 FBZ	8 Ld SOIC	M8.15E
ISL28433FBZ	28433 FBZ	14 Ld SOIC	MDP0027
ISL28433FVZ	28433 FVZ	14 Ld TSSOP	MDP0044
<i>Coming Soon</i> ISL28433FRTZ	TBD	14 Ld 3x4 mm TDFN	TBD
ISL28233SOICEVAL1Z	Evaluation Board		
ISL28433TSSOPEVAL1Z	Evaluation Board		
ISL28433SOICEVAL1Z	Evaluation Board		

NOTES:

1. Add "-T*" suffix for tape and reel. Please refer to [TB347](#) for details on reel specifications.
2. These Intersil Pb-free plastic packaged products employ special Pb-free material sets, molding compounds/die attach materials, and 100% matte tin plate plus anneal (e3 termination finish, which is RoHS compliant and compatible with both SnPb and Pb-free soldering operations). Intersil Pb-free products are MSL classified at Pb-free peak reflow temperatures that meet or exceed the Pb-free requirements of IPC/JEDEC J STD-020.
3. For Moisture Sensitivity Level (MSL), please see device information page for [ISL28233](#), [ISL28433](#). For more information on MSL please see techbrief [TB363](#).

Pin Configurations

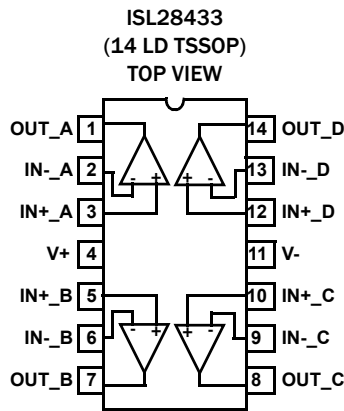
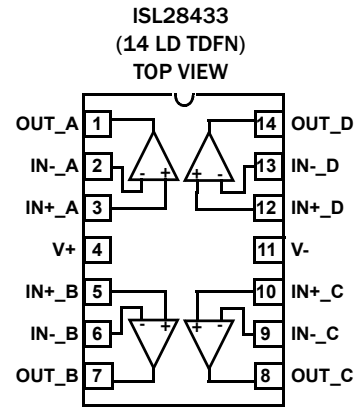
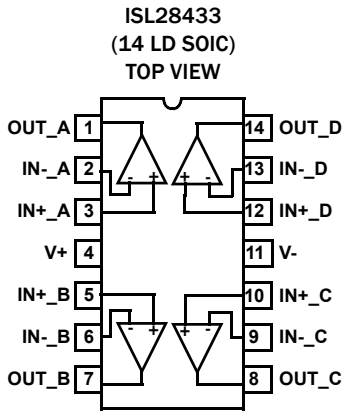
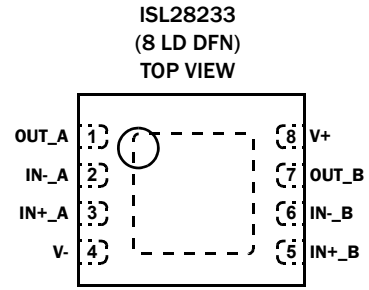
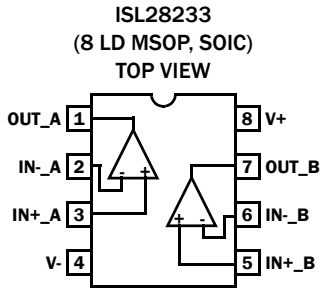

Pin Descriptions

ISL28233 (8 LD MSOP, SOIC, DFN)	ISL28433 (14 LD TSSOP, SOIC, TDFN)	PIN NAME	FUNCTION	EQUIVALENT CIRCUIT
3	3	IN+_A	Non-inverting input	<p>Circuit 1</p>
5	5	IN+_B		
-	10	IN+_C		
-	12	IN+_D		
4	11	V-	Negative supply	
2	2	IN-_A	Inverting input	(See Circuit 1)
6	6	IN-_B		
-	9	IN-_C		
-	13	IN-_D		
1	1	OUT_A	Output	<p>Circuit 2</p>
7	7	OUT_B		
-	8	OUT_C		
-	14	OUT_D		
8	4	V+	Positive supply	
-	-	PAD	Thermal Pad	Thermal Pad. Connect to most negative supply. TDFN and DFN packages only.

Absolute Maximum Ratings

Max Supply Voltage V+ to V-	6.5V
Max Voltage VIN to GND	(V- - 0.3V) to (V+ + 0.3V)V
Max Input Differential Voltage	6.5V
Max Input Current	20mA
Max Voltage VOUT to GND (10s)	±3.0V
ESD Tolerance	
Human Body Model (Tested per JESD22-A114F)	4000V
Machine Model (Tested per JESD22-A115B)	400V
Charged Device Model (Tested per JESD22-C110D)	2000V
Latch-Up (Tested per JESD78B)	+125°C

Thermal Information

Thermal Resistance (Typical)	θ_{JA} (°C/W)	θ_{JC} (°C/W)
14 Ld TSSOP (Notes 4, 7)	110	40
14 Ld SOIC (Notes 4, 7)	75	47
14 Ld TDFN (Notes 5, 6)	TBD	TBD
8 Ld MSOP (Notes 4, 7)	180	65
8 Ld SOIC (Notes 4, 7)	125	90
8 Ld DFN (Notes 5, 6)	53	12
Maximum Storage Temperature Range	-65°C to +150°C	
Pb-Free Reflow Profile	see link below	
	http://www.intersil.com/pbfree/Pb-FreeReflow.asp	

Operating Conditions

Temperature Range	-40°C to +125°C
-------------------------	-----------------

CAUTION: Do not operate at or near the maximum ratings listed for extended periods of time. Exposure to such conditions may adversely impact product reliability and result in failures not covered by warranty.

NOTES:

- θ_{JA} is measured with the component mounted on a high effective thermal conductivity test board in free air. See Tech Brief TB379 for details.
- θ_{JA} is measured in free air with the component mounted on a high effective thermal conductivity test board with “direct attach” features. See Tech Brief [TB379](#).
- For θ_{JC} , the “case temp” location is the center of the exposed metal pad on the package underside.
- For θ_{JC} , the “case temp” location is taken at the package top center.

Electrical Specifications V+ = 5V, V- = 0V, V_{CM} = 2.5V, T_A = +25°C, R_L = 10kΩ, unless otherwise specified. **Boldface limits apply over the operating temperature range, -40°C to +125°C.**

PARAMETER	DESCRIPTION	CONDITIONS	MIN (Note 8)	TYP	MAX (Note 8)	UNIT
DC SPECIFICATIONS						
V _{OS}	Input Offset Voltage		-6	±2	6	μV
		T = -40°C to +125°C	-11	-	11	μV
TCV _{OS}	Input Offset Voltage Temperature Coefficient	T = -40°C to +125°C	-0.05	0.01	0.05	μV/°C
I _{OS}	Input Offset Current		-	10	-	pA
TCI _{OS}	Input Offset Current Temperature Coefficient	T = -40°C to +85°C	-	0.11	-	pA/°C
I _B	Input Bias Current	T = -40°C to +85°C	-180	-	180	pA
		T = -40°C to +125°C	-600	-	600	pA
TCI _B	Input Bias Current Temperature Coefficient	T = -40°C to +85°C	-	0.49	-	pA/°C
CMIR		V+ = 5.0V, V- = 0V Guaranteed by CMRR	-0.1	-	5.1	V
CMRR	Common Mode Rejection Ratio	V _{CM} = -0.1V to 5.1V	118	125	-	dB
			115	-	-	dB
PSRR	Power Supply Rejection Ratio	V _S = 1.8V to 6.0V	110	138	-	dB
			110	-	-	dB
V _{OH}	Output Voltage, High		4.965	4.981	-	V
V _{OL}	Output Voltage, Low		-	18	35	mV
A _{OL}	Open Loop Gain	R _L = 1MΩ	-	174	-	dB
V+	Supply Voltage	Guaranteed by PSRR	1.8	-	6.0	V
I _S	Supply Current, Per Amplifier	R _L = OPEN	-	18	25	μA
			-	-	35	μA

Electrical Specifications $V_+ = 5V$, $V_- = 0V$, $V_{CM} = 2.5V$, $T_A = +25^\circ C$, $R_L = 10k\Omega$, unless otherwise specified. **Boldface limits apply over the operating temperature range, $-40^\circ C$ to $+125^\circ C$. (Continued)**

PARAMETER	DESCRIPTION	CONDITIONS	MIN (Note 8)	TYP	MAX (Note 8)	UNIT
I_{SC+}	Output Source Short Circuit Current	$R_L = \text{Short to } V_-$	13	17	26	mA
I_{SC-}	Output Sink Short Circuit Current	$R_L = \text{Short to } V_+$	-26	-19	-13	mA
AC SPECIFICATIONS						
GBWP	Gain Bandwidth Product	$A_V = 100$, $R_F = 100k\Omega$, $R_G = 1k\Omega$, $R_L = 10k\Omega$ to V_{CM}	-	400	-	kHz
$e_N V_{P-P}$	Peak-to-Peak Input Noise Voltage	$f = 0.01\text{Hz to } 10\text{Hz}$	-	1.0	-	μV_{P-P}
e_N	Input Noise Voltage Density	$f = 1\text{kHz}$	-	65	-	$nV/\sqrt{\text{Hz}}$
i_N	Input Noise Current Density	$f = 1\text{kHz}$	-	72	-	$fA/\sqrt{\text{Hz}}$
		$f = 10\text{Hz}$	-	79	-	$fA/\sqrt{\text{Hz}}$
C_{in}	Differential Input Capacitance	$f = 1\text{MHz}$	-	1.6	-	pF
	Common Mode Input Capacitance		-	1.12	-	pF
TRANSIENT RESPONSE						
SR	Positive Slew Rate	$V_{OUT} = 1V$ to $4V$, $R_L = 10k\Omega$	-	0.2	-	$V/\mu s$
	Negative Slew Rate		-	0.1	-	$V/\mu s$
t_r , t_f , Small Signal	Rise Time, t_r 10% to 90%	$A_V = +1$, $V_{OUT} = 0.1V_{P-P}$, $R_F = 0\Omega$, $R_L = 10k\Omega$, $C_L = 1.2pF$	-	1.1	-	μs
	Fall Time, t_f 10% to 90%		-	1.1	-	μs
t_r , t_f Large Signal	Rise Time, t_r 10% to 90%	$A_V = +1$, $V_{OUT} = 2V_{P-P}$, $R_F = 0\Omega$, $R_L = 10k\Omega$, $C_L = 1.2pF$	-	20	-	μs
	Fall Time, t_f 10% to 90%		-	30	-	μs
t_s	Settling Time to 0.1%, $2V_{P-P}$ Step	$A_V = +1$, $R_F = 0\Omega$, $R_L = 10k\Omega$, $C_L = 1.2pF$	-	35	-	μs
$t_{recover}$	Output Overload Recovery Time, Recovery to 90% of output saturation	$A_V = +2$, $R_F = 10k\Omega$, $R_L = \text{Open}$, $C_L = 3.7pF$	-	10.5	-	μs

NOTE:

8. Compliance to datasheet limits is assured by one or more methods: production test, characterization and/or design.

Typical Performance Curves $V_+ = 5V, V_- = 0V, V_{CM} = 2.5V, R_L = \text{Open}, T = +25^\circ\text{C}$, unless otherwise specified.

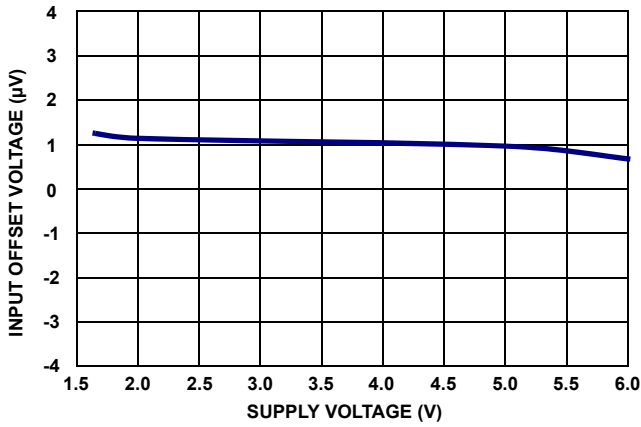

FIGURE 1. V_{OS} vs SUPPLY VOLTAGE

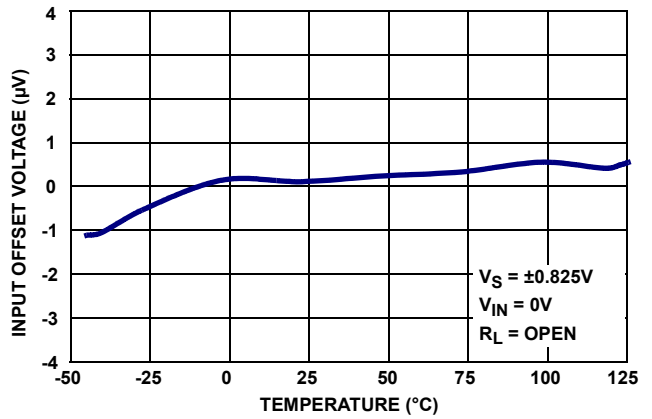

FIGURE 2. V_{OS} vs TEMPERATURE

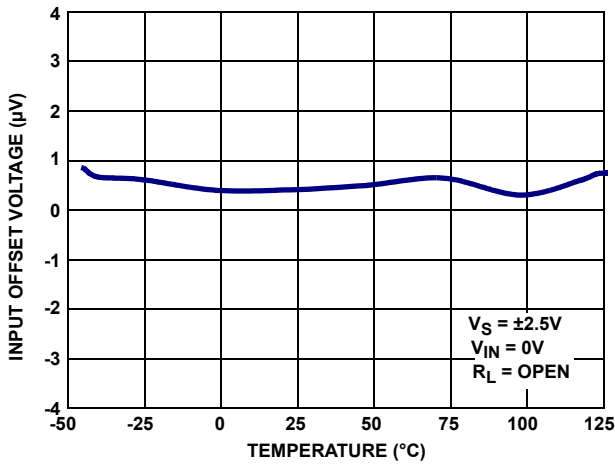

FIGURE 3. V_{OS} vs TEMPERATURE

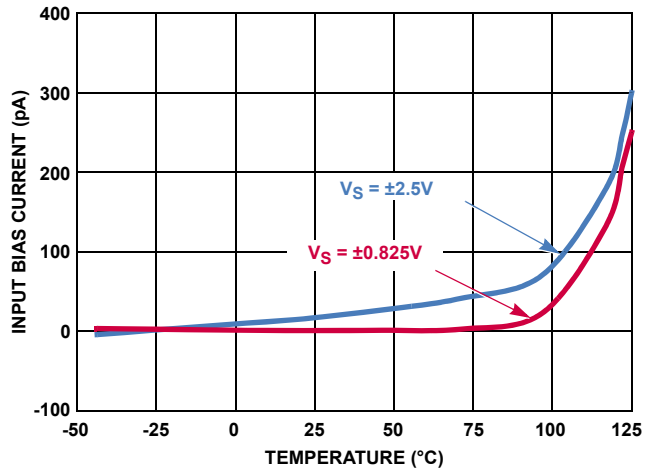

FIGURE 4. I_{B+} vs TEMPERATURE

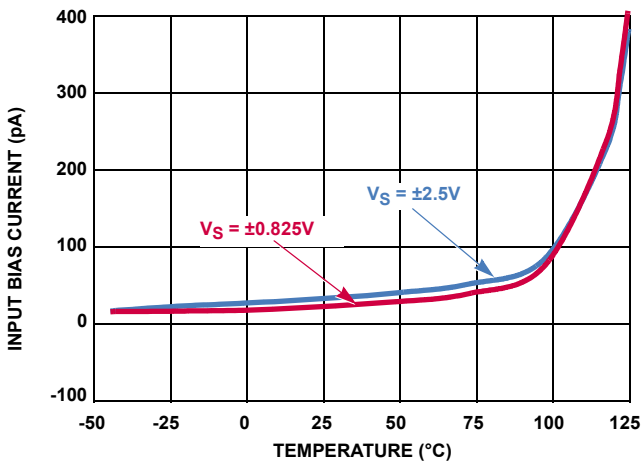

FIGURE 5. I_B vs TEMPERATURE

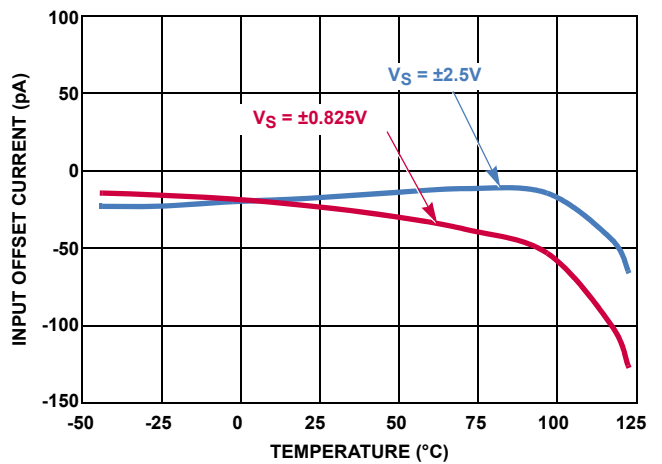

FIGURE 6. I_{OS} vs TEMPERATURE

Typical Performance Curves $V_+ = 5V, V_- = 0V, V_{CM} = 2.5V, R_L = \text{Open}, T = +25^\circ\text{C}$, unless otherwise specified. (Continued)

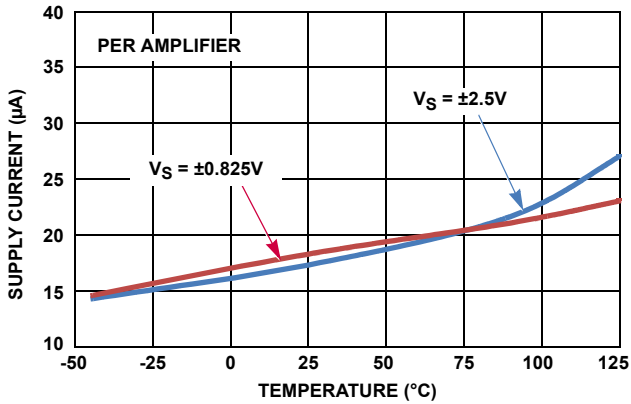

FIGURE 7. SUPPLY CURRENT vs TEMPERATURE

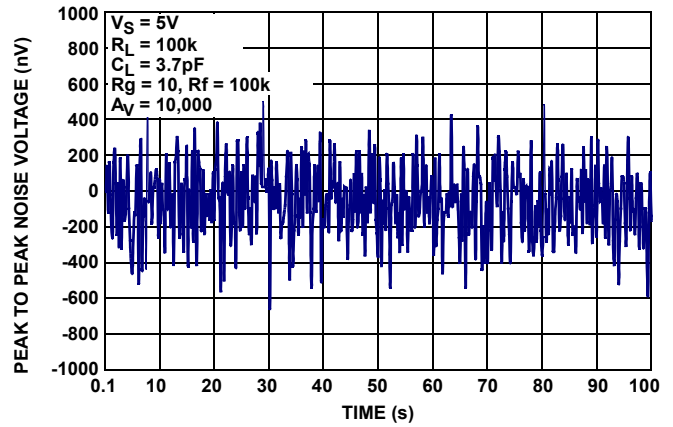

FIGURE 8. INPUT NOISE VOLTAGE 0.01Hz TO 10Hz

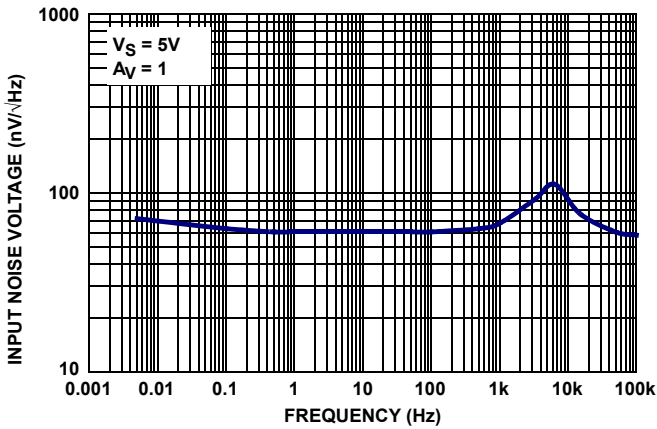

FIGURE 9. INPUT NOISE VOLTAGE DENSITY vs FREQUENCY

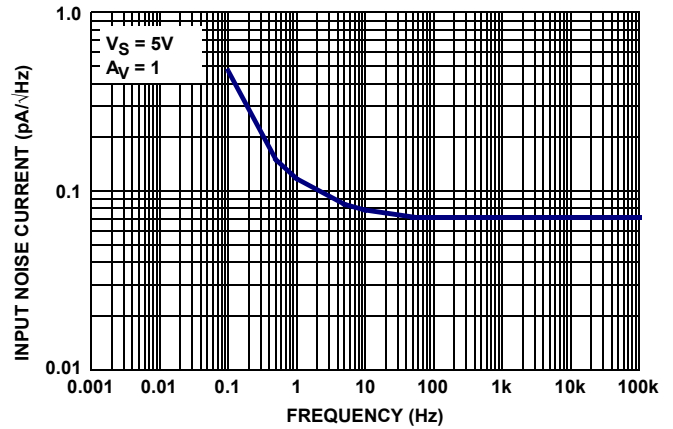

FIGURE 10. INPUT NOISE CURRENT DENSITY vs FREQUENCY

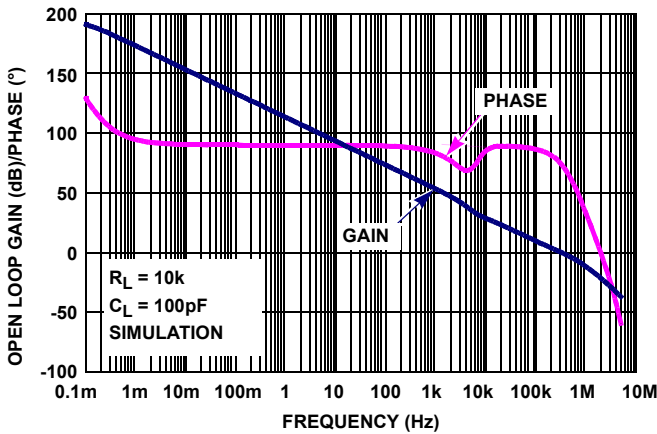

FIGURE 11. FREQUENCY RESPONSE vs OPEN LOOP GAIN, $R_L = 10k\Omega$

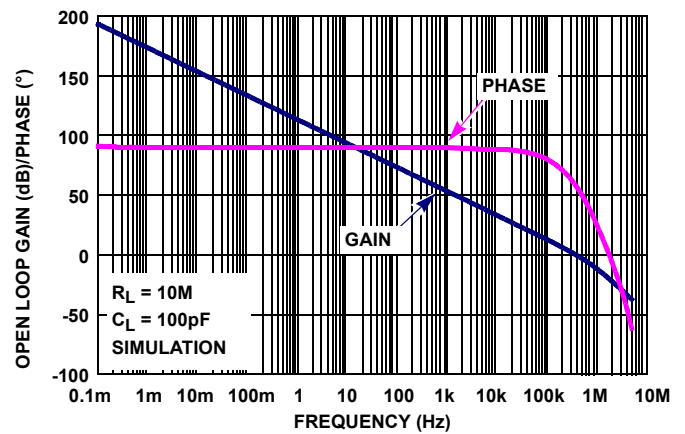

FIGURE 12. FREQUENCY RESPONSE vs OPEN LOOP GAIN, $R_L = 10M\Omega$

Typical Performance Curves $V_+ = 5V, V_- = 0V, V_{CM} = 2.5V, R_L = \text{Open}, T = +25^\circ\text{C}$, unless otherwise specified. (Continued)

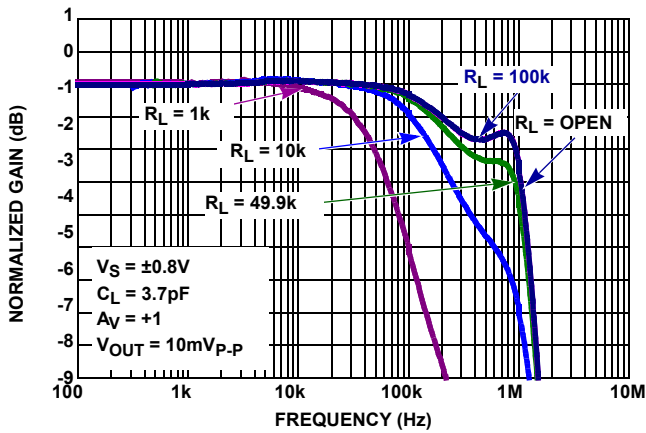

FIGURE 13. GAIN vs FREQUENCY vs $R_L, V_S = \pm 0.8V$

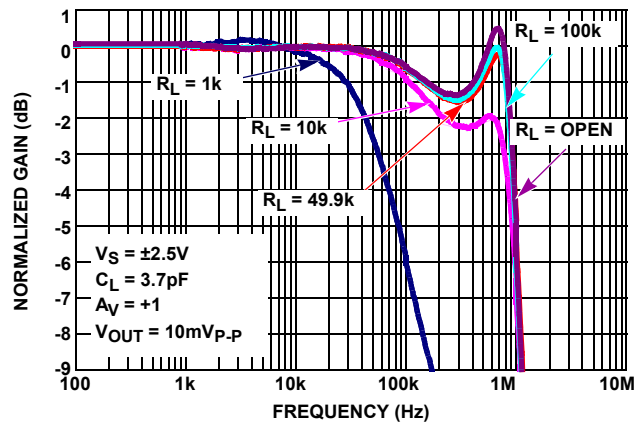

FIGURE 14. GAIN vs FREQUENCY vs $R_L, V_S = \pm 2.5V$

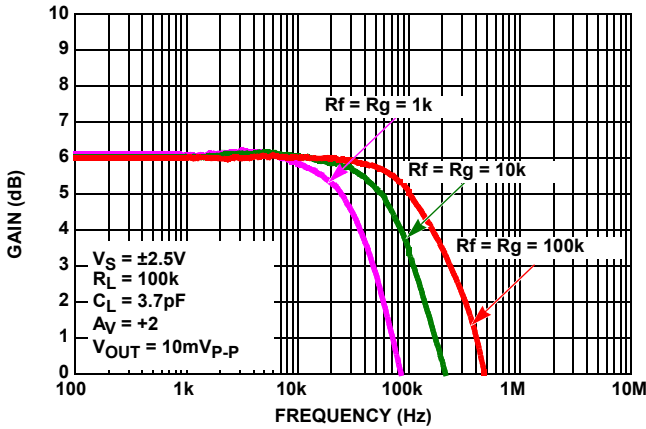

FIGURE 15. GAIN vs FREQUENCY vs FEEDBACK RESISTOR VALUES R_f/R_g

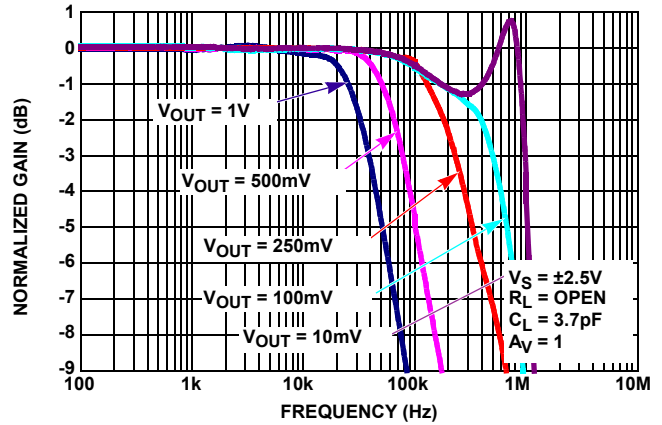

FIGURE 16. GAIN vs FREQUENCY vs $V_{OUT}, R_L = \text{OPEN}$

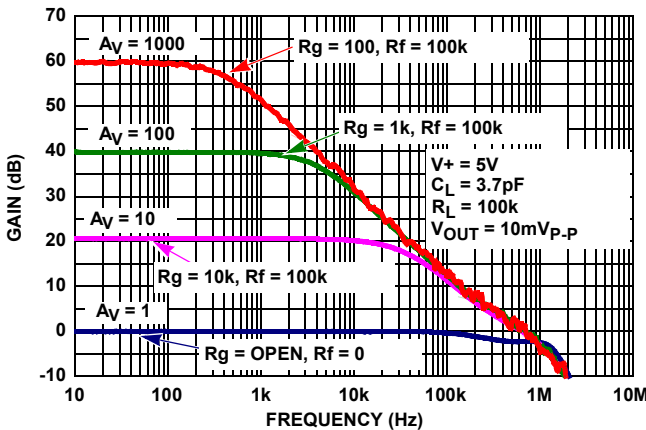

FIGURE 17. FREQUENCY RESPONSE vs CLOSED LOOP GAIN

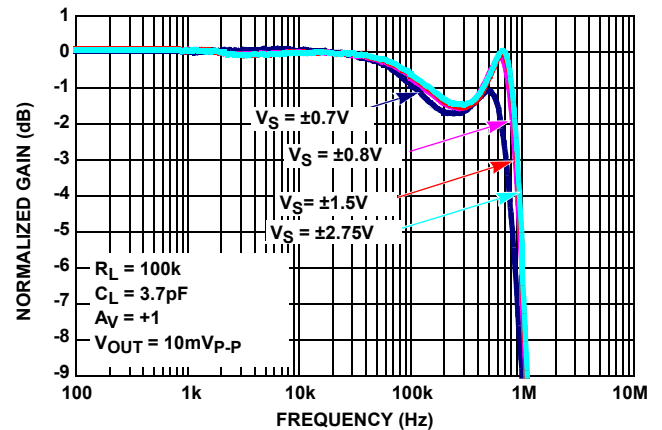

FIGURE 18. GAIN vs FREQUENCY vs SUPPLY VOLTAGE

Typical Performance Curves $V_+ = 5V, V_- = 0V, V_{CM} = 2.5V, R_L = \text{Open}, T = +25^\circ\text{C}$, unless otherwise specified. (Continued)

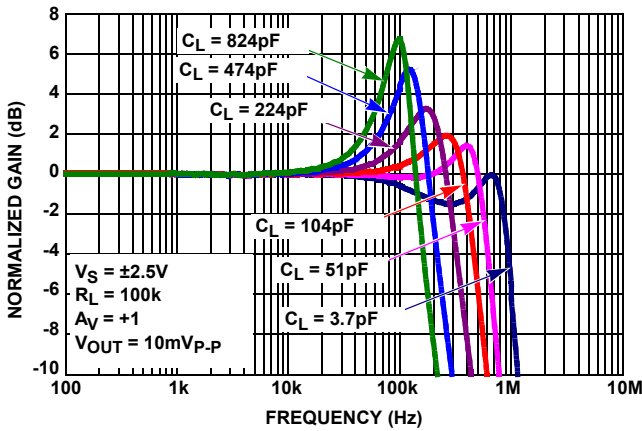

FIGURE 19. GAIN vs FREQUENCY vs C_L

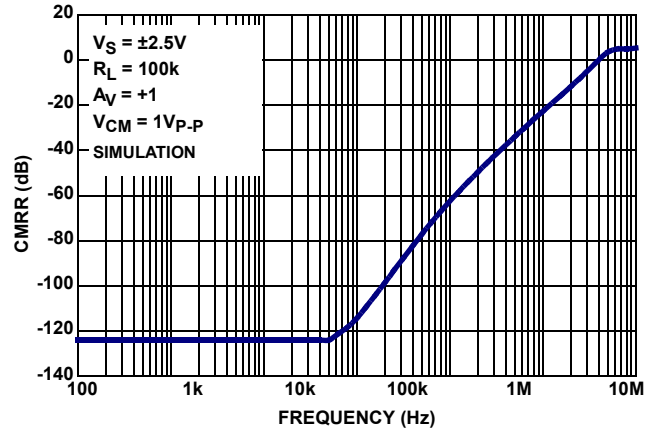

FIGURE 20. CMRR vs FREQUENCY, $V_S = \pm 2.5V$

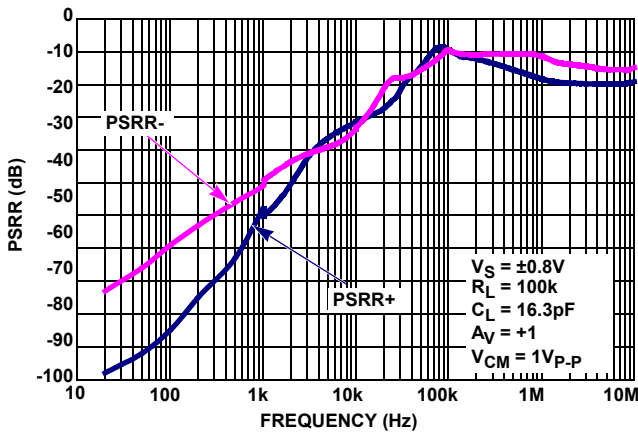

FIGURE 21. PSRR vs FREQUENCY, $V_S = \pm 0.8V$

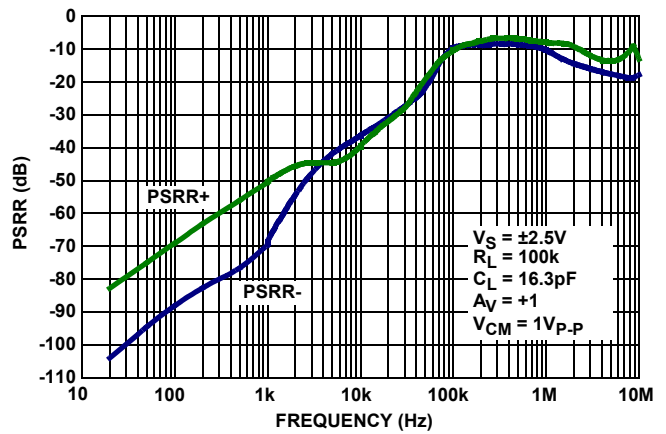

FIGURE 22. PSRR vs FREQUENCY, $V_S = \pm 2.5V$

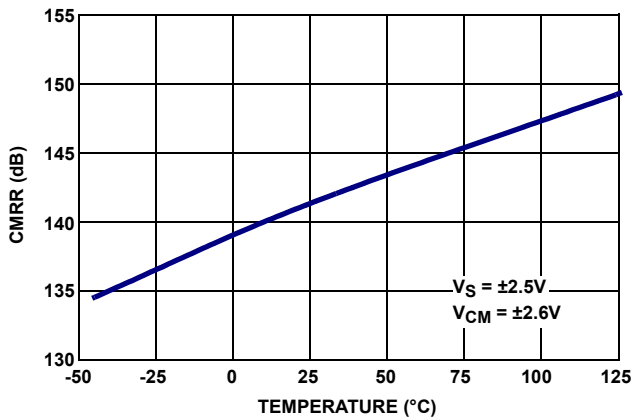

FIGURE 23. CMRR vs TEMPERATURE

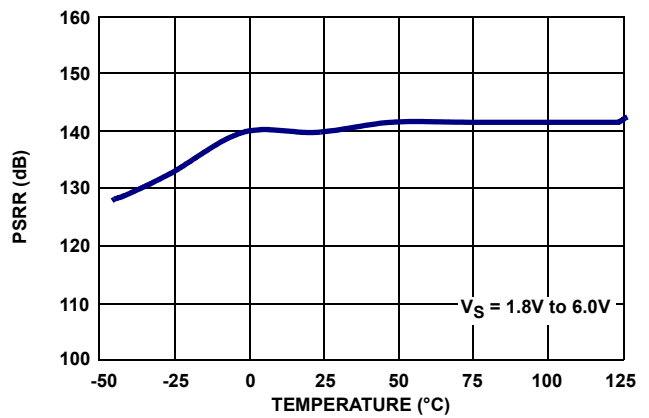

FIGURE 24. PSRR vs TEMPERATURE

Typical Performance Curves $V_+ = 5V, V_- = 0V, V_{CM} = 2.5V, R_L = \text{Open}, T = +25^\circ C$, unless otherwise specified. (Continued)

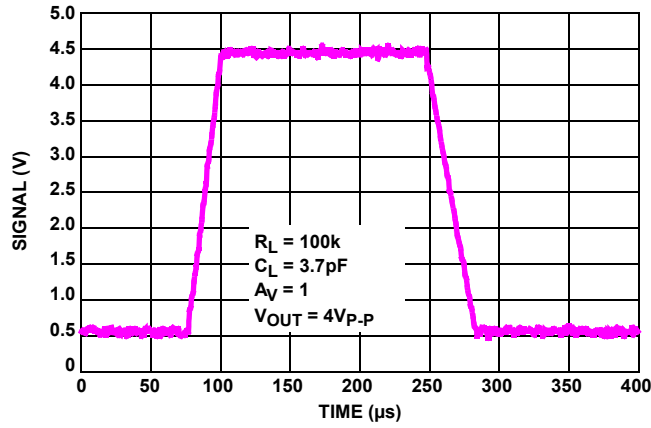

FIGURE 25. LARGE SIGNAL STEP RESPONSE (4V)

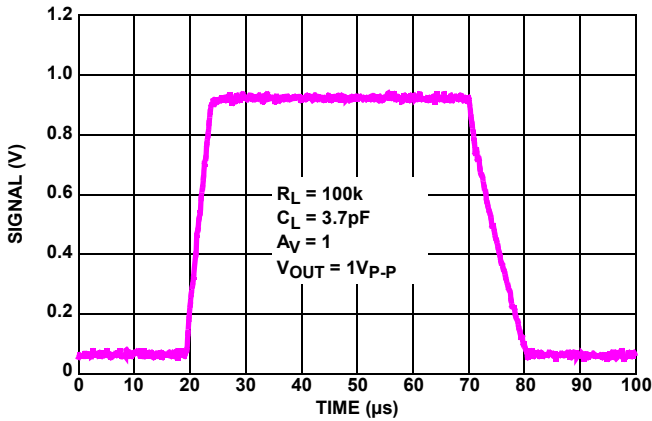

FIGURE 26. LARGE SIGNAL STEP RESPONSE (1V)

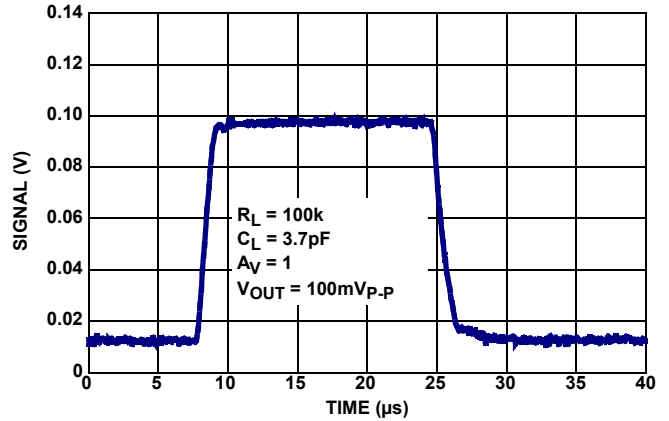

FIGURE 27. SMALL SIGNAL STEP RESPONSE (100mV)

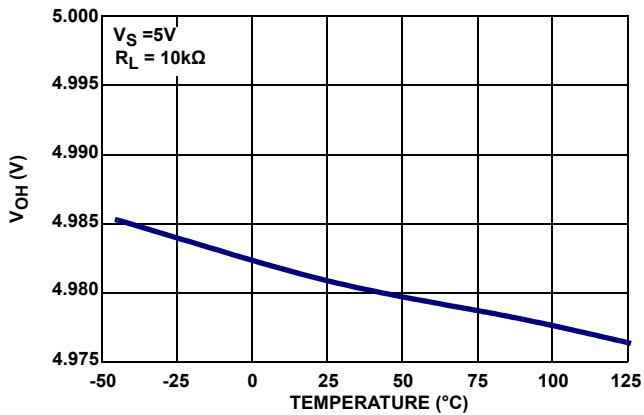

FIGURE 28. V_{OH} vs TEMPERATURE

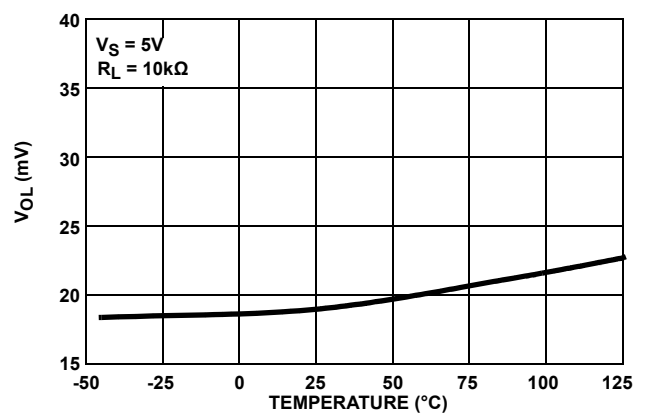

FIGURE 29. V_{OL} vs TEMPERATURE

Typical Performance Curves $V_+ = 5V, V_- = 0V, V_{CM} = 2.5V, R_L = \text{Open}, T = +25^\circ\text{C}$, unless otherwise specified. (Continued)

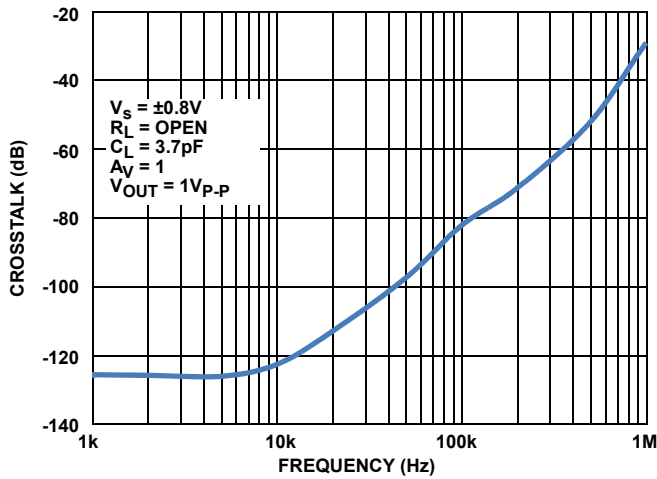

FIGURE 30. CROSSTALK vs FREQUENCY, $V_S = \pm 0.8V$

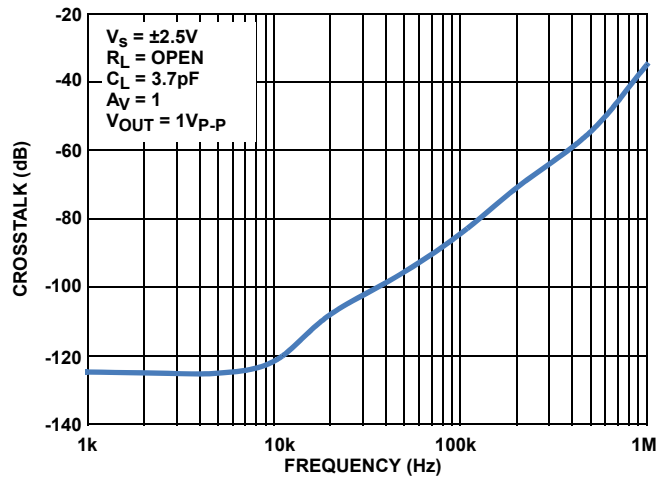

FIGURE 31. CROSSTALK vs FREQUENCY, $V_S = \pm 2.5V$

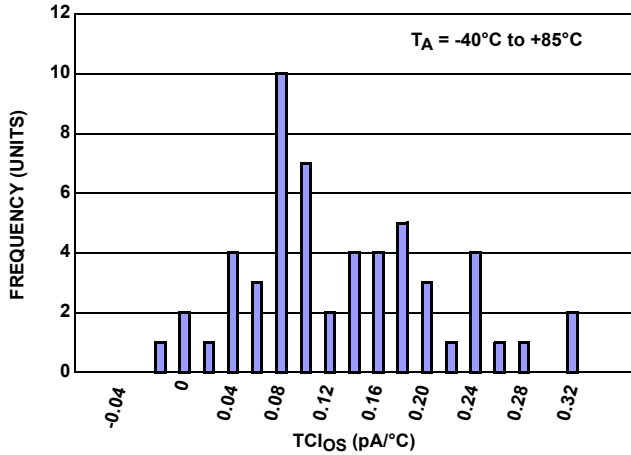

FIGURE 32. $TC_{I_{OS}}$ HISTOGRAM

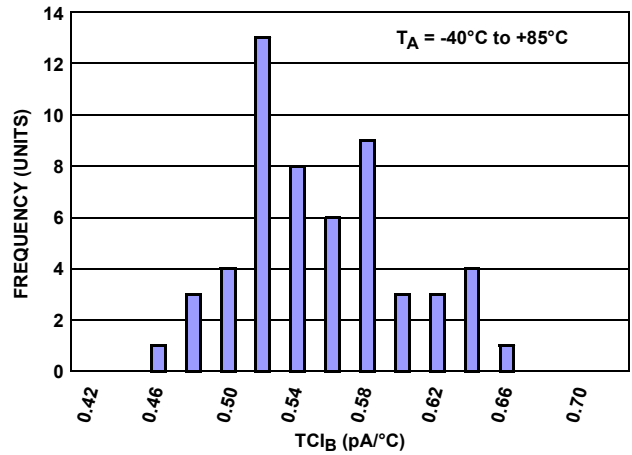

FIGURE 33. TC_{I_B} HISTOGRAM

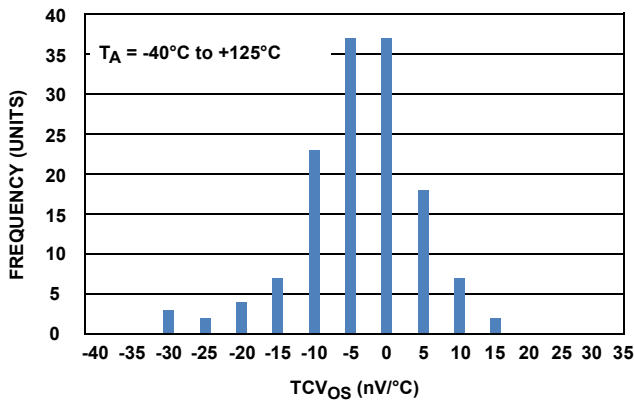

FIGURE 34. TCV_{OS} HISTOGRAM

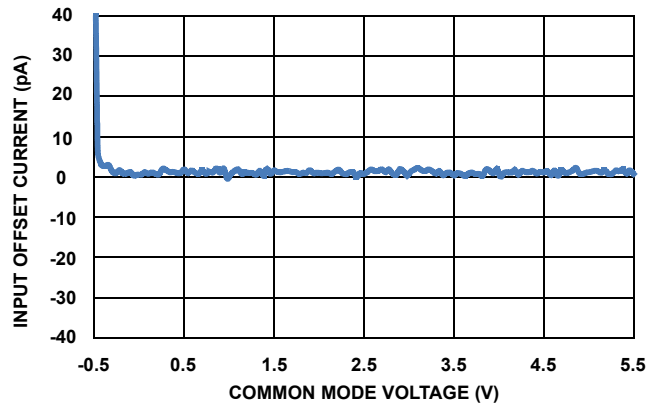

FIGURE 35. I_{OS} vs V_{CM}

Typical Performance Curves $V_+ = 5V, V_- = 0V, V_{CM} = 2.5V, R_L = \text{Open}, T = +25^\circ\text{C}$, unless otherwise specified. (Continued)

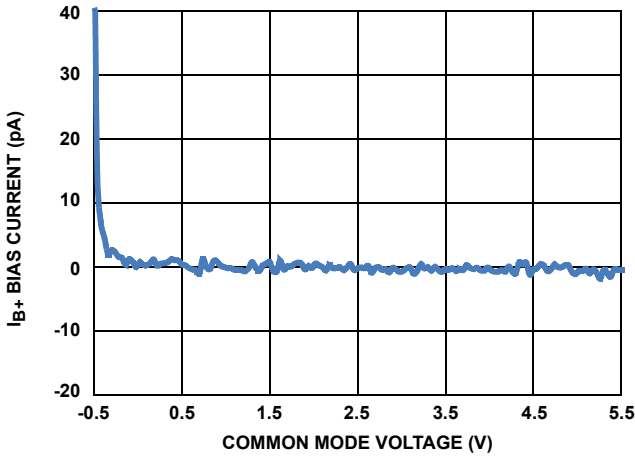

FIGURE 36. I_{B+} vs V_{CM}

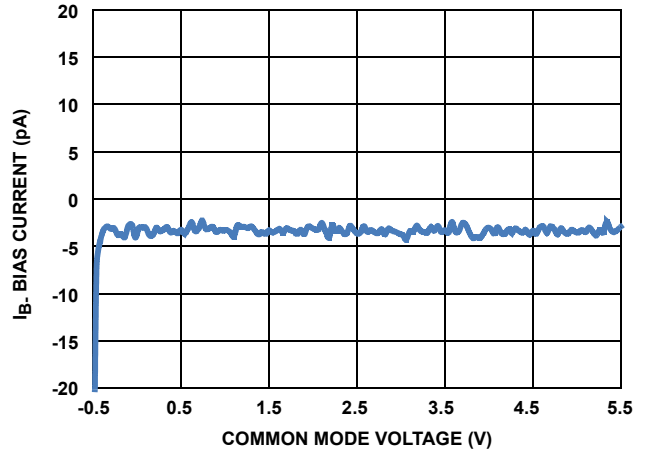

FIGURE 37. I_{B-} vs V_{CM}

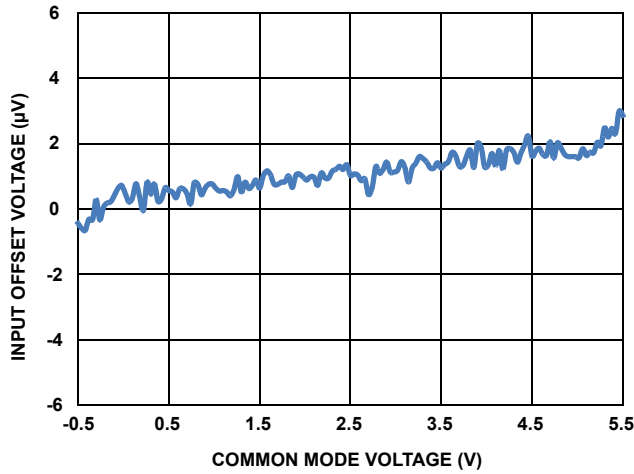

FIGURE 38. V_{OS} vs V_{CM}

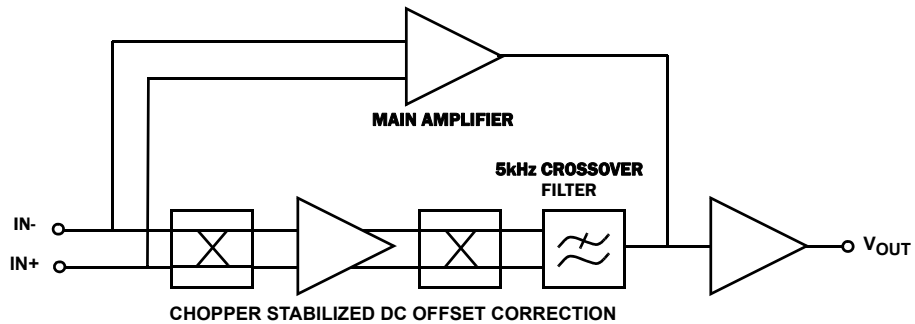

FIGURE 39. ISL28233, ISL28433 FUNCTIONAL BLOCK DIAGRAM

Applications Information

Functional Description

The ISL28233 and ISL28433 use a proprietary chopper-stabilized technique (see Figure 39) that combines a 400kHz main amplifier with a very high open loop gain (174dB) chopper amplifier to achieve very low offset voltage and drift ($2\mu\text{V}$, $0.01\mu\text{V}/^\circ\text{C}$ typical) while consuming only $18\mu\text{A}$ of supply current per channel.

This multi-path amplifier architecture contains a time continuous main amplifier whose input DC offset is corrected by a parallel-connected, high gain chopper stabilized DC correction amplifier operating at 100kHz. From DC to $\sim 5\text{kHz}$, both amplifiers are active with DC offset correction and most of the low frequency gain is provided by the chopper amplifier. A 5kHz crossover filter cuts off the low frequency amplifier path leaving the main amplifier active out to the 400kHz gain-bandwidth product of the device.

The key benefits of this architecture for precision applications are very high open loop gain, very low DC offset, and low $1/f$ noise. The noise is virtually flat across the frequency range from a few millihertz out to 100kHz, except for the narrow noise peak at the amplifier crossover frequency (5kHz).

Rail-to-rail Input and Output (RRIO)

The RRIO CMOS amplifier uses parallel input PMOS and NMOS that enable the inputs to swing 100mV beyond either supply rail. The inverting and non-inverting inputs do not have back-to-back input clamp diodes and are capable of maintaining high input impedance at high differential input voltages. This is effective in eliminating output distortion caused by high slew-rate input signals.

The output stage uses common source connected PMOS and NMOS devices to achieve rail-to-rail output drive capability with 17mA current limit and the capability to swing to within 20mV of either rail while driving a $10\text{k}\Omega$ load.

IN+ and IN- Protection

All input terminals have internal ESD protection diodes to both positive and negative supply rails, limiting the input voltage to within one diode beyond the supply rails. For applications where either input is expected to exceed the rails by 0.5V , an external series resistor must be used to ensure the input currents never exceed 20mA (see Figure 40).

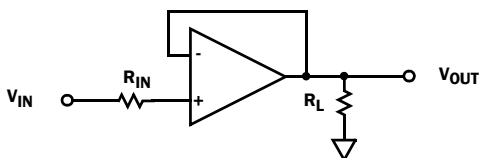

FIGURE 40. INPUT CURRENT LIMITING

Layout Guidelines for High Impedance Inputs

To achieve the maximum performance of the high input impedance and low offset voltage of the ISL28233 and ISL28433 amplifiers, care should be taken in the circuit board layout. The PCB board surface must remain clean and free of moisture to avoid leakage currents between adjacent traces. Surface coating of the circuit board will reduce surface moisture and provide a humidity barrier, reducing parasitic resistance on the board.

High Gain, Precision DC-Coupled Amplifier

The circuit in Figure 41 implements a single-stage DC-coupled amplifier with an input DC sensitivity of under 100nV that is only possible using a low VOS amplifier with high open loop gain. High gain DC amplifiers operating from low voltage supplies are not practical using typical low offset precision op amps. For example, a typical precision amplifier in a gain of $10\text{kV}/\text{V}$ with a $\pm 100\mu\text{V}$ V_{OS} and offset drift $0.5\mu\text{V}/^\circ\text{C}$ of a low offset op amp would produce a DC error of $>1\text{V}$ with an additional $5\text{mV}/^\circ\text{C}$ of temperature dependent error making it difficult to resolve DC input voltage changes in the mV range.

The $\pm 6\mu\text{V}$ max V_{OS} and $0.05\mu\text{V}/^\circ\text{C}$ max temperature drift of the ISL28233, ISL28433 produces a temperature stable maximum DC output error of only $\pm 60\text{mV}$ with a maximum output temperature drift of $0.5\text{mV}/^\circ\text{C}$. The additional benefit of a very low $1/f$ noise corner frequency and some feedback filtering enables DC voltages and voltage fluctuations well below 100nV to be easily detected with a simple single stage amplifier.

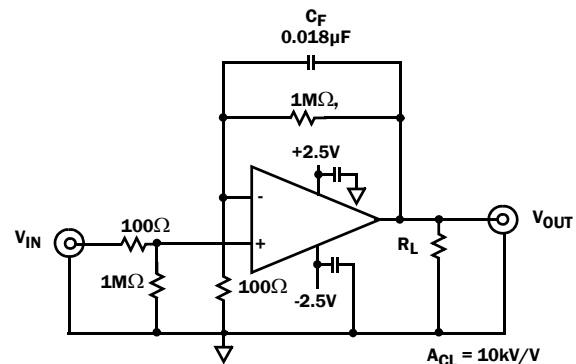

FIGURE 41. HIGH GAIN, PRECISION DC-COUPLED AMPLIFIER

ISL28233, ISL28433 SPICE Model

Figure 42 shows the SPICE model schematic and Figure 43 shows the net list for the ISL28233, ISL28433 SPICE model. The model is a simplified version of the actual device and simulates important parameters such as noise, Slew Rate, Gain and Phase. The model uses typical parameters from the “Electrical Specifications Table” on page 5. The poles and zeroes in the model were determined from the actual open and closed-loop gain and phase response. This enables the model to present an accurate AC representation of the actual device. The model is configured for ambient temperature of $+25^\circ\text{C}$.

Figures 44 through 51 show the characterization vs simulation results for the Noise Density, Frequency Response vs Close Loop Gain, Gain vs Frequency vs C_L and Large Signal Step Response (4V).

LICENSE STATEMENT

The information in this SPICE model is protected under the United States copyright laws. Intersil Corporation hereby grants users of this macro-model hereto referred to as “Licensee”, a nonexclusive, nontransferable licence to use this model as long as the Licensee abides by the terms of this agreement. Before using this macro-model, the Licensee should read this license. If the Licensee does not accept these terms, permission to use the model is not granted.

The Licensee may not sell, loan, rent, or license the macro-model, in whole, in part, or in modified form, to anyone outside the Licensee's company. The Licensee may modify the macro-model to suit his/her specific applications, and the Licensee may make copies of this macro-model for use within their company only.

This macro-model is provided "AS IS, WHERE IS, AND WITH NO WARRANTY OF ANY KIND EITHER EXPRESSED OR IMPLIED, INCLUDING BUY NOT LIMITED TO ANY IMPLIED WARRANTIES OF MERCHANTABILITY AND FITNESS FOR A PARTICULAR PURPOSE."

In no event will Intersil be liable for special, collateral, incidental, or consequential damages in connection with or arising out of the use of this macro-model. Intersil reserves the right to make changes to the product and the macro-model without prior notice.

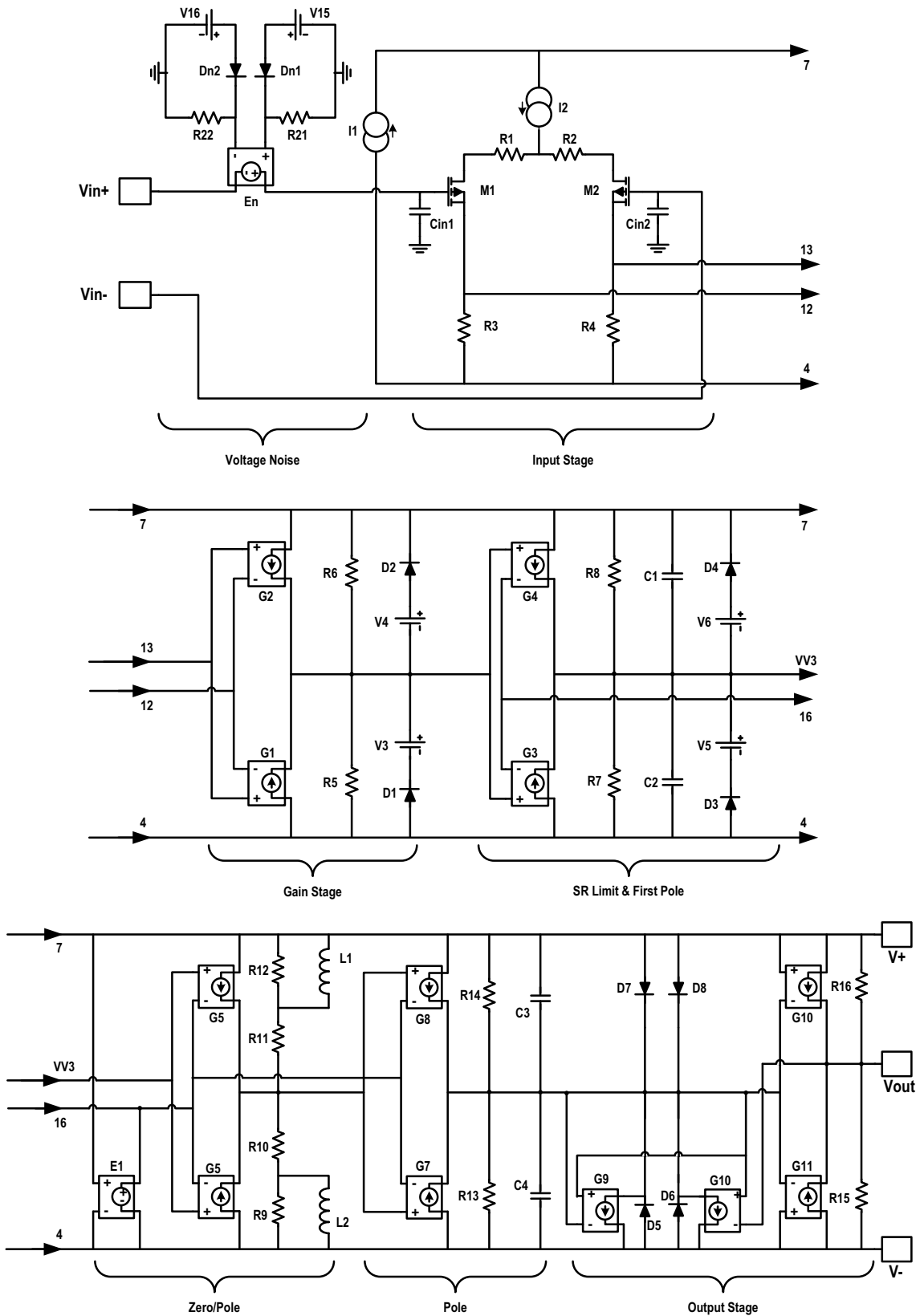

FIGURE 42. SPICE CIRCUIT SCHEMATIC

Characterization vs Simulation Results

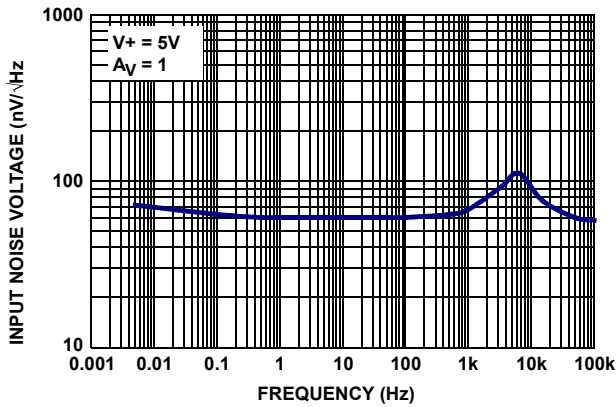

FIGURE 44. CHARACTERIZED INPUT NOISE VOLTAGE DENSITY vs FREQUENCY

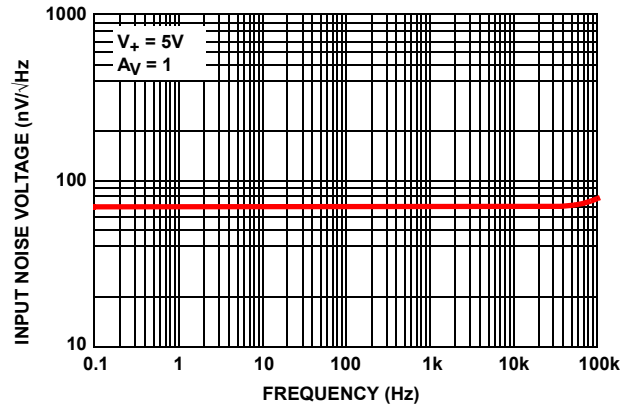

FIGURE 45. SIMULATED INPUT NOISE VOLTAGE DENSITY vs FREQUENCY

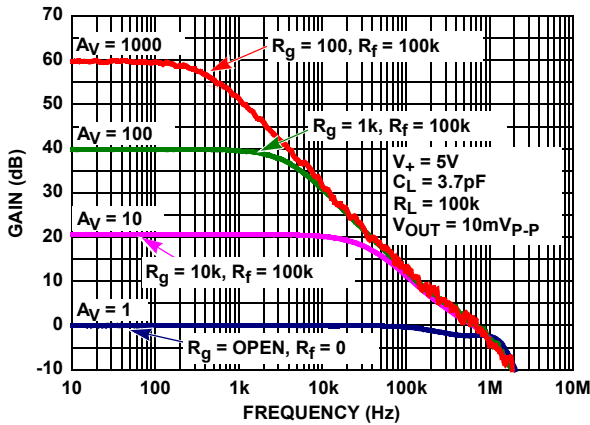

FIGURE 46. CHARACTERIZED FREQUENCY RESPONSE vs CLOSED LOOP GAIN

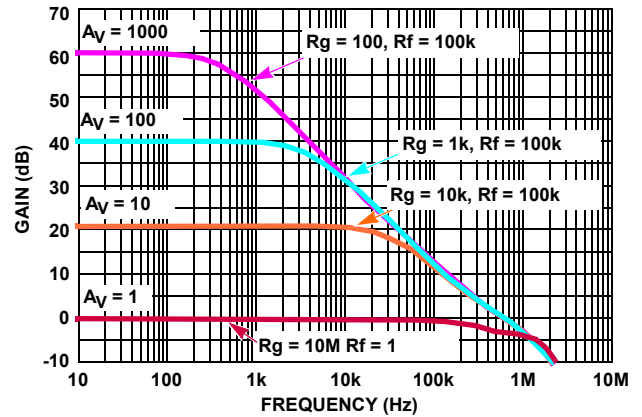

FIGURE 47. SIMULATED FREQUENCY RESPONSE vs CLOSED LOOP GAIN

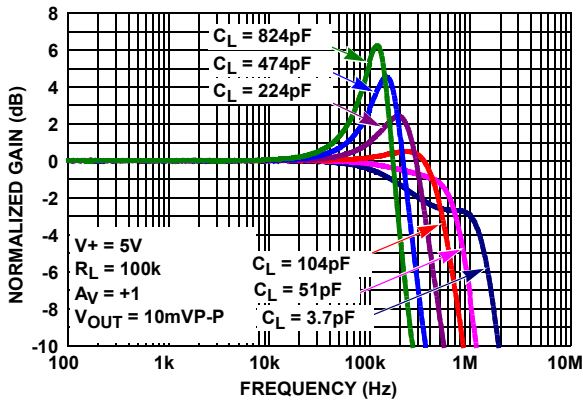

FIGURE 48. CHARACTERIZED GAIN vs FREQUENCY vs C_L

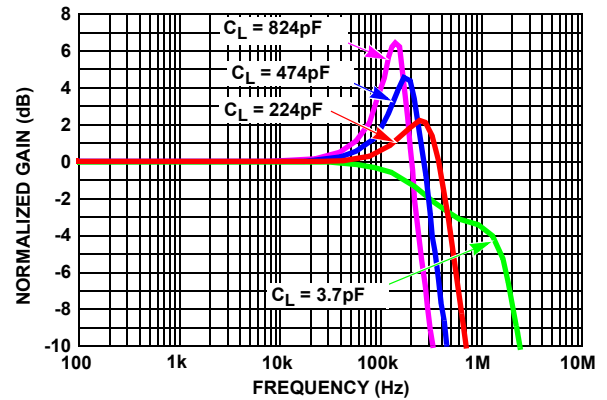

FIGURE 49. SIMULATED GAIN vs FREQUENCY vs C_L

Characterization vs Simulation Results (Continued)

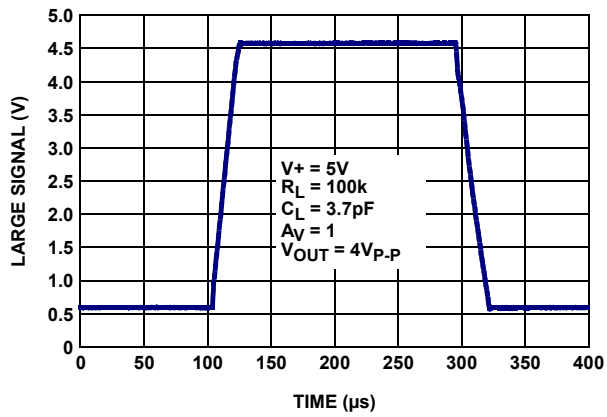

FIGURE 50. CHARACTERIZED LARGE SIGNAL STEP RESPONSE (4V)

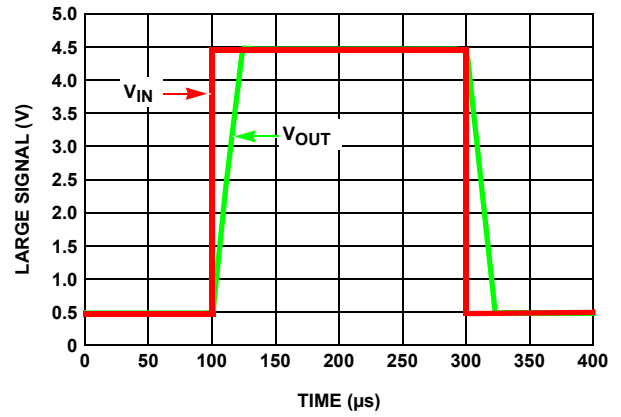

FIGURE 51. SIMULATED LARGE SIGNAL STEP RESPONSE (4V)

Revision History

The revision history provided is for informational purposes only and is believed to be accurate, but not warranted. Please go to web to make sure you have the latest Rev.

DATE	REVISION	CHANGE
5/31/11	FN7692.3	Changed minimum operating supply voltage from +1.65V to +1.8V throughout entire datasheet.
3/24/11		Added to Ordering Information Table on page 2 - ISL28233SOICEVAL1Z, ISL28433TSSOPEVAL1Z, ISL28433SOICEVAL1Z
12/2/10	FN7692.2	Added "Related Literature" on page 1 Removed "Coming Soon" from ISL28233FRZ device (8 Ld DFN) in "Ordering Information" on page 2. Corrected Thermal Pad Pin Name in "Pin Descriptions" on page 4 from "NC" to "PAD" Corrected θ_{JA} note for TDFN package in "Thermal Information" on page 5 from " θ_{JA} is measured with the component mounted on a high effective thermal conductivity test board in free air. See Tech Brief TB379 for details." To " θ_{JA} is measured in free air with the component mounted on a high effective thermal conductivity test board with "direct attach" features. See Tech Brief TB379." (since TDFN has thermal pad; TDFN package option not released yet)
10/27/10	FN7692.1	Changed Part Marking for ISL28233FUZ from 8233Z to 233FZ in "Ordering Information" table on page 2 Added ISL28233 in DFN package to Ordering Information" table on page 2. On page 6, removed Note 8. Changed note in MIN MAX columns of "Electrical Specifications" table from: "Parameters with MIN and/or MAX limits are 100% tested at +25°C, unless otherwise specified. Temperature limits established by characterization and are not production tested." To: "Compliance to datasheet limits is assured by one or more methods: production test, characterization and/or design."
8/25/10	FN7692.0	Initial Release.

Products

Intersil Corporation is a leader in the design and manufacture of high-performance analog semiconductors. The Company's products address some of the industry's fastest growing markets, such as, flat panel displays, cell phones, handheld products, and notebooks. Intersil's product families address power management and analog signal processing functions. Go to www.intersil.com/products for a complete list of Intersil product families.

*For a complete listing of Applications, Related Documentation and Related Parts, please see the respective device information page on intersil.com: [ISL28233, ISL28433](http://www.intersil.com/products)

To report errors or suggestions for this datasheet, please go to www.intersil.com/askourstaff

FITs are available from our website at <http://rel.intersil.com/reports/search.php>

© Copyright Intersil Americas LLC 2010-2011. All Rights Reserved.

All trademarks and registered trademarks are the property of their respective owners.

For additional products, see www.intersil.com/en/products.html

Intersil products are manufactured, assembled and tested utilizing ISO9001 quality systems as noted in the quality certifications found at www.intersil.com/en/support/qualandreliability.html

Intersil products are sold by description only. Intersil may modify the circuit design and/or specifications of products at any time without notice, provided that such modification does not, in Intersil's sole judgment, affect the form, fit or function of the product. Accordingly, the reader is cautioned to verify that datasheets are current before placing orders. Information furnished by Intersil is believed to be accurate and reliable. However, no responsibility is assumed by Intersil or its subsidiaries for its use; nor for any infringements of patents or other rights of third parties which may result from its use. No license is granted by implication or otherwise under any patent or patent rights of Intersil or its subsidiaries.

For information regarding Intersil Corporation and its products, see www.intersil.com

Package Outline Drawing L8.3x3J

8 LEAD DUAL FLAT NO-LEAD PLASTIC PACKAGE
Rev 0 9/09

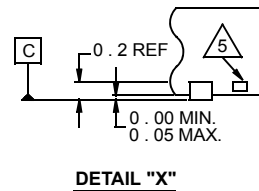
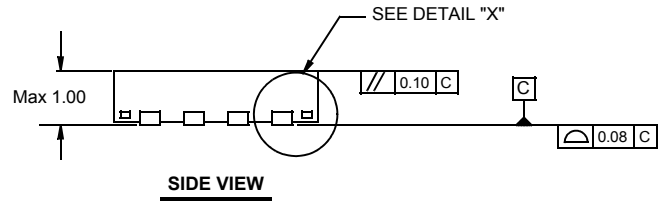
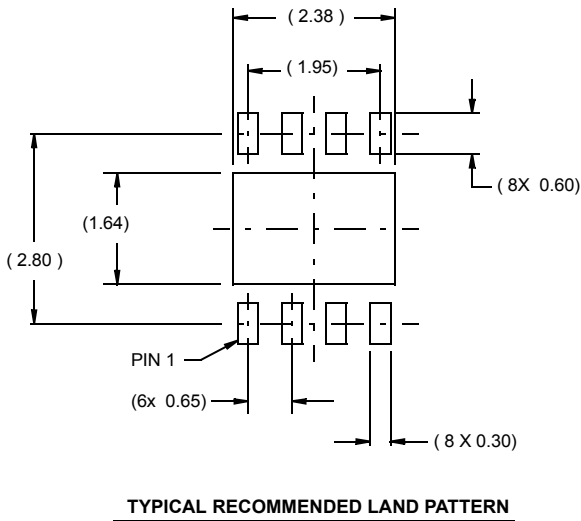
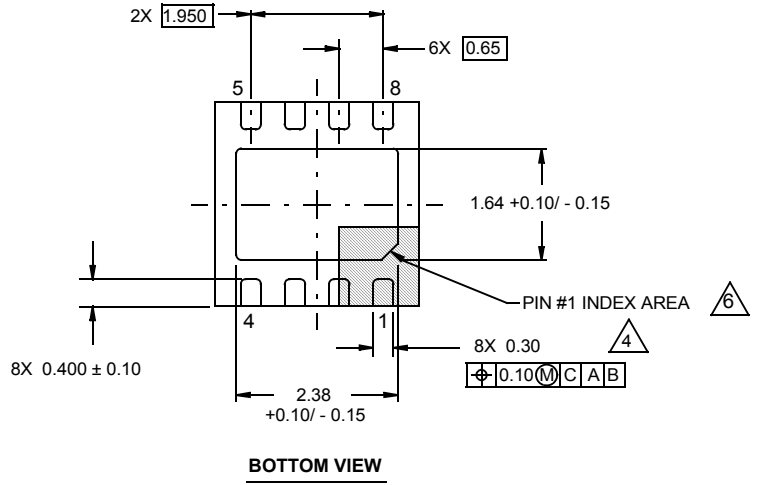
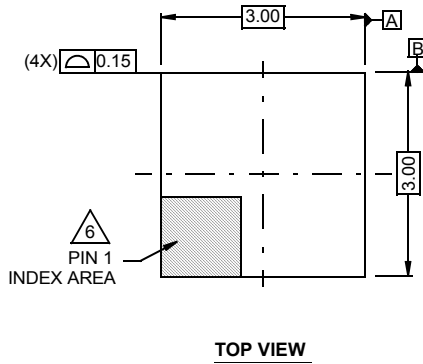

NOTES:

1. Dimensions are in millimeters.
Dimensions in () for Reference Only.
2. Dimensioning and tolerancing conform to AMSE Y14.5m-1994.
3. Unless otherwise specified, tolerance : Decimal ± 0.05
4. Dimension applies to the metallized terminal and is measured between 0.15mm and 0.30mm from the terminal tip.
5. Tiebar shown (if present) is a non-functional feature.
6. The configuration of the pin #1 identifier is optional, but must be located within the zone indicated. The pin #1 identifier may be either a mold or mark feature.

Package Outline Drawing

M8.15E

8 LEAD NARROW BODY SMALL OUTLINE PLASTIC PACKAGE

Rev 0, 08/09

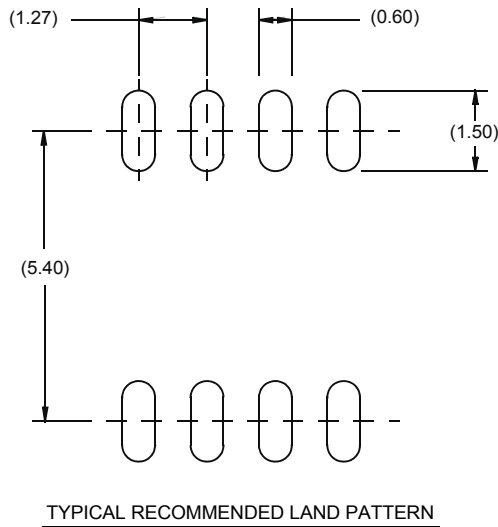
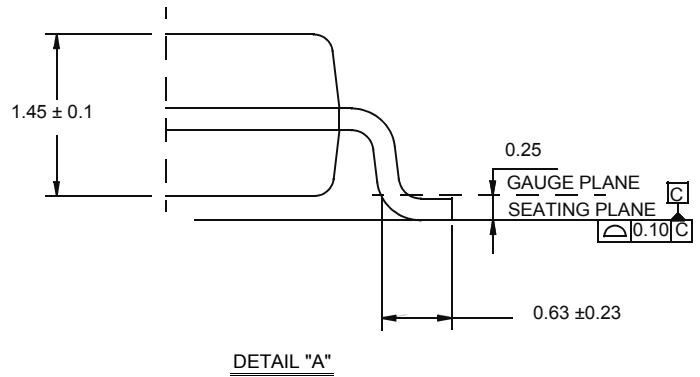
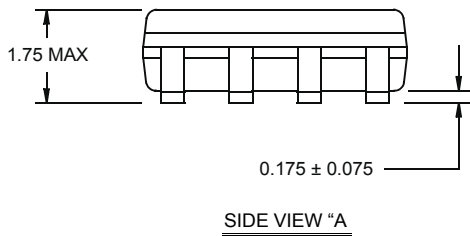
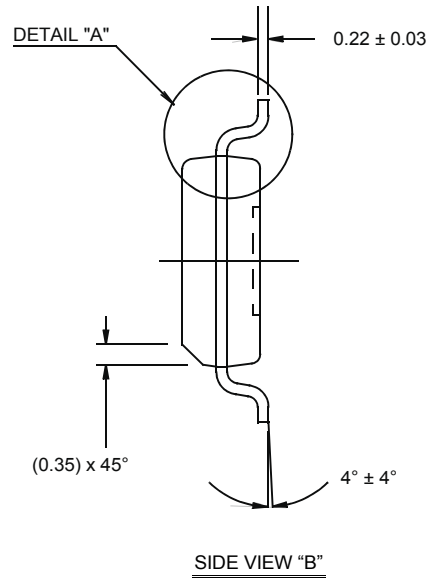
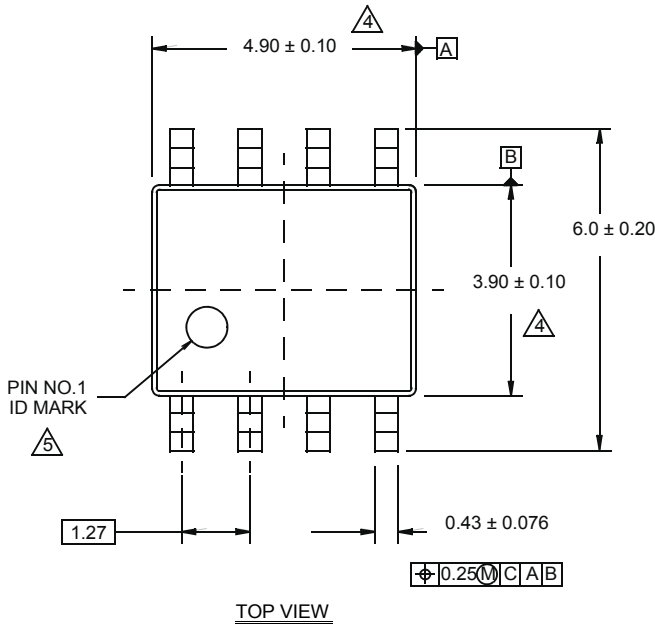

NOTES:

1. Dimensions are in millimeters.
Dimensions in () for Reference Only.
2. Dimensioning and tolerancing conform to AMSE Y14.5m-1994.
3. Unless otherwise specified, tolerance : Decimal ± 0.05
4. Dimension does not include interlead flash or protrusions.
Interlead flash or protrusions shall not exceed 0.25mm per side.
5. The pin #1 identifier may be either a mold or mark feature.
6. Reference to JEDEC MS-012.

Package Outline Drawing

M8.118A

8 LEAD MINI SMALL OUTLINE PLASTIC PACKAGE (MSOP)

Rev 0, 9/09

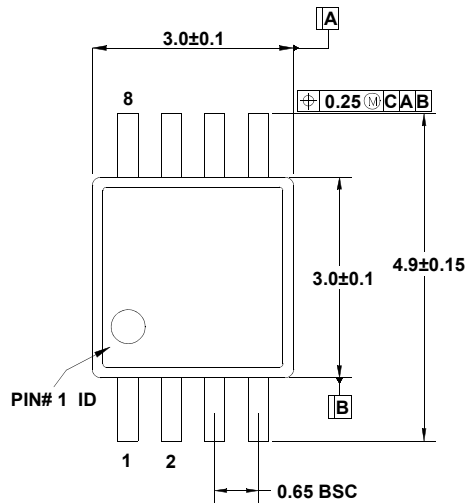

TOP VIEW

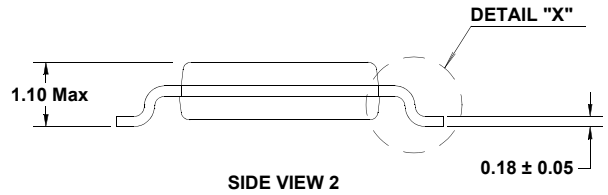

SIDE VIEW 2

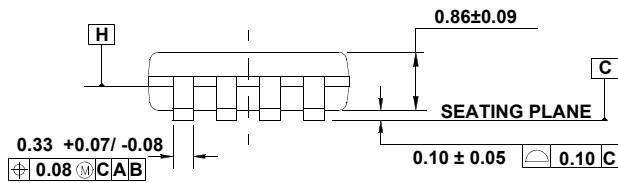

SIDE VIEW 1

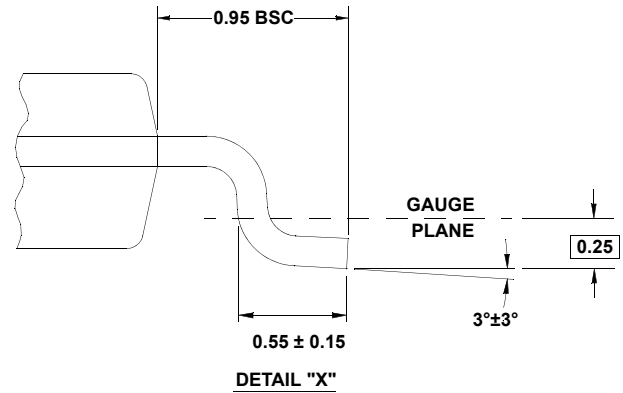

DETAIL "X"

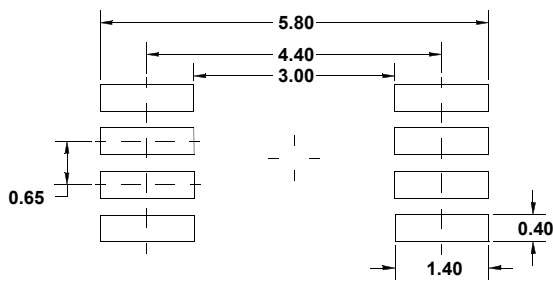

TYPICAL RECOMMENDED LAND PATTERN

NOTES:

1. Dimensions are in millimeters.
2. Dimensioning and tolerancing conform to JEDEC MO-187-AA and AMSE Y14.5m-1994.
3. Plastic or metal protrusions of 0.15mm max per side are not included.
4. Plastic interlead protrusions of 0.25mm max per side are not included.
5. Dimensions "D" and "E1" are measured at Datum Plane "H".
6. This replaces existing drawing # MDP0043 MSOP 8L.

Thin Shrink Small Outline Package Family (TSSOP)

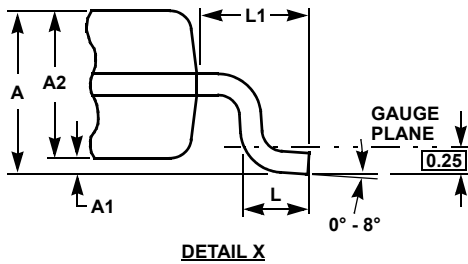
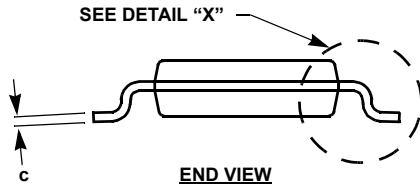
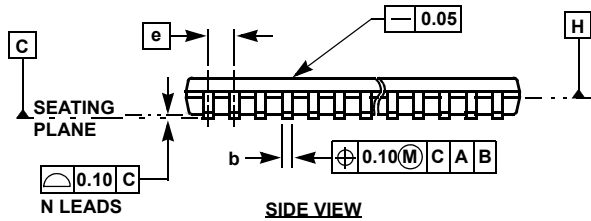
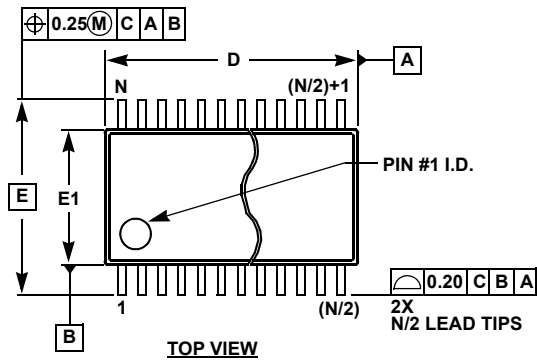

MDP0044

THIN SHRINK SMALL OUTLINE PACKAGE FAMILY

SYMBOL	MILLIMETERS					TOLERANCE
	14 LD	16 LD	20 LD	24 LD	28 LD	
A	1.20	1.20	1.20	1.20	1.20	Max
A1	0.10	0.10	0.10	0.10	0.10	±0.05
A2	0.90	0.90	0.90	0.90	0.90	±0.05
b	0.25	0.25	0.25	0.25	0.25	+0.05/-0.06
c	0.15	0.15	0.15	0.15	0.15	+0.05/-0.06
D	5.00	5.00	6.50	7.80	9.70	±0.10
E	6.40	6.40	6.40	6.40	6.40	Basic
E1	4.40	4.40	4.40	4.40	4.40	±0.10
e	0.65	0.65	0.65	0.65	0.65	Basic
L	0.60	0.60	0.60	0.60	0.60	±0.15
L1	1.00	1.00	1.00	1.00	1.00	Reference

Rev. F 2/07

NOTES:

1. Dimension "D" does not include mold flash, protrusions or gate burrs. Mold flash, protrusions or gate burrs shall not exceed 0.15mm per side.
2. Dimension "E1" does not include interlead flash or protrusions. Interlead flash and protrusions shall not exceed 0.25mm per side.
3. Dimensions "D" and "E1" are measured at dAtum Plane H.
4. Dimensioning and tolerancing per ASME Y14.5M-1994.

Small Outline Package Family (SO)

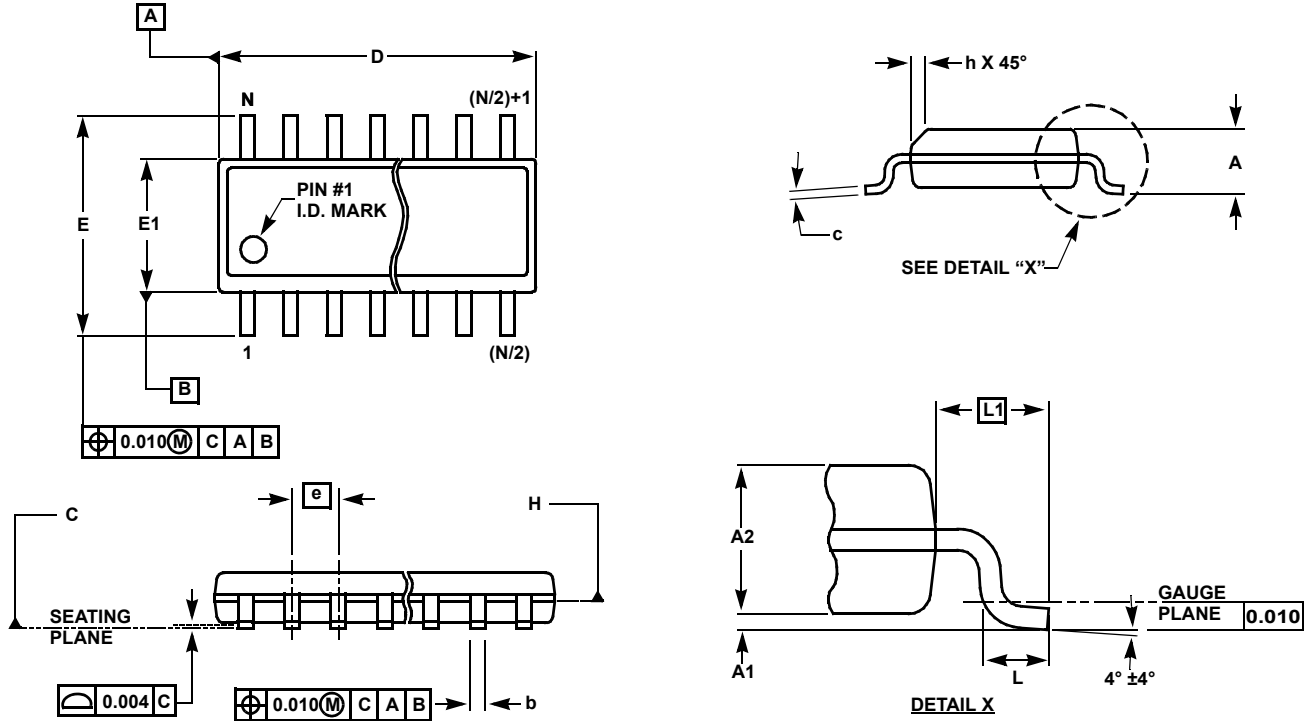

MDP0027

SMALL OUTLINE PACKAGE FAMILY (SO)

SYMBOL	INCHES							TOLERANCE	NOTES
	SO-8	SO-14	SO16 (0.150")	SO16 (0.300") (SOL-16)	SO20 (SOL-20)	SO24 (SOL-24)	SO28 (SOL-28)		
A	0.068	0.068	0.068	0.104	0.104	0.104	0.104	MAX	-
A1	0.006	0.006	0.006	0.007	0.007	0.007	0.007	±0.003	-
A2	0.057	0.057	0.057	0.092	0.092	0.092	0.092	±0.002	-
b	0.017	0.017	0.017	0.017	0.017	0.017	0.017	±0.003	-
c	0.009	0.009	0.009	0.011	0.011	0.011	0.011	±0.001	-
D	0.193	0.341	0.390	0.406	0.504	0.606	0.704	±0.004	1, 3
E	0.236	0.236	0.236	0.406	0.406	0.406	0.406	±0.008	-
E1	0.154	0.154	0.154	0.295	0.295	0.295	0.295	±0.004	2, 3
e	0.050	0.050	0.050	0.050	0.050	0.050	0.050	Basic	-
L	0.025	0.025	0.025	0.030	0.030	0.030	0.030	±0.009	-
L1	0.041	0.041	0.041	0.056	0.056	0.056	0.056	Basic	-
h	0.013	0.013	0.013	0.020	0.020	0.020	0.020	Reference	-
N	8	14	16	16	20	24	28	Reference	-

Rev. M 2/07

NOTES:

1. Plastic or metal protrusions of 0.006" maximum per side are not included.
2. Plastic interlead protrusions of 0.010" maximum per side are not included.
3. Dimensions "D" and "E1" are measured at Datum Plane "H".
4. Dimensioning and tolerancing per ASME Y14.5M-1994

Looking for pricing, stock, or lifecycle information?

Click below to explore more details on WIN SOURCE:

 [View ISL28433FBZ on WIN SOURCE](#)

 [Intersil Information](#)

Optimize Your Supply Chain with WIN SOURCE Solutions

-  Global Sourcing Solution
-  Obsolete Management
-  Cost Control Management
-  Shortage Management
-  Alternative Solution
-  Excess Inventory Management